

acer

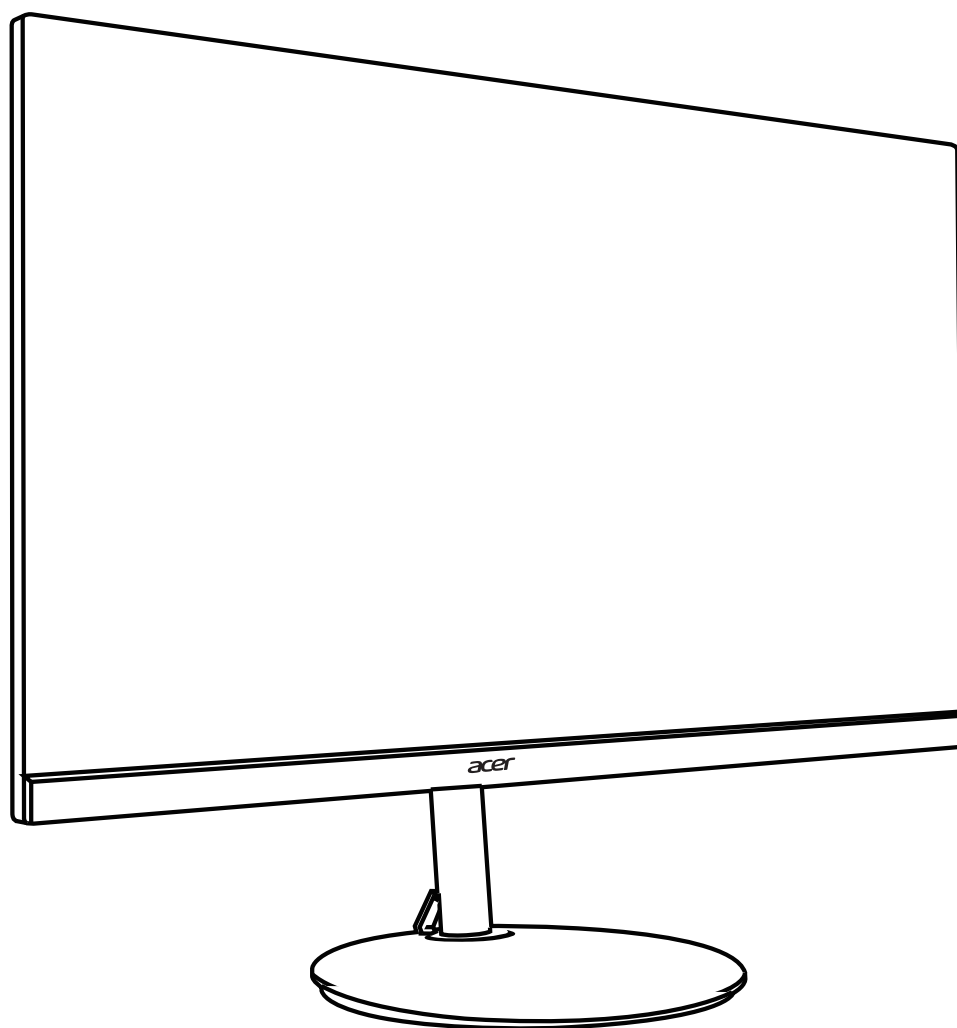

LCD monitor CB2 series-CB342CK

USER GUIDE





Acer LCD Monitor Quick Start Guide (QSG)

Important safety instructions

Please read the following instructions carefully.

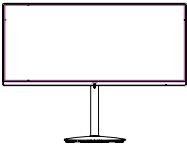
1. To clean the LCD monitor screen:
 - Turn off the LCD monitor and unplug the power cord.
 - Spray a non-solvent cleaning solution onto a rag and clean the screen gently.
2. Do not place the LCD monitor near a window. Exposing the monitor to rain, moisture or sunlight can severely damage it.
3. Do not apply pressure to the LCD screen. Excessive pressure may cause permanent damage to the display.
4. Do not remove the cover or attempt to service this unit yourself. An authorized technician should perform servicing of any nature.
5. Store the LCD monitor in a room with a temperature of -20° to 60°C (-4° to 140°F). Storing the LCD monitor outside this range may result in permanent damage.
6. Immediately unplug your monitor and call an authorized technician if any of the following circumstances occur:
 - Monitor-to-PC signal cable is frayed or damaged.
 - Liquid spills onto the LCD monitor or the monitor is exposed to rain.
 - The LCD monitor or case is damaged.

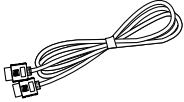
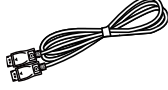
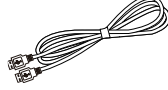
Package contents

LCD monitor	Power cord	HDMI cable (optional)	DP cable (optional)	USB cable (optional)	Quick start guide
					

Attaching the monitor to the stand

1. Remove the monitor bracket and base from the packaging and place it on a stable and level workspace.
2. Remove the monitor from the packaging, by aligning the front-end of the bracket with the corresponding screw holes on the back of the display, Replace the four screws that secure the monitor to the bracket . Tighten the screws firmly.
3. Attach the footstand to the base. Turn clockwise to lock. Ensure that the base is locked onto the stand.
4. Secure the base to the stand by turning the screw using the integrated tab or a suitable coin.

Connecting your monitor to a computer

1. Turn off your computer and unplug your computer's power cord.
2. Connect the signal cable to the DP (optional) and/or HDMI (optional) input socket of the monitor, and the DP (optional) and/or HDMI (optional) output socket of the graphics card on the computer. Then tighten the thumbscrews on the signal cable connector.
3. USB Upstream /USB Downstream (Battery Charger) /USB Downstream

Connect one end of the USB cable to the USB terminal of the monitor, and connect the other end of the USB cable to an appropriate USB port on your device.

Note: The USB downstream port does not provide power while the monitor switch is off.

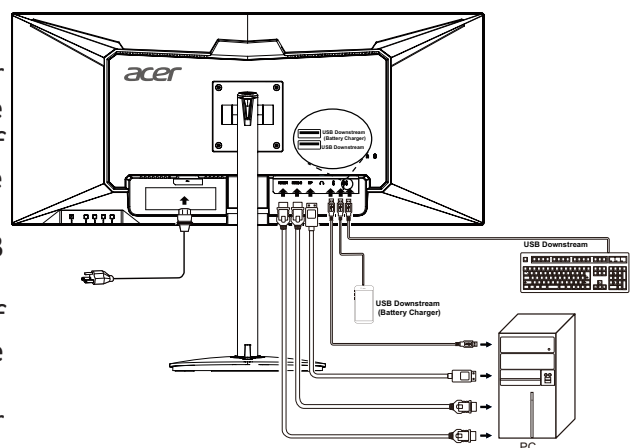





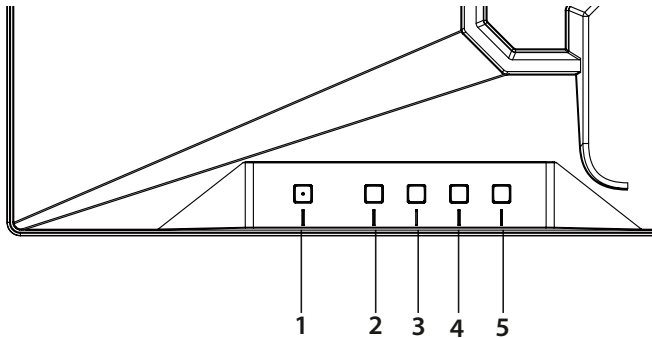

Note: In some circumstances when using USB 3.0 devices (hard drives or flash drives) and 2.4GHz USB wireless devices (for example wireless mouse, keyboard, or headphone) at the same time, USB 3.0 devices radio frequency interference may impact on 2.4GHz USB wireless devices, result in a drop in throughput on the wireless transmission. User may feel delayed response to mouse or keyboard inputs, missing keyboard characters or mouse commands, decreased operating distance between the 2.4 GHz USB wireless device and its receiver.

Please refer to the following ways which helps to reduce this radio frequency interference.

1. Wireless dongle was moved away from the USB 3.0 device as possible as you can.
2. If the USB wireless receiver and USB 3.0 device have to be connected at the same side, Position your USB wireless receiver as close as possible to your wireless peripheral device (mouse, keyboard, headphones, etc.) Or use a standard USB extender cable or Hub to position your USB wireless receiver as far away as possible from your USB 3.0 port.
4. Insert the monitor power cable into the power port at the back of the monitor.
5. Plug the power cords of your computer and your monitor.



External controls

1		Power button	Turns the monitor on/off.
2		OSD functions/ Down/Right	a. Press to view the OSD. b. Press this button to select the desired item when in OSD menu.
3		Input source switching/Up/Left	a. Use the INPUT hotkey to enter Input select function. b. Press this button to select the desired item when in OSD menu.
4		Volume Key	Press this button to adjust volume.
		Enter	a. Press to enter a selection in the OSD. b. When OSD Lock push 3 seconds Lock function is disabled
5		Empowering Key	Press this button to select scenario mode.
		Exit	When the OSD menu is active, this button will act as the exit key (exit OSD menu).

Regulations and safety notices

FCC notices

This device has been tested and found to comply with the limits for a Class B digital device pursuant to Part 15 of the FCC rules. These limits are designed to provide reasonable protection against harmful interference in a residential installation. This device generates, uses, and can radiate radio frequency energy and, if not installed and used in accordance with the instructions, may cause harmful Interference to radio communications. However, there is no guarantee that interference will not occur in a particular installation. If this device does cause harmful interference to radio or television reception, which can be determined by turning the device off and on, the user is encouraged to try to correct the interference by one or more of the following measures:

- Reorient or relocate the receiving antenna.
- Increase the separation between the device and receiver.
- Connect the device into an outlet on a circuit different from that to which the receiver is connected.

- Consult the dealer or an experienced radio/television technician for help.

CE declaration of conformity

Hereby, Acer Inc., declares that this LCD monitor is in compliance with the essential requirements and other relevant provisions of EMC Directive 2014/30/EU, Low Voltage Directive 2014/35/EU, and RoHS Directive 2011/65/EU and Directive 2009/125/EC with regard to establishing a framework for the setting of ecodesign requirements for energy-related product.

Notice: Shielded cables

All connections to other computing devices must be made using shielded cables to maintain compliance with EMC regulations.

Notice: Peripheral devices

Only peripherals (input/output devices, terminals, printers, etc.) certified to comply with the Class B limits may be attached to this equipment. Operation with non-certified peripherals is likely to result in interference to radio and TV reception.

Caution

Changes or modifications not expressly approved by the manufacturer could void the user authority, which is granted by the Federal Communications Commission, to operate this product.

Operation conditions

This device complies with Part 15 of the FCC Rules. Operation is subject to the following two conditions: (1) this device may not cause harmful interference, and (2) this device must accept any interference received, including interference that may cause undesired operation.

Notice: Canadian users

CAN ICES-3(B)/NMB-3(B)



Disposal of waste equipment by user in private household in the European Union

This symbol on the product or on its packaging indicates that this product must not be disposed of with your other household waste. Instead, it is your responsibility to dispose of your waste equipment by handing it over to a designated collection point for the recycling of waste electrical and electronic equipment. The separate collection and recycling of your waste equipment at the time of disposal will help to conserve natural resources and ensure that it is recycled in a manner that protects human health and the environment. For more information about where you can drop off your waste equipment for recycling, please contact your local city office, your household waste disposal service or the shop where you purchased the product.

*Acer monitor is purposed for video and visual display of information obtained from electronic devices.

SPECIFICATIONS

LCD Panel	Driving system	TFT Color LCD	
	Size	34"W(87cm)	
	Pixel pitch	0.2325(H) x 0.2325(V) mm	
	Brightness (cd/m ²)	250 (Typ)	
	Contrast	100,000,000:1 Max (ACM)	
	Viewable angle	CR=10, 178°(H), 178°(V)	
	Response time	1ms(VRB)	
	Panel Type	In-Plane Switching	
H-Frequency		15KHz-114KHz	
V-Frequency		48Hz-76Hz	
Display Colors		16.7M (8bits)	
Dot Clock		600 MHz	
Max. Resolution		3440x1440@75Hz	
Plug & Play		VESA DDCCI/DDC2B	
Energy Efficiency Class		A	
*Annual Energy Consumption		50 (kWh) (for HDMI-input Model)	
Power consumption (at 200 nits)	On Mode	50W (typical)	
	Sleep Mode	0.5W (typical)	
	Off Mode	0.5W (typical)	
Input Connector		DP/HDMI	
Input Video Signal		DP signal/HDMI signal	
Speakers		3Wx2	
Maximum Screen Size	Horizontal	799.8 mm	
	Vertical	334.8 mm	
Power Source		100-240V~, 50/60Hz	
Environmental Considerations		Operating Temp: 0° to 40°C Storage Temp: -20° to 60°C Operating Humidity: 20% to 80%	
Dimensions (W x H x D)		817x597~447x 269mm	
Weight (N. W.)		8.7kg (net)	
Mechanism specifications		Tilt: -5° to +35° (At the highest position) Swivel: Yes Height adjustment: Yes	Pivot: No Detachable foot stand: Yes

	Buttons	Power Button Menu Input	Volume/Enter E(Empowering) Key/Exit
External Controls	Functions	Picture Brightness Contrast Black Boost BlueLight ACM HDR Super Sharpness Gamma Color Temp. Modes sRGB mode Grayscale Mode 6-axis Hue 6-axis Saturate Audio Volume Mute Performance Over Drive FreeSync Refresh Rate Num VRB Ultra Low Latency	OSD Language OSD Timeout Transparency OSD Lock System Input Auto Source DP Format Wide Mode PIP/PBP Hot Key Assignment DDC/CI HDMI Black Level Quick Start Mode Information Reset All Settings Exit Save Settings to ..

*All specifications are subject to change without notice.

Regulatory Compliance



Find manuals and other documents for your Acer product on the official Acer support website.

*Annual energy consumption is calculated using the typical power consumption 4 hours per day, 365 days per year.