

acer

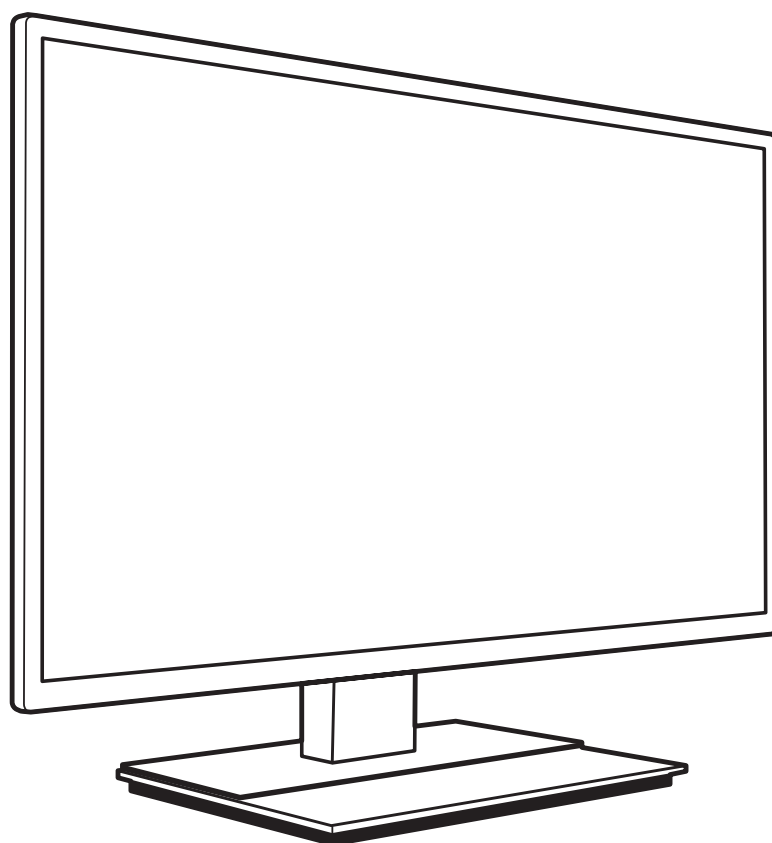

LCD monitor EB1 series-EB321HQU

USER GUIDE





Acer LCD Monitor Quick Start Guide (QSG)

Important safety instructions

Please read the following instructions carefully.

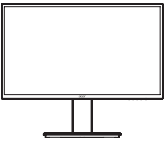
1. To clean the LCD monitor screen:
 - Turn off the LCD monitor and unplug the power cord.
 - Spray a non-solvent cleaning solution onto a rag and clean the screen gently.
2. Do not place the LCD monitor near a window. Exposing the monitor to rain, moisture or sunlight can severely damage it.
3. Do not apply pressure to the LCD screen. Excessive pressure may cause permanent damage to the display.
4. Do not remove the cover or attempt to service this unit yourself. An authorized technician should perform servicing of any nature.
5. Store the LCD monitor in a room with a temperature of -20° to 60° C (-4° to 140° F). Storing the LCD monitor outside this range may result in permanent damage.
6. Immediately unplug your monitor and call an authorized technician if any of the following circumstances occur:
 - Monitor-to-PC signal cable is frayed or damaged.
 - Liquid spills onto the LCD monitor or the monitor is exposed to rain.
 - The LCD monitor or case is damaged.

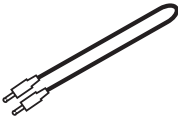
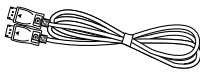
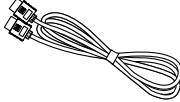
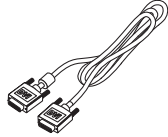
Package contents

LCD monitor	Power cord	Audio cable (optional)	DP cable (optional)	HDMI cable (optional)	DVI-DL cable (optional)	Quick start guide
						

Attaching the monitor to the stand

1. Remove the monitor from the packaging.
2. Attach the footstand to the base.
3. Turn clockwise to lock. Ensure that the base is locked onto the stand.
4. Secure the base to the stand by turning the screw using the integrated tab or a suitable coin.

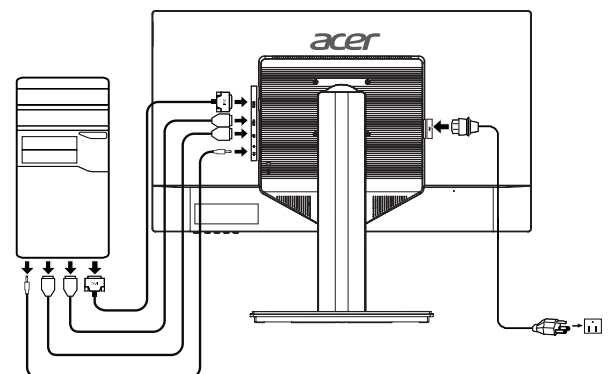

Connecting your monitor to a computer

1. Turn off your computer and unplug your computer's power cord.
2. Connect the signal cable to the DVI-DL (optional) and/or DP (optional) and/or HDMI (optional) input socket of the monitor, and the DVI-DL (optional) and/or DP (optional) and/or HDMI (optional) output socket of the graphics card on the computer. Then tighten the thumbscrews on the signal cable connector.
3. Optional: Connect the audio input socket (AUDIO IN) of the LCD monitor and the line-out port on the computer with the audio cable.
4. Insert the monitor power cable into the power port at the back of the monitor.
5. Plug the power cords of your computer and your monitor into a nearby electrical outlet.

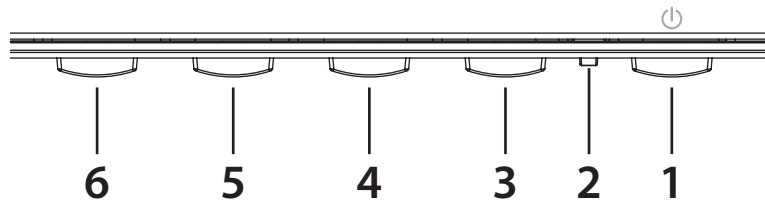



External controls

1 & 2		LED Indicator / Power button	Turns the monitor on/off. Blue indicates power on. Amber indicates standby/ power saving mode.
3	Shortcut menu	Shortcut menu change	When the shortcut menu appears, this button is used to switch around.
	Exit	Exit	When the OSD menu is active, this button will act as the exit key (exit OSD menu).
4	Menu / Enter	OSD functions	Press to view the OSD. Press again to enter a selection in the OSD.
5	PIP / ^	Picture in picture hotkey / Up	a. Use the PIP hotkey to active the picture-in-picture function. b. Press this button to select the desired item when in OSD menu.
	INPUT	Input source switching	a. Use the INPUT hotkey to enter Input select function. b. Press this button to select the desired item when in OSD menu.
6		Empowering Key / Down	a. Press this button to select scenario mode. b. Press this button to select the desired item when in OSD menu.
		Volume Key	a. Press this button to adjust volume. (only Earphone Mode) b. Press this button to select the desired item when in OSD menu.

Regulations and safety notices

FCC notices

This device has been tested and found to comply with the limits for a Class B digital device pursuant to Part 15 of the FCC rules. These limits are designed to provide reasonable protection against harmful interference in a residential installation. This device generates, uses, and can radiate radio frequency energy and, if not installed and used in accordance with the instructions, may cause harmful Interference to radio communications. However, there is no guarantee that interference will not occur in a particular installation. If this device does cause harmful interference to radio or television reception, which can be determined by turning the device off and on, the user is encouraged to try to correct the interference by one or more of the following measures:

- Reorient or relocate the receiving antenna.
- Increase the separation between the device and receiver.
- Connect the device into an outlet on a circuit different from that to which the receiver is connected.
- Consult the dealer or an experienced radio/television technician for help.

CE declaration of conformity

Hereby, Acer Inc., declares that this LCD monitor is in compliance with the essential requirements and other relevant provisions of EMC Directive 2014/30/EU, Low Voltage Directive 2014/35/EU, and RoHS Directive 2011/65/EU and Directive 2009/125/EC with regard to establishing a framework for the setting of ecodesign requirements for energy-related product.

Notice: Shielded cables

All connections to other computing devices must be made using shielded cables to maintain compliance with EMC regulations.

Notice: Peripheral devices

Only peripherals (input/output devices, terminals, printers, etc.) certified to comply with the Class B limits may be attached to this equipment. Operation with non-certified peripherals is likely to result in interference to radio and TV reception.

Caution

Changes or modifications not expressly approved by the manufacturer could void the user authority, which is granted by the Federal Communications Commission, to operate this product.

Operation conditions

This device complies with Part 15 of the FCC Rules. Operation is subject to the following two conditions: (1) this device may not cause harmful interference, and (2) this device must accept any interference received, including interference that may cause undesired operation.

Notice: Canadian users

CAN ICES-3(B)/NMB-3(B)



Disposal of waste equipment by user in private household in the European Union

This symbol on the product or on its packaging indicates that this product must not be disposed of with your other household waste. Instead, it is your responsibility to dispose of your waste equipment by handing it over to a designated collection point for the recycling of waste electrical and electronic equipment. The separate collection and recycling of your waste equipment at the time of disposal will help to conserve natural resources and ensure that it is recycled in a manner that protects human health and the environment. For more information about where you can drop off your waste equipment for recycling, please contact your local city office, your household waste disposal service or the shop where you purchased the product.

*Acer monitor is purposed for video and visual display of information obtained from electronic devices.

SPECIFICATIONS

LCD Panel	Driving system	TFT Color LCD	
	Size	31.5"W(80cm)	
	Pixel pitch	0.273(H) x 0.273(V) mm	
	Brightness (cd/m ²)	300 (Typ)	
	Contrast	100,000,000:1 Max (ACM)	
	Viewable angle	CR=10, 178°(H), 178°(V)	
	Response time	4ms (G to G)	
	Panel Type	In-Plane Switching	
	Video	R, G, B	
	H-Frequency	30KHz-100KHz	
	V-Frequency	50Hz-75Hz	
Display Colors		1.07B(8bit+FRC)	
Dot Clock		148.5 MHz	
Max. Resolution		2560 x 1440@60Hz	
Plug & Play		VESA DDC/CI/DCC2B	
Energy Efficiency Class		A	
*Annual Energy Consumption		50 (kWh) (for HDMI-input Model)	
Power consumption (at 300 nits)	On Mode	42W(typical)	
	Sleep Mode	0.5W(typical)	
	Off Mode	0.48W(typical)	
Input Connector		DP (Only DP-Input Model) HDMI (Only HDMI Model) DVI-DL 24pin (Only Dual-Input Model)	
Input Video Signal		Digital signal (Only Dual-Input Model) DP signal (Only DP Model) HDMI signal (Only HDMI Model)	
Speakers		3W x 2(Only Audio-Input Model)	
Maximum Screen Size	Horizontal	698.112mm	
	Vertical	392.688mm	
Power Source		100-240V~, 50/60Hz	
Environmental Considerations		Operating Temp: 0° to 40°C Storage Temp: -20° to 60°C Operating Humidity: 20% to 80%	
Dimensions (W x H x D)		725.9 x 457~597 x 266.5mm	
Weight (N. W.)		10.1kg (net)	
Mechanism specifications		Tilt: - 5° to +25° Swivel: Yes Height adjustment: Yes	Pivot: No Detachable foot stand: Yes
External Controls	Buttons	Power Button Page Left /Right/Exit Menu/Enter	PIP / Input E(Empowering) Key/ Volume
	Functions	Acer eColor Management BlueLight Brightness Contrast Colour Temp sRGB mode Gamma Super Sharpness 6-axis Hue 6-axis Saturate Language	OSD Timeout Wide Mode DDC/CI On/Off ACM On/Off Input OD Quick Start Mode PIP/PBP Reset Information

*All specifications are subject to change without notice.

Regulatory Compliance



Find manuals and other documents for your Acer product on the official Acer support website.

*Annual energy consumption is calculated using the typical power consumption 4 hours per day, 365 days per year.