



**THE DISPLAY CHOICE
OF PROFESSIONALS™**

LA-22, LA-24 & LA-27 LED-Backlit Display

www.agneovo.com

User Manual

TABLE OF CONTENTS

SAFETY INFORMATION

Federal Communications Commission (FCC) Notice (U.S. Only)	3
WEEE	3

PRECAUTIONS

Notice	4
Cautions When Setting Up	4
Cautions When Using	5
Cleaning and Maintenance	6
Notice for the LCD Display	6

CHAPTER 1: PRODUCT DESCRIPTION

1.1 Package Contents	7
1.2 Installation	8
1.2.1 Installing the Stand	8
1.2.2 Adjusting the Tilt	9
1.2.3 Wall Mounting	9
1.3 Overview	11
1.3.1 Front View	11
1.3.2 Control Buttons	12
1.3.3 Rear View	14

CHAPTER 2: MAKING CONNECTIONS

2.1 Connecting the AC Power	15
2.2 Connecting Input Source Signals	16
2.3 Connecting Audio Devices	17

CHAPTER 3: ON SCREEN DISPLAY MENU

3.1 Using the OSD Menu	18
3.2 OSD Menu Tree	19

CHAPTER 4: ADJUSTING THE LCD DISPLAY

4.1 Colour Setting	21
4.2 Picture Setting	22
4.3 OSD Setting	23
4.4 Other Setting	24
4.5 Reset Setting	25

CHAPTER 5: APPENDIX

5.1 Warning Messages	26
5.2 Troubleshooting	27
5.3 Transporting the LCD Display	28

CHAPTER 6: SPECIFICATIONS

6.1 Display Specifications	30
6.2 Display Dimensions	31

SAFETY INFORMATION

Federal Communications Commission (FCC) Notice (U.S. Only)



This equipment has been tested and found to comply with the limits for a Class B digital device, pursuant to part 15 of the FCC Rules. These limits are designed to provide reasonable protection against harmful interference in a residential installation. This equipment generates, uses and can radiate radio frequency energy and, if not installed and used in accordance with the instructions, may cause harmful interference to radio communications. However, there is no guarantee that interference will not occur in a particular installation. If this equipment does cause harmful interference to radio or television reception, which can be determined by turning the equipment off and on, the user is encouraged to try to correct the interference by one or more of the following measures:

- Reorient or relocate the receiving antenna.
- Increase the separation between the equipment and receiver.
- Connect the equipment into an outlet on a circuit different from that to which the receiver is connected.
- Consult the dealer or an experienced radio/TV technician for help.



Changes or modifications not expressly approved by the party responsible for compliance could void the user's authority to operate the equipment.

Use only an RF shielded cable that was supplied with the display when connecting this display to a computer device.

To prevent damage which may result in fire or shock hazard, do not expose this appliance to rain or excessive moisture.

THIS CLASS B DIGITAL APPARATUS MEETS ALL REQUIREMENTS OF THE CANADIAN INTERFERENCE-CAUSING EQUIPMENT REGULATIONS.



This device complies with Part 15 of the FCC Rules. Operation is subject to the following two conditions: (1) this device may not cause harmful interference, and (2) this device must accept any interference received, including interference that may cause undesired operation.

WEEE

Information for users applicable in European Union countries

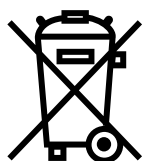

The symbol on the product or its packaging signifies that this product has to be disposed separately from ordinary household wastes at its end of life. Please kindly be aware that this is your responsibility to dispose electronic equipment at recycling centers so as to help conserve natural resources. Each country in the European Union should have its collection centers for electrical and electronic equipment recycling. For information about your recycling drop off area, please contact your local related electrical and electronic equipment waste management authority or the retailer where you bought the product.

PRECAUTIONS

PRECAUTIONS

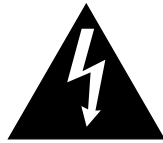

CAUTION
RISK OF ELECTRIC SHOCK
DO NOT OPEN



Symbols used in this manual



This icon indicates the existence of a potential hazard that could result in personal injury or damage to the product.



This icon indicates important operating and servicing information.

Notice

- Read this User Manual carefully before using the LCD display and keep it for future reference.
- The product specifications and other information provided in this User Manual are for reference only. All information is subject to change without notice. Updated content can be downloaded from our web site at www.agneovo.com.
- To protect your rights as a consumer, do not remove any stickers from the LCD display. Doing so may affect the determination of the warranty period.

Cautions When Setting Up



Do not place the LCD display near heat sources, such as a heater, exhaust vent, or in direct sunlight.



Do not cover or block the ventilation holes in the housing.



Place the LCD display on a stable area. Do not place the LCD display where it may be subject to vibration or shock.



Place the LCD display in a well-ventilated area.



Do not place the LCD display outdoors.



Do not place the LCD display in a dusty or humid environment.



Do not spill liquid or insert sharp objects into the LCD display through the ventilation holes. Doing so may cause accidental fire, electric shock or damage the LCD display.

PRECAUTIONS

Cautions When Using



Use only the power cord supplied with the LCD display.



The power outlet should be installed near the LCD display and be easily accessible.



If an extension cord is used with the LCD display, ensure that the total current consumption plugged into the power outlet does not exceed the ampere rating.



Do not allow anything to rest on the power cord. Do not place the LCD display where the power cord may be stepped on.



If the LCD display will not be used for an indefinite period of time, unplug the power cord from the power outlet.



To disconnect the power cord, grasp and pull by the plug head. Do not tug on the cord; doing so may cause fire or electric shock.



Do not unplug or touch the power cord with wet hands.



WARNING:

Unplug the power cord from the power outlet and refer to qualified service personnel under the following conditions:



- When the power cord is damaged.
- If the LCD display has been dropped or the housing has been damaged.
- If the LCD display emits smoke or a distinct odor.



Ceiling mount or mount on any other horizontal surface overhead are not advisable.



WARNING:

Installation in contravention of the instructions may result in undesirable consequences, particularly hurting people and damaging property. Users who have already mounted the display on the ceiling or any other horizontal surface overhead are strongly advised to contact AG Neovo for consultations and solutions to help ensure a most pleasurable and fulfilling display experience.

PRECAUTIONS

Cleaning and Maintenance



Do not attempt to service the LCD display yourself, refer to qualified service personnel.

Opening or removing the covers may expose you to dangerous voltage or other risks.

Notice for the LCD Display

In order to maintain the stable luminous performance, it is recommended to use low brightness setting.

Due to the lifespan of the lamp, it is normal that the brightness quality of the LCD display may decrease with time.

When static images are displayed for long periods of time, the image may cause an imprint on the LCD display. This is called image retention or burn-in.

To prevent image retention, do any of the following:

- Set the LCD display to turn off after a few minutes of being idle.
- Use a screen saver that has moving graphics or a blank white image.
- Switch desktop backgrounds regularly.
- Adjust the LCD display to low brightness settings.
- Turn off the LCD display when the system is not in use.

Things to do when the LCD display shows image retention:

- Turn off the LCD display for extended periods of time. It can be several hours or several days.
 - Use a screen saver and run it for extended periods of time.
 - Use a black and white image and run it for extended periods of time.
-

There are millions of micro transistors inside the LCD display. It is normal for a few transistors to be damaged and to produce spots. This is acceptable and is not considered a failure.

CHAPTER 1: PRODUCT DESCRIPTION

1.1 Package Contents

When unpacking, check if the following items are included in the package. If any of them is missing or damaged, contact your dealer.

LCD Display

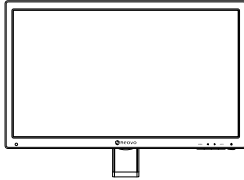

LA-22

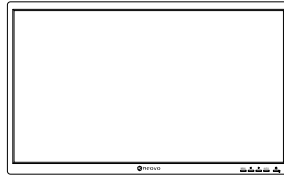

LA-24

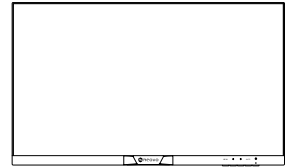

LA-27

Quick Start Guide

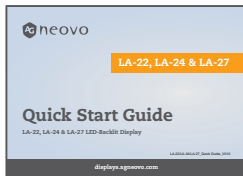

Base

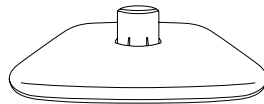

LA-22

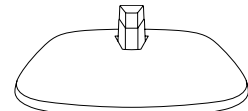

LA-24/LA-27

Stand
(for LA-24/LA-27)

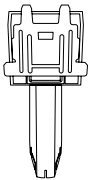

Power Cord

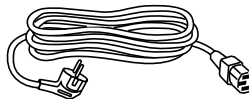

VGA Cable

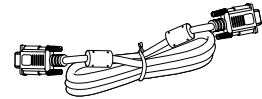

Audio Cable

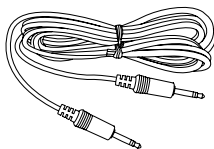

Warranty Card

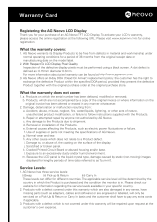

Note:

- Use only the supplied power cord.
- The above pictures are for reference only. Actual items may vary upon shipment.

PRODUCT DESCRIPTION

1.2 Installation

1.2.1 Installing the Stand

1. Place the LCD display with the screen side down on a cushioned surface.
2. Attach the stand to the LCD display.
 - a. Press firmly on the base to secure the latches on the base into the slots on the stand.
 - b. Attach the stand to the base mount. (LA-24, LA-27 model)

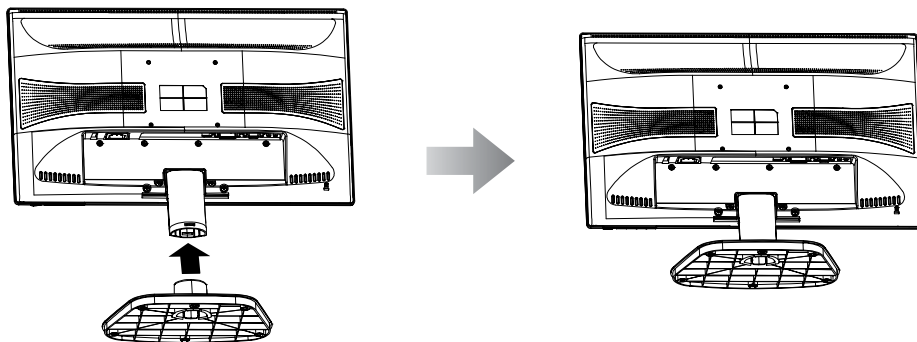

LA-22

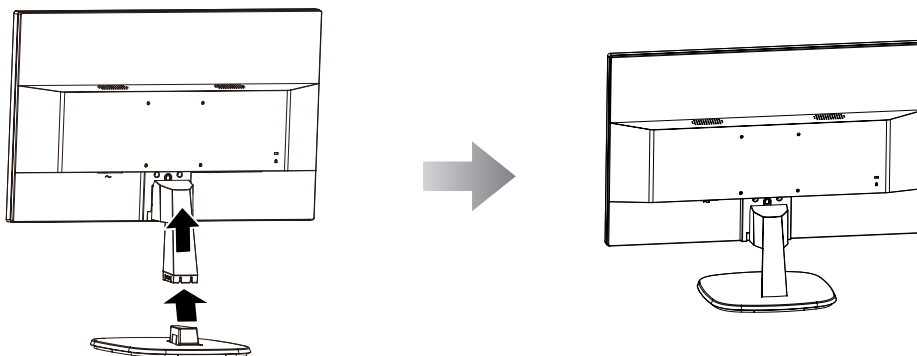

LA-24

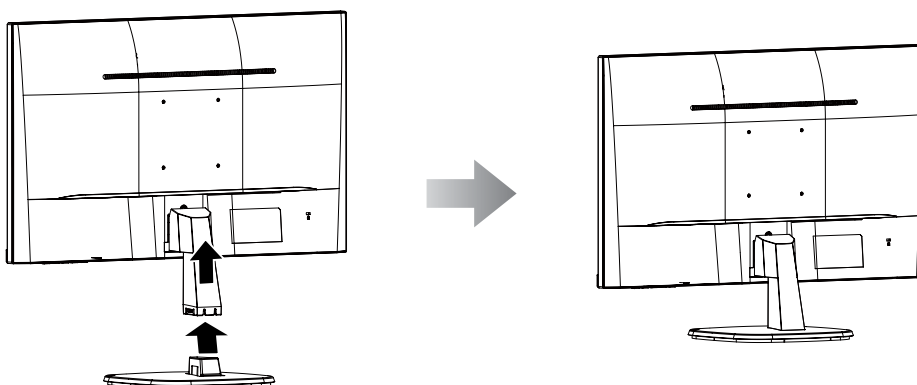

LA-27

PRODUCT DESCRIPTION

1.2.2 Adjusting the Tilt

For comfort viewing, tilt the LCD display up to an angle of 15°/20°. Hold the stand with one hand and use the other to adjust the LCD display to the desired angle.

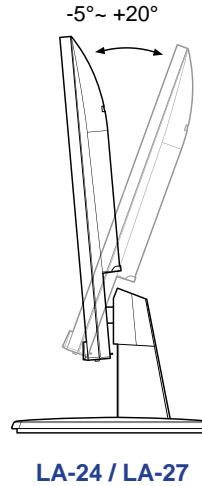
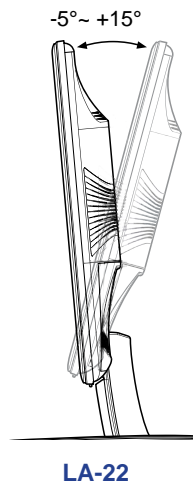

1.2.3 Wall Mounting

To wall mount the LCD display, do the following steps:

1. Remove the base stand.

Please refer to page 28.

2. Remove the base mount.

- a. Place the LCD display with the screen side down on a cushioned surface.
- b1. Remove the screws securing the base mount to the LCD display. (LA-22 model)
- b2. Push the release button and detach the stand from the base mount. (LA-24, LA-27 model)
- c. Pull and detach the base mount away from its compartment. (LA-22 model)

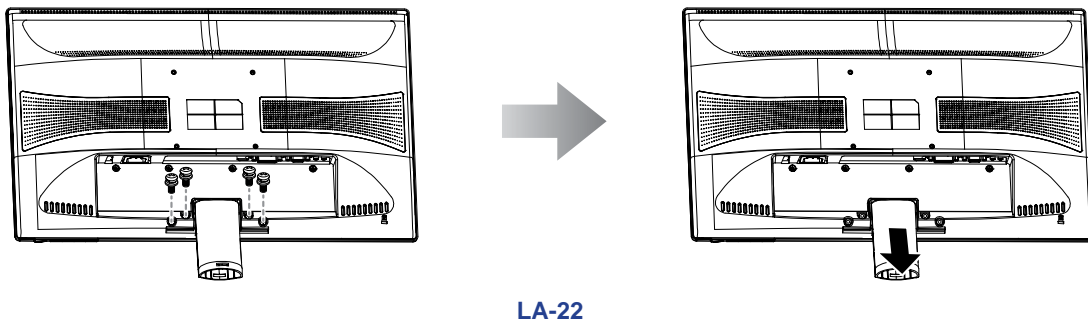

PRODUCT DESCRIPTION

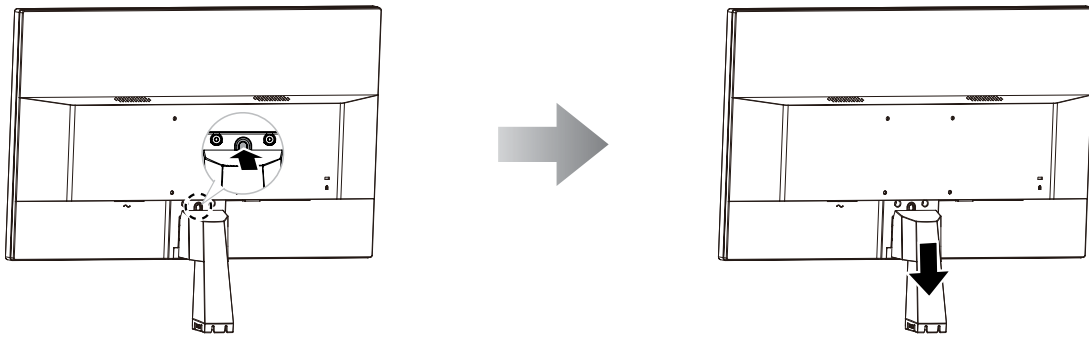

LA-24 / LA-27

3. Wall mount the LCD display.

Screw the mounting bracket to the VESA holes at the rear of the LCD display.

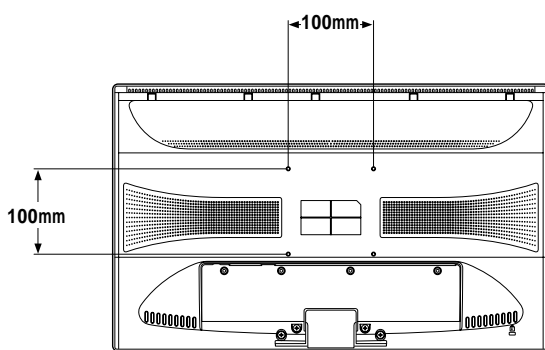

LA-22

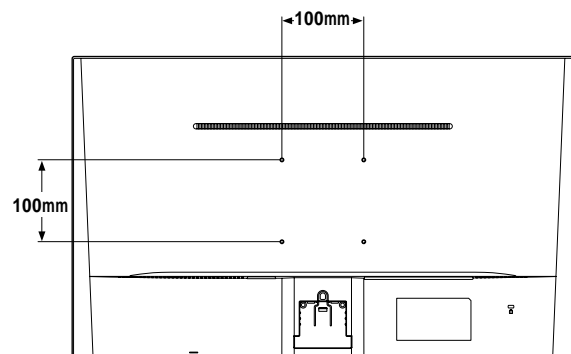

LA-24 / LA-27

Note: Take measures to prevent the LCD display from falling down and lessen possible injury and damage to the display in case of earthquakes or other disasters.

- Use only the 100 x 100 mm wall mount kit recommended by AG Neovo. All AG Neovo wall mount kits comply with VESA standard.
- Secure the LCD display on a solid wall strong enough to bear its weight.
- It is suggested to wall mount the LCD display without tilting it facing downward.

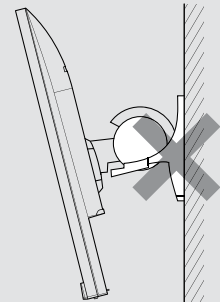

PRODUCT DESCRIPTION

1.3 Overview

1.3.1 Front View

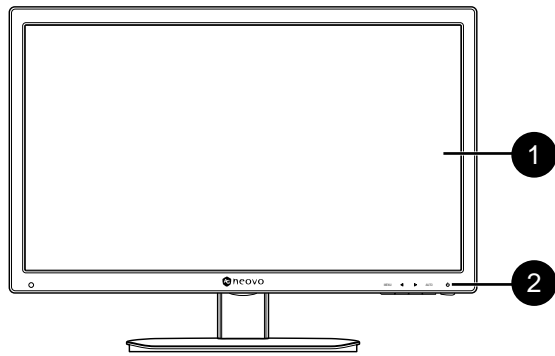

LA-22

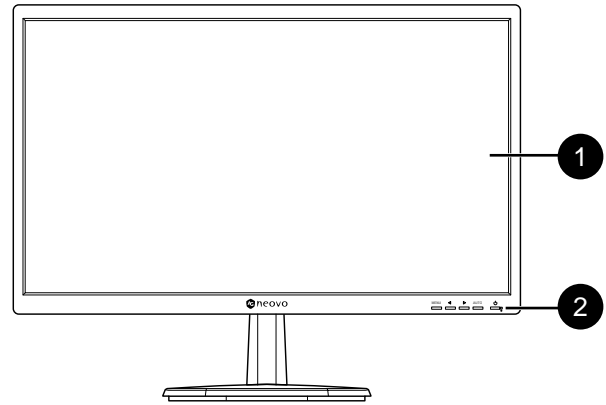

LA-24

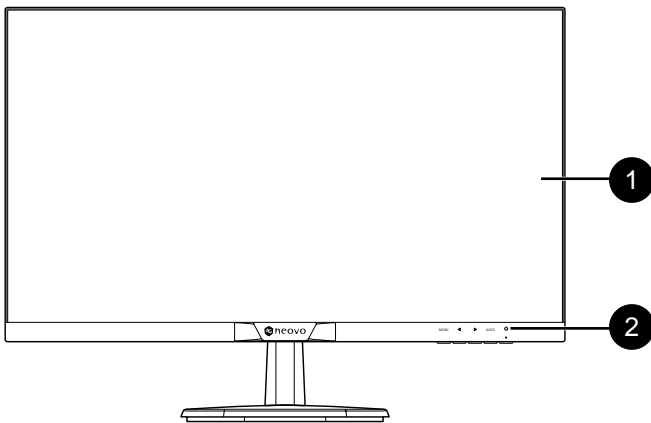

LA-27

1 Display screen

2 Control buttons

Press the button to perform its function. For more information about each button, refer to pages 12-13.

PRODUCT DESCRIPTION

1.3.2 Control Buttons

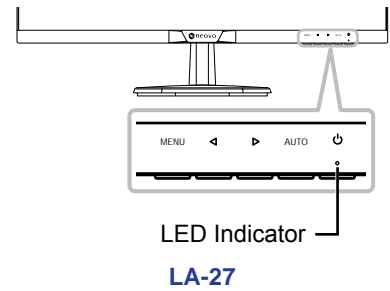
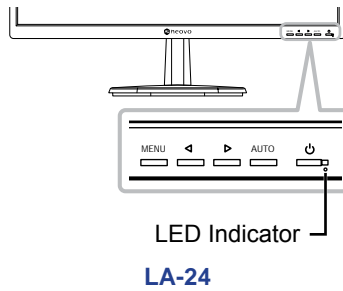
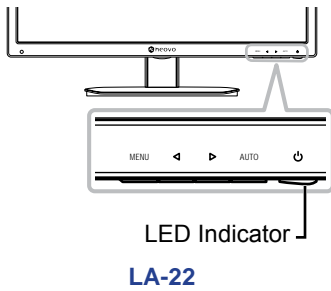

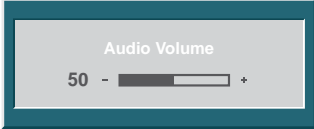
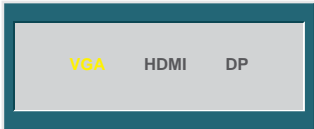
Button	Description
Menu Button (MENU)	<p>On Screen Display (OSD)</p> <ul style="list-style-type: none"> Press to call out the OSD menu. <p>During OSD menu</p> <ul style="list-style-type: none"> Use to confirm the selection or enter a submenu.
Left / Right Button (◀/▶)	<p>Volume Bar</p> <ul style="list-style-type: none"> Press the ▶ button to call out the volume bar.  <p>Then press the ◀/▶ button to adjust the volume level.</p> <p>Note: During volume or menu setting adjustment, press and hold the ◀/▶ button to change the values continuously.</p> <p>Input Select Bar</p> <ul style="list-style-type: none"> Press the ◀ button to call out the Input Select bar.  <p>Then press the ◀/▶ button to switch the input source and press the MENU button to confirm.</p> <p>During OSD menu</p> <ul style="list-style-type: none"> Use to scroll through the menu options. Use to select an option and adjust the settings.

PRODUCT DESCRIPTION

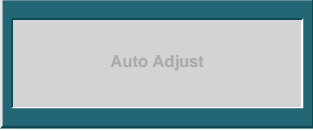
Button	Description
Auto Button (AUTO)	<p>Auto Adjustment (available in VGA input only)</p> <p>Press to perform auto adjustment. This function automatically tunes the LCD display to its optimal setting, including horizontal position, vertical position, clock, and phase.</p> <p>When auto adjustment is initiated, the below message is displayed on the screen.</p> <div data-bbox="791 510 1104 640" style="text-align: center;">  </div> <p>When the message disappears, this indicates the auto adjustment is completed.</p> <p>Note:</p> <ul style="list-style-type: none"> • <i>During auto adjustment, the screen will slightly shake for a few seconds.</i> • <i>It is recommended to use the auto adjustment function when using the LCD display for the first time or after a resolution or frequency change.</i> <p>During OSD menu</p> <ul style="list-style-type: none"> • Use to close the OSD menu or exit a submenu. <p>During volume adjustment</p> <ul style="list-style-type: none"> • Use to close the volume bar.
Power Button (⏻)	<p>Power ON/OFF</p> <ul style="list-style-type: none"> • Press once to turn the display ON. • Press again to turn the display OFF.
LED Indicator	<p>LED lights green during normal operation and blinks green when on standby mode.</p>

PRODUCT DESCRIPTION

1.3.3 Rear View

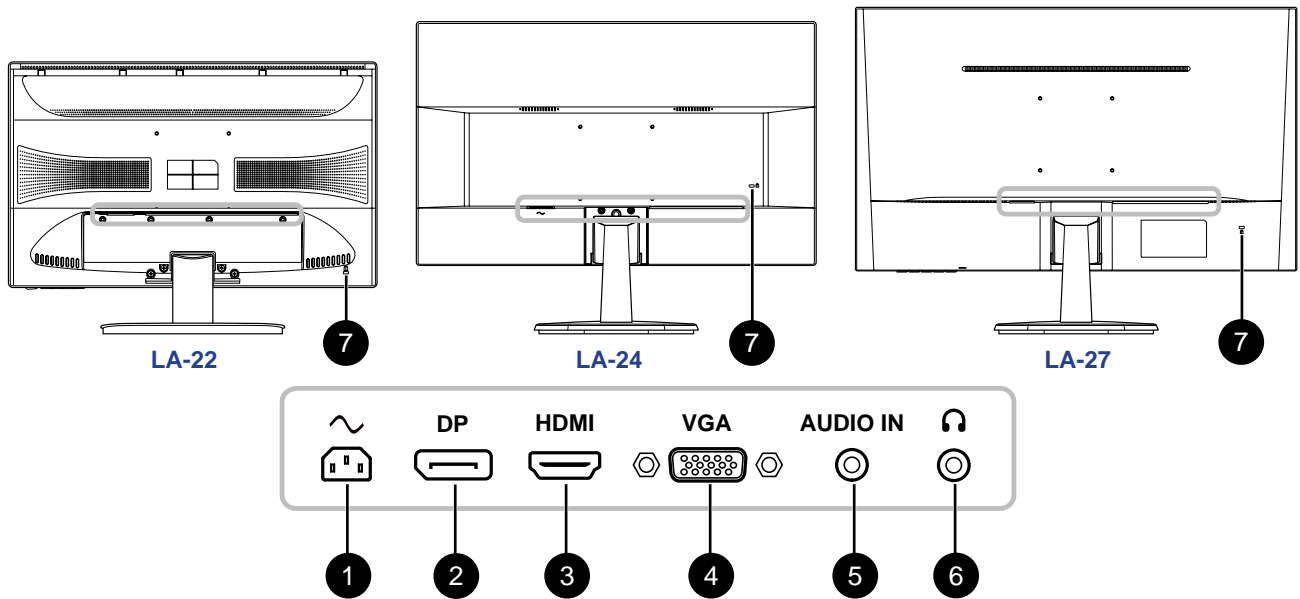

- 1 AC Power Input**
Use to connect the power cord.
- 2 DP (DisplayPort) connector**
Use to connect an DisplayPort cable for digital input signal.
- 3 HDMI connector**
Use to connect an HDMI cable for digital input signal.
- 4 VGA connector**
Use to connect a VGA cable for analogue input signal.
- 5 Audio In port (3.5mm Audio Jack)**
Use to connect an audio cable for audio input.
- 6 Head Phone (3.5mm Audio Jack)**
Use to connect a head phone.
- 7 Kensington lock socket**
Use to physically lock the system to prevent theft.
The locking device is sold separately. To purchase, contact your retailer.

CHAPTER 2: MAKING CONNECTIONS



CAUTION:

Make sure that the LCD display is not connected to the power outlet before making any connections. Connecting cables while the power is ON may cause possible electric shock or personal injury.

2.1 Connecting the AC Power

1. Connect the power cord to the AC power input at the rear of the LCD display.
2. Connect the plug to a power outlet or power supply.

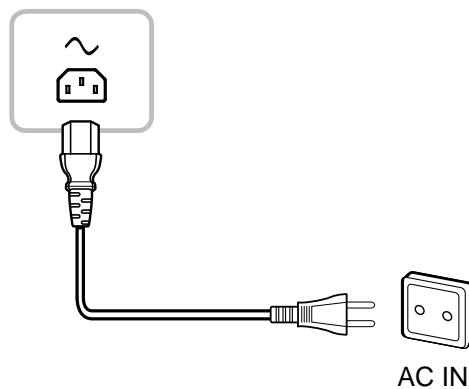

CAUTION:

When unplugging the power cord, hold the power cord by the plug head. Never pull by the cord.

MAKING CONNECTIONS

2.2 Connecting Input Source Signals

Input source signals can be connected with either of the following cables:

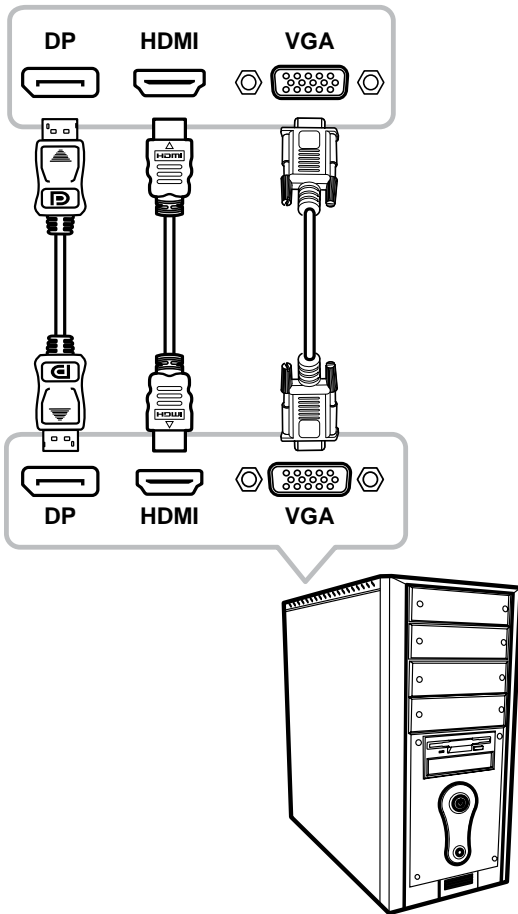

- **DisplayPort**

Connect one end of a DisplayPort cable to the DisplayPort connector of the LCD display and the other end to the DisplayPort connector of the computer.

- **HDMI**

Connect one end of an HDMI cable to the HDMI connector of the LCD display and the other end to the HDMI connector of the computer.

- **VGA**

Connect one end of a D-sub 15-pin cable to the VGA connector of the LCD display and the other end to the D-sub connector of the computer.

MAKING CONNECTIONS

2.3 Connecting Audio Devices

- **Audio Input**

Connect one end of an audio cable to the audio port of the LCD display and the other end to the audio port of the computer.

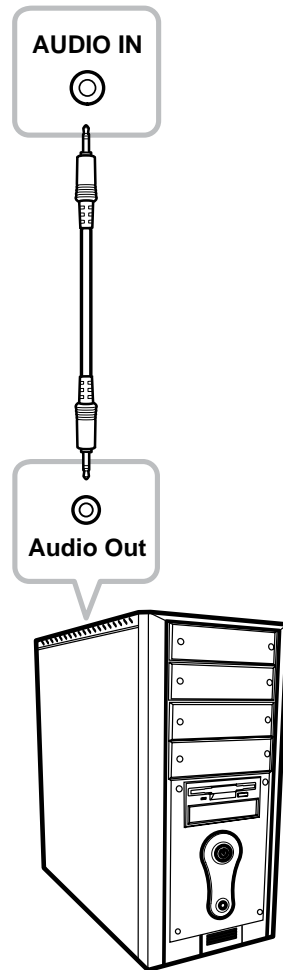

- **Audio Output**

Connect a headphone to the headphone jack of the LCD display.

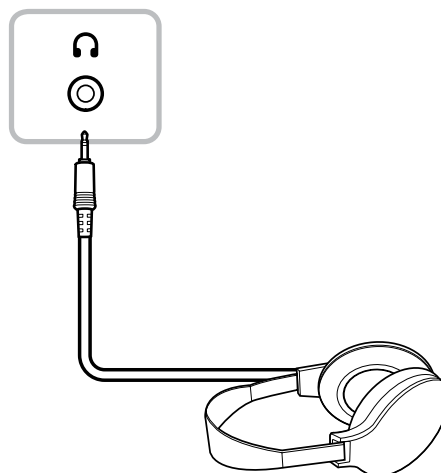

CHAPTER 3: ON SCREEN DISPLAY MENU

3.1 Using the OSD Menu

1. Press the MENU button to call out the OSD window.

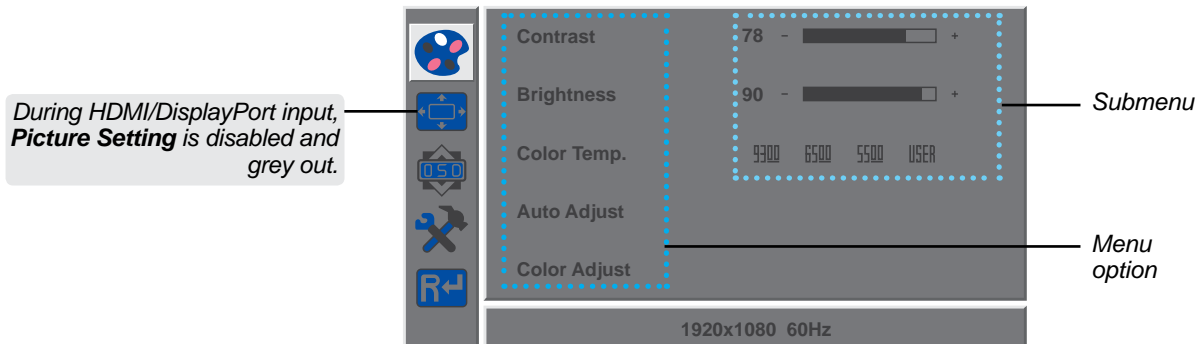

2. Press the ◀ or ▶ button to select a menu and press the MENU button to enter the selected menu.

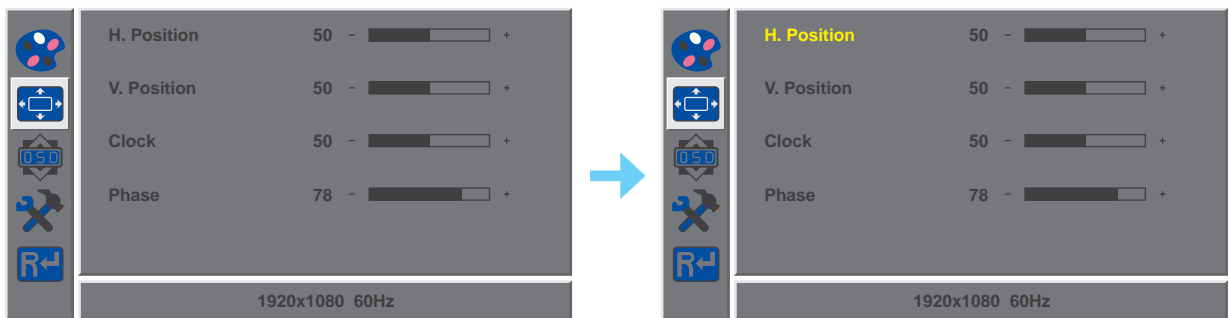

A selected menu is highlighted in grey and the text of the selected menu option turns yellow.

3. Press the ◀ or ▶ button to select an option and press the MENU button to enter its submenu.

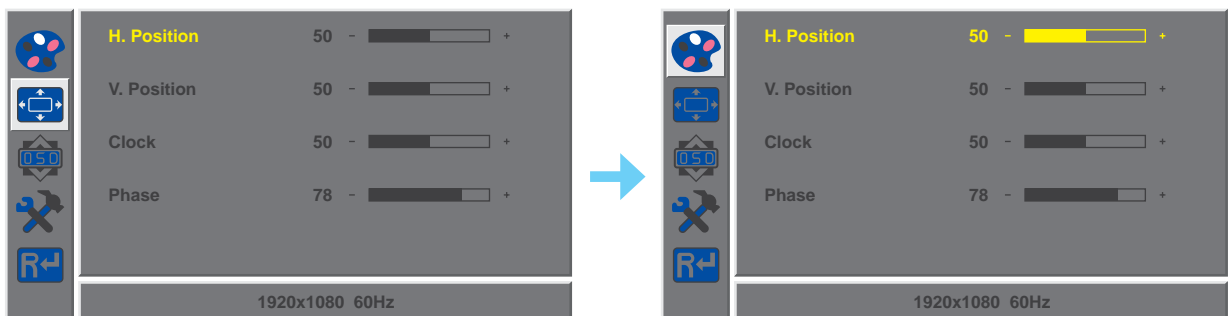

The text of the selected menu option or submenu turns yellow.

4. Press the ◀ or ▶ button to adjust the settings.
5. To exit the submenu, press the AUTO button.
6. To close the OSD window, press the AUTO button twice.

Note: When settings are modified, all changes are saved when the user does the following:

- Proceeds to another menu
- Exits the OSD menu
- Waits for the OSD menu to disappear

ON SCREEN DISPLAY MENU

3.2 OSD Menu Tree

Main Menu	Submenu		Reference	
Colour	Contrast		Refer to page 21.	
	Brightness			
	Color Temp.	9300		
		6500		
		5500		
		USER		
	Auto Adjust			
Color Adjust				
Picture	H. Position		Refer to page 22.	
	V. Position			
	Clock			
	Phase			
OSD	Language	English	Refer to page 23.	
		Français		
		Deutsch		
		Italiano		
		Русский		
		Spanish		
		Portuguese		
		日本語		
		한국어		
		繁體中文		
		简体中文		
	Polski			
	OSD H. Pos.			
	OSD V. Pos.			
	OSD Timer			
Transparency				

ON SCREEN DISPLAY MENU

Main Menu	Submenu		Reference
Other	Mode	PC	
		Vivid	
		Movie	
	Audio Volume		
	Signal Source	VGA	
		HDMI	
		DP	
	Aspect Ratio	16:9	
		AUTO	
		4:3	
	Active Contrast	On	
		Off	
	Over Drive	On	
		Off	
Anti Blue Light			
ANTI-BURN-IN			
Reset	Reset		Refer to page 25.

Note: Availability of some menu items depend on the input source signal. If the menu is not available, it is disabled and greyed out.

CHAPTER 4: ADJUSTING THE LCD DISPLAY

4.1 Colour Setting

1. Press the **MENU** button to call out the OSD window.
2. Press the ◀ or ▶ button to select  and press the **MENU** button to enter the Colour menu.

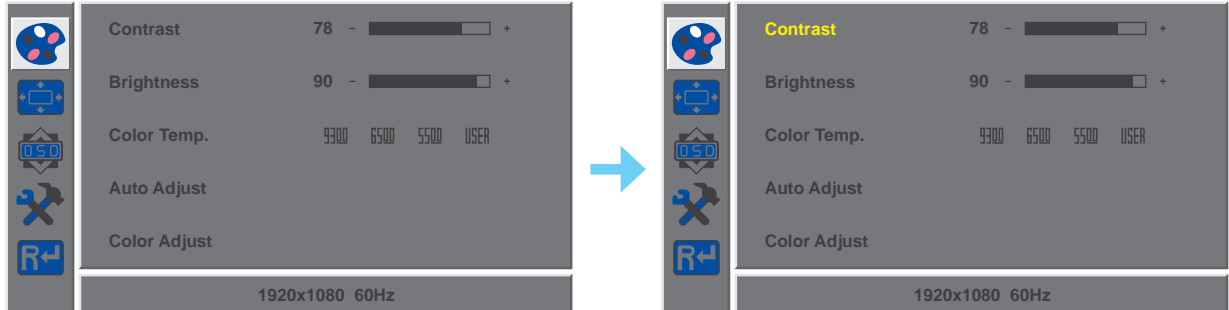

3. Press the ◀ or ▶ button to select an option and press the **MENU** button to enter its submenu.

Item	Function	Operation	Range
Contrast	Adjusts the difference between the black level and the white level.	Press the ◀ or ▶ button to adjust the value.	0 to 100
Brightness	Adjusts the luminance of the screen image.		
Color Temp. (Colour Temperature)	Provides several colour adjustment settings.	Press the ◀ or ▶ button to select the setting.	9300 6500 5500 USER
	Colour temperature can be set to: <ul style="list-style-type: none"> • 9300 - Applies a bluish tint for cooler colours. • 6500 - This is the default colour temperature commonly used for normal lighting conditions. • 5500 - Applies a reddish tint for warmer colours. • USER - This allows users to set the colour temperature by adjusting the red, green, or blue setting according to one's preference. <ol style="list-style-type: none"> a. Select USER and press the MENU button. b. Press the ◀ or ▶ button to select the colour you want to adjust. Then press the MENU button to enter its submenu. c. Press the ◀ or ▶ button to adjust the value (0 ~ 255). <p>Note: Activate Reset to return the colour to its default setting.</p>		
Auto Adjust	Automatically optimises image display.	Press the MENU button to execute the function.	-
Color Adjust	Operates the white balance and automatically adjusts the colour settings.		-

ADJUSTING THE LCD DISPLAY

4.2 Picture Setting

Note: This menu is only available if the input source is VGA.

1. Press the MENU button to call out the OSD window.
2. Press the ◀ or ▶ button to select  and press the MENU button to enter the Picture menu.

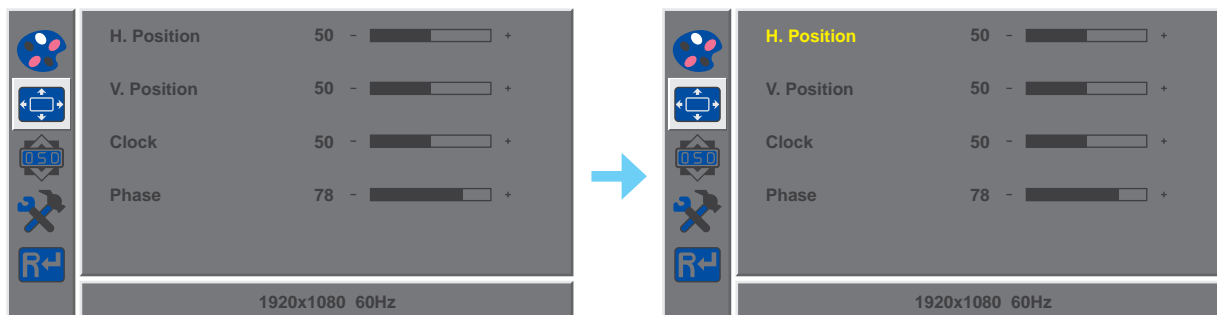

3. Press the ◀ or ▶ button to select an option and press the MENU button to enter its submenu.

Item	Function	Operation	Range
H. Position (Horizontal Position)	Moves the screen image to the left or right.	Press the ◀ or ▶ button to adjust the value.	0 to 100
V. Position (Vertical Position)	Moves the screen image up or down.		
Clock	Adjusts the frequency timing to synchronise with the video signal.		
Phase	Adjusts the phase timing to synchronise with the video signal.		

ADJUSTING THE LCD DISPLAY

4.3 OSD Setting

1. Press the MENU button to call out the OSD window.
2. Press the ◀ or ▶ button to select  and press the MENU button to enter the OSD menu.

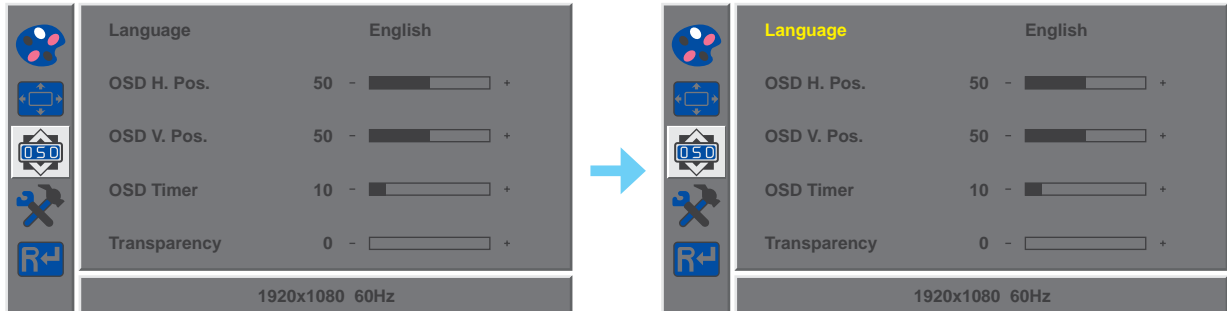

3. Press the ◀ or ▶ button to select an option and press the MENU button to enter its submenu.

Item	Function	Operation	Range
Language	Choose the language used for OSD menus.	Press the ◀ or ▶ button to select the setting.	English Français Deutsch Italiano Русский Spanish Portuguese 日本語 한국어 繁體中文 简体中文 Polski
OSD H. Pos. (Horizontal Position)	Moves the OSD window to the left or right of the screen.	Press the ◀ or ▶ button to adjust the value.	0 to 100
OSD V. Pos. (Vertical Position)	Moves the OSD window up or down the screen.		
OSD Timer	Sets the length of time (in seconds) the OSD screen is displayed. When the time elapses, the OSD screen is automatically inactivated.		5 to 60
Transparency	Adjusts the transparency level of the OSD screen.		0 to 4

ADJUSTING THE LCD DISPLAY

4.4 Other Setting

1. Press the MENU button to call out the OSD window.
2. Press the ◀ or ▶ button to select  and press the MENU button to enter the Other menu.

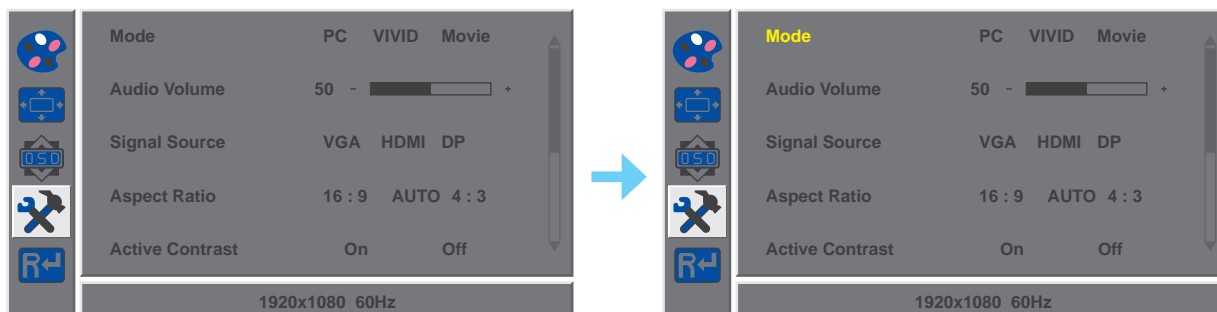

3. Press the ◀ or ▶ button to select an option and press the MENU button to enter its submenu.

Item	Function	Operation	Range
Mode	Selects the display mode.	Press the ◀ or ▶ button to select the setting.	PC VIVID Movie
Audio Volume	Adjusts the volume level of the built-in speaker.	Press the ◀ or ▶ button to adjust the value.	0 to 100
Signal Source	Switches the input source.	Press the ◀ or ▶ button to select the setting.	VGA HDMI DP
Aspect Ratio	Selects the aspect ratio of the screen image.		16:9 AUTO 4:3
Active Contrast	Automatically adjusts the image contrast according to the scene. Note: If this function is On , Colour > Brightness/Contrast are grey out.		On Off
Over Drive	Enhance the monitor response time.		On Off
Anti Blue Light	Enables/Disables the blue light filter function. When enabled, it decreases the amount of blue light displayed on the screen, ensuring users a comfortable viewing experience by reducing eyestrain after long periods of use.		0 to 100
ANTI-BURN-IN	ENABLE Enables or disables Anti-Burn-in™ function.		On Off
	INTERVAL (HOURS) Selects the interval time (hour) between activating the Anti-Burn-in™ function.		4 5 6 8

ADJUSTING THE LCD DISPLAY

4.5 Reset Setting

1. Press the MENU button to call out the OSD window.
2. Press the ◀ or ▶ button to select **R↵** and press the MENU button to enter the Reset menu.

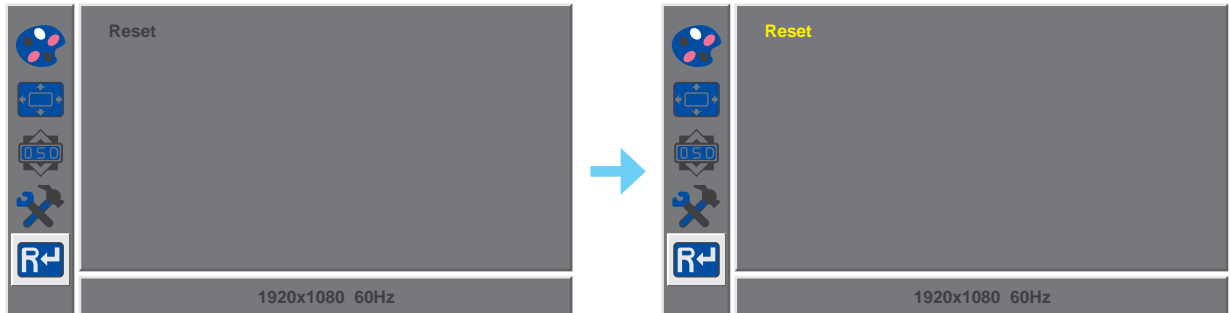



3. Press the MENU button to restore your device to factory settings.

CHAPTER 5: APPENDIX

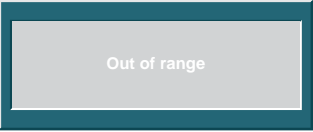

5.1 Warning Messages

When any of these warning messages appear, check the following items.

Warning Message	Cause	Solution
	The resolution or the refresh rate of the graphics card of the computer is set too high.	√ Change the resolution or the refresh rate of the graphics card.
	The LCD display cannot detect the input source signal.	√ Check if the input source is turned ON. √ Check if the signal cable is properly connected. √ Check if any pin inside the cable connector is twisted or broken.

APPENDIX

5.2 Troubleshooting

Problems	Possible Cause and Solution
No picture. <ul style="list-style-type: none"> LED indicator is OFF. 	<ul style="list-style-type: none"> Check if the LCD display is turned ON. Check if the power cord is properly connected to the LCD display. Check if the power cord is plugged into the power outlet.
<ul style="list-style-type: none"> LED indicator is green. 	<ul style="list-style-type: none"> Check if the computer is turned ON. Check if the computer is in standby mode, move the mouse or press any key to wake up the computer.
Image position is incorrect.	<ul style="list-style-type: none"> For VGA input, adjust the H. Position and H. Position settings in Picture  menu (refer to page 22).
The displayed texts are blurry.	<ul style="list-style-type: none"> For VGA input, do the following: <ul style="list-style-type: none"> √ Press the AUTO button to auto-adjust the display (refer to “Auto Button (AUTO)” on page 13). √ Adjust the Clock and Phase settings in Picture  menu (refer to page 22).
Red, blue, green, white dots appear on the screen.	<ul style="list-style-type: none"> There are millions of micro transistors inside the LCD display. It is normal for a few transistors to be damaged and to produce spots. This is acceptable and is not considered a failure.
No audio output.	<ul style="list-style-type: none"> Check if the volume is set to 0 (refer to page 12). In Other  menu, check if the Audio Volume setting is set to 0 (refer to page 24). For VGA input, check the audio setting of the computer.
Dew formed on the LCD display.	<ul style="list-style-type: none"> This normally happens when the LCD display is moved from a cold room to a hot room temperature. Do not turn ON the LCD display, wait for the dew condensation to disappear.
Faint shadows from a static image appear on the screen.	<ul style="list-style-type: none"> Turn off the LCD display for extended periods of time. Use a screen saver or a black and white image and run it for extended periods of time.

APPENDIX

5.3 Transporting the LCD Display

To transport the LCD display for repair or shipment, place the display in its original packaging box.

1. Remove the base stand.

- a. Place the LCD display with the screen side down on a cushioned surface.
- b. Squeeze the notches with 2 fingers on the bottom of base.
- c. Detach the base from the base mount.
- d. Push the release button and detach the stand from the base mount. (LA-24, LA-27 model)

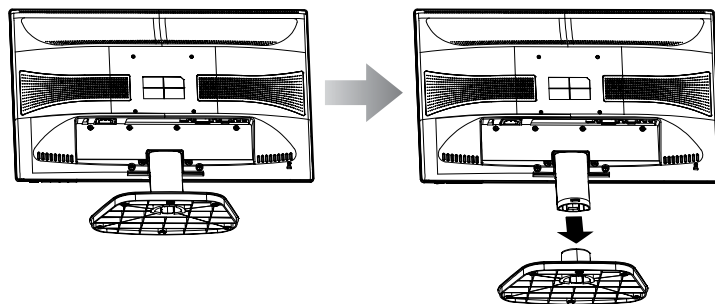

LA-22

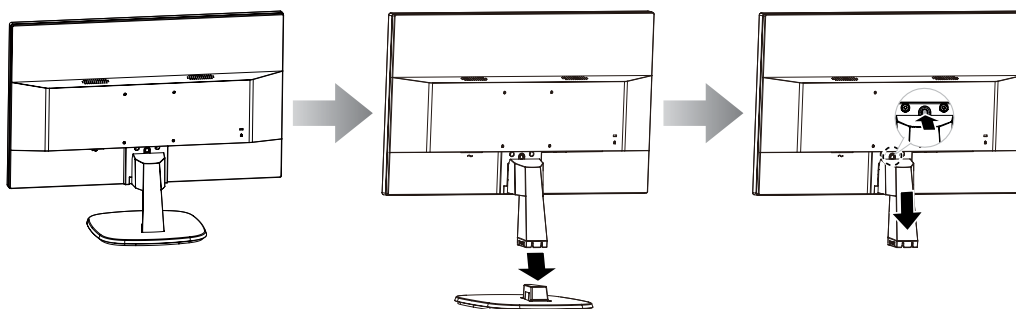

LA-24

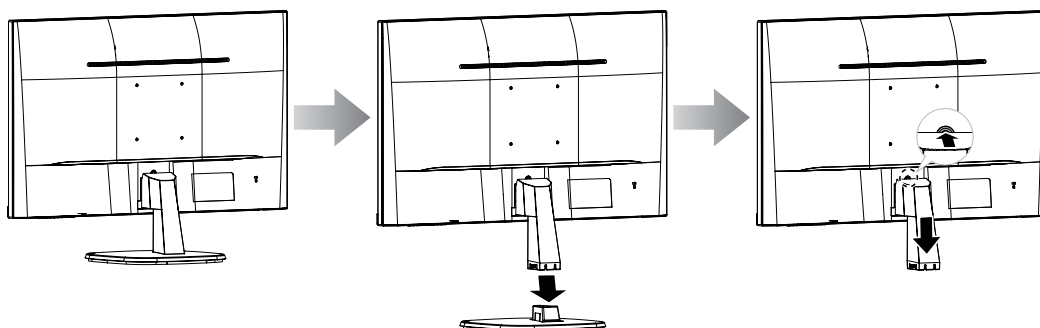

LA-27

2. Put the LCD display inside its original plastic.
3. Place the two foam cushions on each side of the LCD display for protection.
4. Put the LCD display face down in the box.

APPENDIX

5. Put the base face down on the designated vent on top of the foam cushion.
6. Put all other contents on their designated area (if necessary).
7. Close and tape the box.

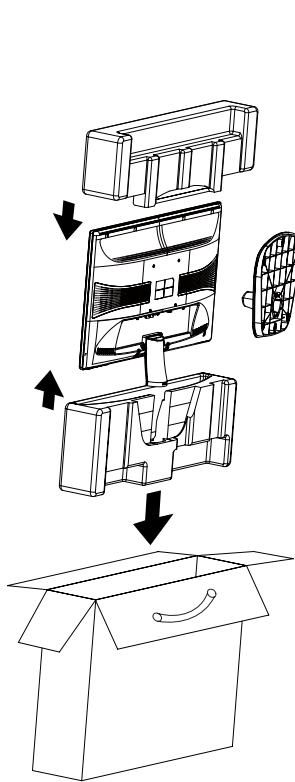

LA-22

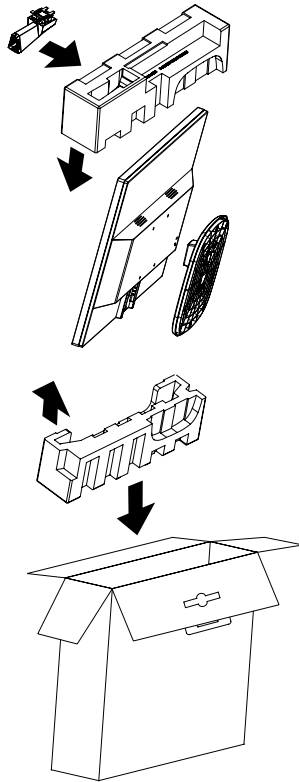

LA-24

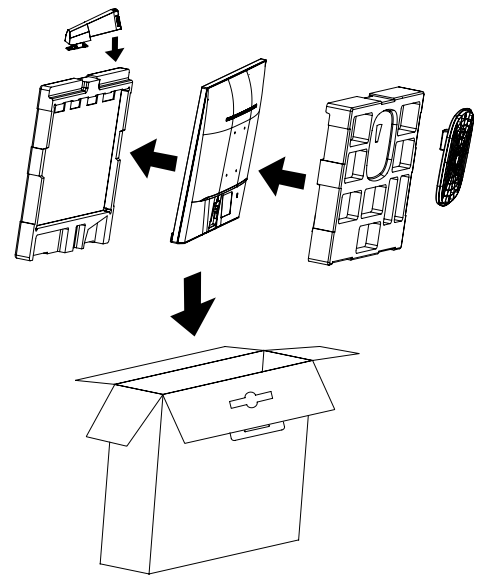

LA-27

Note:

- It is recommended to use the original packaging box.
- When repacking, carefully place the LCD display in its box and protect the glass panel from touching any object.

CHAPTER 6: SPECIFICATIONS

6.1 Display Specifications

		LA-22	LA-24	LA-27
Panel	Panel Type	LED-Backlit TFT LCD (TN Technology)	LED-Backlit TFT LCD (IPS Technology)	LED-Backlit TFT LCD (VA Technology)
	Panel Size	21.5"	23.8"	27.0"
	Max. Resolution	FHD 1920 x 1080	FHD 1920 x 1080	FHD 1920 x 1080
	Pixel Pitch	0.248 mm	0.275 mm	0.314 mm
	Brightness	300 cd/m ²	270 cd/m ²	280 cd/m ²
	Contrast Ratio	20,000,000:1 (DCR)	20,000,000:1 (DCR)	20,000,000:1 (DCR)
	Viewing Angle (H/V)	170°/160°	178°/178°	178°/178°
	Display Colour	16.7M	16.7M	16.7M
	Response Time	3 ms	5 ms	5 ms
Frequency (H/V)	H Freq.	30 kHz-83 kHz	30 kHz-83 kHz	30 kHz-83 kHz
	V Freq.	56 Hz-75 Hz	56 Hz-75 Hz	56 Hz-75 Hz
Input	DisplayPort	x 1	x 1	x 1
	HDMI	1.3 x 1	1.3 x 1	1.3 x 1
	VGA	15-Pin D-Sub x 1	15-Pin D-Sub x 1	15-Pin D-Sub x 1
Audio	Audio In	Stereo Audio Jack (3.5 mm)	Stereo Audio Jack (3.5 mm)	Stereo Audio Jack (3.5 mm)
	Audio Out	Stereo Audio Jack (3.5 mm)	Stereo Audio Jack (3.5 mm)	Stereo Audio Jack (3.5 mm)
	Internal Speaker	2W x 2	2W x 2	2W x 2
Power	Power Supply	Internal	Internal	Internal
	Power Requirements	AC 100-240V, 50/60 Hz	AC 100-240V, 50/60 Hz	AC 100-240V, 50/60 Hz
	On Mode	18W (On)	18W (On)	25W (On)
	Stand-by Mode	< 0.5W	< 0.5W	< 0.5W
	Off Mode	< 0.5W	< 0.5W	< 0.5W
Operating Conditions	Temperature	5°C-35°C (41°F-95°F)	5°C-35°C (41°F-95°F)	5°C-35°C (41°F-95°F)
	Humidity	20%-85% (non-condensing)	20%-85% (non-condensing)	20%-85% (non-condensing)
Storage Conditions	Temperature	-20°C-60°C (-4°F-140°F)	-20°C-60°C (-4°F-140°F)	-20°C-60°C (-4°F-140°F)
	Humidity	5%-85% (non-condensing)	5%-85% (non-condensing)	5%-85% (non-condensing)
Mounting	VESA FPMPMI	Yes (100 x 100 mm)	Yes (100 x 100 mm)	Yes (100 x 100 mm)
Stand	Tilt	-5° to 15°	-5° to 20°	-5° to 20°
Security	Kensington Security Slot	Yes	Yes	Yes
Dimensions	w/ base (W x H x D)	511.0 x 377.0 x 183.0 mm (20.1" x 14.8" x 7.2")	555.0 x 433.0 x 226.0 mm (21.9" x 17.0" x 8.9")	612.0 x 452.0 x 226.0 mm (24.1" x 17.8" x 8.9")
	Packaging (W x H x D)	561.0 x 426.0 x 103.0 mm (22.1" x 16.8" x 4.1")	620.0 x 418.0 x 157.0 mm (24.4" x 16.5" x 6.2")	678.0 x 545.0 x 134 mm (26.7" x 21.5" x 5.3")
Weight	w/ base	3.4 kg (7.5 lb)	3.5 kg (7.7 lb)	4.3 kg (9.5 lb)
	Packaging	4.6 kg (10.1 lb)	5.0 kg (11.0 lb)	5.9 kg (13.0 lb)

Note: All specifications are subject to change without prior notice.

SPECIFICATIONS

6.2 Display Dimensions

LA-22

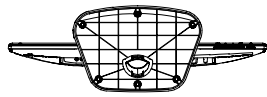
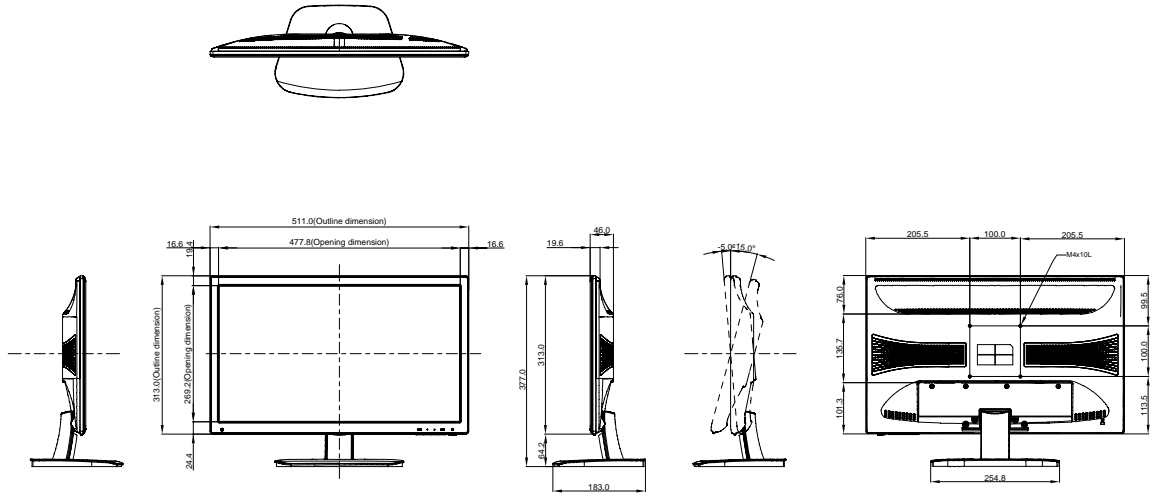

LA-24

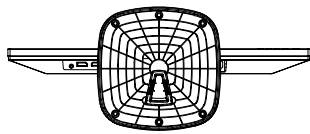
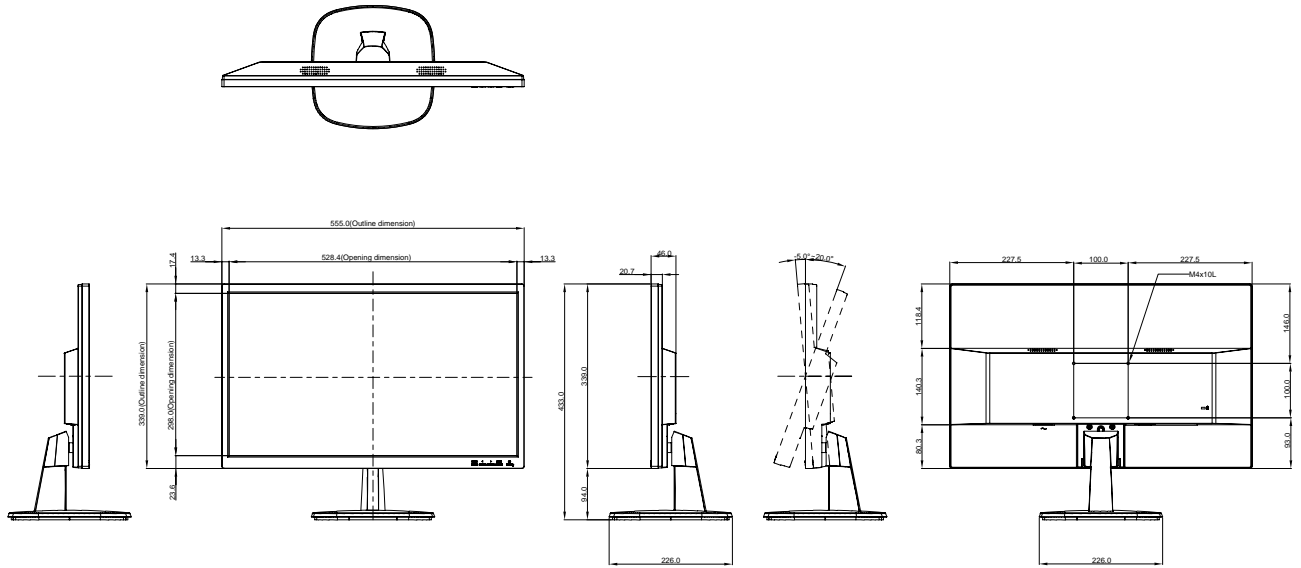

SPECIFICATIONS

LA-27

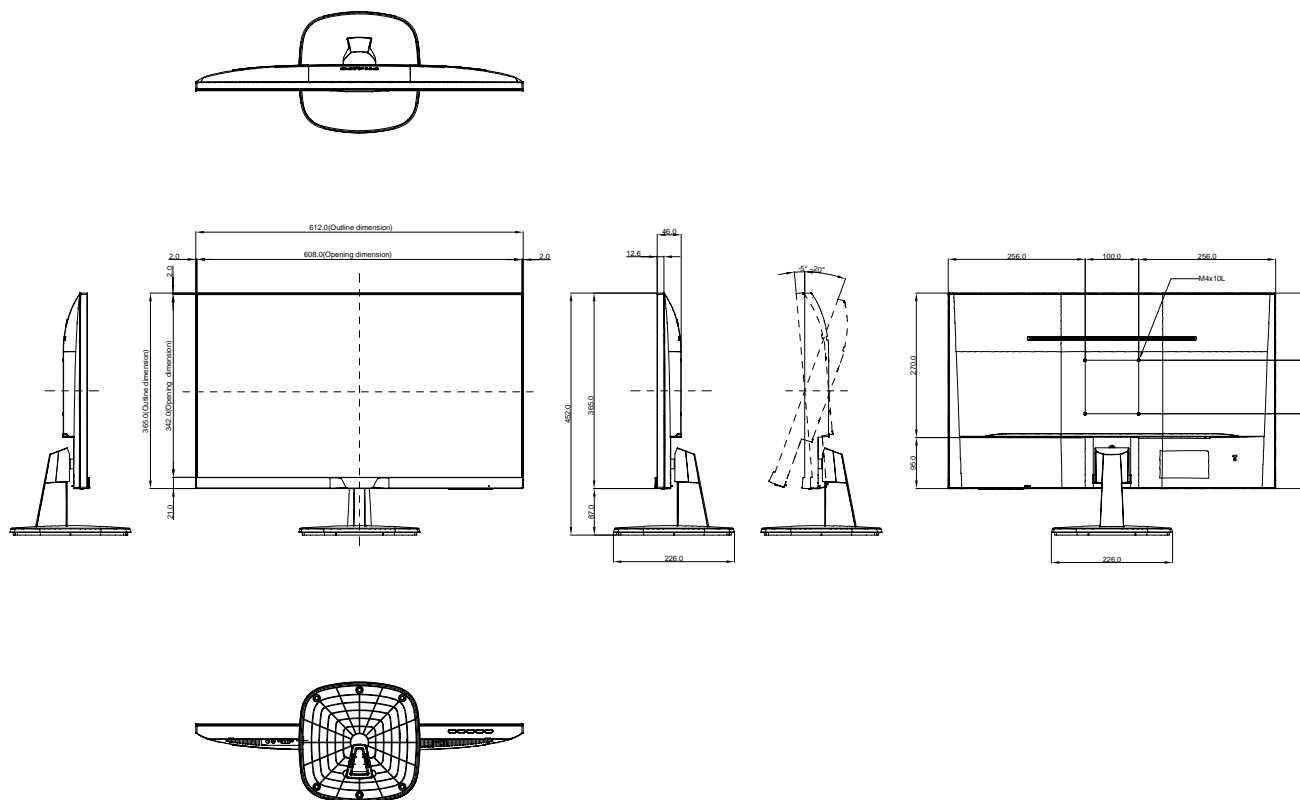

AG Neovo

Company Address: 5F-1, No. 3-1, Park Street, Nangang District, Taipei, 11503, Taiwan.

Copyright © 2020 AG Neovo. All rights reserved.

LA2700/LA2400/LA2200_UM_V012