

# AOC



LCD Monitor  
User Manual

**G2490VX/G2490VXA**  
**G2790VX/G2790VXA**

Safety .....	1
National Conventions .....	1
Power .....	2
Installation .....	3
Cleaning .....	4
Other .....	5
Setup .....	6
Contents in Box .....	6
Setup Stand & Base .....	7
Adjusting Viewing Angle .....	8
Connecting the Monitor .....	9
Wall Mounting .....	10
Adaptive-Sync function .....	11
Adjusting .....	12
Hotkeys .....	12
OSD Setting .....	13
Luminance .....	14
Color Setup .....	15
Picture Boost .....	16
OSD Setup .....	17
Game Setting .....	18
Extra .....	19
Exit .....	20
LED Indicator .....	20
Troubleshoot .....	21
Specification .....	22
General Specification .....	22
Preset Display Modes .....	24
Pin Assignments .....	25
Plug and Play .....	26

# Safety

## National Conventions

The following subsections describe notational conventions used in this document.

### Notes, Cautions, and Warnings

Throughout this guide, blocks of text may be accompanied by an icon and printed in bold type or in italic type. These blocks are notes, cautions, and warnings, and they are used as follows:



**NOTE:** A NOTE indicates important information that helps you make better use of your computer system.



**CAUTION:** A CAUTION indicates either potential damage to hardware or loss of data and tells you how to avoid the problem.



**WARNING:** A WARNING indicates the potential for bodily harm and tells you how to avoid the problem. Some warnings may appear in alternate formats and may be unaccompanied by an icon. In such cases, the specific presentation of the warning is mandated by regulatory authority.

# Power

 The monitor should be operated only from the type of power source indicated on the label. If you are not sure of the type of power supplied to your home, consult your dealer or local power company.

 The monitor is equipped with a three-pronged grounded plug, a plug with a third (grounding) pin. This plug will fit only into a grounded power outlet as a safety feature. If your outlet does not accommodate the three-wire plug, have an electrician install the correct outlet, or use an adapter to ground the appliance safely. Do not defeat the safety purpose of the grounded plug.

 Unplug the unit during a lightning storm or when it will not be used for long periods of time. This will protect the monitor from damage due to power surges.

 Do not overload power strips and extension cords. Overloading can result in fire or electric shock.

 To ensure satisfactory operation, use the monitor only with UL listed computers which have appropriate configured receptacles marked between 100-240V AC, Min. 5A.

 The wall socket shall be installed near the equipment and shall be easily accessible.

# Installation

**!** Do not place the monitor on an unstable cart, stand, tripod, bracket, or table. If the monitor falls, it can injure a person and cause serious damage to this product. Use only a cart, stand, tripod, bracket, or table recommended by the manufacturer or sold with this product. Follow the manufacturer's instructions when installing the product and use mounting accessories recommended by the manufacturer. A product and cart combination should be moved with care.

**!** Never push any object into the slot on the monitor cabinet. It could damage circuit parts causing a fire or electric shock. Never spill liquids on the monitor.

**!** Do not place the front of the product on the floor.

**!** If you mount the monitor on a wall or shelf, use a mounting kit approved by the manufacturer and follow the kit instructions.

**!** Leave some space around the monitor as shown below. Otherwise, air-circulation may be inadequate hence overheating may cause a fire or damage to the monitor.

See below the recommended ventilation areas around the monitor when the monitor is installed on the wall or on the stand:

## Installed with stand



## Cleaning

⚠ Clean the cabinet regularly with cloth. You can use soft-detergent to wipe out the stain, instead of strong-detergent which will cauterize the product cabinet.

⚠ When cleaning, make sure no detergent is leaked into the product. The cleaning cloth should not be too rough as it will scratch the screen surface.

⚠ Please disconnect the power cord before cleaning the product.



## Other

 If the product is emitting a strange smell, sound or smoke, disconnect the power plug IMMEDIATELY and contact a Service Center.

 Make sure that the ventilating openings are not blocked by a table or curtain.

 Do not engage the LCD monitor in severe vibration or high impact conditions during operation.

 Do not knock or drop the monitor during operation or transportation.

# Setup

## Contents in Box

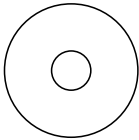
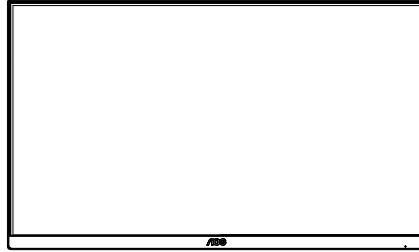

CD Manual

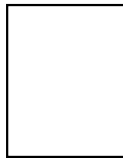

Warranty Card

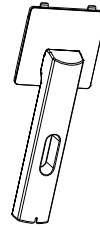

Stand

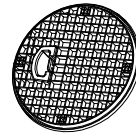

Base



Power Cable



DP Cable



HDMI Cable



Audio Cable

\* Not all signal cables will be provided for all countries and regions. Please check with the local dealer or AOC branch office for confirmation.



# Setup Stand & Base

Please setup or remove the base following the steps as below.

## Setup:

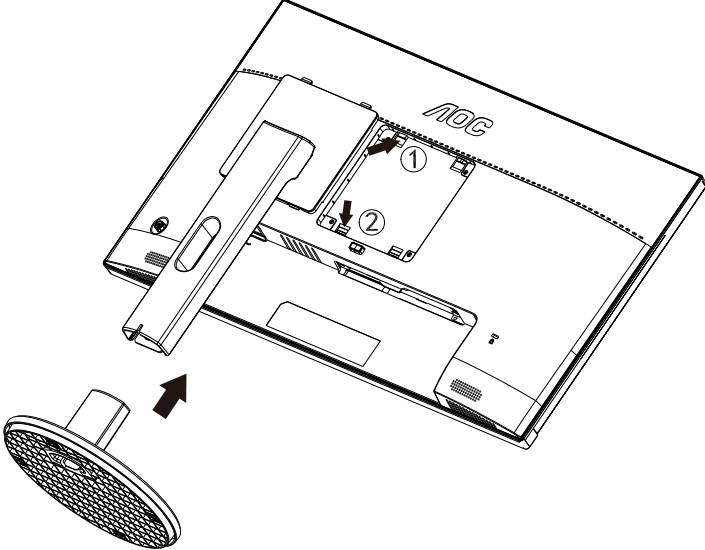

## Remove:

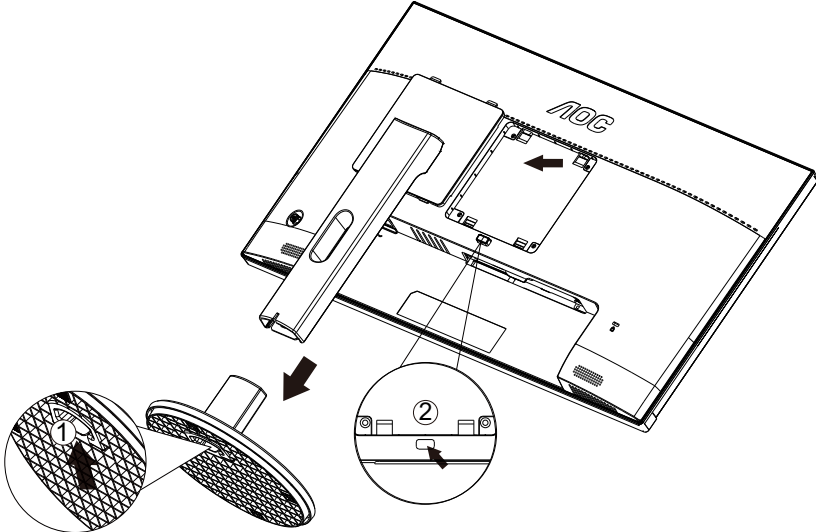

## Adjusting Viewing Angle

For optimal viewing it is recommended to look at the full face of the monitor, then adjust the monitor's angle to your own preference.

Hold the stand so you will not topple the monitor when you change the monitor's angle.

You are able to adjust the monitor as below:

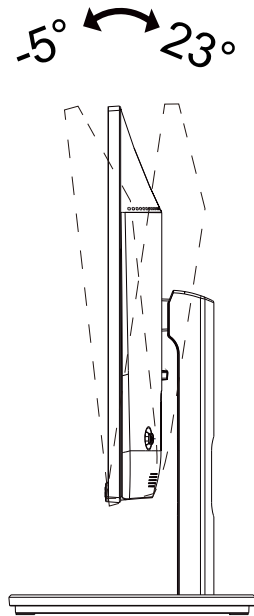

 **NOTE:**

Do not touch the LCD screen when you change the angle. It may cause damage or break the LCD screen.

# Connecting the Monitor

Cable Connections In Back of Monitor and Computer:

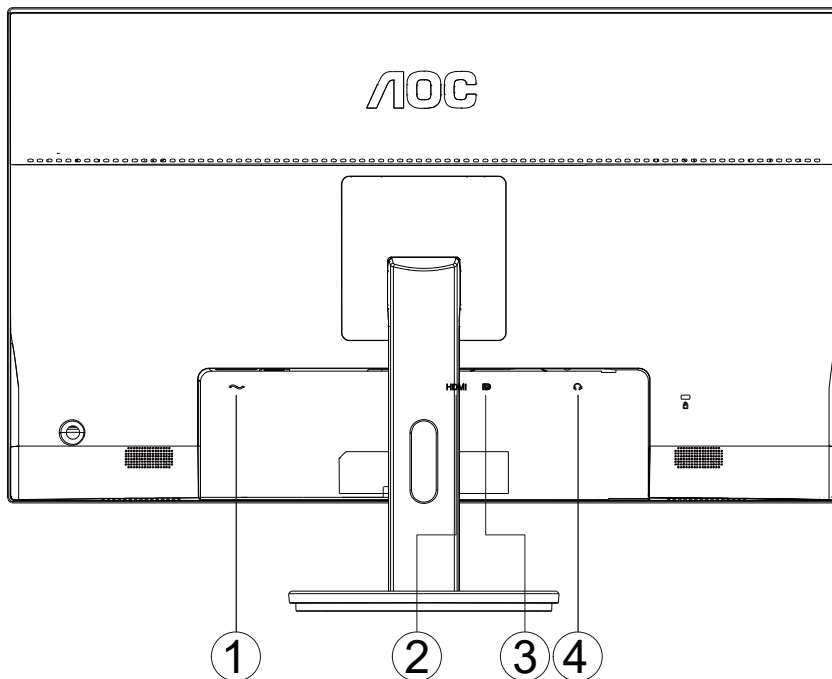

1. Power
2. HDMI
3. DP
4. Earphone

## Connect to PC

1. Connect the power cord to the back of the display firmly.
2. Turn off your computer and unplug its power cable.
3. Connect the display signal cable to the video connector on the back of your computer.
4. Plug the power cord of your computer and your display into a nearby outlet.
5. Turn on your computer and display.

If your monitor displays an image, installation is complete. If it does not display an image, please refer Troubleshooting.

To protect equipment, always turn off the PC and LCD monitor before connecting.

# Wall Mounting

Preparing to Install An Optional Wall Mounting Arm.

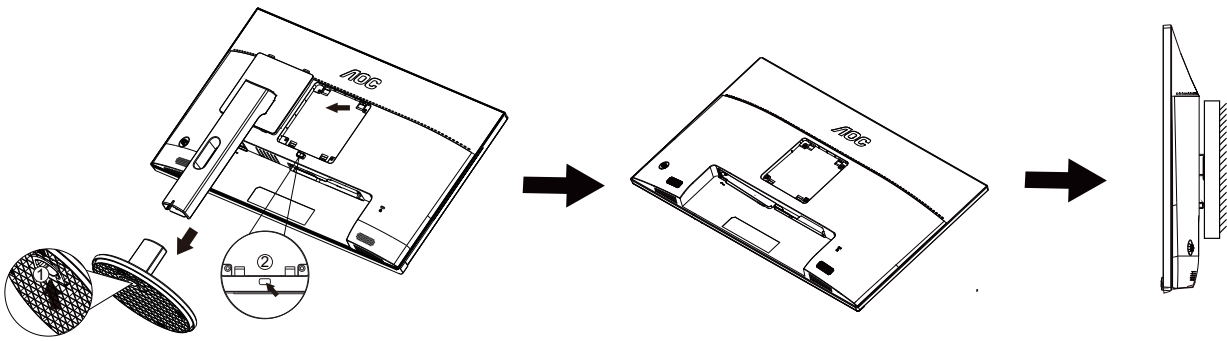

This monitor can be attached to a wall mounting arm you purchase separately. Disconnect power before this procedure. Follow these steps:

1. Remove the base.
2. Follow the manufacturer's instructions to assemble the wall mounting arm.
3. Place the wall mounting arm onto the back of the monitor. Line up the holes of the arm with the holes in the back of the monitor.
4. Reconnect the cables. Refer to the user's manual that came with the optional wall mounting arm for instructions on attaching it to the wall.

Noted: VESA mounting screw holes are not available for all models, please check with the dealer or official department of AOC.

For use only with UL Listed Wall Mount Bracket

Used wall mounting kit: 100 x 100 mm distance, diameter of Screw dimension: M4

## Adaptive-Sync function

1. Adaptive-Sync function is working with DP/HDMI
2. Compatible Graphics Card: Recommend list is as the below, also could be checked by visiting [www.AMD.com](http://www.AMD.com)
  - Radeon™ RX Vega series
  - Radeon™ RX 500 series
  - Radeon™ RX 400 series
  - Radeon™ R9/R7 300 series (R9 370/X, R7 370/X, R7 265 except)
  - Radeon™ Pro Duo (2016)
  - Radeon™ R9 Nano series
  - Radeon™ R9 Fury series
  - Radeon™ R9/R7 200 series (R9 270/X, R9 280/X except)

# Adjusting

## Hotkeys

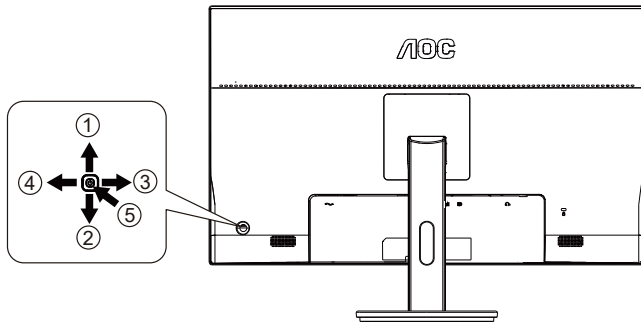

1	Source/Exit
2	Dial Point
3	Game Mode
4	Image Ratio
5	Power/Menu/Enter

### Power/Menu/Enter

Press the Power button to turn on the monitor.  
When there is no OSD, Press to display the OSD or confirm the selection.

### Dial Point

When there is no OSD, press Dial Point button to show / hide Dial Point.

### Image ratio

When there is no OSD, Press > hotkey to active image ratio , Press < or > to adjust 4:3 or wide.

### Game Mode

When there is no OSD, press "Left" key to open game mode function, then press "Left" or "Right" key to select game mode (FPS, RTS, Racing, Gamer 1, Gamer 2 or Gamer 3) basing on the different game types.

### Source/Exit

When the OSD is closed, press Source/Exit button will be Source hot key function.

# OSD Setting

Basic and simple instruction on the control keys.

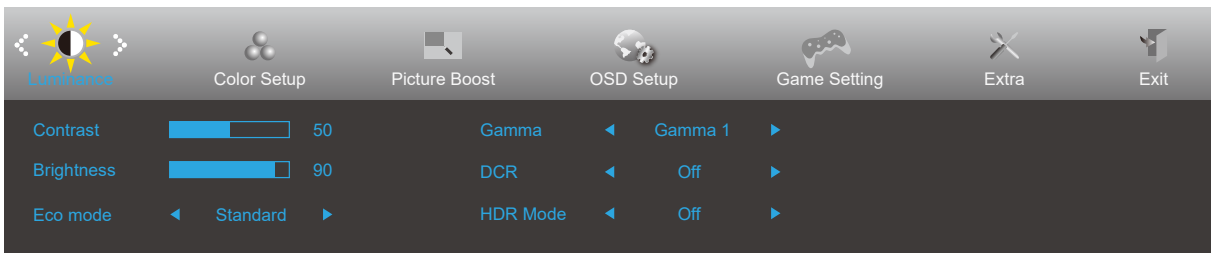







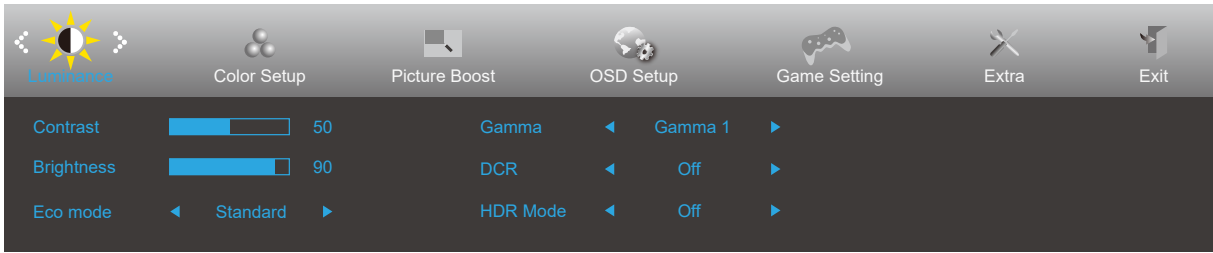

- 1). Press the **MENU-button** to activate the OSD window.
- 2). Press **Left** or **Right** to navigate through the functions. Once the desired function is highlighted, press the **MENU-button** to activate it, press **Left** or **Right** to navigate through the sub-menu functions. Once the desired function is highlighted, press **MENU-button** to activate it.
- 3). Press **Left** or **Right** to change the settings of the selected function. Press **AUTO-button** to exit. If you want to adjust any other function, repeat steps 2-3.
- 4). OSD Lock Function: To lock the OSD, press and hold the **MENU-button** while the monitor is off and then press **power button** to turn the monitor on. To un-lock the OSD - press and hold the **MENU-button** while the monitor is off and then press **power button** to turn the monitor on.

## Notes:

- 1). If the product has only one signal input, the item of "Input Select" is disable to adjust.
- 2). DCR, Color Boost and Picture Boost, for these states that only one state can exist

# Luminance



	Contrast	0-100		Contrast from Digital-register.
	Brightness	0-100		Backlight Adjustment
	Eco mode	Standard	<input checked="" type="checkbox"/>	Standard Mode
		Text		Text Mode
		Internet		Internet Mode
		Game		Game Mode
		Movie		Movie Mode
		Sports		Sports Mode
		Reading		Reading Mode
	Gamma	Gamma1		Adjust to Gamma 1
		Gamma2		Adjust to Gamma 2
		Gamma3		Adjust to Gamma 3
	DCR	Off		Disable dynamic contrast ratio
		On		Enable dynamic contrast ratio
	HDR Mode	OFF		Adjust HDR Mode.
HDR Picture				
HDR Movie				
HDR Game				

**Note:**

When "HDR Mode" is set to "non-off", the items "Contrast", "Brightness", "Gamma" cannot be adjusted.



# Color Setup

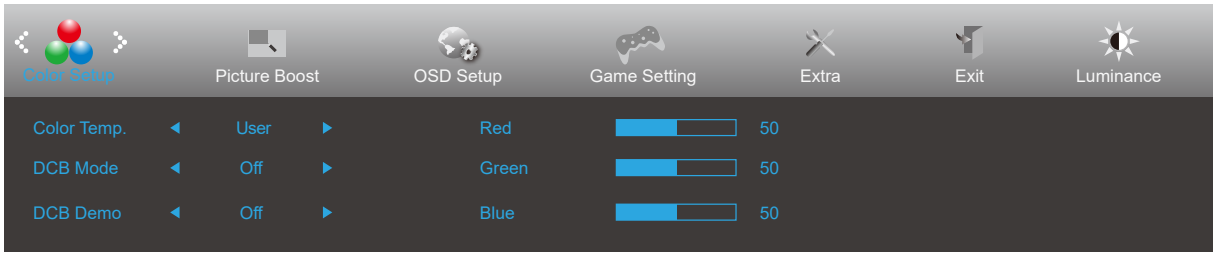



	Color Temp.	Warm		Recall Warm Color Temperature from EEPROM.
		Normal		Recall Normal Color Temperature from EEPROM.
		Cool		Recall Cool Color Temperature from EEPROM.
		sRGB		Recall SRGB Color Temperature from EEPROM.
		User		Restore Color Temperature from EEPROM.
	DCB Mode	Full Enhance	On or Off	Disable or Enable Full Enhance Mode
		Nature Skin	On or Off	Disable or Enable Nature Skin Mode
		Green Field	On or Off	Disable or Enable Green Field Mode
		Sky-blue	On or Off	Disable or Enable Sky-blue Mode
		AutoDetect	On or Off	Disable or Enable AutoDetect Mode
		Off	On or Off	Disable or Enable Off Mode
	DCB Demo		On or Off	Disable or Enable Demo
	Red		0-100	Red gain from Digital-register.
	Green		0-100	Green gain from Digital-register.
Blue		0-100	Blue gain from Digital-register.	

**Note:**

When "HDR Mode" under "Luminance" is set to "non-off", all items under "Color Setup" cannot be adjusted.

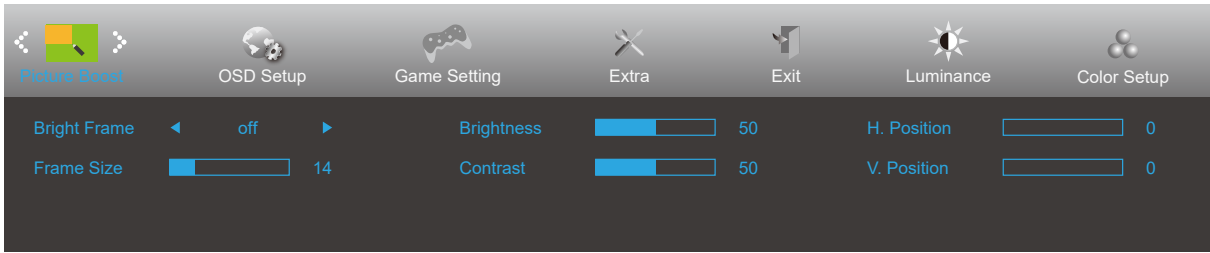
# Picture Boost





	Bright Frame	on or off	Disable or Enable Bright Frame
	Frame Size	14-100	Adjust Frame Size
	Brightness	0-100	Adjust Frame Brightness
	Contrast	0-100	Adjust Frame Contrast
	H. position	0-100	Adjust Frame horizontal Position
	V. position	0-100	Adjust Frame vertical Position

**Note:**

Adjust the brightness, contrast, and position of the Bright Frame for better viewing experience.  
 When “HDR Mode” under “Luminance” is set to “non-off”, all items under “Picture Boost” cannot be adjusted.

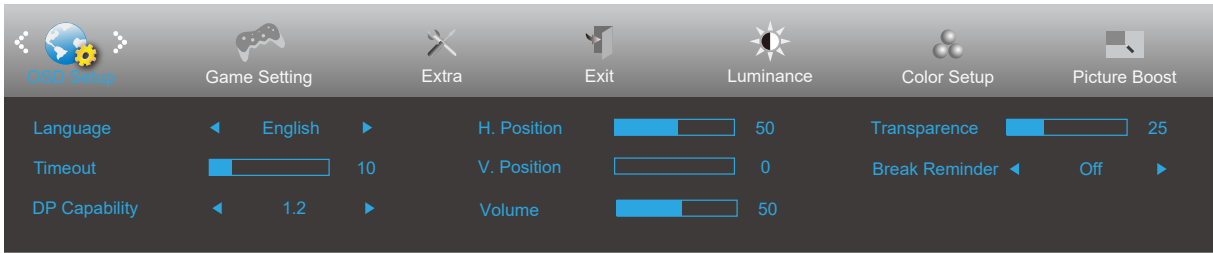
## OSD Setup





	Language		Select the OSD language
	Timeout	5-120	Adjust the OSD Timeout
	DP Capability	1.1/1.2	Please be noted that only DP1.2 support Adaptive-Sync
	H. Position	0-100	Adjust the horizontal position of OSD
	V. Position	0-100	Adjust the vertical position of OSD
	Volume	0-100	Volume Adjustment.
	Transparence	0-100	Adjust the transparence of OSD
	Break Reminder	on or off	Break reminder if the user continuously work for more than 1hrs

**Note:**

If the DP video content supports DP1.2, please select DP1.2 for DP Capability; otherwise, please select DP1.1

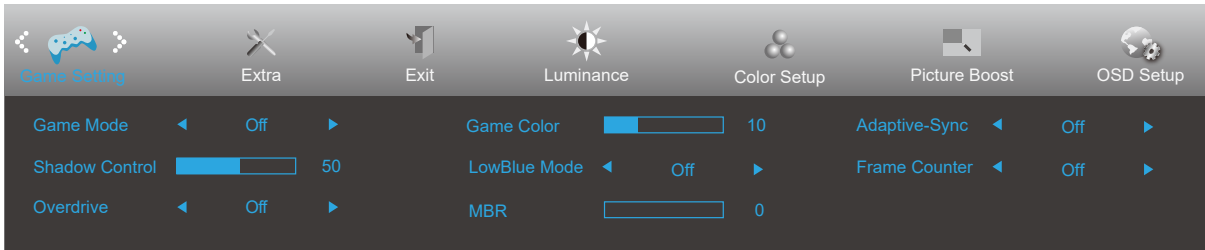
# Game Setting





	Game Mode	FPS	For playing FPS (first Person Shooters) games. Improves dark theme black level details.
		RTS	For playing RTS (Real Time Strategy). Improves the image quality.
		Racing	For playing Racing games, Provides fastest response time and high color saturation.
		Gamer 1	User's preference settings saved as Gamer 1.
		Gamer 2	User's preference settings saved as Gamer 2.
		Gamer 3	User's preference settings saved as Gamer 3.
		OFF	No optimization by Smart image game
	Shadow Control	0-100	Shadow Control Default is 50, then end-user can adjust from 50 to 100 or 0 to increase contrast for clear picture. 1. If picture is too dark to be saw the detail clearly, adjusting from 50 to 100 for clear picture. 2. If picture is too white to be saw the detail clearly, adjusting from 50 to 0 for clear picture
	Overdrive	Weak	Adjust the response time.
		Medium	
Strong			
Boost			
Off			
Game Color	0-20	Game Color will provide 0-20 level for adjusting saturation to get better picture.	
LowBlue Mode	Reading / Office / Internet / Multimedia / Off	Decrease blue light wave by controlling color temperature.	
MBR	0 ~ 20	Adjust the Motion Blur Reduction.	
Adaptive-Sync	On/Off	Adjust the Adaptive-Sync	
Frame Counter	Off / Right-up / Right-Down / Left-Down / Left-Up	Display V frequency on the corner selected	

**Note:**

When "HDR Mode" under "Luminance" is set to "non-off", the items "Game Mode", "Shadow Control", "Game Color", "Low Blue Mode" cannot be adjusted.

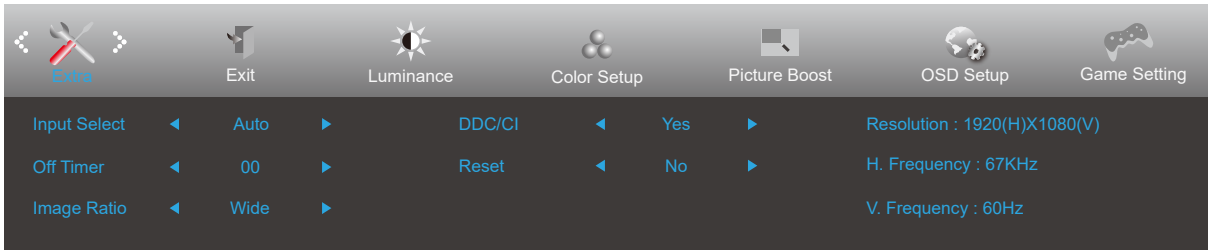
# Extra



	Input Select		Select Input Signal Source
	Off timer	0-24hrs	Select DC off time
	Image Ratio	Wide	Select image ratio for display.
		4:3	
	DDC/CI	yes or no	Turn ON/OFF DDC/CI Support
	Reset	yes or no	Reset the menu to default. (ENERGY STAR® available for selective models.)
ENERGY STAR® or no			

## Exit

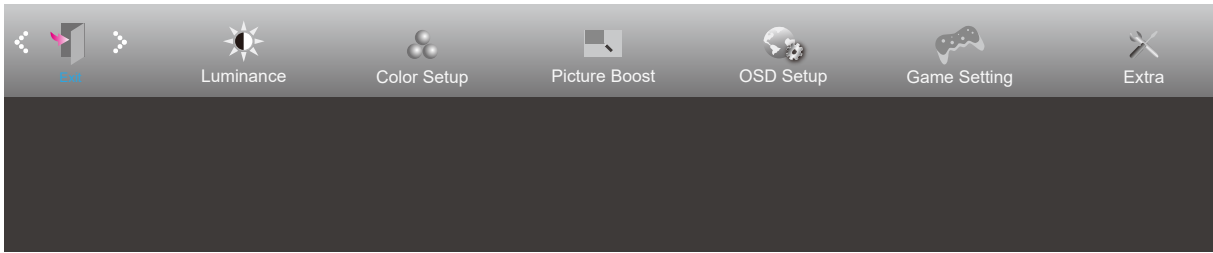

	Exit		Exit the main OSD
---	------	--	-------------------

## LED Indicator

Status	LED Color
Full Power Mode	White
Active-off Mode	Orange

# Troubleshoot

Problem & Question	Possible Solutions
<b>Power LED Is Not ON</b>	Make sure the power button is ON and the Power Cord is properly connected to a grounded power outlet and to the monitor.
<b>No images on the screen</b>	<ul style="list-style-type: none"> <li>● Is the power cord connected properly? Check the power cord connection and power supply.</li> <li>● Is the cable connected correctly? (Connected using the VGA cable) Check the VGA cable connection. (Connected using the HDMI cable) Check the HDMI cable connection. (Connected using the DP cable) Check the DP cable connection. * VGA/HDMI/DP input is not available on every model.</li> <li>● If the power is on, reboot the computer to see the initial screen (the login screen), which can be seen. If the initial screen (the login screen) appears, boot the computer in the applicable mode (the safe mode for Windows 7/8/10) and then change the frequency of the video card. (Refer to the Setting the Optimal Resolution) If the initial screen (the login screen) does not appear, contact the Service Center or your dealer.</li> <li>● Can you see "Input Not Supported" on the screen? You can see this message when the signal from the video card exceeds the maximum resolution and frequency that the monitor can handle properly. Adjust the maximum resolution and frequency that the monitor can handle properly.</li> <li>● Make sure the AOC Monitor Drivers are installed.</li> </ul>
<b>Picture Is Fuzzy &amp; Has Ghosting Shadowing Problem</b>	Adjust the Contrast and Brightness Controls. Press to auto adjust. Make sure you are not using an extension cable or switch box. We recommend plugging the monitor directly to the video card output connector on the back.
<b>Picture Bounces, Flickers Or Wave Pattern Appears In The Picture</b>	Move electrical devices that may cause electrical interference as far away from the monitor as possible. Use the maximum refresh rate your monitor is capable of at the resolution you are using.
<b>Monitor Is Stuck In Active Off-Mode"</b>	The Computer Power Switch should be in the ON position. The Computer Video Card should be snugly fitted in its slot. Make sure the monitor's video cable is properly connected to the computer. Inspect the monitor's video cable and make sure no pin is bent. Make sure your computer is operational by hitting the CAPS LOCK key on the keyboard while observing the CAPS LOCK LED. The LED should either turn ON or OFF after hitting the CAPS LOCK key.
<b>Missing one of the primary colors (RED, GREEN, or BLUE)</b>	Inspect the monitor's video cable and make sure that no pin is damaged. Make sure the monitor's video cable is properly connected to the computer.
<b>Screen image is not centered or sized properly</b>	Adjust H-Position and V-Position or press hot-key (AUTO).
<b>Picture has color defects (white does not look white)</b>	Adjust RGB color or select desired color temperature.
<b>Horizontal or vertical disturbances on the screen</b>	Use Windows 7/8/10 shut-down mode to adjust CLOCK and FOCUS. Press to auto-adjust.
<b>Regulation &amp; Service</b>	Please refer to Regulation & Service Information which is in the CD manual or <a href="http://www.aoc.com">www.aoc.com</a> (to find the model you purchase in your country and to find Regulation & Service Information in Support page.)

# Specification

## General Specification

Panel	Model name	G2490VX/G2490VXA		
	Driving system	TFT Color LCD		
	Viewable Image Size	60.5 cm diagonal		
	Pixel pitch	0.2745mm(H) x 0.2745mm(V)		
	Video	HDMI Interface & DP Interface		
	Separate Sync	H/V TTL		
	Display Color	16.7M Colors		
Others	Horizontal scan range	30k-160kHz		
	Horizontal scan Size(Maximum)	527.04 mm		
	Vertical scan range	48-144Hz		
	Vertical Scan Size(Maximum)	296.46 mm		
	Optimal preset resolution	1920x1080@60Hz		
	Max resolution	1920x1080@144Hz		
	Plug & Play	VESA DDC2B/CI		
	Input Connector	HDMI/DP		
	Input Video Signal	Analog: 0.7Vp-p(standard), 75 OHM, TMDS		
	Output Connector	Earphone out		
	Power Source	100-240V~, 50/60Hz, 1.5A		
	Power Consumption	Typical (Default brightness and contrast)	22W	
		Max. (brightness = 100, contrast =100)	≤ 35W(G2490VX) 42W(G2490VXA)	
Standby mode		≤ 0.5W		
Physical Characteristics	Connector Type	HDMI/DP/Earphone out		
	Signal Cable Type	Detachable		
Environmental	Temperature	Operating	0° ~ 40°	
		Non-Operating	-25° ~ 55°	
	Humidity	Operating	10% ~ 85% (non-condensing)	
		Non-Operating	5% ~ 93% (non-condensing)	
	Altitude	Operating	0~ 5000 m (0~ 16404ft )	
		Non-Operating	0~ 12192m (0~ 40000ft )	



Panel	Model name	G2790VX/G2790VXA		
	Driving system	TFT Color LCD		
	Viewable Image Size	68.6 cm diagonal		
	Pixel pitch	0.3114mm(H) x 0.3114mm(V)		
	Video	HDMI Interface & DP Interface		
	Separate Sync	H/V TTL		
	Display Color	16.7M Colors		
Others	Horizontal scan range	30k-160kHz		
	Horizontal scan Size(Maximum)	597.888 mm		
	Vertical scan range	48-144Hz		
	Vertical Scan Size(Maximum)	336.312 mm		
	Optimal preset resolution	1920x1080@60Hz		
	Max resolution	1920x1080@144Hz		
	Plug & Play	VESA DDC2B/CI		
	Input Connector	HDMI/DP		
	Input Video Signal	Analog: 0.7Vp-p(standard), 75 OHM, TMDS		
	Output Connector	Earphone out		
	Power Source	100-240V~, 50/60Hz, 1.5A		
	Power Consumption	Typical (Default brightness and contrast)	30W	
Max. (brightness = 100, contrast =100)		≤ 40W(G2790VX) ≤ 48W(G2790VXA)		
Power saving		≤ 0.5W		
Physical Characteristics	Connector Type	HDMI/DP/Earphone out		
	Signal Cable Type	Detachable		
Environmental	Temperature	Operating	0°~ 40°	
		Non-Operating	-25°~ 55°	
	Humidity	Operating	10% ~ 85% (non-condensing)	
		Non-Operating	5% ~ 93% (non-condensing)	
	Altitude	Operating	0~ 5000 m (0~ 16404ft )	
		Non-Operating	0~ 12192m (0~ 40000ft )	

## Preset Display Modes

STANDARD	RESOLUTION	HORIZONTAL FREQUENCY(kHz)	VERTICAL FREQUENCY(Hz)
VGA	640x480@60Hz	31.469	59.94
VGA	640x480@67Hz	35	66.667
VGA	640x480@72Hz	37.861	72.809
VGA	640x480@75Hz	37.5	75
VGA	640x480@100Hz	51.08	99.769
VGA	640x480@120Hz	61.91	119.518
DOS MODE	720x400@70Hz	31.469	70.087
DOS MODE	720x480@60Hz	29.855	59.710
SD	720x576@50Hz	31.25	50
SVGA	800x600@56Hz	35.156	56.25
SVGA	800x600@60Hz	37.879	60.317
SVGA	800x600@72Hz	48.077	72.188
SVGA	800x600@75Hz	46.875	75
SVGA	800x600@100Hz	63.684	99.662
SVGA	800x600@120Hz	76.302	119.97
SVGA	832x624@75Hz	49.725	74.551
XGA	1024x768@60Hz	48.363	60.004
XGA	1024x768@70Hz	56.476	70.069
XGA	1024x768@75Hz	60.023	75.029
XGA	1024x768@100Hz	81.577	99.972
XGA	1024x768@120Hz	97.551	119.989
SXGA	1280x1024@60Hz	63.981	60.02
SXGA	1280x1024@75Hz	79.975	75.025
HD	1280x720@50HZ	37.071	49.827
HD	1280x720@60HZ	45	60
Full HD	1920x1080@60Hz	67.5	60
Full HD	1920x1080@100Hz	113.21	99.93
Full HD	1920x1080@120Hz	137.26	119.982
Full HD	1920x1080@144Hz	158.1	144

# Pin Assignments



## 19-Pin Color Display Signal Cable

Pin No.	Signal Name	Pin No.	Signal Name	Pin No.	Signal Name
1.	TMDS Data 2+	9.	TMDS Data 0-	17.	DDC/CEC Ground
2.	TMDS Data 2 Shield	10.	TMDS Clock +	18.	+5V Power
3.	TMDS Data 2-	11.	TMDS Clock Shield	19.	Hot Plug Detect
4.	TMDS Data 1+	12.	TMDS Clock-		
5.	TMDS Data 1Shield	13.	CEC		
6.	TMDS Data 1-	14.	Reserved (N.C. on device)		
7.	TMDS Data 0+	15.	SCL		
8.	TMDS Data 0 Shield	16.	SDA		



## 20-Pin Color Display Signal Cable

Pin No.	Signal Name	Pin No.	Signal Name
1	ML_Lane 3 (n)	11	GND
2	GND	12	ML_Lane 0 (p)
3	ML_Lane 3 (p)	13	CONFIG1
4	ML_Lane 2 (n)	14	CONFIG2
5	GND	15	AUX_CH(p)
6	ML_Lane 2 (p)	16	GND
7	ML_Lane 1 (n)	17	AUX_CH(n)
8	GND	18	Hot Plug Detect
9	ML_Lane 1 (p)	19	Return DP_PWR
10	ML_Lane 0 (n)	20	DP_PWR

# Plug and Play

## Plug & Play DDC2B Feature

This monitor is equipped with VESA DDC2B capabilities according to the VESA DDC STANDARD. It allows the monitor to inform the host system of its identity and, depending on the level of DDC used, communicate additional information about its display capabilities.

The DDC2B is a bi-directional data channel based on the I2C protocol. The host can request EDID information over the DDC2B channel.