



REPUBLIC OF
GAMERS

ROG STRIX

XG27VQ

CURVED GAMING MONITOR

ASUS

Copyright © 2017 ASUSTeK COMPUTER INC. All Rights Reserved.

No part of this manual, including the products and software described in it, may be reproduced, transmitted, transcribed, stored in a retrieval system, or translated into any language in any form or by any means, except documentation kept by the purchaser for backup purposes, without the express written permission of ASUSTeK COMPUTER INC. ("ASUS").

Product warranty or service will not be extended if: (1) the product is repaired, modified or altered, unless such repair, modification or alteration is authorized in writing by ASUS; or (2) the serial number of the product is defaced or missing.

ASUS PROVIDES THIS MANUAL "AS IS" WITHOUT WARRANTY OF ANY KIND, EITHER EXPRESS OR IMPLIED, INCLUDING BUT NOT LIMITED TO THE IMPLIED WARRANTIES OR CONDITIONS OF MERCHANTABILITY OR FITNESS FOR A PARTICULAR PURPOSE. IN NO EVENT SHALL ASUS, ITS DIRECTORS, OFFICERS, EMPLOYEES OR AGENTS BE LIABLE FOR ANY INDIRECT, SPECIAL, INCIDENTAL, OR CONSEQUENTIAL DAMAGES (INCLUDING DAMAGES FOR LOSS OF PROFITS, LOSS OF BUSINESS, LOSS OF USE OR DATA, INTERRUPTION OF BUSINESS AND THE LIKE), EVEN IF ASUS HAS BEEN ADVISED OF THE POSSIBILITY OF SUCH DAMAGES ARISING FROM ANY DEFECT OR ERROR IN THIS MANUAL OR PRODUCT.

SPECIFICATIONS AND INFORMATION CONTAINED IN THIS MANUAL ARE FURNISHED FOR INFORMATIONAL USE ONLY, AND ARE SUBJECT TO CHANGE AT ANY TIME WITHOUT NOTICE, AND SHOULD NOT BE CONSTRUED AS A COMMITMENT BY ASUS. ASUS ASSUMES NO RESPONSIBILITY OR LIABILITY FOR ANY ERRORS OR INACCURACIES THAT MAY APPEAR IN THIS MANUAL, INCLUDING THE PRODUCTS AND SOFTWARE DESCRIBED IN IT.

Products and corporate names appearing in this manual may or may not be registered trademarks or copyrights of their respective companies, and are used only for identification or explanation and to the owners' benefit, without intent to infringe.

Table of Contents

Notices	iv
Safety information.....	v
Care & Cleaning	vii
Takeback Services	viii
1.1 Welcome!.....	1- 1
1.2 Package Contents.....	1- 1
1.3 Assembling the Monitor Arm/Base..	1-2
1.4 Connect Cables.....	1-3
1.4.1 Rear of the LCD Monitor	1-3
1.5 Monitor Introduction.....	1-4
1.5.1 Using the Control Buttons	1-4
1.5.2 GamePlus Function.....	1-5
1.5.3 GameVisual Function.....	1-7
2.1 Detaching the Stand (for VESA Wall Mount)	2- 1
2.2 Adjusting the Monitor	3- 1
3.1 OSD (On-Screen Display) Menu.....	3-2
3.1.1 How to Reconfigure	3-2
3.1.2 OSD Function Introduction.....	3-3
3.2 Specifications.....	3-9
3.3 Troubleshooting (FAQ).....	3- 11
3.4 Supported Timing List.....	3-12

Notices

Federal Communications Commission Statement

This device complies with Part 15 of the FCC Rules. Operation is subject to the following two conditions:

- This device may not cause harmful interference, and
- This device must accept any interference received including interference that may cause undesired operation.

This equipment has been tested and found to comply with the limits for a Class B digital device, pursuant to Part 15 of the FCC Rules. These limits are designed to provide reasonable protection against harmful interference in a residential installation. This equipment generates, uses and can radiate radio frequency energy and, if not installed and used in accordance with manufacturer's instructions, may cause harmful interference to radio communications. However, there is no guarantee that interference will not occur in a particular installation. If this equipment does cause harmful interference to radio or television reception, which can be determined by turning the equipment off and on, the user is encouraged to try to correct the interference by one or more of the following measures:

- Reorient or relocate the receiving antenna.
- Increase the separation between the equipment and receiver.
- Connect the equipment to an outlet on a circuit different from that to which the receiver is connected.
- Consult the dealer or an experienced radio/TV technician for help.

This product implements power management functionality. In case of no signal input after 10 seconds, the product automatically goes to sleep/standby mode.

Canadian Department of Communications Statement

This digital apparatus does not exceed the Class B limits for radio noise emissions from digital apparatus set out in the Radio Interference Regulations of the Canadian Department of Communications.

This class B digital apparatus complies with Canadian ICES-003.

AEEE Yönetmeliğine Uygundur

Regional Notice for India

This product complies with the “India E-Waste (Management) Rules, 2016” and prohibits use of lead, mercury, hexavalent chromium, polybrominated biphenyls (PBBs) and polybrominated diphenyl ethers (PBDEs) in concentrations exceeding 0.1 % by weight in homogenous materials and 0.01% by weight in homogenous materials for cadmium, except for the exemptions listed in Schedule II of the Rule.

Safety information

- Before setting up the monitor, carefully read all the documentation that came with the package.
- To prevent fire or shock hazard, never expose the monitor to rain or moisture.
- Never try to open the monitor cabinet. The dangerous high voltages inside the monitor may result in serious physical injury.
- If the power supply is broken, do not try to fix it by yourself. Contact a qualified service technician or your retailer.
- Before using the product, make sure all cables are correctly connected and the power cables are not damaged. If you detect any damage, contact your dealer immediately.
- Slots and openings on the back or top of the cabinet are provided for ventilation. Do not block these slots. Never place this product near or over a radiator or heat source unless proper ventilation is provided.

- The monitor should be operated only from the type of power source indicated on the label. If you are not sure of the type of power supply to your home, consult your dealer or local power company.
- Use the appropriate power plug which complies with your local power standard.
- Do not overload power strips and extension cords. Overloading can result in fire or electric shock.
- Avoid dust, humidity, and temperature extremes. Do not place the monitor in any area where it may become wet. Place the monitor on a stable surface.
- Unplug the unit during a lightning storm or if it will not be used for a long period of time. This will protect the monitor from damage due to power surges.
- Never push objects or spill liquid of any kind into the slots on the monitor cabinet.
- To ensure satisfactory operation, use the monitor only with UL listed computers which have appropriate configured receptacles marked between 100-240V AC.
- The socket-outlet shall be installed near the equipment and shall be easily accessible.
- If you encounter technical problems with the monitor, contact a qualified service technician or your retailer.
- This product may contain chemicals known to the State of California to cause cancer, and birth defects or other reproductive harm. Wash hands after handling.

Care & Cleaning

- Before you lift or reposition your monitor, it is better to disconnect the cables and power cord. Follow the correct lifting techniques when positioning the monitor. When lifting or carrying the monitor, grasp the edges of the monitor. Do not lift the display by the stand or the cord.
- Cleaning. Turn your monitor off and unplug the power cord. Clean the monitor surface with a lint-free, non-abrasive cloth. Stubborn stains may be removed with a cloth dampened with mild cleaner.
- Avoid using a cleaner containing alcohol or acetone. Use a cleaner intended for use with the LCD. Never spray cleaner directly on the screen, as it may drip inside the monitor and cause an electric shock.

The following symptoms are normal with the monitor:

- The screen may flicker during the initial use due to the nature of the fluorescent light. Turn off the Power Switch and turn it on again to make sure that the flicker disappears.
- You may find slightly uneven brightness on the screen depending on the desktop pattern you use.
- When the same image is displayed for hours, an afterimage of the previous screen may remain after switching the image. The screen will recover slowly or you can turn off the Power Switch for hours.
- When the screen becomes black or flashes, or cannot work anymore, contact your dealer or service center to fix it. Do not repair the screen by yourself!

Conventions used in this guide



WARNING: Information to prevent injury to yourself when trying to complete a task.



CAUTION: Information to prevent damage to the components when trying to complete a task.



IMPORTANT: Information that you **MUST** follow to complete a task.



NOTE: Tips and additional information to aid in completing a task.

Where to find more information

Refer to the following sources for additional information and for product and software updates.

1. **ASUS websites**

The ASUS websites worldwide provide updated information on ASUS hardware and software products. Refer to <http://www.asus.com>

2. **Optional documentation**

Your product package may include optional documentation that may have been added by your dealer. These documents are not part of the standard package.

Takeback Services

ASUS recycling and takeback programs come from our commitment to the highest standards for protecting our environment. We believe in providing solutions for our customers to be able to responsibly recycle our products, batteries and other components as well as the packaging materials.

Please go to <http://csr.asus.com/english/Takeback.htm> for detail recycling information in different region.

1.1 Welcome!

Thank you for purchasing the ASUS® LCD monitor!

The latest widescreen LCD monitor from ASUS provides a crisper, broader, and brighter display, plus a host of features that enhance your viewing experience.

With these features, you can enjoy the convenience and delightful visual experience that the monitor brings to you!

1.2 Package Contents

Check your package for the following items:

- ✓ LCD Monitor
- ✓ Monitor Base
- ✓ Quick Start Guide
- ✓ Warranty Card
- ✓ Support CD
- ✓ 1x Adaptor
- ✓ 1x Power Cord
- ✓ 1x HDMI Cable (optional)
- ✓ 1x DP Cable (optional)
- ✓ LED projection cover and changeable films (optional)
- ✓ Input/Output Ports Cover



-
- If any of the above items is damaged or missing, contact your retailer immediately.
 - Select “ON” when you see the message “LIGHT IN MOTION ON/OFF” appears if you want to turn on the red light on the base. Select “OFF” if you want it to turn off. If you disable this function but later wish to reactivate it, please use the OSD menu to turn it on.
 - If no signal is detected for around 12 minutes, the monitor automatically enters saving mode.
-

1.3 Assembling the Monitor Arm/Base



- While assembling the monitor arm/base, we recommend that you keep the monitor inside its EPS (Expanded Polystyrene) packaging.

1. Align the screw hole on the arm with the bundled screw on the base. Then insert the base into the arm.
2. Fix the base to the arm by fastening the bundled screw.
3. Align the triangle marks on the monitor base and the LED projection cover. Then attach the LED projection cover to the monitor base.
4. Remove the monitor from its EPS packaging.

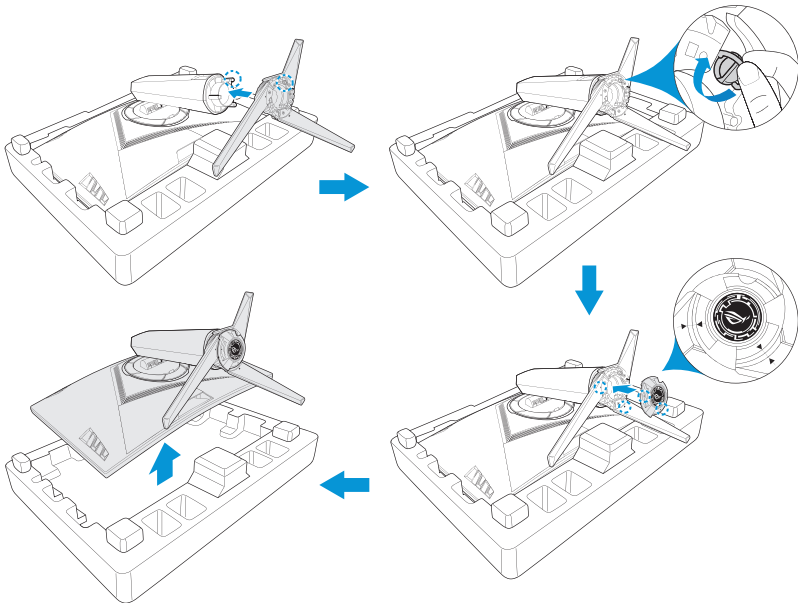

1.4 Connect Cables

1.4.1 Rear of the LCD Monitor

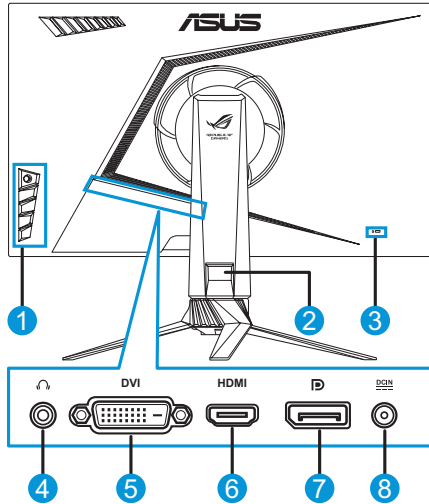

- | | |
|---------------------|----------------|
| 1. Control buttons | 5. DVI port* |
| 2. Cable management | 6. HDMI port |
| 3. Kensington Lock | 7. DisplayPort |
| 4. Earphone jack | 8. DC-IN port |



- *The DVI port supports both DVI-D Single Link cable and DVI-D Dual Link cable:

DVI-D Single Link cable connector

DVI-D Dual Link cable connector

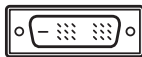





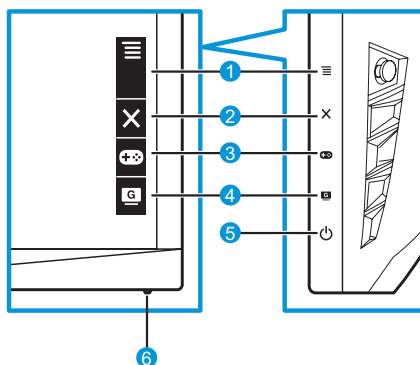

- Only the DVI-D Dual Link cable supports the resolution 1920x1080@144Hz.

1.5 Monitor Introduction

1.5.1 Using the Control Buttons

Use the control buttons on the side of the monitor to adjust the image settings. Press key 1-5 to activate the key list page.



1.  5-way) Button:
 - Turn on the OSD menu. Enact the selected OSD menu item.
 - Increase/Decrease values or moves your selection up/down/left/right.
2.  Close Button:
 - Exit the OSD menu.
 - Turn on the OSD menu when the monitor enters standby mode or display the "NO SIGNAL" message.
3.  GamePlus Button:
 - Activate Crosshair, Timer, FPS Counter, or Display Alignment function.
 - Move the  button up/down to select and press  to confirm the function needed.
 - Turn on the OSD menu when the monitor enters standby mode or display the "NO SIGNAL" message.

4. **G** GameVisual Button:

- Press this hotkey to switch from eight video preset modes (Scenery Mode, Racing Mode, Cinema Mode, RTS/RPG Mode, FPS Mode, sRGB, MOBA Mode, and User Mode) with GameVisual™ Video Intelligence Technology.
- Turn on the OSD menu when the monitor enters standby mode or display the "NO SIGNAL" message.

5. **Power** Power Button:

- Press this button to turn the monitor on/off.

6. Power Indicator:











- The color definition of the power indicator is as the table below.



Status	Description
White	ON
Amber	Standby mode
OFF	OFF

1.5.2 GamePlus Function

The GamePlus function provides a toolkit and creates a better gaming environment for users when playing different types of games. The crosshair overlay with four different crosshair options lets you choose the one that best suits the game you are playing. There is also an onscreen timer you can position on the left of the display so you can keep track of the elapsed gaming time; while the FPS (frames per second) counter lets you know how smooth the game is running. Display Alignment displays alignment lines on 4 sides of the screen, serving as an easy and handy tool for you to line up multiple monitors perfectly.

To active GamePlus:

1. Press the GamePlus hotkey.
2. Move the   button up/down to select among different functions.
3. Press the   button or move the   button right to confirm the function you choose, and move the   button up/down to navigate through the settings. Move the   button left to go back, off, or exit.

4. Highlight the desired setting and press the  () button to activate it. Press the  button to deactivate it.

GamePlus Main Menu

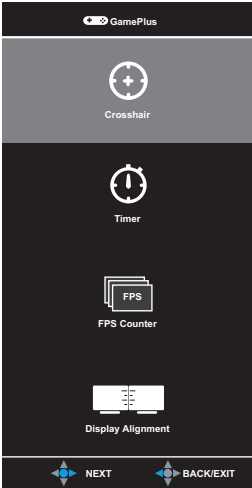

GamePlus – Crosshair

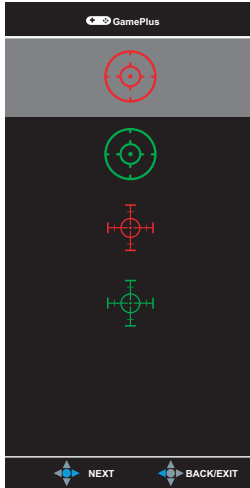

GamePlus – Timer



GamePlus – FPS Counter

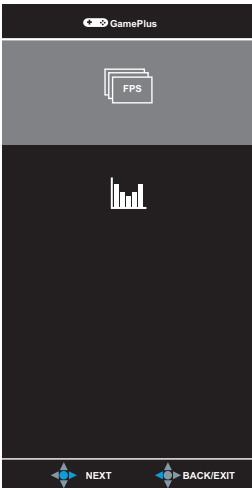

1.5.3 GameVisual Function

The GameVisual function helps you select among different picture modes in a convenient way.

To active GameVisual:

Press the GameVisual hotkey repeatedly to select.

- **Scenery Mode:** This is the best choice for scenery photo displaying with GameVisual™ Video intelligence Technology.
- **Racing Mode:** This is the best choice for racing game playing with GameVisual™ Video intelligence Technology.
- **Cinema Mode:** This is the best choice for movie watching with GameVisual™ Video intelligence Technology.
- **RTS/RPG Mode:** This is the best choice for Real-Time Strategy (RTS)/ Role-Playing Game (RPG) playing with GameVisual™ Video intelligence Technology.
- **FPS Mode:** This is the best choice for First Person Shooter game playing with GameVisual™ Video intelligence Technology.
- **sRGB Mode:** This is the best choice for viewing photos and graphics from PCs.
- **MOBA Mode:** This is the best choice for Multiplayer Online Battle Arena (MOBA) games playing with GameVisual™ Video intelligence Technology.
- **User:** More items are adjustable in the Color menu.



-
- In the Racing Mode, the Saturation, Sharpness, and ASCR functions are not user-configurable.
 - In the sRGB, the Saturation, Color Temp., Sharpness, Brightness, Contrast, and ASCR functions are not user-configurable.
-

2.1 Detaching the Stand (for VESA Wall Mount)



- Avoid damaging the monitor surface. While detaching the monitor stand, always keep the monitor inside its EPS packaging.

The detachable stand of this monitor is specially designed for VESA wall mount.

1. Disconnect power and signal cables. Carefully put the monitor facedown on its EPS packaging.
2. Remove the covers on where the monitor and the arm meet.
3. Remove the four (4) screws securing the arm to the rear of the monitor.
4. Detach the stand (arm and base) from the monitor.

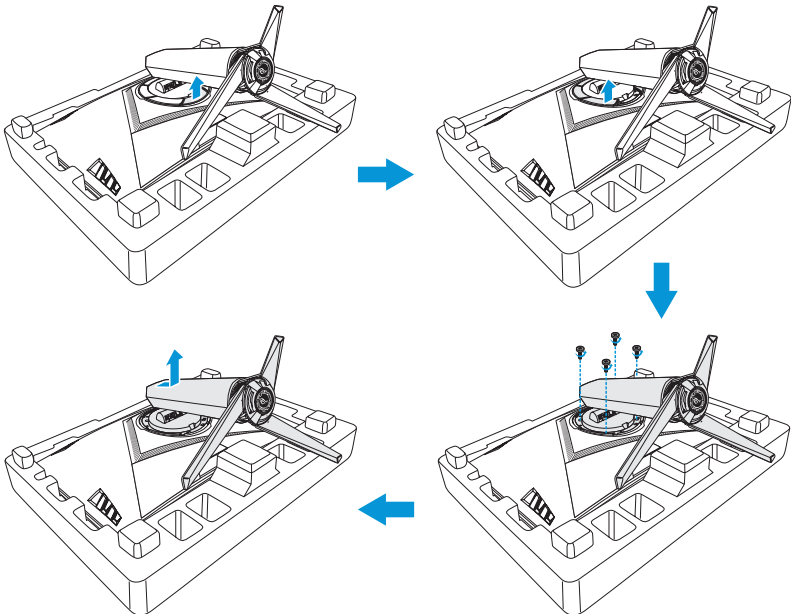



- The VESA wall mount kit (100 x 100 mm) is purchased separately.
- Use only the UL Listed Wall Mount Bracket with minimum weight/load 22.7kg (Screw size: M4 x 15 mm).

2.2 Adjusting the Monitor

- For optimal viewing, we recommend that you look at the full face of the monitor, then adjust the monitor to the angle that is most comfortable for you.
- Hold the stand to prevent the monitor from falling while changing its angle.
- The recommended adjusting angle is +20° to -5° (for tilt)/+50° to -50° (for swiveling), and adjustable height is 100 mm.

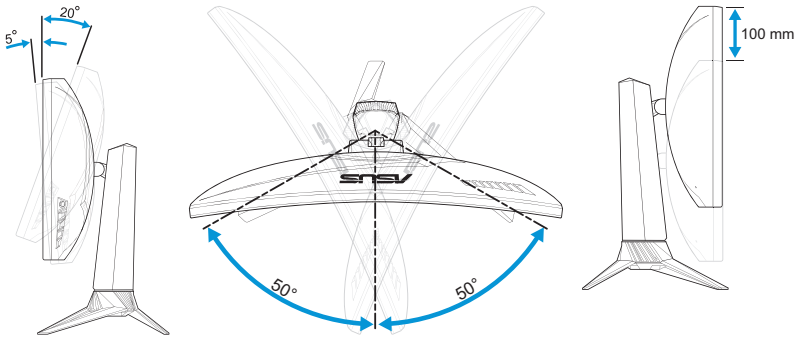







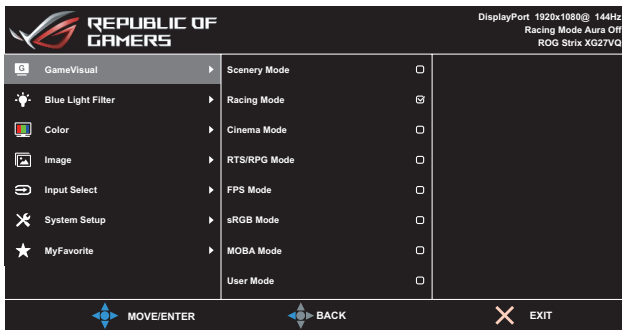

- It is normal that the monitor slightly shakes while you adjust the viewing angle.

3.1 OSD (On-Screen Display) Menu

3.1.1 How to Reconfigure



1. Press the  button to activate the OSD menu.
2. Move the  button up/down to navigate through the functions. Highlight the desired function and press the  button to activate it. If the function selected has a sub-menu, move the  button up/down again to navigate through the sub-menu functions. Highlight the desired sub-menu function and press the  button or move the  button right to activate it.
3. Move the  button up/down to change the settings of the selected function.
4. To exit and save the OSD menu, press the  button or move the  button left repeatedly until the OSD menu disappears. To adjust other functions, repeat steps 1 to 3.

3.1.2 OSD Function Introduction

1. GameVisual

This function contains eight sub-functions that you can select for your preference. For more information, please refer to page 1-7.

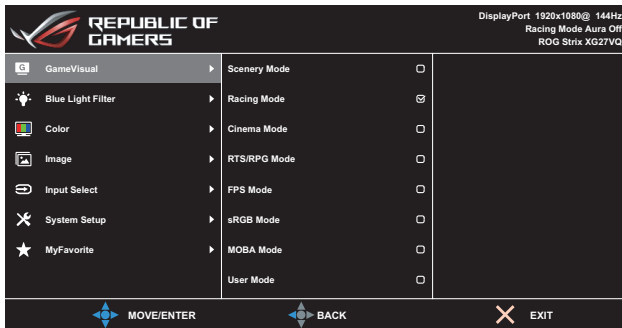

2. Blue Light Filter

Reduce the energy level of blue light emitted from LED backlight.

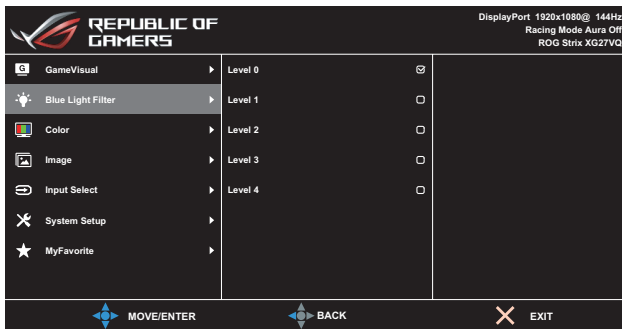

- **Level 0:** No change.
- **Level 1~4:** The higher the level, the more blue light will be reduced.



- When Blue Light Filter is activated, the default settings of Racing Mode will be automatically imported.
- Between Level 1 to Level 3, the Brightness function is user-configurable.
- Level 4 is optimized setting. It is compliance with TUV Low Blue Light Certification. The Brightness function is not user-configurable.



Please refer to the following to alleviate eye strains:

- Users should take some time away from the display if working for long hours. It is advised to take short breaks (at least 5 mins) after around 1 hour of continuous working at the computer. Taking short and frequent breaks is more effective than a single longer break.
- To minimize eye strain and dryness in your eyes, users should rest the eye periodically by focusing on objects that are far away.
- Eye exercises can help to reduce eye strain. Repeat these exercises often. If eye strain continues please consult a physician. Eye exercises: (1) Repeating look up and down (2) Slowly roll your eyes (3) Move your eyes diagonal.
- High energy blue light may lead to eye strain and AMD (Age-Related Macular Degeneration). Blue light filter to reduce 70% (max.) harmful blue light to avoiding CVS (Computer Vision Syndrome).

3. Color

Select the image color you like from this menu.

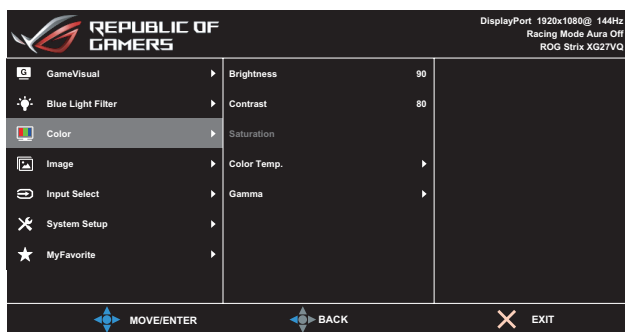

- **Brightness:** Adjust the brightness level. The adjusting range is from 0 to 100.

- **Contrast:** Adjust the contrast level. The adjusting range is from 0 to 100.
- **Saturation:** Adjust the saturation level. The adjusting range is from 0 to 100.
- **Color Temp.:** Select the desired color temperature. Available options: **Cool, Normal, Warm, and User Mode.**



- In the User Mode, colors of R (Red), G (Green), and B (Blue) are user-configurable; the adjusting range is from 0 to 100.

- **Gamma:** Allows you to set the color mode to 1.8, 2.2, or 2.5.

4. Image

You can set the image overdrive (OD) options, configure Aspect Control, ASCR, ELMB, and Adaptive-Sync from this menu.

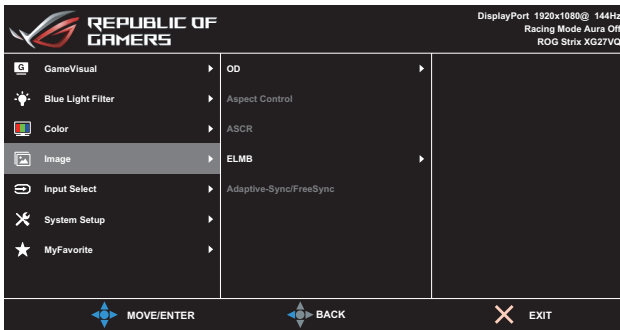

- **OD (Over Drive):** Speeds up the response time by Over Drive technology. The adjusting range is from lower **Level 0** to the fastest **Level 5**.
- **Aspect Control:** Adjust the aspect ratio to **Full** and **4:3**.



- 4:3 is only available when the input source is in 4:3 and 5:4 format.

- **ASCR:** Select **ON** or **OFF** to enable or disable dynamic contrast ratio function.
- **ELMB:** Check to decrease motion blur and minimize ghosting part when on-screen objects are fast-moving.



- If the Adaptive-Sync/FreeSync is enabled, the ELMB function is grayed out.

- **Adaptive-Sync/FreeSync:** Allows an Adaptive-Sync or FreeSync supported graphics source (HDMI and DisplayPort) to dynamically adjust display refresh rate based on typical content frame rates for power efficient, virtually stutter free and low-latency display update.



- If the Adaptive-Sync/FreeSync is enabled, the ELMB function is grayed out.

5. Input Select

Select the input source.

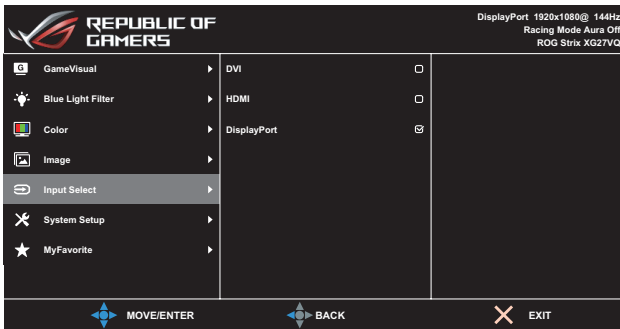

6. System Setup

Adjust the system configuration.

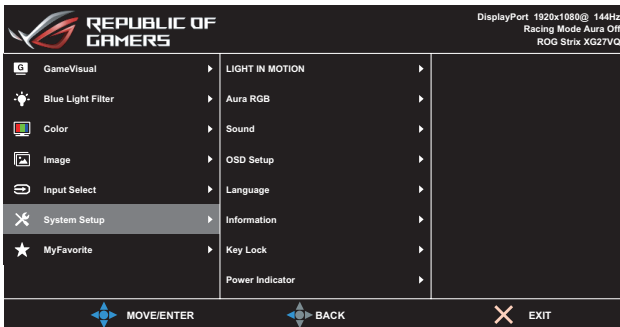

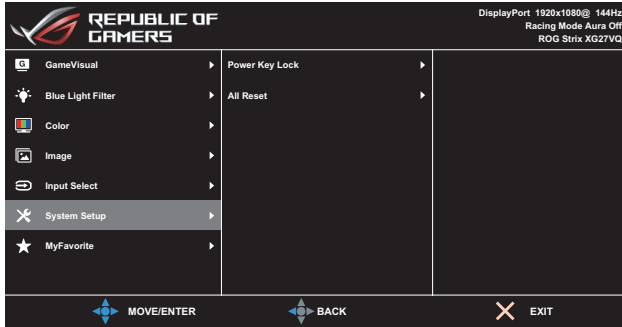



(Page 2/2)

- **LIGHT IN MOTION:** Set the red light intensity level on the base from **Level 1** to **Level 3**. To turn off the red light, set **Level 0**.
- **Aura RGB:** Set the Aura RGB light pattern on the rear of the monitor. Available options: **Rainbow, Color Cycle, Static, Breathing, Strobing, and Off.**



- For Aura RGB patterns, such as Static, Breathing, and Strobing you can set your preferred color. The color options include red (R), green (G), blue (B), cyan (C), magenta (M), and yellow (Y).

- **Sound:**
 - **Volume:** Adjust the volume level from 0 to 100.
 - **Mute:** Check to mute the volume.
- **OSD Setup:** Adjust the **OSD Timeout, DDC/CI, and Transparency** of the OSD screen.
- **Language:** Select the OSD language.
- **Information:** Display the monitor information.
- **Key Lock:** Pressing down the  () button for more than five seconds to activate or deactivate the key lock function.
- **Power Indicator:** Turn the power LED indicator on/off.
- **Power Key Lock:** Disable/Enable the power key.
- **All Reset:** Select **YES** to revert all settings to the factory default mode.

7. MyFavorite

Load/Save all settings on the monitor.

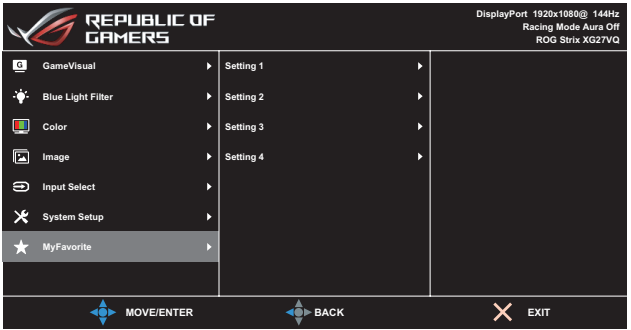

3.2 Specifications

Model		XG27VQ
Panel Size		27 inches diagonal (Active Display Area: 595.303 (H) x 336.312 (V) mm)
Max. Resolution		1920 (H) x 1080 (V)
Brightness (Typ.)		300 cd/m ²
Contrast Ratio (Typ.)		3000:1
Viewing Angle (CR≤10)		178°(H)/178°(V)
Display Colors		16.7M colors (8 bits+FRC)
Response Time		4ms (G to G)
Terminals	Inputs:	DVI x 1, HDMI x 1, DP x 1
	Audio input:	N/A
	Audio output:	Yes
Power consumption		50W (Max)
Standby power consumption		< 0.5W at AC110V~ AC220V
Power off power consumption		< 0.5W at AC110V~ AC220V
Phys. Dimension (incl. base) (HxWxD)		523.91 x 619.64 x 268.62 mm
Box Dimension (HxWxD)		560±0.5 x 752 ±0.5 x 268 ±0.5 mm
Net Weight (incl. stand)		6.9 ±0.5 kg
Gross Weight (Esti.)		9.95 ±1.0 kg
VESA Wall Mounting		Yes (100 mm x 100 mm)
Voltage Rating		DELTA: ADP-65GD B, 19Vdc 3.42A, AC100~240V at 50/60Hz Lite-on: PA-1650-48, 19Vdc 3.42A, AC100~240V at 50/60Hz
Temperature		Operating temperature: 0 ~ 40°C Storage temperature: -20 ~ 60°C

Model	XG27VQ
Accessories	Adapter, Power cord, Quick Start Guide, Warranty card, Support CD, HDMI cable (optional), DP cable (optional), LED projection cover and changeable films (optional), Input/Output ports cover
Compliance and Standards	CCC, China Energy Label, UL/C-UL, CB, BSMI, CU(EAC), MSIP(KCC), VCCI, FCC, CE RCM, E-Standby, GEMS, KC(EK), TUV Low Blue Light/Flicker-Free, RoHS, WEEE, EuP (Energy Saving Only), Ukr SEPRO, J-MOSS, Windows 7/8.1/10WHQL
Multi-Language OSD Support	English, French, German, Spanish, Italian, Dutch, Russian, Polish, Czech, Croatian, Hungarian, Romanian, Portuguese, Turkish, Traditional Chinese, Simplified Chinese, Japanese, Korean, Persian, Thai, and Indonesian

*Specifications subject to change without notice.

3.3 Troubleshooting (FAQ)

Problem	Possible Solution
Power LED is not ON	<ul style="list-style-type: none"> • Press the  button to check if the monitor is turned on. • Check if the adapter and power cord are properly connected to the monitor and the power outlet. • Check the Power Indicator function in the OSD menu. Select "ON" to turn on the power LED.
The power LED lights white and there is no screen image	<ul style="list-style-type: none"> • Check if the monitor and the computer are turned on. • Make sure the signal cable is properly connected the monitor and the computer. • Inspect the signal cable and make sure none of the pins are bent. • Connect the computer with another available monitor to check if the computer is properly working.
Screen image is too light or dark Screen image bounces or a wave pattern is present in the image	<ul style="list-style-type: none"> • Adjust the Contrast and Brightness settings via OSD. • Make sure the signal cable is properly connected to the monitor and the computer. • Move electrical devices that may cause electrical interference.
Screen image has color defects (white does not look white)	<ul style="list-style-type: none"> • Inspect the signal cable and make sure that none of the pins are bent. • Perform All Reset via OSD. • Select the appropriate color temperature (Color Temp.) via OSD.
No sound or sound is low	<ul style="list-style-type: none"> • Adjust the volume settings of your monitor or computer. • Make sure the computer sound card driver is properly installed and activated. • Check the audio source.

3.4 Supported Timing List

PC Supported Primary Timing

Timing List	DVI	HDMI 1.4	Display Port 1.2	Note
640x480@60Hz	V	V	V	
640x480@67Hz	V	V	V	
640x480@72Hz	V	V	V	
640x480@75Hz	V	V	V	
720x400@70Hz	V	V	V	
800x600@56Hz	V	V	V	
800x600@60Hz	V	V	V	
800x600@72Hz	V	V	V	
800x600@75Hz	V	V	V	
832x624@75Hz	V	V	V	
1024x768@60Hz	V	V	V	
1024x768@70Hz	V	V	V	
1024x768@75Hz	V	V	V	
1152x864@75Hz	V	V	V	
1280x720@60Hz	V	V	V	
1280x960@60Hz	V	V	V	
1280x1024@60Hz	V	V	V	
1280x1024@75Hz	V	V	V	
1440x900@60Hz	V	V	V	
1680x1050@60Hz	V	V	V	
1920x1080@60Hz	V	V	V	Default timing
1920x1080@75Hz	V	V	V	
1920x1080@85Hz	V	V	V	
1920x1080@100Hz	V	V	V	
1920x1080@120Hz	V	V	V	
1920x1080@144Hz	V	V	V	

Video Timing

Timing List	DVI	HDMI 1.4	Display Port 1.2	Note
640x480@59.94Hz	X	V	V	
640x480@60Hz	X	V	V	
720x480P@59.94Hz	X	V	V	
720x480P@60Hz	X	V	V	
720x576P@50Hz	X	V	V	
1280x720P@50Hz	X	V	V	
1280x720P@59.94Hz	X	V	V	
1280x720P@60Hz	X	V	V	
1440x480P@59.94Hz	X	V	V	
1440x480P@60Hz	X	V	V	
1440x576P@50Hz	X	V	V	
1920x1080i@50Hz	X	V	V	
1920x1080i@59.94Hz	X	V	V	
1920x1080i@60Hz	X	V	V	
1920x1080P@50Hz	X	V	V	
1920x1080P@59.94Hz	X	V	V	
1920x1080P@60Hz	X	V	V	

* Modes not listed in the table may not be supported. For optimal resolution, we recommend that you choose a mode listed in the table above.



REPUBLIC OF
GAMERS

