

ASUS[®]

**VZ249 Series
LCD Monitor**

User Guide

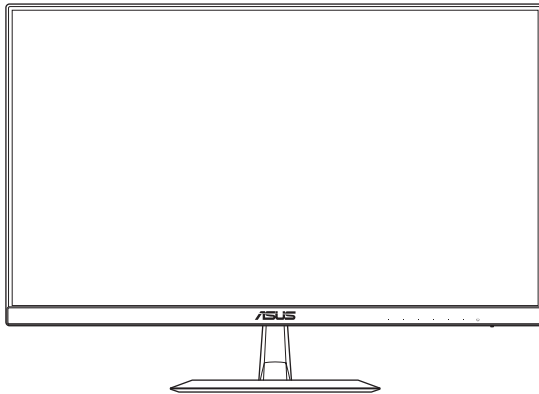

HDMI[™]
HIGH-DEFINITION MULTIMEDIA INTERFACE

Copyright © 2017 ASUSTeK COMPUTER INC. All Rights Reserved.

No part of this manual, including the products and software described in it, may be reproduced, transmitted, transcribed, stored in a retrieval system, or translated into any language in any form or by any means, except documentation kept by the purchaser for backup purposes, without the express written permission of ASUSTeK COMPUTER INC. ("ASUS").

Product warranty or service will not be extended if: (1) the product is repaired, modified or altered, unless such repair, modification or alteration is authorized in writing by ASUS; or (2) the serial number of the product is defaced or missing.

ASUS PROVIDES THIS MANUAL "AS IS" WITHOUT WARRANTY OF ANY KIND, EITHER EXPRESS OR IMPLIED, INCLUDING BUT NOT LIMITED TO THE IMPLIED WARRANTIES OR CONDITIONS OF MERCHANTABILITY OR FITNESS FOR A PARTICULAR PURPOSE. IN NO EVENT SHALL ASUS, ITS DIRECTORS, OFFICERS, EMPLOYEES OR AGENTS BE LIABLE FOR ANY INDIRECT, SPECIAL, INCIDENTAL, OR CONSEQUENTIAL DAMAGES (INCLUDING DAMAGES FOR LOSS OF PROFITS, LOSS OF BUSINESS, LOSS OF USE OR DATA, INTERRUPTION OF BUSINESS AND THE LIKE), EVEN IF ASUS HAS BEEN ADVISED OF THE POSSIBILITY OF SUCH DAMAGES ARISING FROM ANY DEFECT OR ERROR IN THIS MANUAL OR PRODUCT.

SPECIFICATIONS AND INFORMATION CONTAINED IN THIS MANUAL ARE FURNISHED FOR INFORMATIONAL USE ONLY, AND ARE SUBJECT TO CHANGE AT ANY TIME WITHOUT NOTICE, AND SHOULD NOT BE CONSTRUED AS A COMMITMENT BY ASUS. ASUS ASSUMES NO RESPONSIBILITY OR LIABILITY FOR ANY ERRORS OR INACCURACIES THAT MAY APPEAR IN THIS MANUAL, INCLUDING THE PRODUCTS AND SOFTWARE DESCRIBED IN IT.

Products and corporate names appearing in this manual may or may not be registered trademarks or copyrights of their respective companies, and are used only for identification or explanation and to the owners' benefit, without intent to infringe.

Table of Contents

Notices.....	iv
Safety Information	v
Care & Cleaning	vi
Takeback Services.....	vii
1.1 Welcome!	1-1
1.2 Package Contents	1-1
1.3 Assembling the Monitor Base.....	1-2
1.4 Connect Cables	1-3
1.4.1 Rear of the LCD Monitor	1-3
1.5 Monitor Introduction	1-4
1.5.1 Using the Control Buttons	1-4
1.5.2 QuickFit Function	1-6
21 Adjusting the Monitor	2-1
3.1 OSD (On-Screen Display) Menu.....	3-1
3.1.1 How to Reconfigure	3-1
3.1.2 OSD Function Introduction.....	3-2
3.2 Specifications.....	3-16
3.3 Troubleshooting (FAQ).....	3-17
3.4 Supported Timing List	3-18

Notices

Federal Communications Commission Statement

This device complies with Part 15 of the FCC Rules. Operation is subject to the following two conditions:

- This device may not cause harmful interference, and
- This device must accept any interference received including interference that may cause undesired operation.

This equipment has been tested and found to comply with the limits for a Class B digital device, pursuant to Part 15 of the FCC Rules. These limits are designed to provide reasonable protection against harmful interference in a residential installation. This equipment generates, uses and can radiate radio frequency energy and, if not installed and used in accordance with the instructions, may cause harmful interference to radio communications. However, there is no guarantee that interference will not occur in a particular installation. If this equipment does cause harmful interference to radio or television reception, which can be determined by turning the equipment off and on, the user is encouraged to try to correct the interference by one or more of the following measures:

- Reorient or relocate the receiving antenna.
- Increase the separation between the equipment and receiver.
- Connect the equipment to an outlet on a circuit different from that to which the receiver is connected.
- Consult the dealer or an experienced radio/TV technician for help.

This product implements power management functionality. In case of no signal input after 10 seconds, the product automatically goes to sleep/standby mode.



As an Energy Star® Partner, our company has determined that this product meets the Energy Star® guidelines for energy efficiency.

Canadian Department of Communications Statement

This digital apparatus does not exceed the Class B limits for radio noise emissions from digital apparatus set out in the Radio Interference Regulations of the Canadian Department of Communications.

This class B digital apparatus complies with Canadian ICES-003.

AEEE Yönetmeliine Uygundur

Safety Information

- Before setting up the monitor, carefully read all the documentation that came with the package.
- To prevent fire or shock hazard, never expose the monitor to rain or moisture.
- Never try to open the monitor cabinet. The dangerous high voltages inside the monitor may result in serious physical injury.
- If the power supply is broken, do not try to fix it by yourself. Contact a qualified service technician or your retailer.
- Before using the product, make sure all cables are correctly connected and the power cables are not damaged. If you detect any damage, contact your dealer immediately.
- Slots and openings on the back or top of the cabinet are provided for ventilation. Do not block these slots. Never place this product near or over a radiator or heat source unless proper ventilation is provided.
- The monitor should be operated only from the type of power source indicated on the label. If you are not sure of the type of power supply to your home, consult your dealer or local power company.
- Use the appropriate power plug which complies with your local power standard.
- Do not overload power strips and extension cords. Overloading can result in fire or electric shock.
- Avoid dust, humidity, and temperature extremes. Do not place the monitor in any area where it may become wet. Place the monitor on a stable surface.
- Unplug the unit during a lightning storm or if it will not be used for a long period of time. This will protect the monitor from damage due to power surges.
- Never push objects or spill liquid of any kind into the slots on the monitor cabinet.
- To ensure satisfactory operation, use the monitor only with UL listed computers which have appropriate configured receptacles marked between 100-240V AC.
- The socket-outlet shall be installed near the equipment and shall be easily accessible.
- If you encounter technical problems with the monitor, contact a qualified service technician or your retailer.
- This product may contain chemicals known to the State of California to cause cancer, and birth defects or other reproductive harm. Wash hands after handling.

Care & Cleaning

- Before you lift or reposition your monitor, it is better to disconnect the cables and power cord. Follow the correct lifting techniques when positioning the monitor. When lifting or carrying the monitor, grasp the edges of the monitor. Do not lift the display by the stand or the cord.
- Cleaning. Turn your monitor off and unplug the power cord. Clean the monitor surface with a lint-free, non-abrasive cloth. Stubborn stains may be removed with a cloth dampened with mild cleaner.
- Avoid using a cleaner containing alcohol or acetone. Use a cleaner intended for use with the LCD. Never spray cleaner directly on the screen, as it may drip inside the monitor and cause an electric shock.

The following symptoms are normal with the monitor:

- The screen may flicker during the initial use due to the nature of the fluorescent light. Turn off the Power Switch and turn it on again to make sure that the flicker disappears.
- You may find slightly uneven brightness on the screen depending on the desktop pattern you use.
- When the same image is displayed for hours, an afterimage of the previous screen may remain after switching the image. The screen will recover slowly or you can turn off the Power Switch for hours.
- When the screen becomes black or flashes, or cannot work anymore, contact your dealer or service center to fix it. Do not repair the screen by yourself!

Conventions used in this guide



WARNING: Information to prevent injury to yourself when trying to complete a task.



CAUTION: Information to prevent damage to the components when trying to complete a task.



IMPORTANT: Information that you **MUST** follow to complete a task.



NOTE: Tips and additional information to aid in completing a task.

Where to find more information

Refer to the following sources for additional information and for product and software updates.

1. **ASUS websites**

The ASUS websites worldwide provide updated information on ASUS hardware and software products. Refer to <http://www.asus.com>

2. **Optional documentation**

Your product package may include optional documentation that may have been added by your dealer. These documents are not part of the standard package.

Takeback Services

ASUS recycling and takeback programs come from our commitment to the highest standards for protecting our environment. We believe in providing solutions for our customers to be able to responsibly recycle our products, batteries and other components as well as the packaging materials.

Please go to <http://csr.asus.com/english/Takeback.htm> for detail recycling information in different region.

1.1 Welcome!

Thank you for purchasing the ASUS® LCD monitor!

The latest widescreen LCD monitor from ASUS provides a crisper, broader, and brighter display, plus a host of features that enhance your viewing experience.

With these features, you can enjoy the convenience and delightful visual experience that the monitor brings to you!

1.2 Package Contents

Check your package for the following items:

- ✓ LCD monitor
- ✓ Monitor Base
- ✓ Quick Start Guide
- ✓ Warranty Card
- ✓ Adaptor
- ✓ Power Cord (optional)
- ✓ VGA cable
- ✓ DVI cable (optional)
- ✓ HDMI cable (optional)
- ✓ Audio cable (optional)
- ✓ DP cable (optional)



- If any of the above items is damaged or missing, contact your retailer immediately.
-



CAUTION

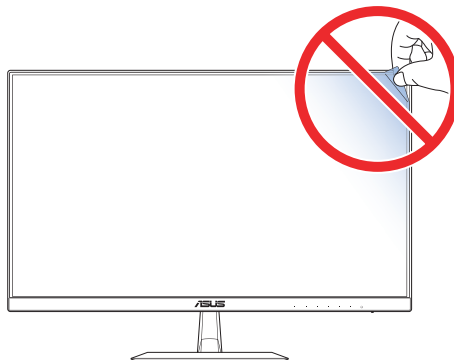

1.3 Assembling the Monitor Base

1. Have the front of the monitor face down on a table.
2. Attach the base to the arm.
3. Turn the screw clockwise to secure the base. Then adjust the monitor to the angle that is most comfortable for you.



- We recommend that you cover the table surface with soft cloth to prevent damage to the monitor.

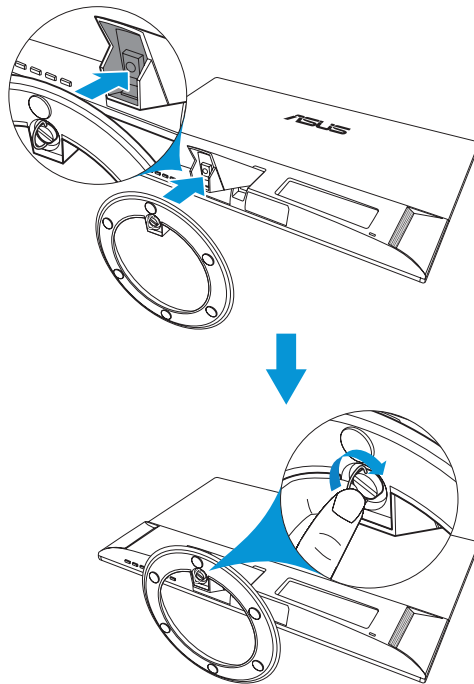

1.4 Connect Cables

1.4.1 Rear of the LCD Monitor

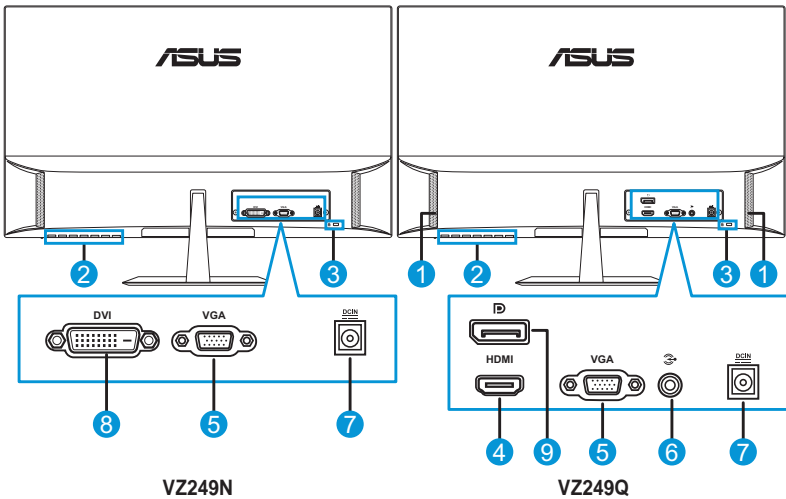
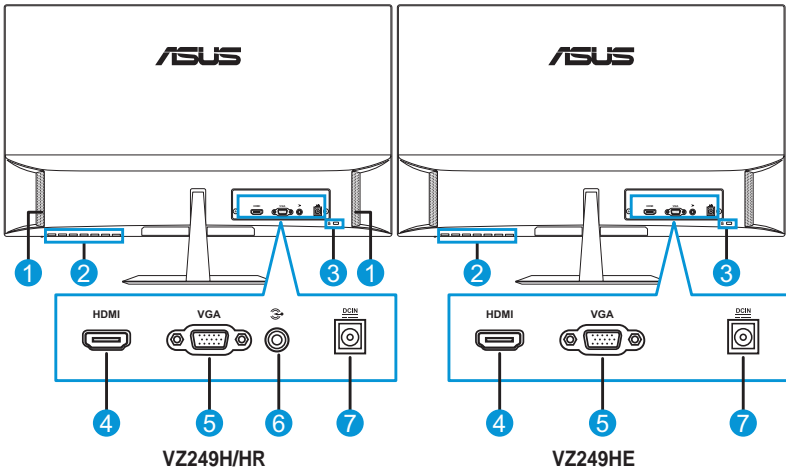

- 1. Speakers
- 2. Control buttons
- 3. Kensington Lock
- 4. HDMI port
- 5. VGA port
- 6. Audio-IN port
- 7. DC-IN port
- 8. DVI port
- 9. DisplayPort



1.5 Monitor Introduction

1.5.1 Using the Control Buttons

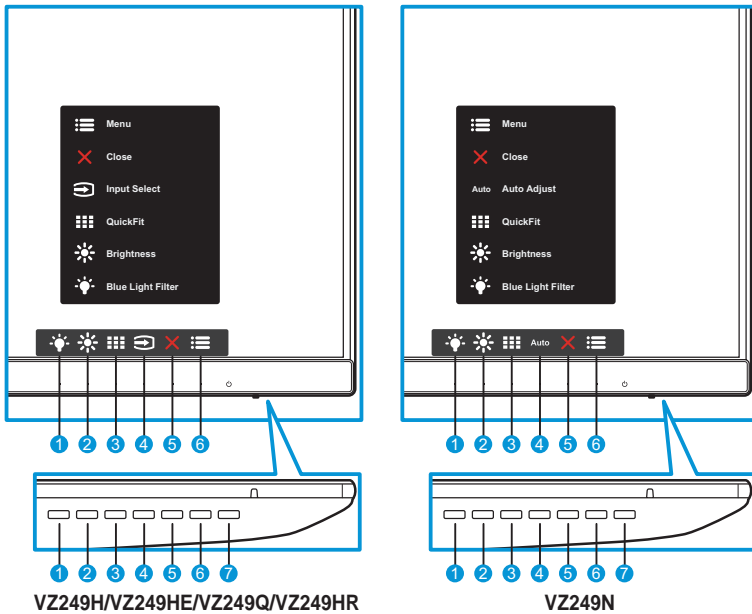
Use the control buttons on the bottom of the monitor to adjust the image settings. Press key 1-6 to activate the key list page.



1. Shortcut Key2:
 - This is a Shortcut key. The default setting is **Blue Light Filter**.
2. Shortcut Key1:
 - This is a Shortcut key. The default setting is **Brightness**.
3. QuickFit Button:
 - This is a hotkey to activate the **QuickFit** function designed for alignment.
 - The **QuickFit** function contains several options of common grid pattern, paper size, and photo size. See page 1-6 for details.
4. Input Button (for VZ249H/VZ249HE/VZ249Q model only): Switch the input source.
Auto Auto Adjust Button (for VZ249N model only): Automatically perform Auto Adjust (only available for VGA input).

5.  Close Button:
 - Exit the OSD menu.
6.  Menu Button:
 - Enter the OSD menu.
7.  Power Button/Power Indicator:
 - Press this button to turn the monitor on/off.
 - The color definition of the power indicator is as the table below.

Status	Description
White	ON
Amber	Standby mode
OFF	OFF

1.5.2 QuickFit Function

The QuickFit function contains three patterns: (1) Grid (2) Paper size (3) Photo size.

1. Grid pattern: Facilitates designers and users to organize content and layout on one page and achieve a consistent look and feel.



2. Paper size: Provides users to view their documents in real size on the screen.

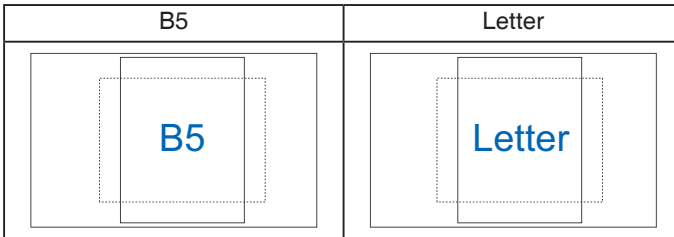

3. Photo size: Provides photographers and other users to accurately view and edit their photos in real size on the screen.

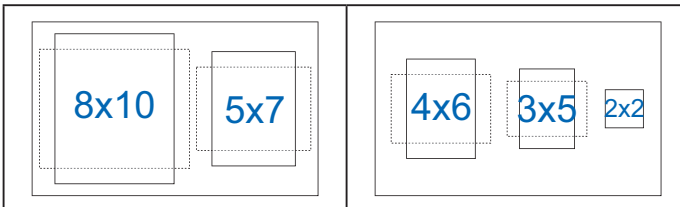

2.1 Adjusting the Monitor

- For optimal viewing, we recommend that you look at the full face of the monitor, then adjust the monitor to the angle that is most comfortable for you.
- Hold the stand to prevent the monitor from falling while changing its angle.
- You can adjust the monitor's angle from -5° to $+22^{\circ}$.

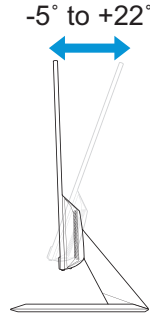

-
- It is normal that the monitor slightly shakes while you adjust the viewing angle.
-

3.1 OSD (On-Screen Display) Menu

3.1.1 How to Reconfigure

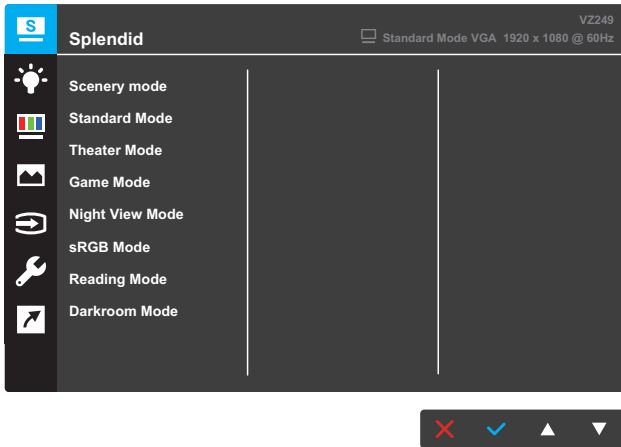

1. Press the **Menu** button to activate the OSD menu.
2. Press the **▼** and **▲** buttons to toggle between options in the Menu. As you move from one icon to another, the option name is highlighted.
3. To select the highlighted item on the menu, press the **✓** button.
4. Press the **▼** and **▲** buttons to select the desired parameter.
5. Press the **✓** button to enter the slide bar and then use the **▼** and **▲** buttons, according to the indicators on the menu, to make your changes.
6. Select **↶** to return to previous menu or **✓** to accept and return to previous menu.

3.1.2 OSD Function Introduction

1. Splendid

This function contains eight sub-functions that you can select for your preference. Each mode has the Reset selection, allowing you to maintain your setting or return to the preset mode.

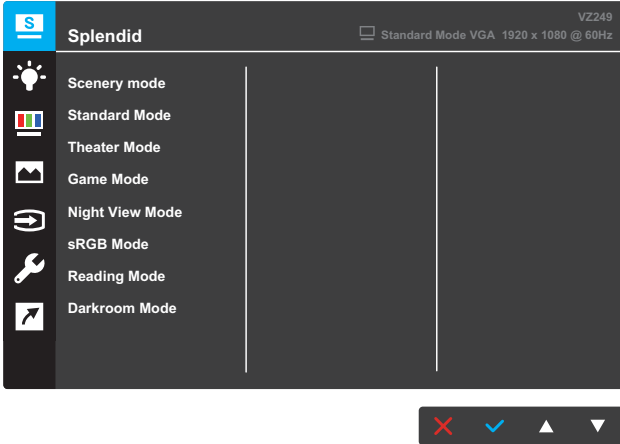

- **Scenery mode:** This is the best choice for scenery photo displaying with SPLENDID™ Video Intelligence Technology.
- **Standard Mode:** This is the best choice for document editing with SPLENDID™ Video Intelligence Technology.
- **Theater Mode:** This is the best choice for movie watching with SPLENDID™ Video Intelligence Technology.
- **Game Mode:** This is the best choice for game playing with SPLENDID™ Video Intelligence Technology.
- **Night View Mode:** This is the best choice for playing dark-scene game or watching dark-scene movie with SPLENDID™ Video Intelligence Technology.
- **sRGB Mode:** This is the best choice for viewing photos and graphics from PCs.
- **Reading Mode:** This is the best choice for book reading with SPLENDID™ Video Intelligence Technology.
- **Darkroom Mode:** This is the best choice for a weak ambient light environment with SPLENDID™ Video Intelligence Technology.



- In the Standard Mode, the Saturation, Skin Tone, Sharpness, and ASCR functions are not user-configurable.
- In the sRGB, the Saturation, Color Temp., SkinTone, Sharpness, Brightness, Contrast, and ASCR functions are not user-configurable.
- In the Reading Mode, the Saturation, SkinTone, ASCR, Contrast, and Color Temp. functions are not user-configurable.

2. Blue Light Filter

Reduce the energy level of blue light emitted from LED backlight.

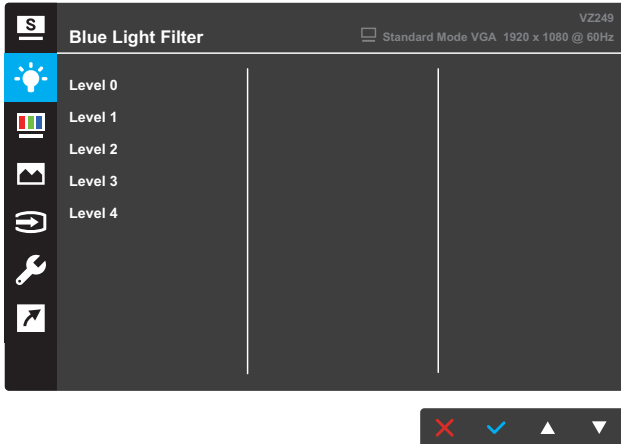

- **Level 0:** No change.
- **Level 1~4:** The higher the level, the more blue light will be reduced.



- When Blue Light Filter is activated, the default settings of Standard Mode will be automatically imported.
- Between Level 1 to Level 3, the Brightness function is user-configurable.
- Level 4 is optimized setting. It is compliance with TUV Low Blue Light Certification. The Brightness function is not user-configurable.
- To alleviate eye strain, rest your eyes for fifteen minutes for every two hours spent in front of the screen. Frequent blinking and eye exercise helps keep your eye moist to prevent them from drying out. In addition, your computer screen should be placed 20 to 28 inches (50-70cm) away from you.

3. Color

Select the image color you like from this function.

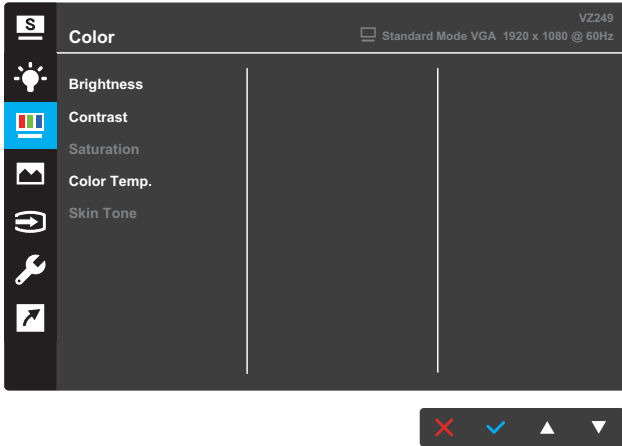

- **Brightness:** Adjust the brightness level. The adjusting range is from 0 to 100.
- **Contrast:** Adjust the contrast level. The adjusting range is from 0 to 100.
- **Saturation:** Adjust the saturation level. The adjusting range is from 0 to 100.
- **Color Temp.:** Select the desired color temperature. Available options: **Cool**, **Normal**, **Warm**, and **User Mode**.



- In the User Mode, colors of R (Red), G (Green), and B (Blue) are user-configurable; the adjusting range is from 0 ~ 100.

- **Skin Tone:** Select the desired skin color. Available options: **Reddish**, **Natural**, and **Yellowish**.

4. Image

You can adjust the image Sharpness, Trace Free, Aspect Control, VividPixel, ASCR, Adaptive-Sync (for VZ249Q model only), Position, Focus, and Auto Adjust from this main function.

VZ249H/VZ249HE/VZ249N/VZ249HR

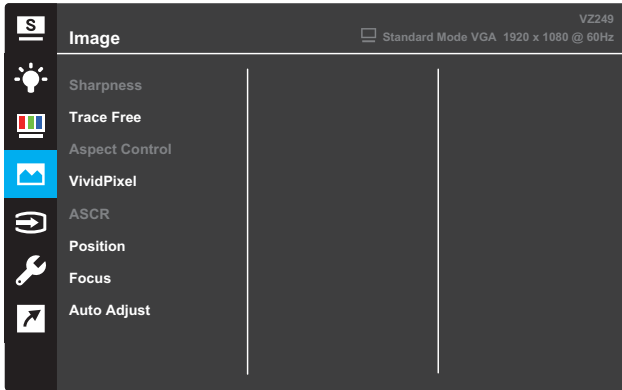

VZ249Q

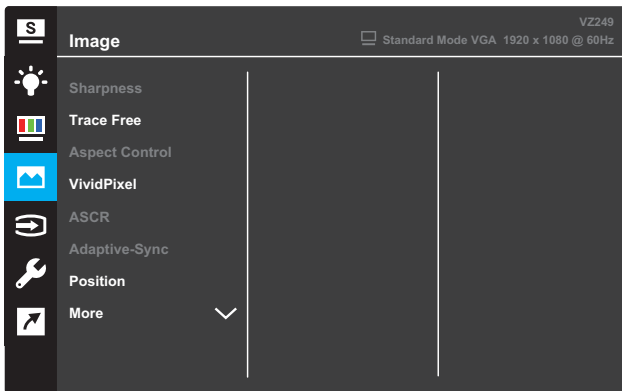

(Page 1/2)

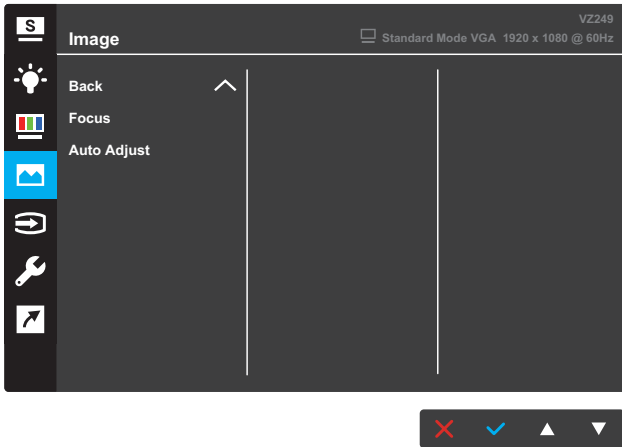

(Page 2/2)

- **Sharpness:** Adjust the picture sharpness. The adjusting range is from 0 to 100.
- **Trace Free:** Speed up the response time by Over Drive technology. The adjusting range is from lower 0 to faster 100.
- **Aspect Control:** Adjust the aspect ratio to “Full”, “4:3”, or “OverScan”.



-
- 4:3 is only available when the input source is in 4:3 format.
 - OverScan is only available for HDMI input.
-

- **VividPixel:** ASUS Exclusive Technology that brings lifelike visuals for crystal-clear and detail-oriented enjoyment. The adjusting range is from 0~100.
- **ASCR:** Select **ON** or **OFF** to enable or disable dynamic contrast ratio function.
- **Adaptive-Sync** (for VZ249Q model only): Select **ON** or **OFF** to enable or disable the dynamic refresh rate range from 40Hz to 60Hz through DisplayPort stream 1.2.
- **Position:** Adjust the horizontal position (H-Position) and the vertical position (V-Position) of the image. The adjusting range is from 0 to 100 (only available for VGA input).
- **More** (for VZ249Q model only): Return the next page of Image Setting.
- **Back** (for VZ249Q model only): Return the previous page of Image Setting.

- **Focus:** Reduce the Horizontal-line noise and Vertical-line noise of the image by adjusting (Phase) and (Clock) separately. The adjusting range is from 0 to 100 (only available for VGA input).
- **Auto Adjust:** Automatically perform Auto Adjust (only available for VGA input).

5. Input Select

Select the input source.

VZ249H/VZ249HE/VZ249HR

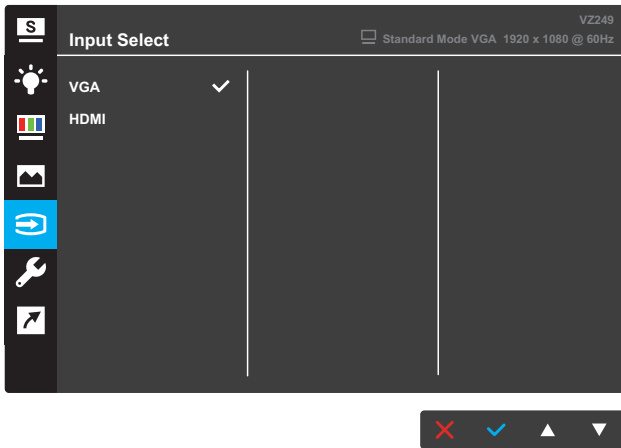

VZ249N

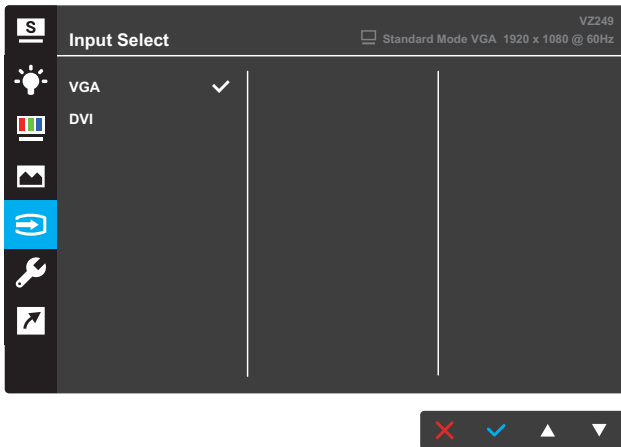

VZ249Q

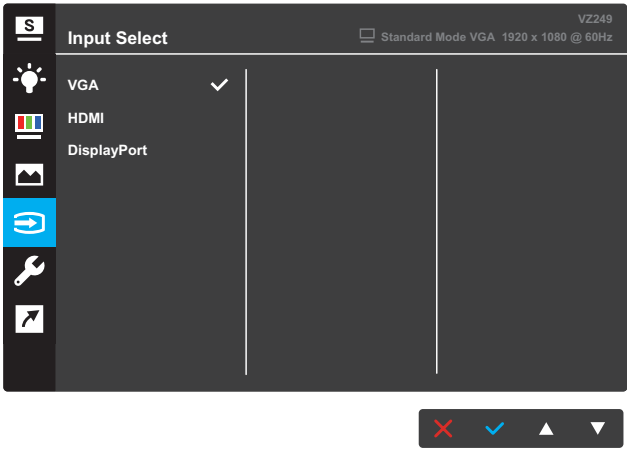

6. System Setup

Adjust the system configuration.

VZ249H/VZ249HR

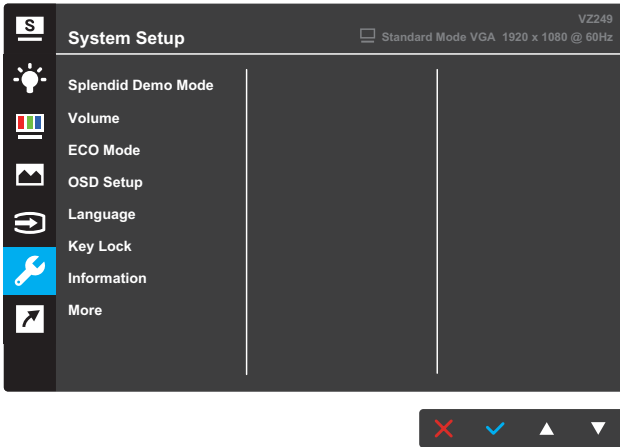

(Page 1/2)

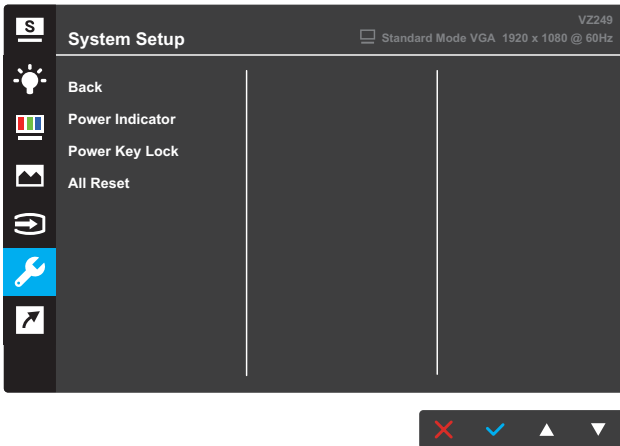

(Page 2/2)

VZ249N/VZ249HE

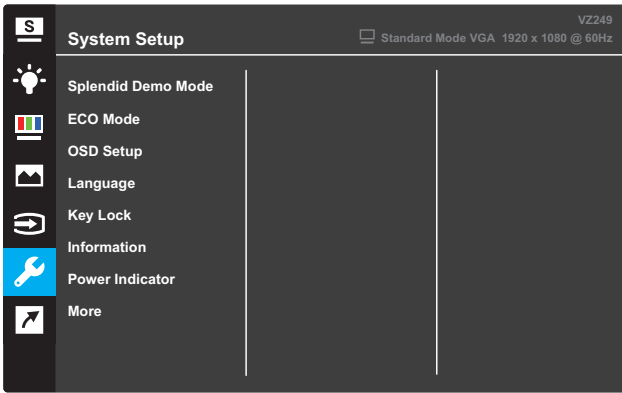

(Page 1/2)

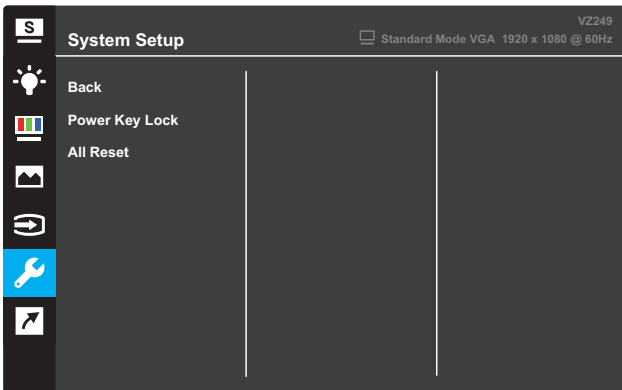

(Page 2/2)

VZ249Q

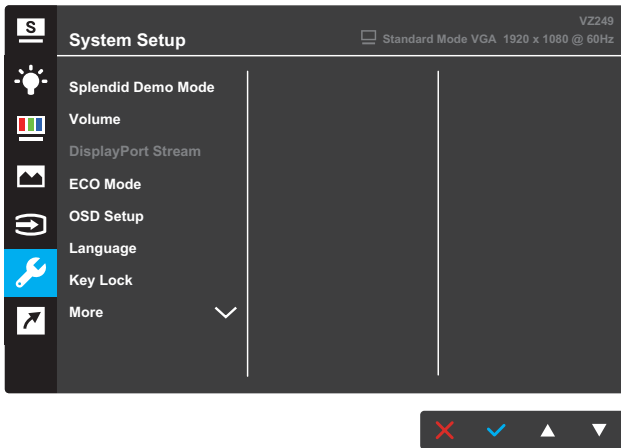

(Page 1/2)

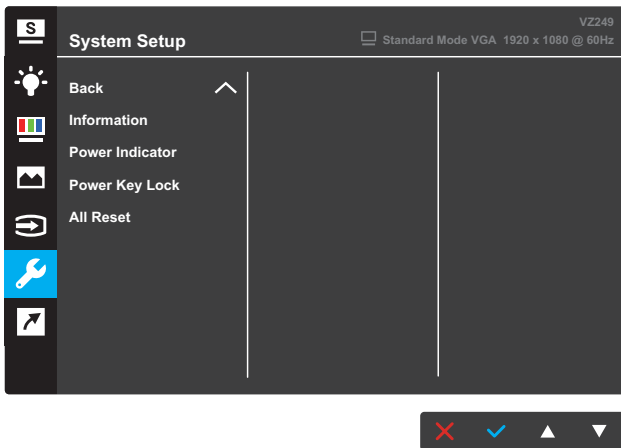

(Page 2/2)

- **Splendid Demo Mode:** Activate the demo mode for the Splendid function.
- **Volume** (for VZ249H/VZ249Q model only): Adjust the volume level.
- **DisplayPort Stream** (for VZ249Q model only): Select DP 1.1 or DP 1.2.
- **ECO Mode:** Activate the ecology mode for power saving.
- **OSD Setup:** Adjust the **OSD Timeout**, **DDC/CI**, and **Transparency** of the OSD screen.

- **Language:** Select the OSD language.
- **Key Lock:** Pressing the second button on the right for more than five seconds to activate the key lock function.
- **Information:** Display the monitor information.
- **More:** Return the next page of System Setting.
- **Back:** Return the previous page of System Setting.
- **Power Indicator:** Turn the power LED indicator on/off.
- **Power Key Lock:** Disable/Enable the power key.
- **All Reset:** Select **YES** to revert all settings to the factory default mode.

7. Shortcut

Assign the specific function to the two shortcut keys.

VZ249H/VZ249Q/VZ249HR

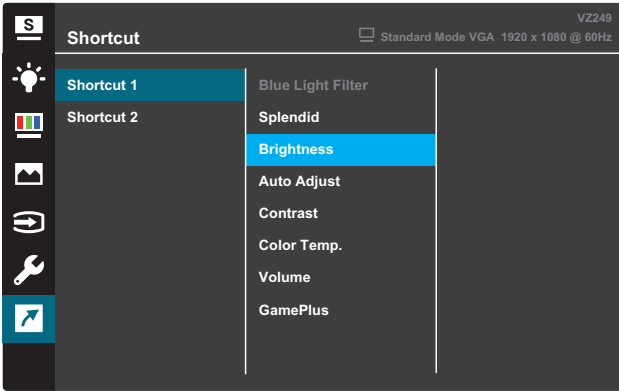

(Shortcut 1)

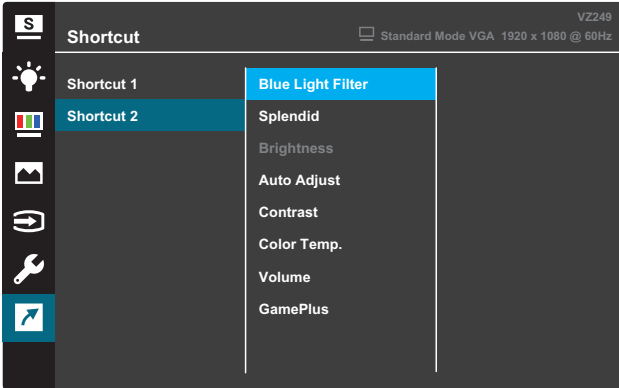

(Shortcut 2)

VZ249N/VZ249HE

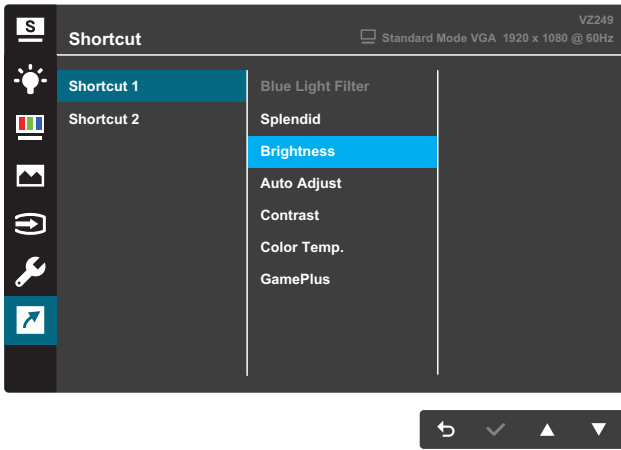

(Shortcut 1)

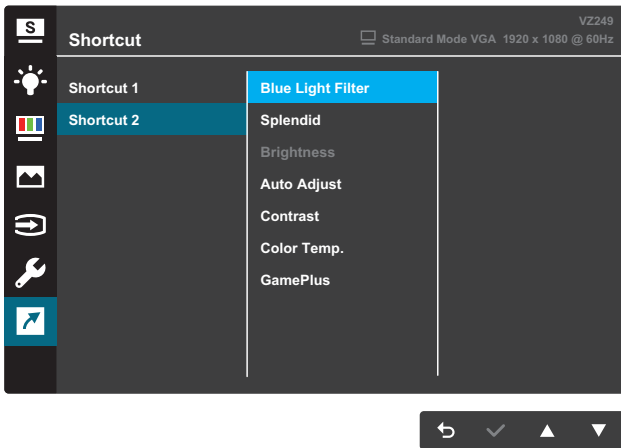

(Shortcut 2)

- **Shortcut 1:** Assign a function to the Shortcut Key1. Available options: **Blue Light Filter**, **Splendid**, **Brightness**, **Auto Adjust**, **Contrast**, **Color Temp.**, **Volume** (for VZ249H/VZ249Q model only), and **GamePlus**. The default setting is **Brightness**.
- **Shortcut 2:** Assign a function to the Shortcut Key2. Available options: **Blue Light Filter**, **Splendid**, **Brightness**, **Auto Adjust**, **Contrast**, **Color Temp.**, **Volume** (for VZ249H/VZ249Q model only), and **GamePlus**. The default setting is **Blue Light Filter**.

3.1.2.1 GamePlus Function

The GamePlus Function provides a toolkit and creates a better gaming environment for users when playing different types of games. The Crosshair overlay with four different crosshair options lets you choose the one that best suits the game you're playing. The onscreen Timer can be positioned on the left of the display to keep track of the elapsed gaming time. The FPS (frames per second) counter lets you know how smooth the game is running (for VZ249Q model only).

To activate GamePlus:

1. Press the **Menu** button to activate the OSD menu.
2. Press the **▼** or **▲** button to select **Shortcut**. Then press the **✓** button to enter the **Shortcut** menu.
3. Press the **▼** or **▲** button to select **Shortcut 1** or **Shortcut 2**.
4. Press the **✓** button to enter the **Shortcut 1** or **Shortcut 2** submenu.
5. Press the **▼** or **▲** button to select **GamePlus**. Then press the **✓** button to confirm the **GamePlus** submenu.
6. Press the **▼** or **▲** button to select **Crosshair**, **Timer**, or **FPS Counter** (for VZ249Q model only). Then press the **✓** button to confirm the selection.
7. Press the **↶** button repeatedly to exit the OSD menu.
8. Press the assigned **Shortcut Key1** or **Shortcut Key2** to activate the GamePlus main menu.

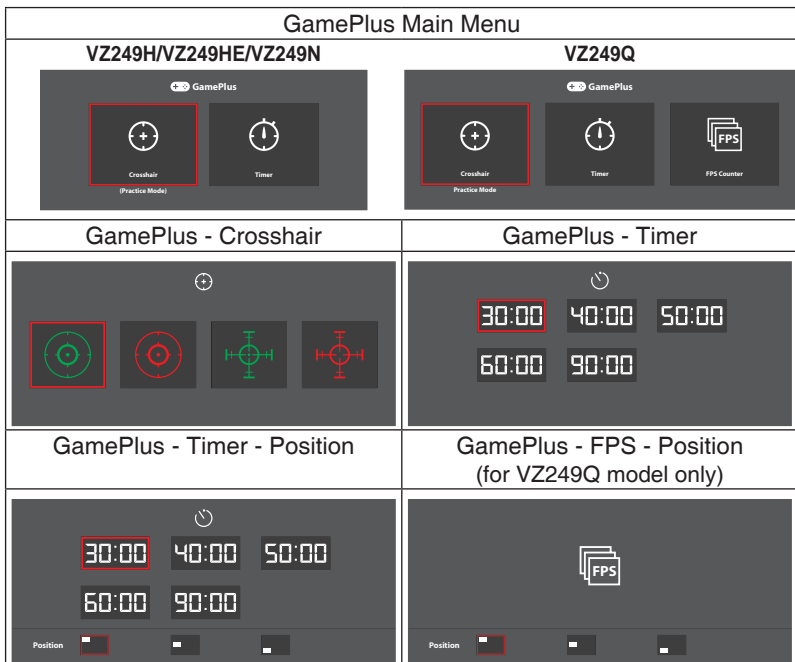

3.2 Specifications

Model		VZ249H/HR	VZ249HE	VZ249N	VZ249Q
Panel Size		23.8 inches diagonal (Active Display Area: 527.04 (H) x 296.46 (V) mm)			
Max. Resolution		1920 x 1080			
Brightness (Typ.)		250 cd/m ²			
Contrast Ratio (Typ.)		1000:1			
Viewing Angle (CR ≤ 10)		178°(V); 178°(H)			
Display Colors		16.7M colors (6 bits + Advanced-FRC)			
Response Time		5ms (GTG σ)			
Terminals	Inputs:	VGA x 1, HDMI x 1	VGA x 1, HDMI x 1	VGA x 1, DVI x 1	VGA x 1, HDMI x 1, DP x 1
	Audio input:	Yes	N/A	N/A	Yes
Audio Speaker	Speaker output:	1.5W x 2	N/A	N/A	1.5W x 2
Power consumption**		25W (Max) in Test Line Pattern with audio	22W (Max) in Test Line Pattern without audio	21W (Max) in Test Line Pattern without audio	25W (Max) in Test Line Pattern with audio
Standby power consumption		< 0.5W at AC110V~ AC220V			
Power off power consumption		< 0.5W at AC110V~ AC220V			
Phys. Dimension (incl. base) (HxWxD)		391 x 540 x 211 mm			
Box Dimension (HxWxD)		505 x 607 x 128±5 mm			
Net Weight (incl. stand)		2.90 ±1.0 kg			
Gross Weight (Esti.)		4.40 ±1.0 kg			
Voltage Rating		Delta: ADP-40KD BB, 19Vdc 2.1A, AC100~240V at 50/60Hz Delta: ADP-33W A/B/C, 19Vdc 1.75A, AC100~240V at 50/60Hz (VZ249HE/HR) Lite-on: PA1330-39 AE/AC/AU, 19Vdc 1.75A, AC100~240V at 50/60Hz (VZ249HE/HR)			
Temperature		Operating temperature: 0 ~ 40°C Storage temperature: -30 ~ 65°C			
Accessories		Adaptor, Power cord (optional), VGA cable, Quick Start Guide, Warranty card, DVI cable (optional), HDMI cable (optional), Audio cable (optional), DP cable (optional)			

Model	VZ249H/HR	VZ249HE	VZ249N	VZ249Q
Compliance and Standards	UkrSEPRO, CE, CB, BSMI, FCC, CCC, VCCI, RCM(C-tick), UL/cUL, MSIP(KCC), Energy Star 7.0, HDMI, DP, Windows Vista & 7/8/10 WHQL, China Energy Label, E-Standby, KC, GEMS, RoHS(China RoHS, J-Moss), WEEE, ErP(Energy Saving Only), CU			

*Specifications subject to change without notice.

** measuring a screen brightness of 200 nits without audio/ USB/ Card reader connection.

3.3 Troubleshooting (FAQ)

Problem	Possible Solution
Power LED is not ON	<ul style="list-style-type: none"> Press the  button to check if the monitor is turned on. Check if the adapter and power cord are properly connected to the monitor and the power outlet. Check the Power Indicator function in the OSD menu. Select "ON" to turn on the power LED.
The power LED lights amber and there is no screen image	<ul style="list-style-type: none"> Check if the monitor and the computer are turned on. Make sure the signal cable is properly connected the monitor and the computer. Inspect the signal cable and make sure none of the pins are bent. Connect the computer with another available monitor to check if the computer is properly working.
Screen image is too light or dark	<ul style="list-style-type: none"> Adjust the Contrast and Brightness settings via OSD.
Screen image bounces or a wave pattern is present in the image	<ul style="list-style-type: none"> Make sure the signal cable is properly connected to the monitor and the computer. Move electrical devices that may cause electrical interference.
Screen image has color defects (white does not look white)	<ul style="list-style-type: none"> Inspect the signal cable and make sure that none of the pins are bent. Perform Reset via OSD. Select the appropriate color temperature (Color Temp.) via OSD.
No sound or sound is low	<ul style="list-style-type: none"> Adjust the volume settings of your monitor or computer. Make sure the computer sound card driver is properly installed and activated.

3.4 Supported Timing List

VESA / IBM Modes Support Timing

Mode	Resolution (active dot)	Resolution (total dot)	Horizontal Frequency (KHz)	Vertical Frequency (Hz)	Nominal Pixel Color (MHz)
DOS	720x400@70Hz	900 x 449	31.469	70.087	28.322
VGA	640x480@60Hz	800 x 525	31.469	59.940	25.175
	640x480@72Hz	832 x 520	37.861	72.809	31.500
	640x480@75Hz	840 x 500	37.500	75.000	31.500
SVGA	800x600@56Hz	1024 x 625	35.156	56.250	36.000
	800x600@60Hz	1056 x 628	37.879	60.317	40.000
	800x600@72Hz	1040 x 666	48.077	72.188	50.000
	800x600@75Hz	1056 x 625	46.875	75.000	49.500
XGA	1024x768@60Hz	1344 x 806	48.363	60.004	65.000
	1024x768@70Hz	1328 x 806	56.476	70.069	75.000
	1024x768@75Hz	1312 x 800	60.023	75.029	78.750
VESA	1152x864@75Hz	1600 x 900	67.5	75.000	108.00
SXGA	1280x1024@60Hz	1688 x 1066	63.981	60.020	108.000
	1280x1024@75Hz	1688 x 1066	79.976	75.025	135.00
	1280x960@60Hz	1800 x 1000	60.000	60.000	108.00
WXGA	1280x800@60Hz	1680 x 831	49.702	59.810	83.500
	1280x720@60Hz	1650 x 750	45.00	60.000	74.25
	1280x768@60Hz	1664 x 798	47.776	59.870	79.5
	1360x768@60Hz	1792 x 795	47.712	60.015	85.500
	1366x768@60Hz	1792 x 798	47.712	59.790	85.500
WXGA+	1440x900@60Hz	1904 x 934	55.935	59.887	106.500
UXGA	1600x1200@60Hz	2160 x 1250	75.000	60.000	162.000
WSXGA+	1680x1050@60Hz	2240 x 1089	65.290	59.954	146.250
WUXGA	1920x1080@60Hz	2200 x 1125	67.500	60.000	148.500
MAC	640x480@66.66Hz	864 x 525	35	66.66	30.24
SVGA	832x624@75Hz	1152 x 667	49.714	74.533	57.27

* Modes not listed in the table may not be supported. For optimal resolution, we recommend that you choose a mode listed in the table above.