

ASUS®

PA279CV Series LCD Monitor

User Guide

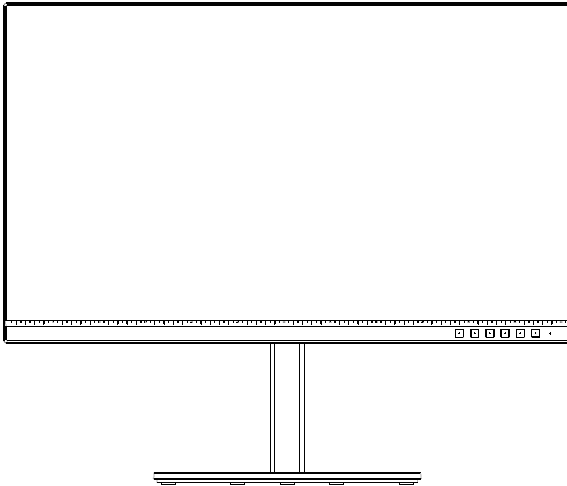

HDMI™
HIGH-DEFINITION MULTIMEDIA INTERFACE

Table of contents

Notices	iv
Safety information	v
Care & Cleaning	vii
1.1 Welcome!	1-1
1.2 Package contents.....	1-1
1.3 Assembling the monitor.....	1-2
1.4 Connect cables.....	1-3
1.4.1 Rear of the LCD monitor.....	1-3
1.5 Monitor introduction	1-4
1.5.1 Using the Controls button	1-4
2.1 Adjusting the monitor.....	2-1
2.2 Detaching the arm/stand (for VESA wall mount)	2-2
2.3 Outline dimension.....	2-3
3.1 OSD (On-Screen Display) menu	3-1
3.1.1 How to reconfigure.....	3-1
3.1.2 OSD Function Introduction.....	3-2
3.2 Specifications.....	3-13
3.3 Troubleshooting (FAQ).....	3-14
3.4 Supported Timing List.....	3-15

Copyright © 2020 ASUSTeK COMPUTER INC. All Rights Reserved.

No part of this manual, including the products and software described in it, may be reproduced, transmitted, transcribed, stored in a retrieval system, or translated into any language in any form or by any means, except documentation kept by the purchaser for backup purposes, without the express written permission of ASUSTeK COMPUTER INC. ("ASUS").

Product warranty or service will not be extended if: (1) the product is repaired, modified or altered, unless such repair, modification of alteration is authorized in writing by ASUS; or (2) the serial number of the product is defaced or missing.

ASUS PROVIDES THIS MANUAL "AS IS" WITHOUT WARRANTY OF ANY KIND, EITHER EXPRESS OR IMPLIED, INCLUDING BUT NOT LIMITED TO THE IMPLIED WARRANTIES OR CONDITIONS OF MERCHANTABILITY OR FITNESS FOR A PARTICULAR PURPOSE. IN NO EVENT SHALL ASUS, ITS DIRECTORS, OFFICERS, EMPLOYEES OR AGENTS BE LIABLE FOR ANY INDIRECT, SPECIAL, INCIDENTAL, OR CONSEQUENTIAL DAMAGES (INCLUDING DAMAGES FOR LOSS OF PROFITS, LOSS OF BUSINESS, LOSS OF USE OR DATA, INTERRUPTION OF BUSINESS AND THE LIKE), EVEN IF ASUS HAS BEEN ADVISED OF THE POSSIBILITY OF SUCH DAMAGES ARISING FROM ANY DEFECT OR ERROR IN THIS MANUAL OR PRODUCT.

SPECIFICATIONS AND INFORMATION CONTAINED IN THIS MANUAL ARE FURNISHED FOR INFORMATIONAL USE ONLY, AND ARE SUBJECT TO CHANGE AT ANY TIME WITHOUT NOTICE, AND SHOULD NOT BE CONSTRUED AS A COMMITMENT BY ASUS. ASUS ASSUMES NO RESPONSIBILITY OR LIABILITY FOR ANY ERRORS OR INACCURACIES THAT MAY APPEAR IN THIS MANUAL, INCLUDING THE PRODUCTS AND SOFTWARE DESCRIBED IN IT.

Products and corporate names appearing in this manual may or may not be registered trademarks or copyrights of their respective companies, and are used only for identification or explanation and to the owners' benefit, without intent to infringe.

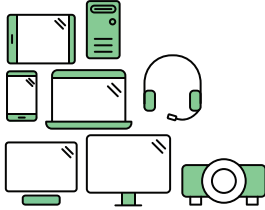

Say hello to a more sustainable product

IT products are associated with a wide range of sustainability risks throughout their life cycle. Human rights violations are common in the factories. Harmful substances are used both in products and their manufacture. Products can often have a short lifespan because of poor ergonomics, low quality and when they are not able to be repaired or upgraded.

This product is a better choice. It meets all the criteria in TCO Certified, the world's most comprehensive sustainability certification for IT products. Thank you for making a responsible product choice, that help drive progress towards a more sustainable future!

Criteria in TCO Certified have a life-cycle perspective and balance environmental and social responsibility. Conformity is verified by independent and approved verifiers that specialize in IT products, social responsibility or other sustainability issues. Verification is done both before and after the certificate is issued, covering the entire validity period. The process also includes ensuring that corrective actions are implemented in all cases of factory non-conformities. And last but not least, to make sure that the certification and independent verification is accurate, both TCO Certified and the verifiers are reviewed regularly.

Want to know more?

Read information about TCO Certified, full criteria documents, news and updates at [tcocertified.com](https://www.tcocertified.com). On the website you'll also find our Product Finder, which presents a complete, searchable listing of certified products.

Notices

Federal Communications Commission Statement

This device complies with Part 15 of the FCC Rules. Operation is subject to the following two conditions:

- This device may not cause harmful interference, and
- This device must accept any interference received including interference that may cause undesired operation.

This equipment has been tested and found to comply with the limits for a Class B digital device, pursuant to Part 15 of the FCC Rules. These limits are designed to provide reasonable protection against harmful interference in a residential installation. This equipment generates, uses and can radiate radio frequency energy and, if not installed and used in accordance with manufacturer's instructions, may cause harmful interference to radio communications. However, there is no guarantee that interference will not occur in a particular installation. If this equipment does cause harmful interference to radio or television reception, which can be determined by turning the equipment off and on, the user is encouraged to try to correct the interference by one or more of the following measures:

- Reorient or relocate the receiving antenna.
- Increase the separation between the equipment and receiver.
- Connect the equipment to an outlet on a circuit different from that to which the receiver is connected.
- Consult the dealer or an experienced radio/TV technician for help.

Canadian Department of Communications Statement

This digital apparatus does not exceed the Class B limits for radio noise emissions from digital apparatus set out in the Radio Interference Regulations of the Canadian Department of Communications.

This class B digital apparatus complies with Canadian ICES-003.

The device may fall, causing serious personal injury or death. To prevent injury, this device must be securely attached to the floor/wall in accordance with the installation instructions.



Safety information

- Before setting up the monitor, carefully read all the documentation that came with the package.
- To prevent fire or shock hazard, never expose the monitor to rain or moisture.
- Never try to open the monitor cabinet. The dangerous high voltages inside the monitor may result in serious physical injury.
- If the power supply is broken, do not try to fix it by yourself. Contact a qualified service technician or your retailer.
- Before using the product, make sure all cables are correctly connected and the power cables are not damaged. If you detect any damage, contact your dealer immediately.
- Slots and openings on the back or top of the cabinet are provided for ventilation. Do not block these slots. Never place this product near or over a radiator or heat source unless proper ventilation is provided.
- The monitor should be operated only from the type of power source indicated on the label. If you are not sure of the type of power supply to your home, consult your dealer or local power company.
- Use the appropriate power plug which complies with your local power standard.
- Do not overload power strips and extension cords. Overloading can result in fire or electric shock.
- Avoid dust, humidity, and temperature extremes. Do not place the monitor in any area where it may become wet. Place the monitor on a stable surface.
- Unplug the unit during a lightning storm or if it will not be used for a long period of time. This will protect the monitor from damage due to power surges.
- Never push objects or spill liquid of any kind into the slots on the monitor cabinet.
- To ensure satisfactory operation, use the monitor only with UL listed computers which have appropriate configured receptacles marked between 100 ~ 240V AC.
- The socket-outlet shall be installed near the equipment and shall be easily accessible
- If you encounter technical problems with the monitor, contact a qualified service technician or your retailer.
- Provide an earthing connection before the mains plug is connected to the mains. And, when disconnecting the earthing connection, be sure to disconnect after pulling out the mains plug from the mains.

WARNING

Usage of other than specified head- or earphones can result in hearing loss due to excessive sound pressures.

Care & Cleaning

- Before you lift or reposition your monitor, it is better to disconnect the cables and power cord. Follow the correct lifting techniques when positioning the monitor. When lifting or carrying the monitor, grasp the edges of the monitor. Do not lift the display by the stand or the cord.
- Cleaning. Turn your monitor off and unplug the power cord. Clean the monitor surface with a lint-free, non-abrasive cloth. Stubborn stains may be removed with a cloth dampened with mild cleaner.
- Avoid using a cleaner containing alcohol or acetone. Use a cleaner intended for use with the LCD. Never spray cleaner directly on the screen, as it may drip inside the monitor and cause an electric shock.

The following symptoms are normal with the monitor:

- The screen may flicker during the initial use due to the nature of the fluorescent light. Turn off the Power Switch and turn it on again to make sure that the flicker disappears.
- You may find slightly uneven brightness on the screen depending on the desktop pattern you use.
- When the same image is displayed for hours, an afterimage of the previous screen may remain after switching the image. The screen will recover slowly or you can turn off the Power Switch for hours.
- When the screen becomes black or flashes, or cannot work anymore, contact your dealer or service center to fix it. Do not repair the screen by yourself!

Conventions used in this guide



WARNING: Information to prevent injury to yourself when trying to complete a task.



CAUTION: Information to prevent damage to the components when trying to complete a task.



IMPORTANT: Information that you **MUST** follow to complete a task.



NOTE: Tips and additional information to aid in completing a task.

Where to find more information

Refer to the following sources for additional information and for product and software updates.

1. ASUS websites

The ASUS websites worldwide provide updated information on ASUS hardware and software products. Refer to **<http://www.asus.com>**

2. Optional documentation

Your product package may include optional documentation that may have been added by your dealer. These documents are not part of the standard package.

Takeback Services

ASUS recycling and takeback programs come from our commitment to the highest standards for protecting our environment. We believe in providing solutions for our customers to be able to responsibly recycle our products, batteries and other components as well as the packaging materials.

Please go to <http://csr.asus.com/english/Takeback.htm> for detail recycling information in different region.

1.1 Welcome!

Thank you for purchasing the ASUS® LCD monitor!

The latest widescreen LCD monitor from ASUS provides a crisper, broader, and brighter display, plus a host of features that enhance your viewing experience.

With these features, you can enjoy the convenience and delightful visual experience that the monitor brings you!

1.2 Package contents

Check your package for the following items:

- ✓ LCD Monitor
- ✓ Stand/Base
- ✓ Quick Start Guide
- ✓ Warranty Card
- ✓ 1 x USB Type-C Cable(optional)
- ✓ 1x Power Cord
- ✓ 1x HDMI Cable (optional)
- ✓ 1x DP Cable (optional)
- ✓ Color calibration testing report
- ✓ ProArt welcome card



-
- If any of the above items is damaged or missing, contact your retailer immediately.
-

1.3 Assembling the monitor

To assemble the monitor:

1. Align the screw hole on the arm with the bundled screw on the base. Then insert the base into the arm.
2. Fix the base to the arm by fastening the bundled screw.

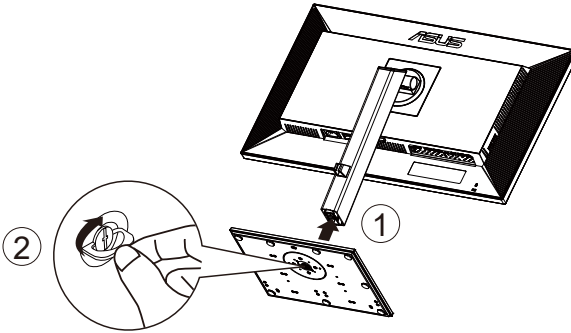

*Base screw size: M6 x 17mm

1.4 Connect cables

1.4.1 Rear of the LCD monitor

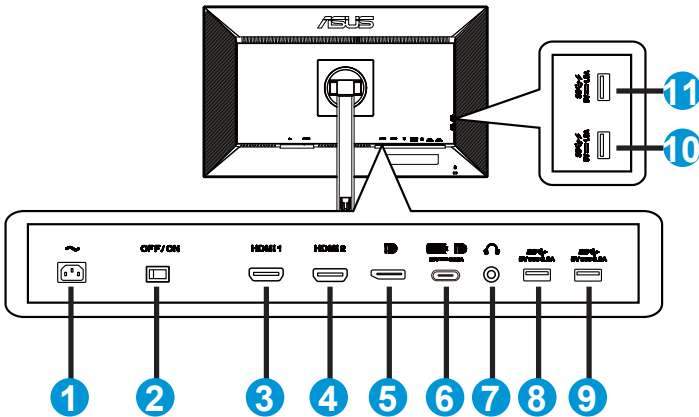

1. AC-IN Port
2. Power Switch
3. HDMI 1 Port
4. HDMI 2 Port
5. DP - in Port
6. USB3.1 Type-C
7. Earphone - out Port
8. USB3.1 Type A
9. USB3.1 Type A
10. USB3.1 Type A
11. USB3.1 Type A



This monitor is Super-Speed USB 3.1 compatible (5 Gbps). The port offers Max. 65W power delivery with output voltage 5V/3A, 9V/3A, 12V/3A, 15V/3A and 20V/3.25A. Connecting the USB Type-C cable can input the DisplayPort source, output power and enable the USB Type-A ports (downstream) on the monitor. Connecting the USB Type-C to Type-A cable only enables the USB Type-A ports (downstream) on the monitor.

1.5 Monitor introduction

1.5.1 Using the Controls button

Use the control button on the bottom of the monitor to adjust the image settings.

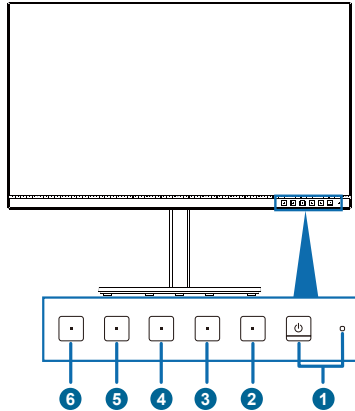

1. Power button/power indicator:
 - Turns the monitor on/off.
 - The color definition of the power indicator is as the below table.

Status	Description
White	ON
Amber	Standby mode
OFF	OFF

2. Menu button:
 - Press this button to display the OSD menu when the OSD is off.
 - Enters the OSD menu.
 - Toggles the Key Lock function between on and off with a long press for 5 seconds.
3. Close Button:
 - Press this button to display the OSD menu when the OSD is off.
 - Exit the OSD menu.
4. Input Select Button
 - Use this hotkey to switch from HDMI-1, HDMI-2, DisplayPort, USB Type-C and Enable/Disable Auto Source Detection input signal.

5.  Shortcut 1:
 - Press this button to display the OSD menu when the OSD is off.
 - Default: Brightness hotkey
 - To change the hotkey function, go to the Shortcut > Shortcut 1 menu.

6.  Shortcut 2:
 - Press this button to display the OSD menu when the OSD is off.
 - Default: Blue light filter hotkey
 - To change the hotkey function, go to the Shortcut > Shortcut 2 menu.

2.1 Adjusting the monitor

- For optimal viewing, we recommend that you look at the full face of the monitor, then adjust the monitor to the angle that is most comfortable for you.
- Hold the stand to prevent the monitor from falling when you change its angle.
- You can adjust the monitor's angle from $+35^{\circ}$ to -5° and it allows 45° swivel adjustment from either left or right.

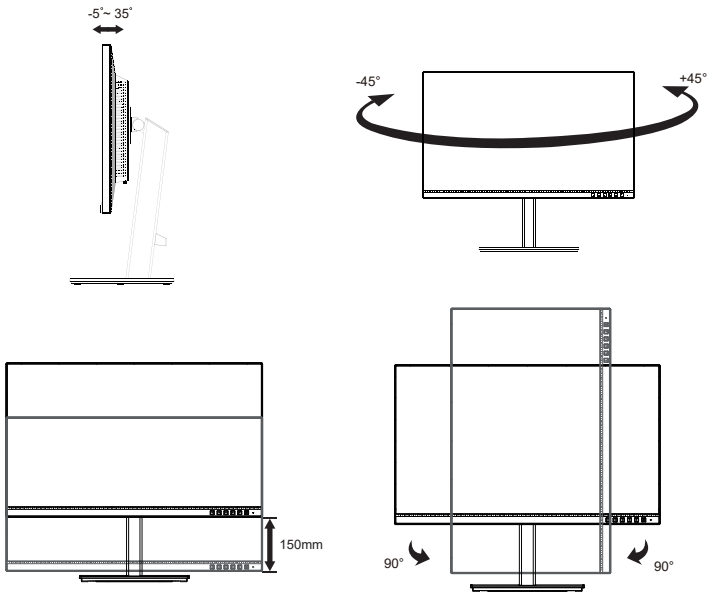

2.2 Detaching the arm/stand (for VESA wall mount)

The detachable stand of this monitor is specially designed for VESA wall mount.

To detach the arm/stand

1. Disconnect power and signal cables. Carefully put the monitor facedown on its EPS packaging.
2. Press the quick release button from rear cover.
3. Detach the stand (arm and base) from the monitor.

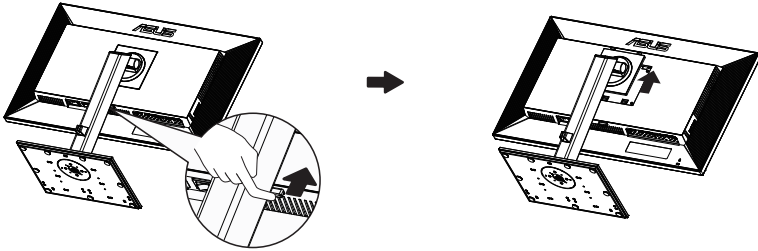

- The VESA wall mount kit (100 x 100 mm) is purchased separately.
- Use only the UL Listed Wall Mount Bracket with minimum weight/load 28.8 kg (Screw size: M4 x 10 mm).

2.3 Outline dimension



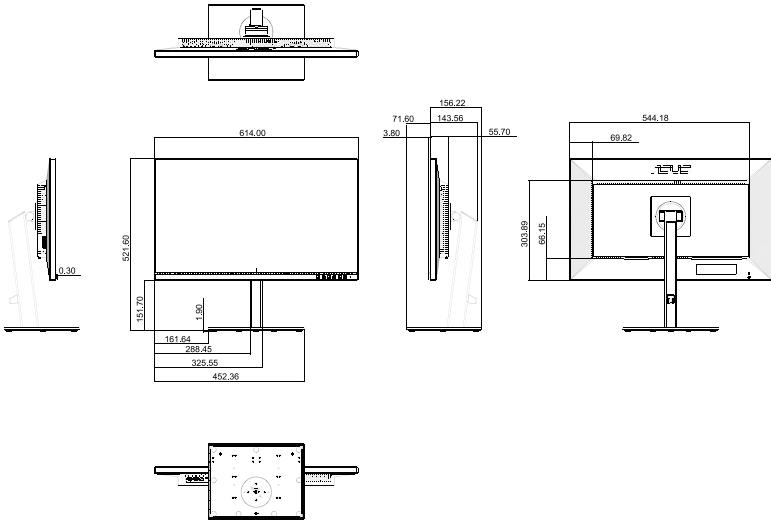



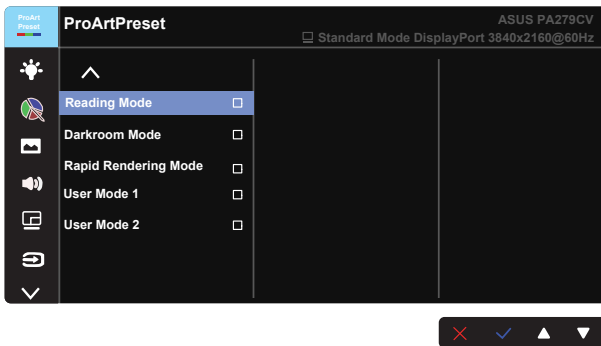
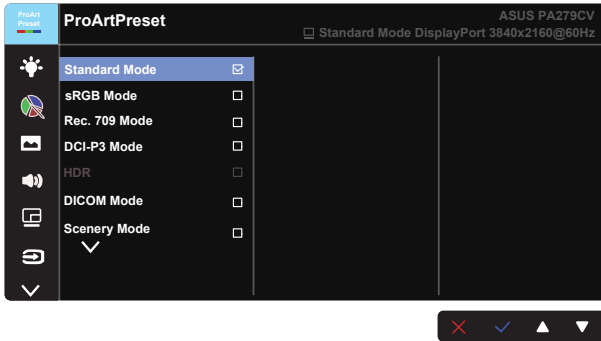

Unit: mm



3.1 OSD (On-Screen Display) menu

3.1.1 How to reconfigure



1. Press any button (except the Power button) to display the OSD menu.
2. Press the  Menu button to activate the OSD menu.
3. Press the buttons as indicated on the screen to navigate through the functions. Highlight the desired function and press  to activate it. If the function selected has a sub-menu, press  and  again to navigate through the sub-menu functions. Highlight the desired sub-menu function and press  to activate it.
4. Press  and  to change the settings of the selected function.
5. To exit and save the OSD menu, press  or  repeatedly until the OSD menu disappears. To adjust other functions, repeat steps 1-4.

3.1.2 OSD Function Introduction

1. ProArtPreset

This function contains twelve sub-functions that you can select for your preference.

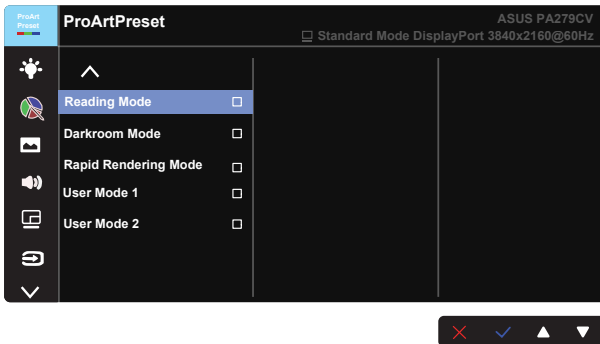
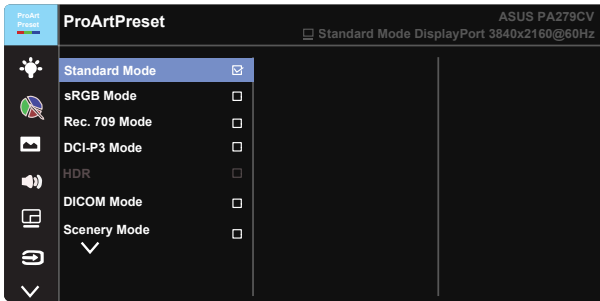

- **Standard Mode:** Best choice for document editing.
- **sRGB Mode:** Compatible with sRGB color space, sRGB mode is the best choice for document editing.
- **Rec. 709 Mode:** Compatible with Rec. 709 color space.
- **DCI-P3 Mode:** Compatible with DCI-P3 color space.
- **HDR:** High Dynamic Range. Contains three HDR modes (PQ Optimized, PQ 350, and PQ Basic).
- **DICOM Mode:** Compatible with DICOM color space.
- **Scenery Mode:** Best choice for scenery photo display.
- **Reading Mode:** This is the best choice for book reading.
- **Darkroom Mode:** This is the best choice for a weak ambient lightenvironment.

- **Rapid Rendering Mode:** Simulates display as high refresh rate performance to generate different backlight frequencies.



Rapid Rendering Mode can only be activated at 60Hz.



To activate this function, you need to do the following: turn off Adaptive-Sync. Brightness and ASCR cannot be adjusted when using this function.

- **User Mode 1:** Allows you to make color adjustments in the Advanced Setting.
- **User Mode 2:** Allows you to make color adjustments in the Advanced Setting.



- ASCR is not user-configurable in standard, sRGB, Rec.709, DCI-P3, HDR, DICOM, and Rapid Rendering Mode.
- Gamma is not user-configurable in sRGB, DCI-P3, HDR, DICOM and scenery Mode.
- Color Temp., brightness, contrast, saturation, hue, ProArt Palette/Color and black level are not user-configurable in sRGB mode.



Color Engine	Standard Mode	sRGB Mode	Rec. 709 Mode	DCI-P3 Mode	HDR	DICOM Mode	Scenery Mode	Reading Mode	Darkroom Mode	Rapid Rendering Mode	User Mode 1	User Mode 2
Color Temp.	V	NA	V	V (*1)	NA	V (*2)	V	NA	V	V	V	V
Brightness	V	NA	V	V	NA	V	V	V	V	V	V	V
Contrast	V	V	V	V	NA	V	V	V	V	V	V	V
ASCR	NA	NA	NA	NA	NA	NA	V	V	V	NA	V	V
Sharpness	V	V	V	V	V	V	V	V	V	V	V	V
Saturation	V	NA	V	V	NA	V	V	NA	V	V	V	V
Hue	V	NA	V	V	NA	V	V	NA	V	V	V	V
ProArt Palette/Color	V	NA	V	V	NA	V	V	V	V	V	NA	NA
Black Level	V	V	V	V	NA	V	V	V	V	V	NA	NA
Gamma	V	NA	V	NA	NA	NA	NA	V	V	V	V	V

V: adjustable

NA: function disabled

(*1) 6500K & P3-Theater(default) only

(*2) 6500K(default) & 9300K only

2. Blue Light Filter

Adjust the energy level of blue light emitted from LED backlight.

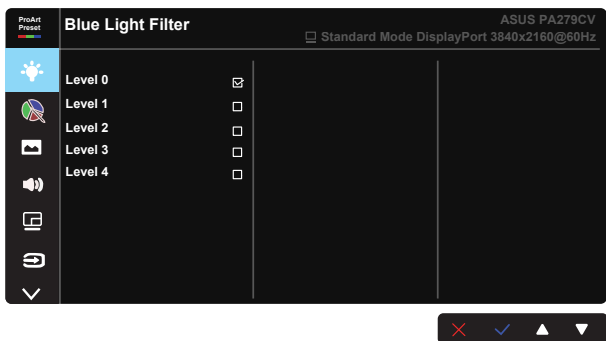

- **Level 0: No change**



-
- When Blue Light Filter is activated, the default settings of Standard Mode will be automatically imported.
 - Between Level 1 to Level 3, the Brightness function is user-configurable.
 - Level 4 is optimized setting. It is compliance with TUV Low Blue Light Certification. The Brightness function is not user-configurable.
-



Please refer to the following to alleviate eye strains:

- Users should take some time away from the display if working for long hours. It is advised to take short breaks (at least 5 mins) after around 1 hour of continuous working at the computer. Taking short and frequent breaks is more effective than a single longer break.
 - To minimize eye strain and dryness in your eyes, users should rest the eye periodically by focusing on objects that are far away.
 - Eye exercises can help to reduce eye strain. Repeat these exercises often. If eye strain continues please consult a physician. Eye exercises: (1) Repeating look up and down (2) Slowly roll your eyes (3) Move your eyes diagonal.
 - High energy blue light may lead to eye strain and AMD (Age-Related Macular Degeneration). Blue light Filter to reduce 70% (max.) harmful blue light to avoiding CVS (Computer Vision Syndrome).
-

3. ProArtPalette

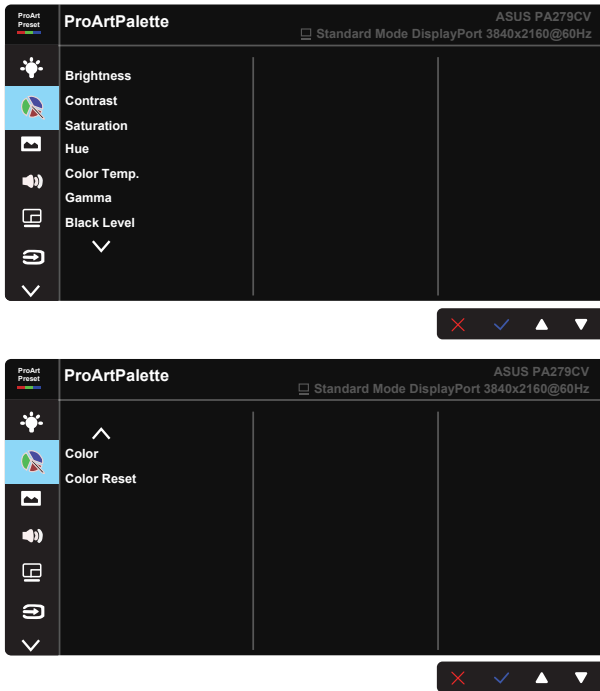

- **Brightness:** The adjusting range is from 0 to 100.
- **Contrast:** The adjusting range is from 0 to 100.
- **Saturation:** The adjusting range is from 0 to 100.
- **Hue:** Shifts the image color between green and purple
- **Color Temp.:** Contains five preset color modes 9300K, 6500K, 5500K, 5000K and P3-Theater.
- **Gamma:** Contains five gamma modes including 1.8, 2.0, 2.2, 2.4, 2.6.
- **Black Level:** To adjust the initialized 1st signal level of darkest gray level.
- **Color:**
 - * Six-axis Hue adjustment.
 - * Six-axis Saturation adjustment.
 - * Adjusts the gain levels for R, G, B.
 - * Adjusts the black level offset values for R, G, B.



P3-Theater is only available when DCI-P3 Mode is selected.

- **Color Reset:**

- * Current mode color reset:

- Resets the color settings of current color mode to the factory default value.

- * All modes color reset:

- Resets the color settings of all color modes to the factory default value.

4. Image

You can adjust Sharpness, Trace Free, Aspect Control, Input Range and ASCR from this main function.

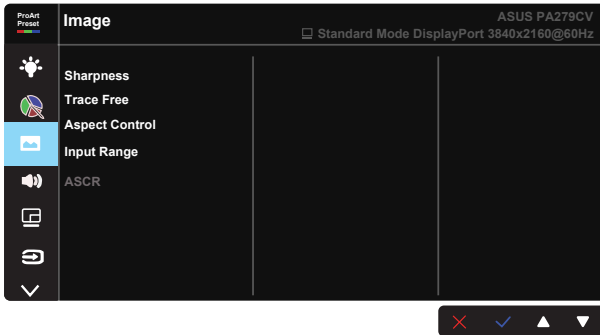

- **Sharpness:** Adjusts the picture sharpness. The adjusting range is from 0 to 100.
- **Trace Free:** Speeds up the response time by Over Drive technology. The adjusting range is from lower 0 to faster 100.
- **Aspect Control:** Adjusts the aspect ratio to Full, 4:3, 1:1, OverScan.



4:3 is only available when input source is in 4:3 format. OverScan is only available for the HDMI input source.

- **Input Range:** Adjust input range to Auto, Full and Limited 16-235.
- **ASCR:** Select ON or OFF to enable or disable dynamic contrast ratio function.

5. Sound

You can adjust Volume, Mute and Source from this main function.

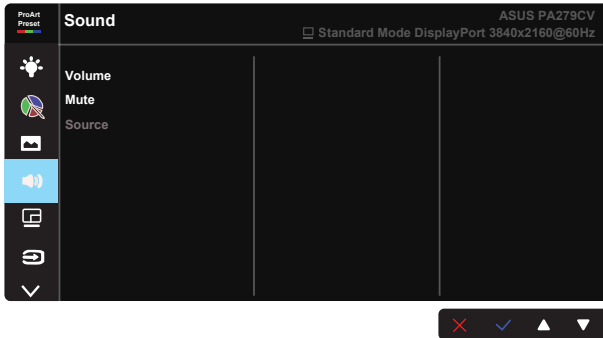

- **Volume** : Adjusts the output volume level.
- **Mute** : Select audio mute ON or OFF.
- **Source** : decides the monitor sound comes from which source.

6. PIP/PBP Setting

The PIP/PBP Setting allows you to open up sub-window(s) connected from any video source.

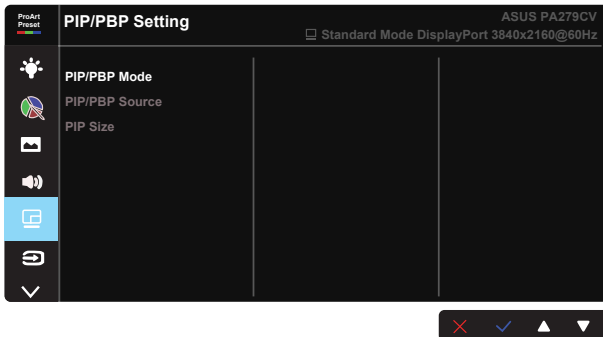

- **PIP/PBP Mode**: Select PIP, PBP or turn it off.
- **PIP/PBP Source**: Selects the video input source among, “HDMI-1”, “HDMI-2”, DisplayPort or USB Type-C.
- **PIP Size**: Adjust the PIP size to “Small”, “Middle”, or “Large”.



- Main source and sub source are available as following table.

		Sub source			
		HDMI-1	HDMI-2	DisplayPort	USB Type-C
Main Source	HDMI-1	NA	NA	OK	OK
	HDMI-2	NA	NA	OK	OK
	DisplayPort	OK	OK	NA	NA
	USB Type-C	OK	OK	NA	NA

7. Input Select

Select the input source from HDMI-1, HDMI-2, DisplayPort, USB Type-C. Enable/Disable Auto Source Detection input signal.

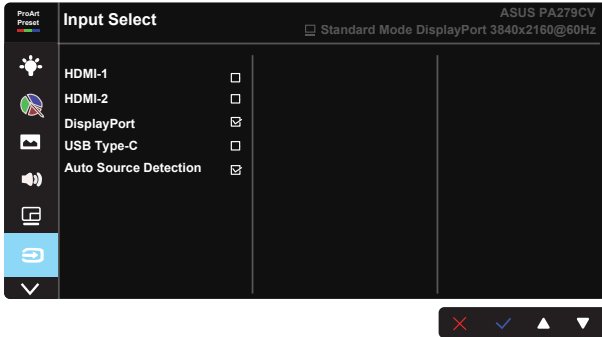

8. System Setup

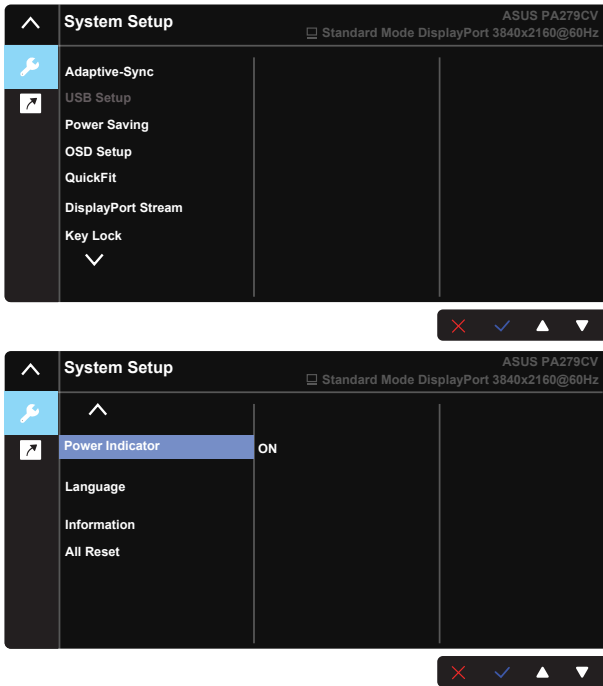

- **Adaptive-Sync:** It can allow a Adaptive-Sync supported graphics source to dynamically adjust display refresh rate based on typical content frame rates for power efficient, virtually stutter free and low-latency display update.



1. *For supported GPUs, minimum PC system and driver requirements, please contact the GPU manufactures.
2. To activate this function, you need to do the following: set DisplayPort Stream to DisplayPort 1.2, turn off Rapid Rendering Mode.

- **USB Setup:** Configures the USB Type C port setting. The USB Setup parameter affects the output resolution only when the source is connected to the USB Type C port. Due to the technological differences between USB 2.0 and USB 3.1, THE maximum USB data throughput (bandwidth and other related characteristics) varies and therefore influences the maximum output resolution.

* USB 3.1: The data transfer rate according to the 3.1 specification in USB Type C port can only output the maximum resolution of 4K2K 30Hz.

* USB 2.0: The data transfer rate according to the 2.0 specification in USB Type C port can output the maximum resolution of 4K2K 60Hz.



-
- The data transfer rate will remain USB 3.1 when using USB Type C to A cable.
 - The USB Setup setting does not affect the resolution if the source is connected to the DisplayPort or HDMI port.
-
- **Power Saving:** Select normal level for power on hub during power saving. Select Deep Level for power off hub during power saving.
 - **OSD Setup:** Adjusts the OSD Timeout, DDC/CI, and Transparency of the OSD screen.
 - **QuickFit:** Allows users to have a preview of the document or photo layout directly on screen without printing test copies.

- * **Ruler:** This pattern presents physical ruler on top and left side. You can press the ↵ Return button for longer than 3 seconds to switch the measurements between metric and imperial.



- * **Alignment:** Facilitates designers and users to organize content and layout on one page and achieve a consistent look and feel.

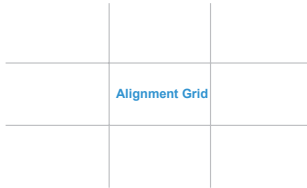

- * **A4:** Provides users to view their documents in real size on the screen.



- * **B5:** Provides users to view their documents in real size on the screen.



- **DisplayPort Stream:** Select DP 1.1 if your graphics card is not compatible with DP 1.1.
- **Key Lock:** Disable all key functions. Pressing the down button for more than five seconds to disable key lock function.
- **Power Indicator:** Turn the power LED indicator on/off.
- **language:** Select OSD language. The selections are: **English, French, German, Spanish, Italian, Dutch, , Russian, Poland, Czech, Croacia, Hungary, Romania, Portugal, Turkey, Simplified Chinese, Traditional Chinese, Japanese, Korean, Persian, Thai, Indonesian.**
- **Information:** Displays the monitor information.
- **All Reset:** Selects “Yes” to revert all settings to the factory default mode.

9. Shortcut

Selecting this option allows you to set two shortcut keys. User can select from Blue Light Filter, Brightness, Contrast, PIP/PBP Setting, Color Temp., Volume, sRGB Mode, Rec. 709 Mode, DICOM Mode, User Mode 1, User Mode 2 and set as shortcut key.

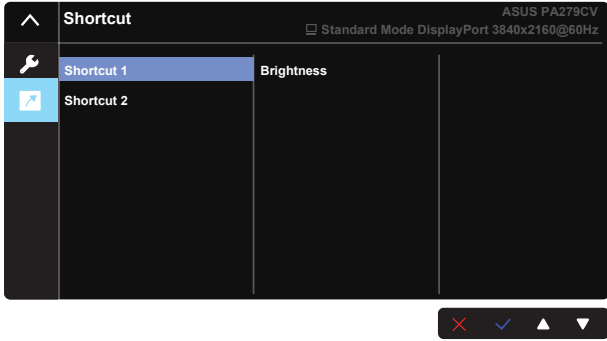

3.2 Specifications

Model	PA279CV
Panel Size	27"W (68.47cm)
Max. Resolution	3840x2160@60Hz
Brightness (Typ.)	350cd/m ²
Intrinsic Contrast Ratio (Typ.)	1000:1
Viewing Angle (CR=10)	178°(V) /178°(H)
Display Colors	1.07 B
Color Saturation	100% sRGB
Response Time	5ms (Gray to Gray)
Satellite Speaker	2W x 2 stereo
Earphone Output	Yes
Sound from HDMI	Yes
HDMI input	Yes
DisplayPort input	Yes
USB Port	Upstream x1, Downstream x 4
Power ON Consumption(Max.)	< 32 W* Based on Energy Star 8.0 standard
Chassis Colors	Black
Power saving mode	< 0.5W
Power off mode	< 0.5W
Tilt	-5° ~ +35°
Phys. Dimension (WxHxD)	614 x 523.5 x 227.82 mm(highest) 614 x 373.5 x 227.82 mm(lowest)
Phys. Dimension without stand (WxHxD) (For VESA Wall Mount)	614 x 369.9 x 59.5 mm
Box Dimension (WxHxD)	680 x 161 x 516 mm
Net Weight (Esti.)	8.6 kg(Net); 5.7 kg(without stand)
Gross Weight (Esti.)	11.2 kg
Voltage Rating	AC 100~240V(Built-in)
Operational temperature	0~40°

3.3 Troubleshooting (FAQ)

Problem	Possible Solution
Power LED is not ON	<ul style="list-style-type: none"> • Press the  button to check if the monitor is in the ON mode. • Check if the power cord is properly connected to the monitor and the power outlet. • Check Power Indicator function in main menu OSD. Select "ON" to turn on power LED.
The power LED lights amber and there is no screen image	<ul style="list-style-type: none"> • Check if the monitor and the computer are in the ON mode. • Make sure the signal cable is properly connected the monitor and the computer. • Inspect the signal cable and make sure none of the pins are bent. • Connect the computer with another available monitor to check if the computer is properly working. • Make sure Input Select setting is a valid signal. • Enable Auto Source Detection to detect all input port.
Screen image is too light or dark	<ul style="list-style-type: none"> • Adjust the Contrast and Brightness settings via OSD.
Screen image bounces or a wave pattern is present in the image	<ul style="list-style-type: none"> • Make sure the signal cable is properly connected to the monitor and the computer. • Move electrical devices that may cause electrical interference.
Screen image has color defects (white does not look white)	<ul style="list-style-type: none"> • Inspect the signal cable and make sure that none of the pins are bent. • Perform Reset via OSD. • Adjust the R/G/B color settings or select the Color Temperature via OSD.
No sound or sound is low	<ul style="list-style-type: none"> • Adjust the volume settings of both your monitor and computer. • Make sure the computer sound card driver is properly installed and activated.

3.4 Supported Timing List

PC Timings List of HDMI / DP input

Timing List	DisplayPort	HDMI1	HDMI2
640 x 480 @ 60Hz	V	V	V
800 x 600 @ 56Hz	V	V	V
800 x 600 @ 60Hz	V	V	V
1024 x 768 @ 60Hz	V	V	V
1280 x 720 @ 60Hz	V	V	V
1280 x 960 @ 60Hz	V	V	V
1280 x 1024 @ 60Hz	V	V	V
1440 x 900 @ 60Hz	V	V	V
1680 x 1050 @ 60Hz	V	V	V
1920 x 1080 @ 60Hz	V	V	V
1920 x 2160 @ 60Hz	V	V	V
2560 x 1440 @ 60Hz	V	V	V
3840 x 2160 @ 30Hz	V	V	V
3840 x 2160 @ 60Hz	V (Default)	V (Default)	V (Default)

Video timing

Timing List	DisplayPort	HDMI1	HDMI2
640x480P @ 59.94/60Hz	V	V	V
720x480P @ 59.94/60Hz	V	V	V
720x576P @ 50Hz	V	V	V
1280x720P @ 50Hz	V	V	V
1280x720P @ 59.94/60Hz	V	V	V
1440x480P @ 59.94/60Hz	V	V	V
1440x576P @ 50Hz	V	V	V
1920x1080P @ 50Hz	V	V	V
1920x1080P @ 59.94/60Hz	V	V	V
3840x2160 @ 24Hz		V	V
3840x2160 @ 25Hz		V	V
3840x2160 @ 30Hz		V	V
3840x2160 @ 50Hz	V	V	V
3840x2160 @ 60Hz	V	V	V

* The modes not listed in the above tables may not be supported. For optimal resolution, we recommend that you choose a mode listed in the above tables.