



EX Series
LCD Monitor
User Manual



Copyright

Copyright © 2018 by BenQ Corporation. All rights reserved. No part of this publication may be reproduced, transmitted, transcribed, stored in a retrieval system or translated into any language or computer language, in any form or by any means, electronic, mechanical, magnetic, optical, chemical, manual or otherwise, without the prior written permission of BenQ Corporation.

All other logos, products, or company names mentioned in this manual are the registered trademarks or copyrights of their respective owners, and are used for informational purposes only.

Disclaimer

BenQ Corporation makes no representations or warranties, either expressed or implied, with respect to the contents hereof and specifically disclaims any warranties, merchantability or fitness for any particular purpose. Further, BenQ Corporation reserves the right to revise this publication and to make changes from time to time in the contents hereof without obligation of BenQ Corporation to notify any person of such revision or changes.

The performance of flicker-free may be affected by external factors such as poor cable quality, unstable power supply, signal interference, or poor grounding, and not limited to the above mentioned external factors. (Applicable for flicker-free models only.)

BenQ ecoFACTS

BenQ has been dedicated to the design and development of greener product as part of its aspiration to realize the ideal of the "Bringing Enjoyment 'N Quality to Life" corporate vision with the ultimate goal to achieve a low-carbon society. Besides meeting international regulatory requirement and standards pertaining to environmental management, BenQ has spared no efforts in pushing our initiatives further to incorporate life cycle design in the aspects of material selection, manufacturing, packaging, transportation, using and disposal of the products. BenQ ecoFACTS label lists key eco-friendly design highlights of each product, hoping to ensure that consumers make informed green choices at purchase. Check out BenQ's CSR Website at <http://csr.BenQ.com/> for more details on BenQ's environmental commitments and achievements.



Power Safety



Please follow these safety instructions for best performance, and long life for your monitor.



- The AC plug isolates this equipment from the AC supply.
- The power supply cord serves as a power disconnect device for pluggable equipment. The socket outlet should be installed near the equipment and be easily accessible.
- This product should be operated from the type of power indicated on the marked label. If you are not sure of the type of power available, consult your dealer or local power company.
- The Class I pluggable equipment Type A must be connected to protective earth.
- An approved power cord greater or equal to H03VV-F or H05VV-F, 2G or 3G, 0.75mm² must be used.

For Germany only

- (If the weight of the product is less than or equal to 3 kg) An approved power cord greater or equal to H03VV-F, 3G, 0.75mm² must be used.
- (If the weight of the product is more than 3 kg) An approved power cord greater or equal to H05VV-F or H05RR-F, 3G, 0.75mm² must be used.
- (If a remote control is provided) RISK OF EXPLOSION IF BATTERY IS REPLACED BY AN INCORRECT TYPE. DISPOSE OF USED BATTERIES ACCORDING TO THE INSTRUCTIONS.

For models with adapter:

- Use only the power adapter supplied with your LCD Monitor. Use of another type of power adapter will result in malfunction and/or danger.
- Allow adequate ventilation around the adapter when using it to operate the device or charge the battery. Do not cover the power adapter with paper or other objects that will reduce cooling. Do not use the power adapter while it is inside a carrying case.
- Connect the power adapter to a proper power source.
- Do not attempt to service the power adapter. There are no service parts inside. Replace the unit if it is damaged or exposed to excess moisture.

Care And Cleaning

- Do not place the monitor face down on the floor or a desk surface directly. Otherwise, scratches on the panel surface may occur.

- The equipment is to be secured to the building structure before operation.
- (For models that support wall or ceiling mounting)
 - Install your monitor and monitor mounting kit on a wall with flat surface.
 - Ensure that the wall material and the standard wall mount bracket (purchased separately) are stable enough to support the weight of the monitor.
 - Turn off the monitor and the power before disconnecting the cables from the LCD monitor.
- Always unplug the product from the power outlet before cleaning. Clean the LCD monitor surface with a lint-free, non-abrasive cloth. Avoid using any liquid, aerosol or glass cleaners.
- Slots and openings on the back or top of the cabinet are for ventilation. They must not be blocked or covered. Your monitor should never be placed near or over a radiator or heat sources, or in a built-in installation unless proper ventilation is provided.
- Do not place heavy loads on the monitor to avoid possible personal injury or damage to the monitor.
- Consider keeping the box and packaging in storage for use in the future when you may need to transport the monitor.
- Refer to the product label for information on power rating, manufacture date, and identification markings.

Servicing

- Do not attempt to service this product yourself, as opening or removing covers may expose you to dangerous voltages or other risks. If any of the above mentioned misuse or other accident such as dropping or mishandling occurs, contact qualified service personnel for servicing.
- Contact your place of purchase or visit the local website from www.BenQ.com for more support.

Caution


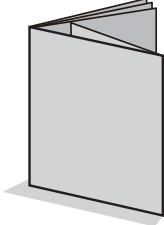

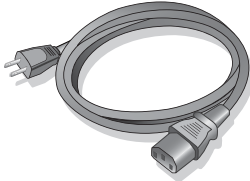
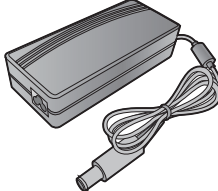
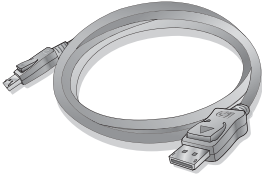
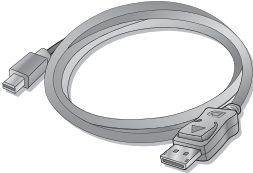
- The monitor should be 50 ~ 70 cm (20 ~ 28 inches) away from your eyes.
- Looking at the screen for an extended period of time causes eye fatigue and may deteriorate your eyesight. Rest your eyes for 5 ~ 10 minutes for every 1 hour of product use.
- Reduce your eye strain by focusing on objects far way.
- Frequent blinking and eye exercise help keep your eyes from drying out.

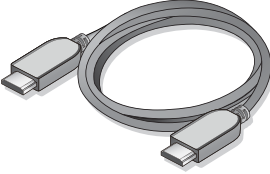
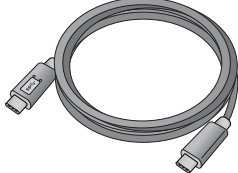
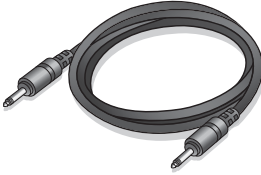

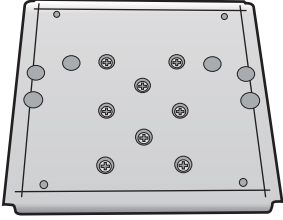
Table of Contents

Copyright	2
Getting started	6
Getting to know your monitor	8
Front view	8
Back view	8
Connections	9
How to assemble your monitor hardware	10
How to change cable connection after initial installation	15
Adjusting the monitor height	16
Using the monitor wall mount set (purchased separately)	17
Precautions	17
Getting the most from your BenQ Monitor	19
How to install the monitor driver on a new computer	20
How to upgrade the monitor driver on an existing computer	21
How to install driver on Windows 10 system	22
How to install driver on Windows 8 (8.1) system	23
How to install driver on Windows 7 system	24
How to adjust your monitor	25
The control panel.....	25
Basic menu operation	26
Customizing the hot keys.....	27
Working with HDR technology.....	27
Adjusting display mode.....	28
Choosing an appropriate picture mode.....	28
Connecting the monitor to your MacBook series product	29
Video source selection in PIP/PBP mode.....	29
Activating FreeSync.....	29
Navigating the main menu	31
Display menu	32
Picture menu	34
Picture Advanced menu	36
Audio menu	39
System menu	40
Troubleshooting	44
Frequently asked questions (FAQ).....	44
Need more help?.....	46

Getting started

When unpacking please check you have the following items. If any are missing or damaged, please contact the place of purchase for a replacement.

BenQ LCD Monitor	
Quick Start Guide	
CD-ROM	
Power Cord (Picture may differ from product supplied for your region.)	
Power Adapter	
Video Cable: DP (Optional accessory)	
Video Cable: DP to mini DP	

Video Cable: HDMI	
USB Cable: USB-C™	
Audio Cable (Optional accessory)	
Back Cover	
VESA Wall Mount Transfer Kit (Optional accessory)	



• Available accessories and the pictures shown here may differ from the actual contents and the product supplied for your region. And the package contents may subject to change without prior notice. For cables that are not supplied with your product, you can purchase them separately.

• Consider keeping the box and packaging in storage for use in the future when you may need to transport the monitor. The fitted foam packing is ideal for protecting the monitor during transport.



Always keep the product and accessories out of reach of small children.

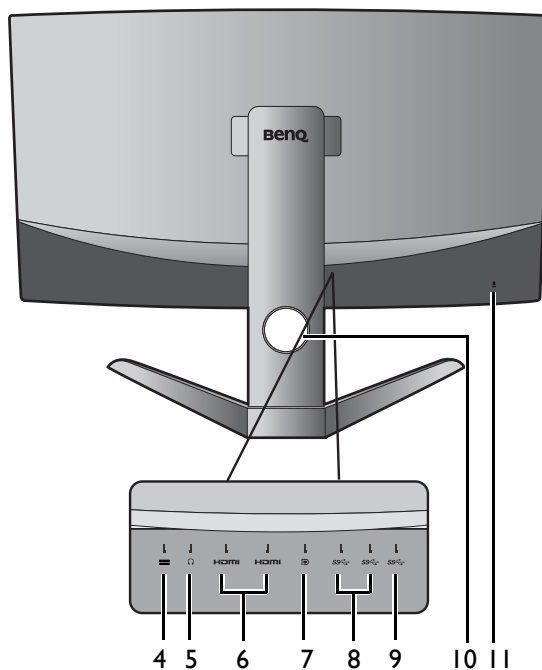
Getting to know your monitor

Front view



1. Light sensor
2. Power button / Power LED indicator
3. Control buttons

Back view



4. DC power input jack
5. Headphone jack
6. HDMI sockets
7. DisplayPort socket
8. USB 3.0 ports
9. USB-C™ port (*)
10. Cable management hole
11. Kensington lock slot



• Above diagram may vary depending on the model.

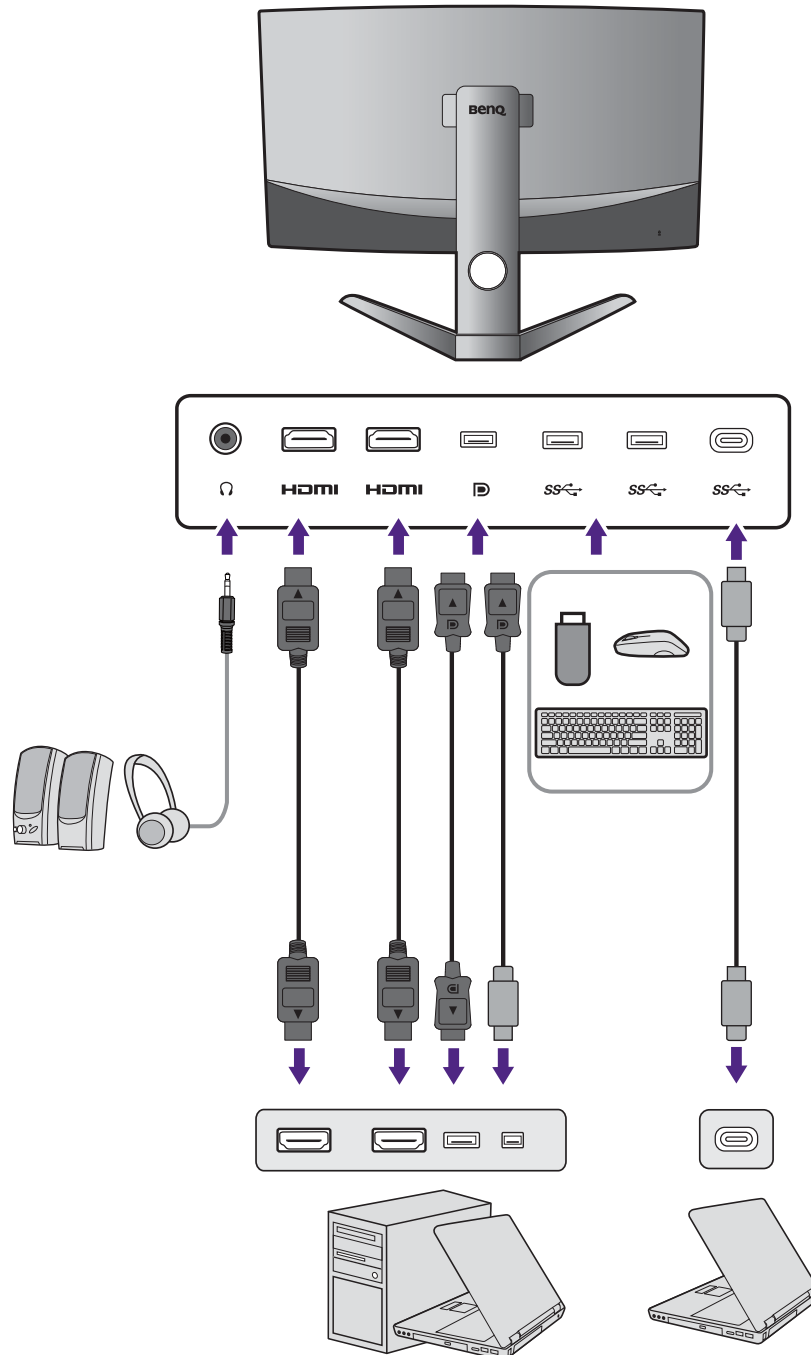
• Picture may differ from product supplied for your region.

• *: 1) USB 3.1 with up to 5Gbps data transmission speed; 2) supports up to 2560 x 1440; 3) power delivery up to 5V@1A, 5W.

Connections

The following connection illustrations are for your reference only. For cables that are not supplied with your product, you can purchase them separately.

For detailed connection methods, see page 11.



- If USB-C™ Alternate mode (DP Alt mode) is enabled, USB 2.0 is available from the USB downstream ports.
- If the video input is via HDMI or DP and USB-C™ works as upstream port, USB 3.1 Gen 1 (5 Gb/s) is available from the USB downstream ports.

How to assemble your monitor hardware



- If the computer is turned on, you must turn it off before continuing.
Do not plug-in or turn-on the power to the monitor until instructed to do so.
- The following illustrations are for your reference only. The location and available input and output jacks may vary depending on the purchased model.
- The supported timing may vary by input signal. Refer to the "Preset display modes" section on the link "Adjusting the Screen Resolution" on the CD for more information.
- Avoid finger pressure on the screen surface.



Be careful when handling the sharp monitor base and protect yourself from any physical harm.

1. Attach the monitor base.

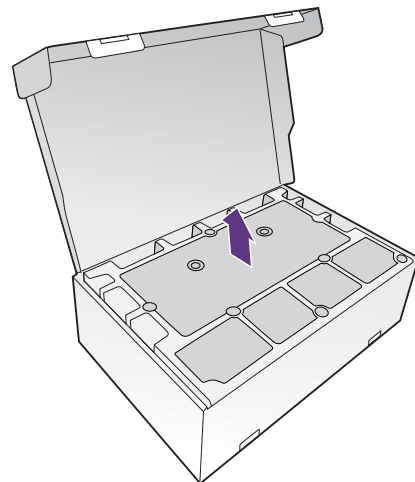


Your monitor comes with a curved screen and the screen surface should never be placed on the desk without a cushion underneath.



Please be careful to prevent damage to the monitor. Placing the screen surface on an object like a stapler or a mouse will crack the glass or damage the LCD substrate voiding your warranty. Sliding or scraping the monitor around on your desk will scratch or damage the monitor surround and controls.

Open the box, and remove the cushion that protects the back of the monitor.



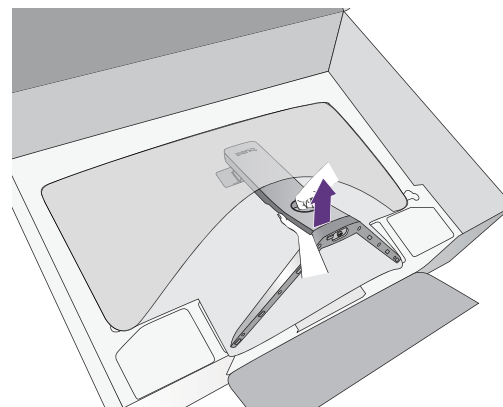
2. Lift the monitor.

Take the monitor out of the box by holding the stand arm. Carefully lift the monitor, turn it over and place it upright on its stand on a flat even surface.

Remove the foam wrap from the monitor.



Consider keeping the box and packaging in storage for use in the future when you may need to transport the monitor. The fitted foam packing is ideal for protecting the monitor during transport.

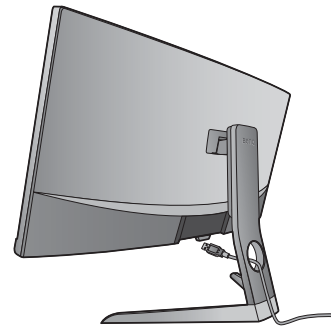


3. Connect the PC video cable.

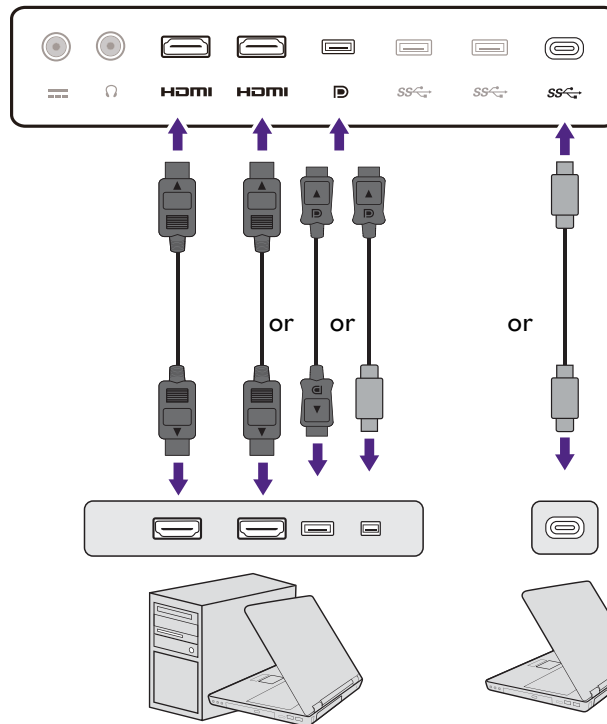


The video cables included in your package and the socket illustrations may vary depending on the product supplied for your region.

1. Pass the cable through the cable management hole on the stand arm.



2. Establish a video cable connection.



- Connect the plug of the HDMI cable to the HDMI port on the monitor.
- Connect the plug of the DP cable to the monitor video socket.



After the monitor and the computer are powered on, if the image is not displayed, disconnect the DP cable. Connect the monitor to any video source other than DP first. Go to **System and DisplayPort** on the OSD menu of the monitor and change the setting from **1.4** to **1.1**. Once the setting is done, unplug the current video cable and re-connect the DP cable. To go to the OSD menu, see [Basic menu operation on page 26](#).

- Connect the plug of the supplied USB-C™ cable to the USB-C™ port on the monitor. It allows signal, audio, and data transmission from the laptop to the monitor.



The USB-C™ port on the monitor transfers data only and does not support power delivery to the laptop. Additional power supply to the connected laptop is required.



Due to USB-C™ technology limitation, the USB transmission speed is determined only by the selected refresh rate. See [USB-C Configuration on page 42](#) and [Options for data transfer via USB-C™ on page 43](#) for more information.

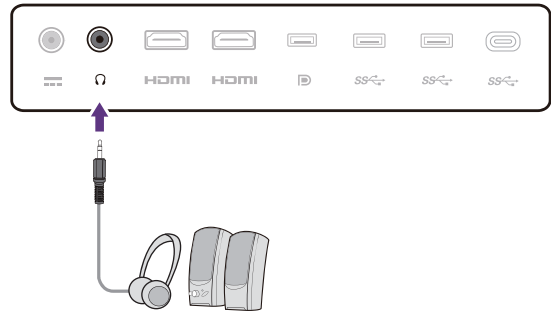
3. Tighten all finger screws to prevent the plugs from accidentally falling out during use.

4. Connect the other end of the video cable to an appropriate port of a digital output source (e.g., a computer).

5. Connect the headphone.

Pass the cable through the cable management hole on the stand arm first.

You may connect headphones to the headphone jack found on the back side of the monitor.

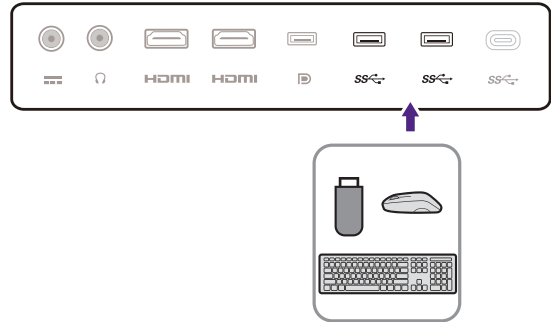


6. Connect USB devices.


Connect USB devices via other USB ports (downstream) on the monitor. These downstream USB ports transmit data between connected USB devices and the upstream port (USB-C™).

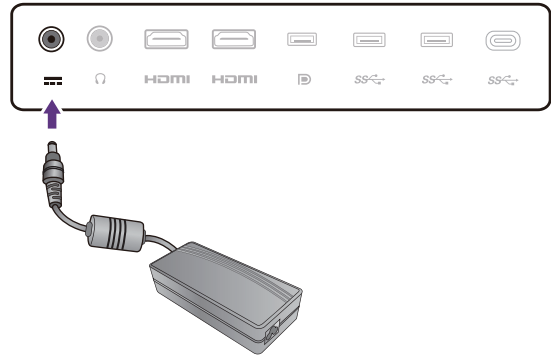


The USB hubs (downstream ports) are available only when the USB-C™ port is in use.



7. Connect the power adapter to the monitor.

Pass the cable through the cable management hole on the stand arm first. Connect the power adapter to the socket labelled  on the rear of the monitor. Do not connect the other end to a power outlet just yet.

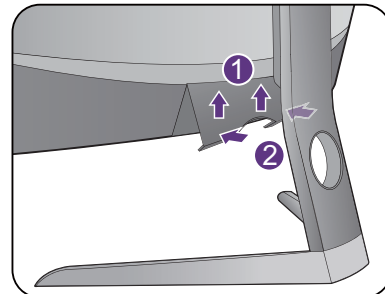


8. Install the back cover.

Align the back cover with the holes on the back of the monitor (1), and press the sides and the bottom of the back cover against the holes to lock it into place as illustrated (2). Push from the bottom of the cover and check if the it has been installed properly.



To remove the back cover, see [How to change cable connection after initial installation on page 15](#) for more information.

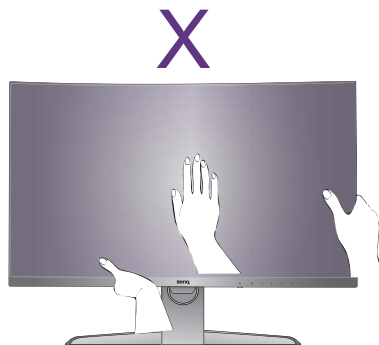


9. Place the monitor properly.

Place the monitor as desired after the cables have been connected properly. Move the monitor carefully by holding lower part of monitor, the base or the stand arm.



Finger pressure on the screen surface is prohibited. The screen may be damaged by excessive force.



10. Tilt the monitor.

You should position the monitor and angle the screen to minimize unwanted reflections from other light sources.

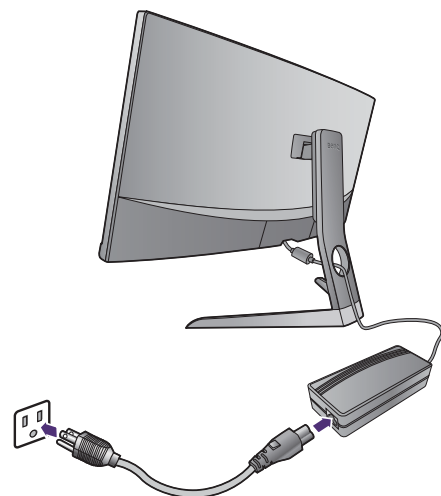
- ! Your monitor is an edge-to-edge monitor, handle it with care. Avoid finger pressure on the screen surface. Adjust the screen angle by placing your hands on the top and on the bottom of the monitor as illustrated. Excessive force on the display is prohibited.



11. Connect-to and turn-on the power.

Connect the power cord to the power adapter. Plug the other end of the power cord into a power outlet and turn it on.

- ✎ Picture may differ from product supplied for your region.

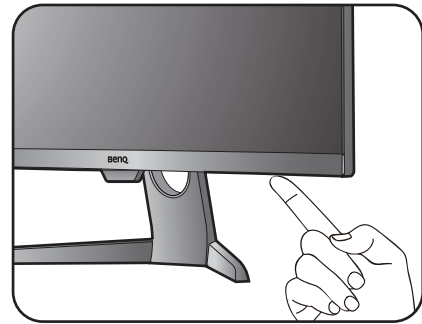


Turn on the monitor by pressing the power button on the monitor.

Turn on the computer too, and follow the instructions in [Getting the most from your BenQ Monitor on page 19](#) to install the monitor software.



To extend the service life of the product, we recommend that you use your computer's power management function.



How to change cable connection after initial installation

To protect the curved screen, do not lay the screen face down on the desk without the protection of the supplied cushion. If you prefer to change the cable connection after the initial installation has been completed in [How to assemble your monitor hardware on page 10](#), follow the procedures below.

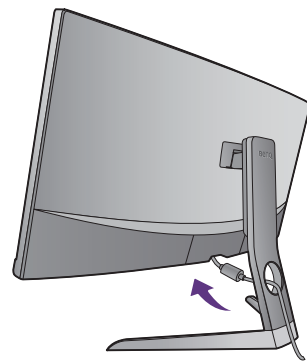
1. Turn off the monitor.

Turn off the monitor and the power before unplugging the power cable. Turn off the computer before unplugging the monitor signal cable.



2. Tilt the monitor to its extended position.

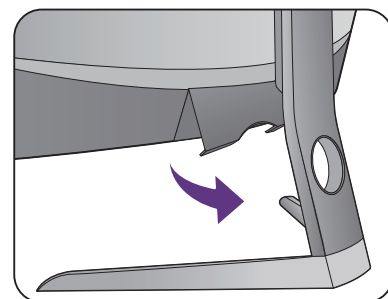
Gently tilt the monitor to the maximum extended position. To properly tilt the monitor, see [Tilt the monitor. on page 13](#).



3. Remove the back cover.

Remove the back cover from its bottom as illustrated.

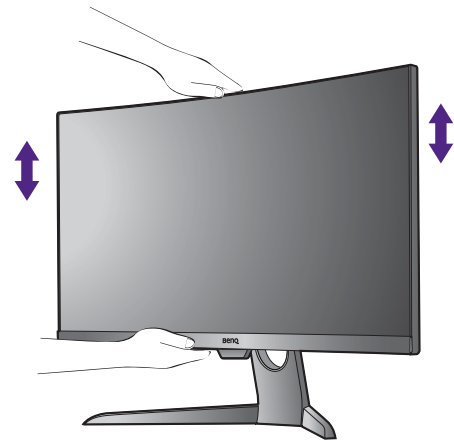
Follow the instructions in [Establish a video cable connection. on page 11](#) and change connected cables. Re-install the back cover as instructed in [Install the back cover. on page 12](#).



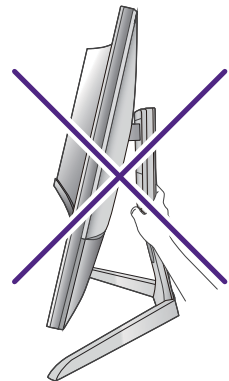
Adjusting the monitor height

To adjust the monitor height, hold both the left and the right sides of the monitor to lower the monitor or lift it up to the desired height.

- ! Avoid finger pressure on the screen surface. Excessive force on the display is prohibited.



- ! Avoid placing hands on the upper or lower part of the height-adjustable stand or at the bottom of the monitor, as ascending or descending monitor might cause personal injuries. Keep children out of reach of the monitor while performing this operation.



Using the monitor wall mount set (purchased separately)

The back of your monitor has screw holes to fix the stand and the base. A VESA standard mount bracket with 100mm pattern could be installed via installing a special transfer kit made for this model. Should you need the VESA wall mount transfer kit, please contact BenQ service.

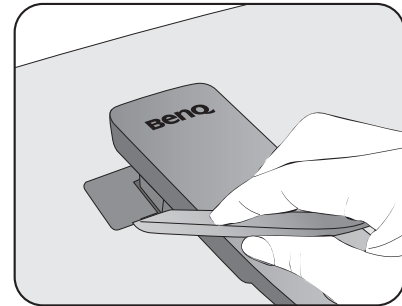
Before starting to install the monitor wall mount set, please read the precautions carefully.

Precautions

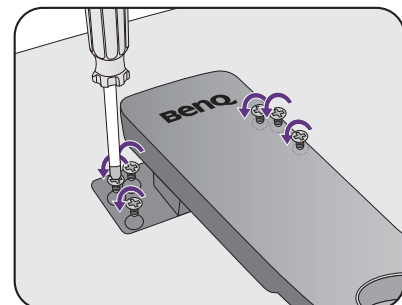
- Install your monitor and monitor mount set on a wall with flat surface.
- Ensure that the wall material and the standard wall mount set (purchased separately) are stable enough to support the weight of the monitor. Refer to the product specifications for weight information.
- Turn off the monitor and the power before disconnecting the cables from the LCD monitor.

I. Remove the monitor stand and base.

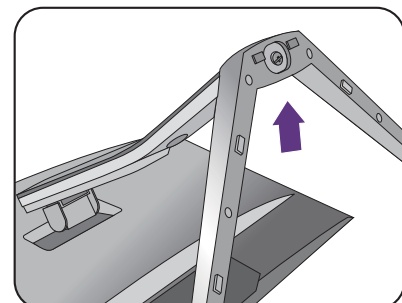
While the monitor is inside the box, remove the stand hinge cover with a opening pry tool (purchased separately).



Release the screws fixing the stand to the monitor.

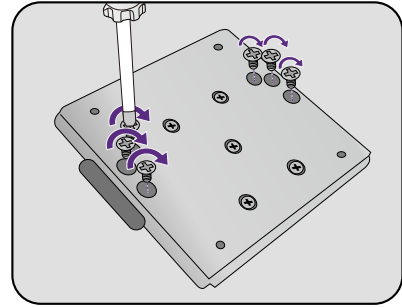


Lift the end of the stand arm up to remove it from the monitor.



2. Install the VESA wall mount transfer kit as illustrated.

Use a magnetic tip screwdriver to fix the VESA wall mount transfer kit to the monitor with 6 screws from step 1.



3. Follow the instruction manuals of the wall mount bracket you purchased to complete the installation.



Use four M4 x 10 mm screws to fix a VESA standard wall mount bracket to the monitor. Make sure that all screws are tightened and secured properly. Consult a professional technician or BenQ service for wall mount installation and safety precautions.

Getting the most from your BenQ Monitor

To gain the most benefit from your new BenQ LCD Monitor, you should install the custom BenQ LCD Monitor driver software as provided on the BenQ LCD Monitor CD-ROM.

The circumstances under which you connect and install your BenQ LCD Monitor will determine which process you need to follow to successfully install the BenQ LCD Monitor driver software. These circumstances relate to which version of Microsoft Windows you are using, and whether you are connecting the monitor and installing the software onto a new computer (without existing monitor driver software), or whether you are upgrading an existing installation (which already has existing monitor driver software) with a newer monitor.

In either case however, the very next time you turn on your computer (after connecting the monitor to your computer), Windows will automatically recognize the new (or different) hardware, and will launch its **Found New Hardware wizard**.

Follow the wizard instructions until it asks you to select a monitor model. At that point, click the **Have Disk** button, insert the BenQ LCD Monitor CD-ROM and select the appropriate monitor model. Further details and step-by-step instructions for either an automatic (new) or upgrade (existing) installation, see:

- [How to install the monitor driver on a new computer on page 20.](#)
- [How to upgrade the monitor driver on an existing computer on page 21.](#)



- If you require a User Name and Password to login to your Windows computer, you must be logged on as an Administrator or as a member of the Administrators group in order to install the monitor driver software. Furthermore, if your computer is connected to a network which has security access requirements, network policy settings may prevent you from installing software on your computer.
 - To check the name of the purchased model, refer to the specification label on the back of the monitor.
-

How to install the monitor driver on a new computer

This instruction details the procedure for selecting and installing the BenQ LCD Monitor driver software on a new computer which has never had a monitor driver installed before. This instruction is only suitable for a computer which has never been used before, and for which the BenQ LCD Monitor is the first ever monitor to be connected to it.



If you are adding the BenQ LCD Monitor to an existing computer that has already had another monitor connected to it (and has monitor driver software installed), you should not be following these instructions. You should instead be following the instructions for [How to upgrade the monitor driver on an existing computer](#).

1. Follow the instructions in [How to assemble your monitor hardware on page 10](#).
When Windows starts, it will automatically detect the new monitor and launch the **Found New Hardware Wizard**. Follow the prompts until it displays the option to **Install Hardware Device Drivers**.
2. Insert the BenQ LCD Monitor CD-ROM into a CD drive on the computer.
3. Check **Search for a suitable driver for my device** option, and click **Next**.
4. Check the option for CD-ROM drives (uncheck all others) and click **Next**.
5. Look to confirm that the wizard has selected the correct name of your monitor and click **Next**.
6. Click **Finish**.
7. Restart the computer.

How to upgrade the monitor driver on an existing computer

This instruction details the procedure for manually updating the existing monitor driver software on your Microsoft Windows computer. It is currently tested as compatible for Windows 10, Windows 8 (8.1), and Windows 7 Operating System (OS).



The BenQ LCD Monitor driver for your model may well function perfectly with other versions of Windows, however, as at the time of writing, BenQ has done no testing of this driver on other versions of Windows and cannot guarantee its operation on those systems.

Installing monitor driver software involves selecting an appropriate information file (.inf) on the BenQ LCD Monitor CD-ROM for the particular model monitor you have connected, and letting Windows install the corresponding driver files from the CD. You need only steer it in the right direction. Windows has an Upgrade Device Driver Wizard to automate the task and guide you through the file selection and installation process.

See:

- [How to install driver on Windows 10 system on page 22.](#)
- [How to install driver on Windows 8 \(8.1\) system on page 23.](#)
- [How to install driver on Windows 7 system on page 24.](#)

How to install driver on Windows 10 system

1. Open **Display Properties**.

Go to **Start, Settings, Devices, Devices and Printers** and right-click the name of your monitor from the menu.

2. Select **Properties** from the menu.

3. Click the **Hardware** tab.

4. Click **Generic PnP Monitor**, and then the **Properties** button.

5. Click the **Driver** tab and the **Update Driver** button.

6. Insert the BenQ LCD Monitor CD-ROM into a CD drive on the computer.

7. In the **Update Driver Software** window, select the option **Browse my computer for driver software**.

8. Click **Browse** and navigate to the following directory: d:\BenQ_LCD\Driver\ (where d is the drive letter designator for the CD-ROM drive).



The drive letter for your CD drive may differ from the example above depending upon your system - it may be 'D:' or 'E:' or 'F:' etc.

9. Select the correct folder name of your monitor from provided driver list, and click **Next**.

This will copy and install the appropriate monitor driver files to your computer.

10. Click **Close**.

You may be prompted to restart your computer after the driver update is complete.

How to install driver on Windows 8 (8.1) system

1. Open **Display Properties**.

Move the cursor to the lower-right of the screen or press the **Windows + C** buttons on the keyboard to bring up the **Charm** bar. Go to **Settings, Control Panel, Devices and Printers** and right-click the name of your monitor from the menu.

Alternatively, right-click the desktop and select **Personalize, Display, Devices and Printers**, and right-click the name of your monitor from the menu.

2. Select **Properties** from the menu.

3. Click the **Hardware** tab.

4. Click **Generic PnP Monitor**, and then the **Properties** button.

5. Click the **Driver** tab and the **Update Driver** button.

6. Insert the BenQ LCD Monitor CD-ROM into a CD drive on the computer.

7. In the **Update Driver Software** window, select the option **Browse my computer for driver software**.

8. Click **Browse** and navigate to the following directory: d:\BenQ_LCD\Driver\ (where d is the drive letter designator for the CD-ROM drive).



The drive letter for your CD drive may differ from the example above depending upon your system - it may be 'D:' or 'E:' or 'F:' etc.

9. Select the correct folder name of your monitor from provided driver list, and click **Next**.

This will copy and install the appropriate monitor driver files to your computer.

10. Click **Close**.

You may be prompted to restart your computer after the driver update is complete.

How to install driver on Windows 7 system

1. Open **Display Properties**.

Go to **Start, Control Panel, Hardware and Sound, Devices and Printers** and right-click the name of your monitor from the menu.

Alternatively, right-click the desktop and select **Personalize, Display, Devices and Printers**, and right-click the name of your monitor from the menu.

2. Select **Properties** from the menu.

3. Click the **Hardware** tab.

4. Click **Generic PnP Monitor**, and then the **Properties** button.

5. Click the **Driver** tab and the **Update Driver** button.

6. Insert the BenQ LCD Monitor CD-ROM into a CD drive on the computer.

7. In the **Update Driver Software** window, select the option **Browse my computer for driver software**.

8. Click **Browse** and navigate to the following directory: d:\BenQ_LCD\Driver\ (where d is the drive letter designator for the CD-ROM drive).



The drive letter for your CD drive may differ from the example above depending upon your system - it may be 'D:' or 'E:' or 'F:' etc.

9. Select the correct folder name of your monitor from provided driver list, and click **Next**.

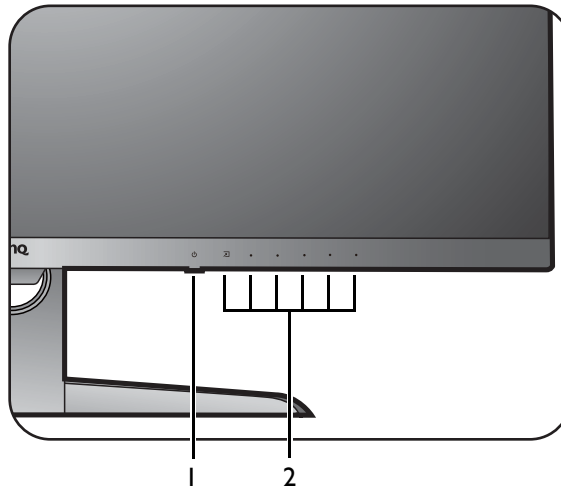
This will copy and install the appropriate monitor driver files to your computer.

10. Click **Close**.

You may be prompted to restart your computer after the driver update is complete.

How to adjust your monitor

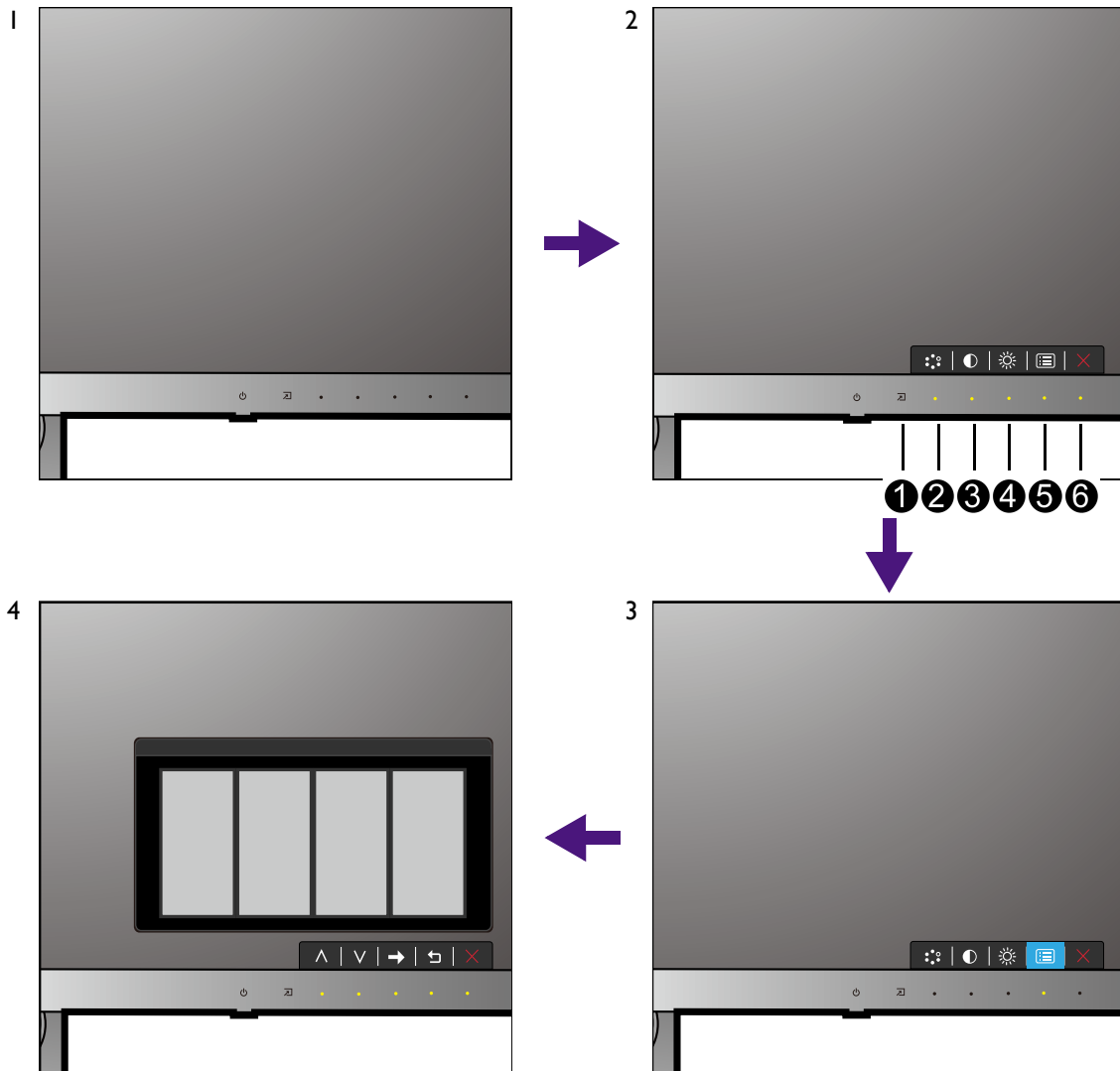
The control panel




No.	Name	Description
1.	Power key	Turns the power on or off.
2.	Control keys	Accesses the functions or menu items displayed on the screen, right next to each key.

Basic menu operation

All OSD (On Screen Display) menus can be accessed by the control keys. You can use the OSD menu to adjust all the settings on your monitor.



1. Press any of the control keys.
2. The hot key menu is displayed. The keys numbered ②, ③, and ④ are custom keys and are designated for particular functions.
3. Select  (**Menu**) to access the main menu.
4. In the main menu, follow the icons next to the control keys to make adjustments or selection. See [Navigating the main menu on page 31](#) for details on the menu options.

No.	OSD in hot key menu	OSD icon in main menu	Function
①	Input hot key		The key is the hot key for Input .


No.	OSD in hot key menu	OSD icon in main menu	Function
②	Custom Key 1	^	<ul style="list-style-type: none"> • By default, the key is the hot key for Picture Mode. To change the default settings, see Customizing the hot keys on page 27. • For Up/Increase adjustment.
③	Custom Key 2	v	<ul style="list-style-type: none"> • By default, the key is the hot key for Contrast. To change the default settings, see Customizing the hot keys on page 27. • For Down/Decrease adjustment.
④	Custom Key 3	→ / OK	<ul style="list-style-type: none"> • By default, the key is the hot key for Brightness. To change the default settings, see Customizing the hot keys on page 27. • Enters sub menus. • Selects menu items.
⑤	Menu	↶	<ul style="list-style-type: none"> • Activates the main menu. • Returns to the previous menu.
⑥	Exit	✕	Exits OSD menu.



- OSD = On Screen Display.
The hot keys only operate while the main menu is not currently displaying. Hot key displays will disappear after a few seconds of no key activity.
- To unlock the OSD controls, press and hold any key for 10 seconds.

Customizing the hot keys

The custom keys (see [page 26](#)) perform as hot keys to provide direct access to pre-defined functions. You can change the default setting and designate different functions for these keys.

1. Press any of the control keys to bring up the hot key menu. Select  (**Menu**) to access the main menu.
2. Go to **System**.
3. Select the custom key you want to change.
4. In the sub menu, select a function that can be accessed by this key. A pop-up message will appear, showing that the setup is complete.

Working with HDR technology



- Your monitor supports HDR10 content.
- The information regarding HDR-compatible devices and content in this document is most up-to-date at the time of publication. For the latest information, contact your device manufacturer and content provider.


To enable HDR function, you need to have a compatible player and content.

1. Make sure a 4K HDR player is ready. Players with the following names and resolutions are supported.

Commonly used names for 4K (may vary by manufacturer)	4K, 4K Ultra HD, UHD, UHD 4K, Ultra HD, 2160p
Supported resolution or modes	2560 x 1440 @ 24 Hz, 50 Hz, or 60 Hz
Commonly used names for HDR10 (may vary by manufacturer)	HDR Premium, High Dynamic Range, HDR, Ultra HD Premium

2. Make sure HDR content is available. Content may come from 4K UHD (Blue-Ray) or new HDR games on Xbox One S and PS4 Pro.
3. Make sure the player and the monitor have been connected via an appropriate cable:
 - the provided HDMI / DP / DP to mini DP cable / USB-C™ cable (if available)
 - an HDMI cable that is HDMI High Speed or HDMI Premium certified
 - a DP / DP to mini DP cable that is DisplayPort compliance certified
 - a certified USB-C™ cable

Enabling HDR function


1. Press any of the control keys to bring up the hot key menu. Select  (**Menu**) to access the main menu.
2. Go to **Picture Advanced** and **Picture Mode**.
3. Select **HDR** or **Cinema HDR**. An OSD message displays.
 - **HDR: On:** This means your content player and content are HDR-compatible and the HDR function is properly enabled. The monitor is following the ST2084 standard to process the HDR content. In this case, **HDR** and **Cinema HDR** are available under **Picture Advanced > Picture Mode**.
 - **HDR: Emulated:** This means the input content is not HDR-compatible and the monitor is in HDR-emulated mode. In this case, all **Picture Mode** options except **HDR** and **Cinema HDR** are available. Refer [Working with HDR technology on page 27](#) to check if a supported player, content, and the certified cable are used.



If the OSD message is **FreeSync2 HDR: ON**, this means the input content from the PC games are HDR-enabled. All the options under **Picture Mode** are not available in this case.

Adjusting display mode

To display images of aspect ratio other than 16:9 and size other than the panel size of your purchased model, you can adjust the display mode on the monitor.

1. Press any of the control keys to bring up the hot key menu. Select  (**Menu**) to access the main menu.
2. Go to **Picture Advanced** and **Display Mode**.
3. Select an appropriate display mode. The setting will take effect immediately.

Choosing an appropriate picture mode

Your monitor provides various picture modes that are suitable for different types of images. See [Picture Mode on page 36](#) for all the available picture modes.

Go to **Picture Advanced** and **Picture Mode** for a desired picture mode.

Connecting the monitor to your MacBook series product

While the monitor is connected to your MacBook series product, switch to **M-book** mode which represents MacBook's color matching and visual representation on your monitor.

1. Connect your monitor to the MacBook series product.
2. Go to **Picture Advanced** and **Picture Mode**.
3. Select **M-book**. The setting will take effect immediately.

Video source selection in PIP/PBP mode

Your monitor scans for the available video sources in the following order: HDMI, DP, and USB-C™, and displays the first available one. This video source will become the main source in PIP/PBP mode. You will need to decide the second source for PIP/PBP mode from the menu in [PIP/PBP source on page 33](#). Menu options that are not available will become grayed out.

Refer to the following table to find your main source and its supporting second sources. To find out the supported incoming display mode (input timing), please read the "**Preset display modes**" section from the link "**Adjusting the Screen Resolution**" on the CD.

		Possible second sources				
		Inputs	HDMI-1	HDMI-2	DP	USB-C™
Main source	HDMI-1			✓	✓	✓
	HDMI-2		✓		✓	✓
	DP		✓	✓		✓
	USB-C™		✓	✓	✓	

Activating FreeSync

Monitors featuring with the VESA standard FreeSync will eliminate screen tearing, stuttering, and juddering during gaming.

1. Turn on the FreeSync function from the operating system of your computer. The procedures may vary depending on the operating system.
2. Use a compatible graphics processing units (GPU) with the forthcoming driver. Confirm supported technologies please visit www.AMD.com.
3. Ensure to connect with DisplayPort or HDMI. See [Connect the PC video cable. on page 11](#) for more information.
4. Go to **System** and **FreeSync** on the OSD menu of the monitor, and select an appropriate option.
 - **Normal**: The basic FreeSync function is enabled.

- **Premium:** The enhanced FreeSync function is enabled and the screen refresh rate is increased.
-




If you encounter screen flickering in the **Premium** mode during gaming or video playback, try with the following.

- Decrease the game setting values.
- Visit www.AMD.com and make sure the most up-to-date driver has been installed.
- Change to the **Normal** mode of FreeSync instead.

If the response rate changes constantly, select a lower resolution.

Navigating the main menu

You can use the OSD (On Screen Display) menu to adjust all the settings on your monitor.

Press any of the control keys to bring up the hot key menu. Select  (**Menu**) to access the main menu. See [Basic menu operation on page 26](#) for details.

Available menu options may vary depending on the input sources, functions and settings. Menu options that are not available will become grayed out. Keys that are not available will be disabled and the corresponding OSD icons will disappear. For models without certain functions, their settings and related items will not appear on the menu.



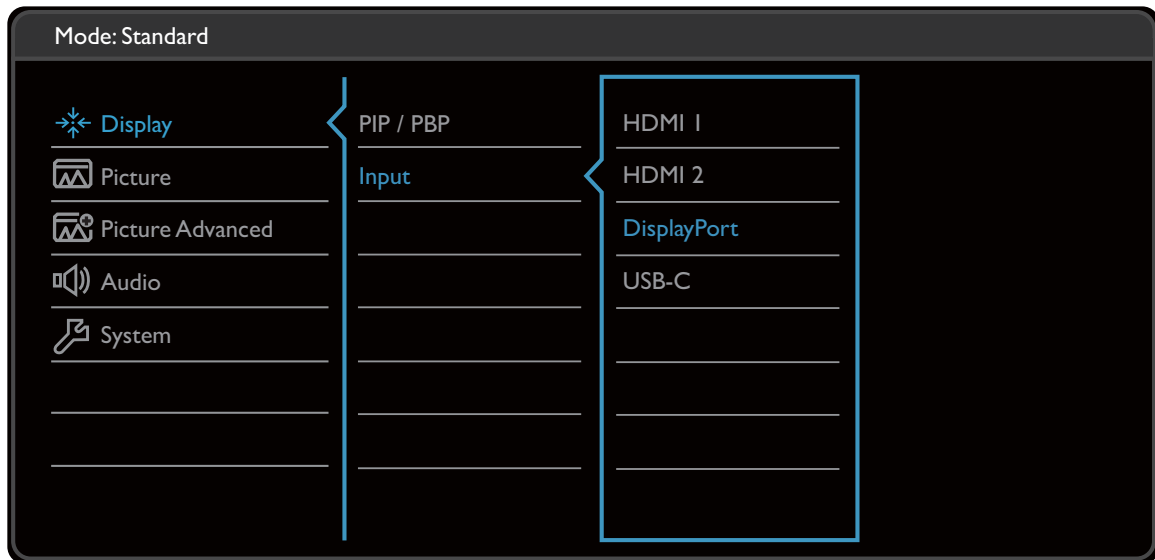
The OSD menu languages may differ from the product supplied to your region, see [Language on page 41](#) under **System** and **OSD Settings** for more details.











For more information on each menu, please refer to the following pages:


- [Display menu on page 32](#)
- [Picture menu on page 34](#)
- [Picture Advanced menu on page 36](#)
- [Audio menu on page 39](#)
- [System menu on page 40](#)

Display menu

Available menu options may vary depending on the input sources, functions and settings. Menu options that are not available will become grayed out. Keys that are not available will be disabled and the corresponding OSD icons will disappear. For models without certain functions, their settings and related items will not appear on the menu.



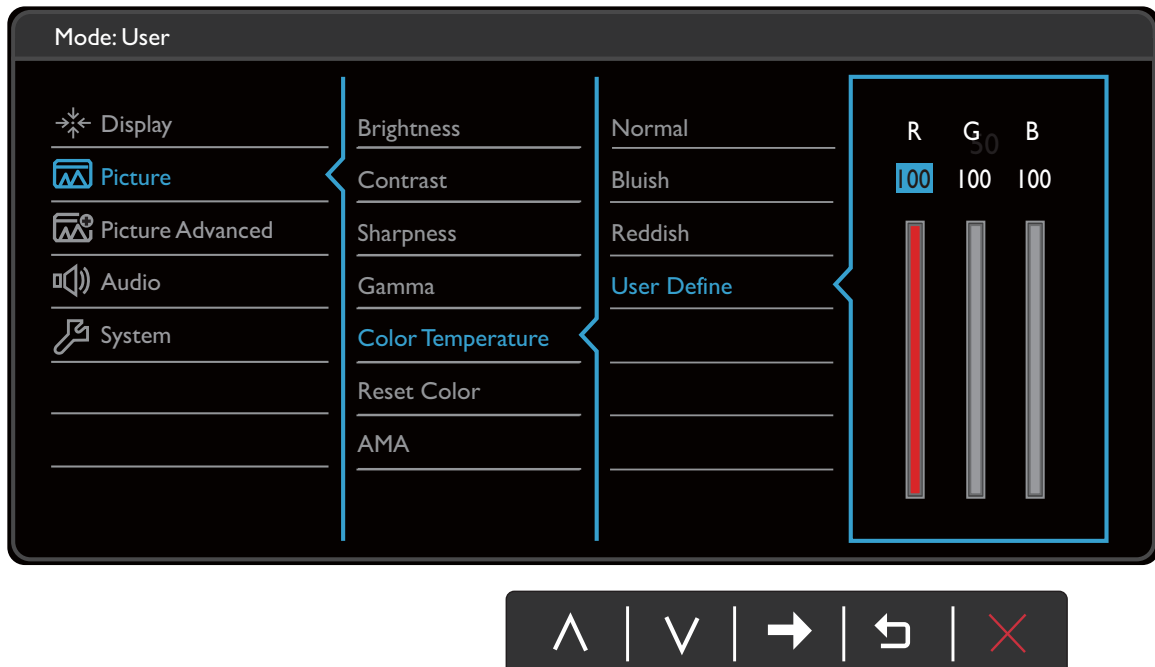
1. Select  (**Menu**) from the hot key menu.
2. Use  or  to select **Display**.
3. Select  to go to a sub menu, and then use  or  to select a menu item.
4. Use  or  to make adjustments, or use **OK** to make selection.
5. To return to the previous menu, select .
6. To exit the menu, select .











Item	Function	Range
PIP/PBP	<p>Sets the PIP or PBP mode. Pictures from two independent video sources are displayed on the screen at the same time.</p> <p> The audio input is from the main source if the PIP/PBP mode is activated.</p>	

Item	Function		Range
	Mode	Sets the PIP or PBP mode. PIP: the Picture-in-Picture (PIP) mode displays the main video source on the screen while the second source in an inset window. PBP: Allows to display images from two different video sources side-by-side. OFF: Disables PIP/PBP mode.	<ul style="list-style-type: none"> • PIP • PBP • OFF
	PIP/PBP source	Sets the second video source for the PIP/PBP mode.	<ul style="list-style-type: none"> • HDMI 1 • HDMI 2 • DisplayPort • USB-C
	SWAP	Videos from the main and the second sources are swapped on the screen.	
	PIP Size	Determines the size of the inset window in the PIP mode.	<ul style="list-style-type: none"> • Small • Medium • Large
	PIP Position	Adjusts the position of the inset window in the PIP mode.	<ul style="list-style-type: none"> • Top Right • Top Left • Bottom Right • Bottom Left
Input	Use this to change the input to that appropriate to your video cable connection type.		<ul style="list-style-type: none"> • HDMI 1 • HDMI 2 • DisplayPort • USB-C

Picture menu

Available menu options may vary depending on the input sources, functions and settings. Menu options that are not available will become grayed out. Keys that are not available will be disabled and the corresponding OSD icons will disappear. For models without certain functions, their settings and related items will not appear on the menu.



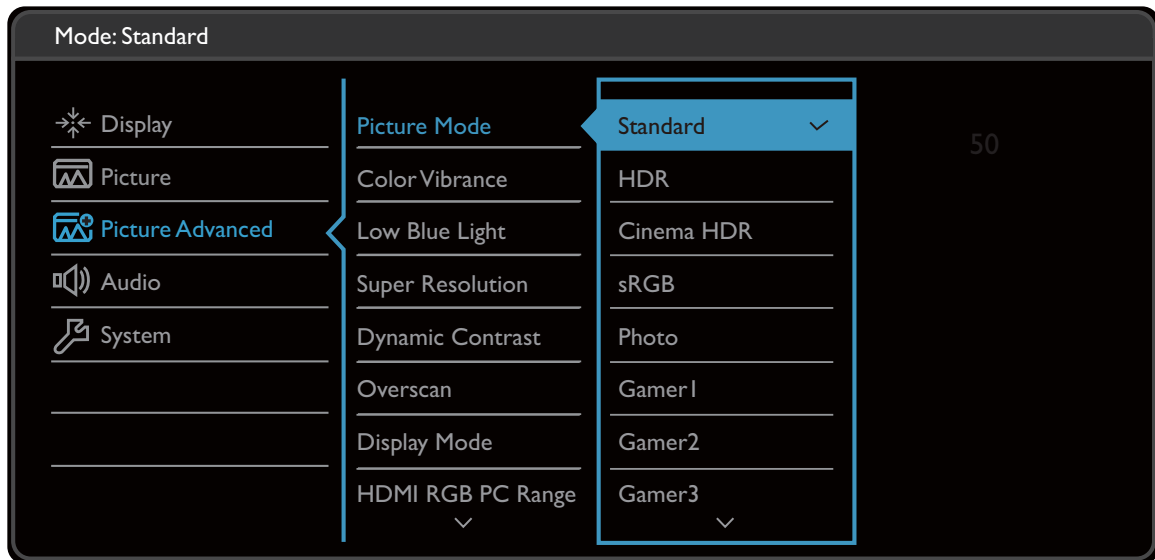
1. Select  (**Menu**) from the hot key menu.
2. Use  or  to select **Picture**.
3. Select  to go to a sub menu, and then use  or  to select a menu item.
4. Use  or  to make adjustments, or use **OK** to make selection.
5. To return to the previous menu, select .
6. To exit the menu, select .











Item	Function	Range
Brightness	Adjusts the balance between light and dark shades.	0 to 100
Contrast	Adjusts the degree of difference between darkness and lightness.	0 to 100
Sharpness	Adjusts the clarity and visibility of the edges of the subjects in the image.	1 to 10

Item	Function		Range
Gamma	Adjusts the tone luminance. The default value is 3 (the standard value for Windows).		<ul style="list-style-type: none"> •1 •2 •3 •4 •5
Color Temperature	Normal	Allows video and still photographs to be viewed with natural coloring. This is the factory default color.	
	Bluish	Applies a cool tint to the image and is factory pre-set to the PC industry standard white color.	
	Reddish	Applies a warm tint to the image and is factory pre-set to the news print standard white color.	
	User Define	<p>The blend of the Red, Green and Blue primary colors can be altered to change the color tint of the image. Go to the succeeding R (red), G (green), and B (blue) menus to change the settings.</p> <p>Decreasing one or more of the colors will reduce their respective influence on the color tint of the image. (e.g. if you reduce the Blue level the image will gradually take on a yellowish tint. If you reduce Green, the image will become a magenta tint.)</p>	<ul style="list-style-type: none"> • R (0~100) • G (0~100) • B (0~100)
Reset Color	Resets the custom color settings to the factory defaults.		<ul style="list-style-type: none"> •YES •NO
AMA	Improves the gray level response time of the LCD panel.		<ul style="list-style-type: none"> •OFF •High •Premium



Picture Advanced menu



Available menu options may vary depending on the input sources, functions and settings. Menu options that are not available will become grayed out. Keys that are not available will be disabled and the corresponding OSD icons will disappear. For models without certain functions, their settings and related items will not appear on the menu.



1. Select  (**Menu**) from the hot key menu.
2. Use  or  to select **Picture Advanced**.
3. Select  to go to a sub menu, and then use  or  to select a menu item.
4. Use  or  to make adjustments, or use **OK** to make selection.
5. To return to the previous menu, select .
6. To exit the menu, select .

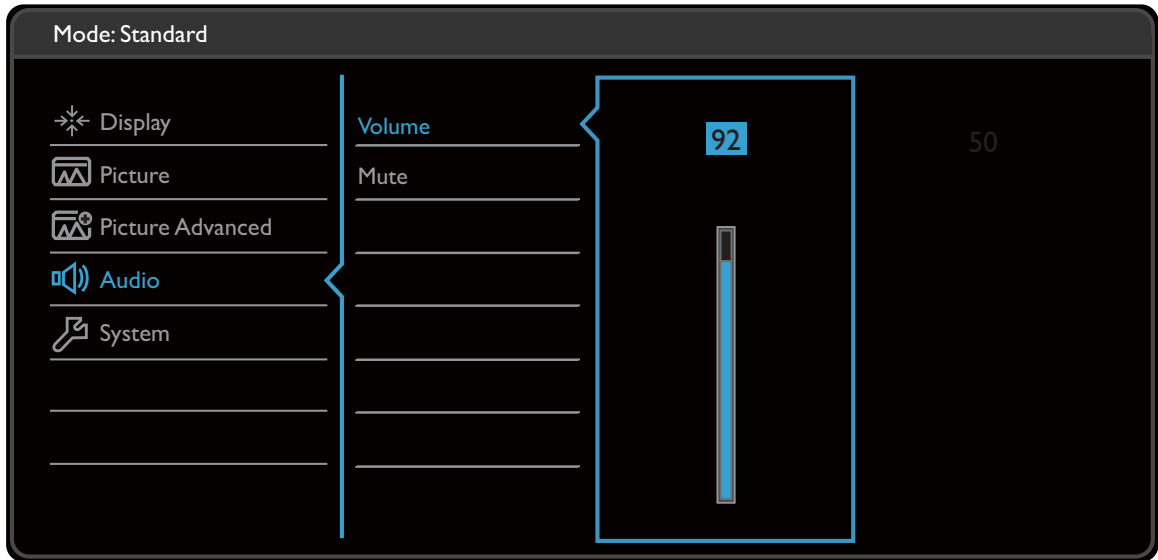
Item	Function		Range
Picture Mode	Select a picture mode that best suits the type of images shown on the screen.		
	Standard	For basic PC application.	
	HDR	For better color matching representation with High Dynamic Range (HDR) technology.	
	Cinema HDR	For better color matching representation with enhanced High Dynamic Range (HDR) technology.	











Item	Function		Range
	sRGB	For better color matching representation with the peripheral devices, such as printers, digital cameras, etc.	
	Photo	For viewing still images.	
	Gamer1	For playing car racing games.	
	Gamer2	For playing CS:GO games.	
	Gamer3	For playing Battlefield games.	
	Custom 1	Applies a combination of color settings defined by users.	
	Custom 2		
	M-book	Minimizes the visual differences between the monitor and the connected MacBook series product.	
Color Vibrance	Provides different sets of color settings. Once applied, you can adjust some of the color settings in the corresponding menus.		0 ~ 20
Low Blue Light	<p>Decreases the blue light emitted from the display to reduce the risk of blue light exposure to your eyes.</p>  The higher the value is, the more blue light has been decreased.		0 ~ 20
Super Resolution	Simulates high-resolution images by increasing pixel density of low-resolution ones.		<ul style="list-style-type: none"> • 0 • 1 • 2 • 3
Dynamic Contrast	The function is to automatically detect the distribution of an input visual signal, and then to create the optimal contrast.		0 to 5
Overscan	<p>Slightly enlarges the input image. Use this feature to hide annoying edge noise if present around your image.</p>  Available only when the input source is HDMI.		<ul style="list-style-type: none"> • ON • OFF

Item	Function	Range	
Display Mode	<p>This feature is provided to allow aspect ratios other than 16:9 to be displayed without geometric distortion.</p> <p> The options under Display Mode will be different depending on the input signal sources.</p> <p> Depending on your selection of Picture Mode, different Display Mode option is pre-set. Change the setting if needed.</p>		
	Full	Scales the input image to fill the screen. Ideal for 16:9 aspect images.	
	Aspect	The input image is displayed without geometric distortion filling as much of the display as possible.	
	1 : 1	Displays the input image in its native resolution without scaling.	
HDMI RGB PC Range	Determines the range of color scales. Select an option that matches the RGB range setting on the connected HDMI device.	<ul style="list-style-type: none"> • Auto Detect • RGB (0 ~ 255) • RGB (16 ~ 235) 	
B.I.+ (Bright Intelligence Plus)	Turns the Bright Intelligence Plus function on or off. The built-in light sensor works with Bright Intelligence Plus technology to detect the ambient light, image brightness, contrast, and color temperature, and then balance the screen automatically.	<ul style="list-style-type: none"> • ON • OFF 	
	Light Meter	Sets to display the light condition around the monitor on the screen.	<ul style="list-style-type: none"> • ON • OFF
	Sensor Sensitivity	Adjusts sensitivity of light sensor to change the brightness range to be detected. This may be helpful to correct uneven lighting in light detection.	0 ~ 100

Audio menu

Available menu options may vary depending on the input sources, functions and settings. Menu options that are not available will become grayed out. Keys that are not available will be disabled and the corresponding OSD icons will disappear. For models without certain functions, their settings and related items will not appear on the menu.

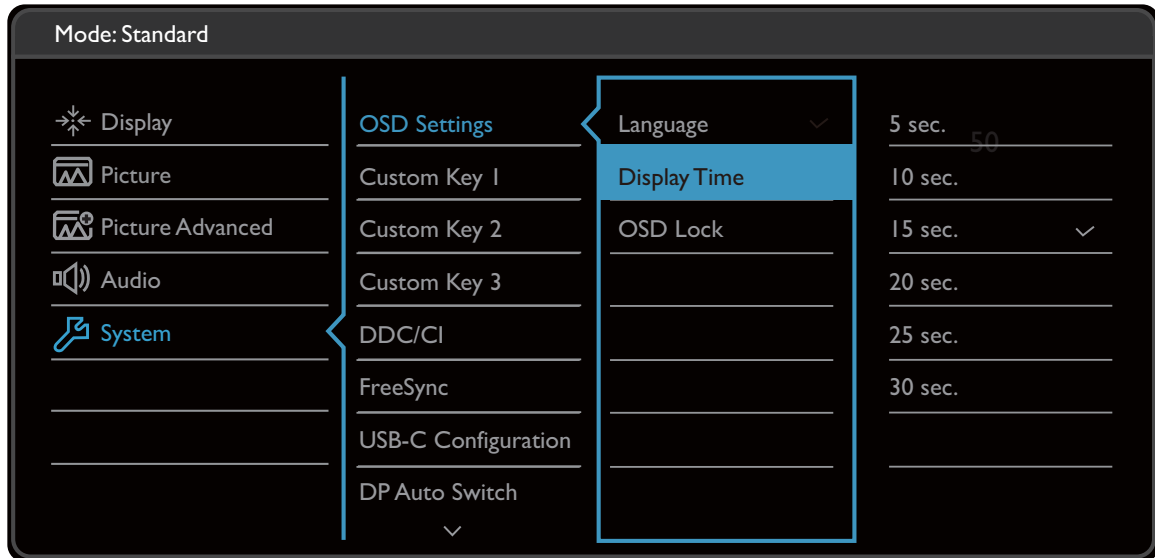












1. Select  (**Menu**) from the hot key menu.
2. Use  or  to select **Audio**.
3. Select  to go to a sub menu, and then use  or  to select a menu item.
4. Use  or  to make adjustments, or use **OK** to make selection.
5. To return to the previous menu, select .
6. To exit the menu, select .



Item	Function	Range
Volume	Adjusts the audio volume.	0 ~ 100
Mute	Mutes the audio input.	<ul style="list-style-type: none"> • ON • OFF


System menu


Available menu options may vary depending on the input sources, functions and settings. Menu options that are not available will become grayed out. Keys that are not available will be disabled and the corresponding OSD icons will disappear. For models without certain functions, their settings and related items will not appear on the menu.



1. Select  (**Menu**) from the hot key menu.
2. Use  or  to select **System**.
3. Select  to go to a sub menu, and then use  or  to select a menu item.
4. Use  or  to make adjustments, or use **OK** to make selection.
5. To return to the previous menu, select .
6. To exit the menu, select .

Item	Function		Range
OSD Settings	Language	<p>Sets the OSD menu language.</p>  <p>The language options displayed on your OSD may differ from those shown on the right, depending on the product supplied in your region.</p>	<ul style="list-style-type: none"> • English • Français • Deutsch • Italiano • Español • Polski • Česky • Magyar • Română • Nederlands • Русский • Svenska • Português • العربية • 日本語 • 한국어 • 繁體中文 • 简体中文
	Display Time	Adjusts the display time of the OSD menu.	<ul style="list-style-type: none"> • 5 sec. • 10 sec. • 15 sec. • 20 sec. • 25 sec. • 30 sec.
	OSD Lock	<p>Prevents all the monitor settings from being accidentally changed. When this function is activated, the OSD controls and hotkey operations will be disabled.</p>  <p>To unlock the OSD controls, press and hold any key for 10 seconds.</p>	

Item	Function	Range
Custom Key 1	Sets the function to be accessed by custom key 1.	<ul style="list-style-type: none"> • Picture Mode • Color Vibrance • Brightness • Low Blue Light • Super Resolution • Display Mode • Volume • Contrast
Custom Key 2	Sets the function to be accessed by custom key 2.	
Custom Key 3	Sets the function to be accessed by custom key 3.	
DDC/CI	<p>Allows the monitor settings to be set through the software on the PC.</p>  DDC/CI, short for Display Data Channel/Command Interface, which was developed by Video Electronics Standards Association (VESA). DDC/CI capability allows monitor controls to be sent via the software for remote diagnostics.	<ul style="list-style-type: none"> • ON • OFF
FreeSync	Enables FreeSync function to eliminate screen tearing, stuttering, and juddering during gaming.	<ul style="list-style-type: none"> • Normal • Premium
USB-C Configuration	Sets the refresh rate of the input video via USB-C™ port. The USB transmission speed changes accordingly due to USB-C™ technology limitation. See Options for data transfer via USB-C™ on page 43 for more information.	<ul style="list-style-type: none"> • QHD@120Hz + USB 2.0 • QHD@60Hz + USB 3.1
DP Auto Switch	When this function is activated, DP port will be in the input auto select loop. Otherwise, DP can only be selected by input select or by hot key.	<ul style="list-style-type: none"> • ON • OFF
HDMI Auto Switch	When this function is activated, HDMI port will be in the input auto select loop. Otherwise, HDMI can only be selected by input select or by hot key.	<ul style="list-style-type: none"> • ON • OFF
USB-C Auto Switch	When this function is activated, USB-C™ port will be in the input auto select loop. Otherwise, USB-C™ can only be selected by input select or by hot key.	<ul style="list-style-type: none"> • ON • OFF
Auto Power Off	Sets the time to power off the monitor automatically in power saving mode.	<ul style="list-style-type: none"> • OFF • 10min. • 20min. • 30min.
Resolution Notice	Sets whether to display the resolution notice of the recommended resolution when a new input source is detected by the monitor.	<ul style="list-style-type: none"> • ON • OFF

Item	Function	Range
HDR Demo	<p>(Works only if the input content is HDR-compatible) When the function is activated, all picture modes are available for a comparison between HDR and non-HDR image representation.</p> <p> If this function is activated and a non-HDR mode is selected, the input HDR content may be represented inappropriately.</p>	<ul style="list-style-type: none"> • ON • OFF
Information	Displays the current monitor property settings.	<ul style="list-style-type: none"> • Input • Current Resolution • Optimum Resolution (best with the monitor) • HDR • Model Name
DisplayPort	Selects an appropriate DP standard for data transmission.	<ul style="list-style-type: none"> • 1.1 • 1.4
Reset All	Resets all mode, color and geometry settings to the factory default values.	<ul style="list-style-type: none"> • YES • NO













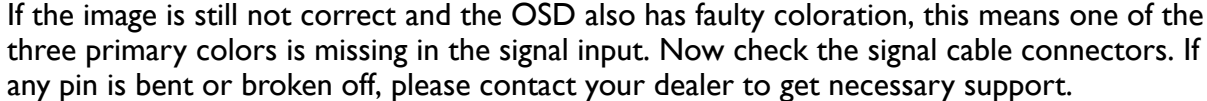






Options for data transfer via USB-C™

	2560 x 1440@120Hz + USB 2.0	2560 x 1440@60Hz + USB 3.1
Refresh rate	120 Hz	60 Hz
USB transmission speed	480Mbps	5Gbps

Troubleshooting

Frequently asked questions (FAQ)

Imaging

-  The image is blurred.
-  Read the instructions on the link "**Adjusting the Screen Resolution**" on the CD, and then select the correct resolution, refresh rate and make adjustments based on these instructions.
-  Does the blurring only occur at resolutions lower than the native (maximum) resolution?
-  Read the instructions on the link "**Adjusting the Screen Resolution**" on the CD. Select the native resolution.
-  Pixel errors can be seen.
 -  One of several pixels is permanently black, one or more pixels are permanently white, one or more pixels are permanently red, green, blue or another color.
 -  • Clean the LCD screen.
 -  • Cycle power on-off.
 -  • These are pixels that are permanently on or off and is a natural defect that occurs in LCD technology.
-  The image has a faulty coloration.
-  It has a yellow, blue or pink appearance.
 -  Go to **Picture** and **Reset Color**, and then choose **YES** to reset the color settings to the factory defaults.
 -  If the image is still not correct and the OSD also has faulty coloration, this means one of the three primary colors is missing in the signal input. Now check the signal cable connectors. If any pin is bent or broken off, please contact your dealer to get necessary support.
-  The image is distorted, flashes or flickers.
-  Read the instructions on the link "**Adjusting the Screen Resolution**" on the CD, and then select the correct resolution, refresh rate and make adjustments based on these instructions.
-  You are running the monitor at its native resolution, but the image is still distorted.
-  Images from different input sources may appear distorted or stretched on the monitor running at its native resolution. To have the optimal display performance of each type of input sources, you can use the **Display Mode** function to set a proper aspect ratio for the input sources. See [Display Mode on page 38](#) for details.
-  The image is displaced in one direction.
-  Read the instructions on the link "**Adjusting the Screen Resolution**" on the CD, and then select the correct resolution, refresh rate and make adjustments based on these instructions.

? Faint shadow from the static image displayed is visible on the screen.

- ✓ • Activate the power management function to let your computer and monitor go into a low power "sleep" mode when not actively in use.
- Use a screensaver to prevent the occurrence of image retention.

Power LED indicator

? The LED indicator is white or orange.

- ✓ • If the LED lights up in solid white, the monitor is powered on.
- If the LED is illuminated in white and there is a message **Out of Range** on the screen, this means you are using a display mode that this monitor does not support, please change the setting to one of the supported mode. Please read the "**Preset display modes**" section from the link "**Adjusting the Screen Resolution**".
- If the LED is illuminated in orange, the power management mode is active. Press any button on the computer keyboard or move the mouse. If that does not help, check the signal cable connectors. If any pin is bent or broken off, please contact your dealer to get necessary support.
- If the LED is off, check the power supply mains socket, the external power supply and the mains switch.

OSD controls

? The OSD controls are inaccessible.

- ✓ To unlock the OSD controls when it is preset to be locked, press and hold any key for 10 seconds.

OSD messages

? A message **Out of Range** on the screen during computer boot up process.

- ✓ If there is a message **Out of Range** on the screen during computer boot up process, this means computer compatibility caused by operating system or graphic card. The system will adjust the refresh rate automatically. Just wait until the operating system is launched.

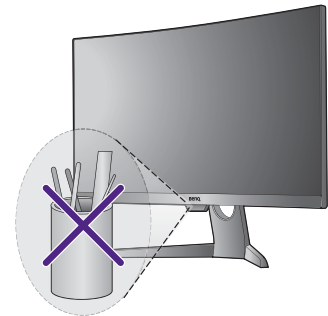
Audio

? No sound can be heard from the connected external speakers.

- ✓ • Remove your headphone (if the headphone is connected to the monitor).
- Check whether the headphone jack is properly connected.
- If the external speakers are USB-powered, check whether the USB connection is OK.
- Increase the volume (volume may be muted or too low) on the external speakers.
- If USB-C™ connection is established, make sure the appropriate audio output setting on your laptop has been selected. You may look for options similar to "USB headphone".

Sensors

- ❓ The light sensor of the monitor does not work well.
- ✓ The light sensor is located at the front bottom of the monitor. Please check:
 - If you have removed the sensor protection sticker.
 - If the **Bright Intelligence** function is set to **ON**. Check **Picture Advanced > B. I. +**.
 - If there are any obstacles in front of the sensor that keep the sensor from detecting the light properly.
 - If there are any objects or clothing in bright colors in front of the sensor. Bright colors (especially white and fluorescent colors) reflect light and the sensor cannot detect the main light sources.



USB-C™ connection

- ❓ No video or audio output from the laptop with USB-C™ connection.
- ✓ Check the cable connections and menu settings in the following order:
 - Check if the USB-C™ cable has been connected to the monitor and the laptop properly. See [Connect the PC video cable. on page 11](#) for more information.
 - Check if the input source has been selected to **USB-C** on **Display > Input**.

HDR

- ❓ There is a message **HDR: Emulated** showing on the screen.
- ✓ This means the input content is not HDR-compatible and the monitor is in HDR-emulated mode. Refer [Working with HDR technology on page 27](#) to check if a supported player, content, and the certified cable are used.

Need more help?

If your problems remain after checking this manual, please contact your place of purchase or visit the local website from www.BenQ.com for more support and local customer service.