



LCD Monitor User Manual

PhotoVue Photographer Monitor | SW Series

AQ COLOR™
Colors You Can Trust

Copyright

Copyright © 2020 by BenQ Corporation. All rights reserved. No part of this publication may be reproduced, transmitted, transcribed, stored in a retrieval system or translated into any language or computer language, in any form or by any means, electronic, mechanical, magnetic, optical, chemical, manual or otherwise, without the prior written permission of BenQ Corporation.

Disclaimer

BenQ Corporation makes no representations or warranties, either expressed or implied, with respect to the contents hereof and specifically disclaims any warranties, merchantability or fitness for any particular purpose. Further, BenQ Corporation reserves the right to revise this publication and to make changes from time to time in the contents hereof without obligation of BenQ Corporation to notify any person of such revision or changes.

The performance of flicker-free may be affected by external factors such as poor cable quality, unstable power supply, signal interference, or poor grounding, and not limited to the above mentioned external factors. (Applicable for flicker-free models only.)

BenQ ecoFACTS

BenQ has been dedicated to the design and development of greener product as part of its aspiration to realize the ideal of the "Bringing Enjoyment 'N Quality to Life" corporate vision with the ultimate goal to achieve a low-carbon society. Besides meeting international regulatory requirement and standards pertaining to environmental management, BenQ has spared no efforts in pushing our initiatives further to incorporate life cycle design in the aspects of material selection, manufacturing, packaging, transportation, using and disposal of the products. BenQ ecoFACTS label lists key eco-friendly design highlights of each product, hoping to ensure that consumers make informed green choices at purchase. Check out BenQ's CSR Website at <http://csr.BenQ.com/> for more details on BenQ's environmental commitments and achievements.



Product support

This document aims to provide the most updated and accurate information to customers, and thus all contents may be modified from time to time without prior notice. Please visit the website for the latest version of this document and other product information. Available files vary by model.

1. Make sure your computer is connected to the Internet.
2. Visit the local website from www.BenQ.com. The website layout and content may vary by region/country.
 - User manual and related document: www.BenQ.com > **Support** > **Download & FAQ** > model name > **User Manual**
 - Drivers and applications: www.BenQ.com > **Support** > **Download & FAQ** > model name > **Software**

Safety precautions

Power safety



Please follow these safety instructions for best performance, and long life for your monitor.

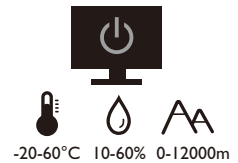
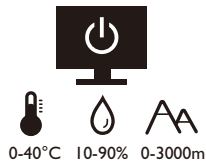

- The AC plug isolates this equipment from the AC supply.
- The power supply cord serves as a power disconnect device for pluggable equipment. The socket outlet should be installed near the equipment and be easily accessible.
- This product should be operated from the type of power indicated on the marked label. If you are not sure of the type of power available, consult your dealer or local power company.
- The Class I pluggable equipment Type A must be connected to protective earth.
- An approved power cord greater or equal to H03VV-F or H05VV-F, 2G or 3G, 0.75mm² must be used.
- Use only the power cord provided by BenQ. Never use a power cord that appears to be damaged or frayed.

For Germany only:

- (If the weight of the product is less than (or equal to 3 kg) An approved power cord greater or equal to H03VV-F, 3G, 0.75mm² must be used.
- (If the weight of the product is more than 3 kg) An approved power cord greater or equal to H05VV-F or H05RR-F, 3G, 0.75mm² must be used.
- (If a remote control is provided) **RISK OF EXPLOSION IF BATTERY IS REPLACED BY AN INCORRECT TYPE. DISPOSE OF USED BATTERIES ACCORDING TO THE INSTRUCTIONS.**

For models with adapter:

- Use only the power adapter supplied with your LCD Monitor. Use of another type of power adapter will result in malfunction and/or danger.
- Allow adequate ventilation around the adapter when using it to operate the device or charge the battery. Do not cover the power adapter with paper or other objects that will reduce cooling. Do not use the power adapter while it is inside a carrying case.
- Connect the power adapter to a proper power source.
- Do not attempt to service the power adapter. There are no service parts inside. Replace the unit if it is damaged or exposed to excess moisture.

Care and cleaning

- Do not place the monitor face down on the floor or a desk surface directly. Otherwise, scratches on the panel surface may occur.
- The equipment is to be secured to the building structure before operation.
- (For models that support wall or ceiling mounting)
 - Install your monitor and monitor mounting kit on a wall with flat surface.
 - Ensure that the wall material and the standard wall mount bracket (purchased separately) are stable enough to support the weight of the monitor.
 - Turn off the monitor and the power before disconnecting the cables from the LCD monitor.
- Always unplug the product from the power outlet before cleaning. Clean the LCD monitor surface with a lint-free, non-abrasive cloth. Do not use any liquid, aerosol, glass or alcohol cleaners. To clean the monitor screen, see [Cleaning the LCD screen on page 6](#) for details.
- Slots and openings on the back or top of the cabinet are for ventilation. They must not be blocked or covered. Your monitor should never be placed near or over a radiator or heat sources, or in a built-in installation unless proper ventilation is provided.
- Do not place heavy loads on the monitor to avoid possible personal injury or damage to the monitor.
- Consider keeping the box and packaging in storage for use in the future when you may need to transport the monitor.
- Refer to the product label for information on power rating, manufacture date, and identification markings.

Servicing

- Do not attempt to service this product yourself, as opening or removing covers may expose you to dangerous voltages or other risks. If any of the above mentioned misuse or other accident such as dropping or mishandling occurs, contact qualified service personnel for servicing.
- Contact your place of purchase or visit the local website from www.BenQ.com for more support.

Caution

- The monitor should be 50 ~ 70 cm (20 ~ 28 inches) away from your eyes.
- Looking at the screen for an extended period of time causes eye fatigue and may deteriorate your eyesight. Rest your eyes for 5 ~ 10 minutes for every 1 hour of product use.
- Reduce your eye strain by focusing on objects far way.
- Frequent blinking and eye exercise help keep your eyes from drying out.

Cleaning the LCD screen



Please follow these safety instructions for best performance, and long life for your monitor.

Due to the special panel coating, smudges and fingerprints on the monitor screen could be obvious. Be sure to follow the instructions to clean the screen surface appropriately.

Using the screen cleaning roller (recommended)

There is one screen cleaning roller in the product package. The supplied roller is highly recommended to clean your monitor screen. It is an eco-friendly design as it is reusable, washable, and liquid-free.

1. Unplug the monitor from the power outlet before cleaning.
2. Take the roller out of its box. Make sure there is no sharp debris on the roller surface to avoid scratching the screen.

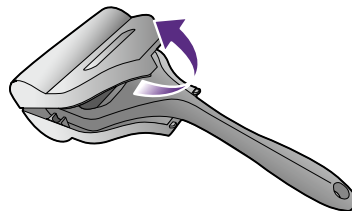

3. Move the roller on the stained area of the screen gently. It helps remove dust, fingerprints, and smudges from the monitor screen. Hold the edge of the monitor and avoid excessive force on the screen.

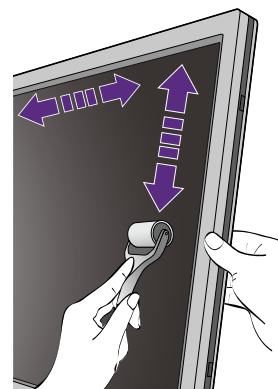
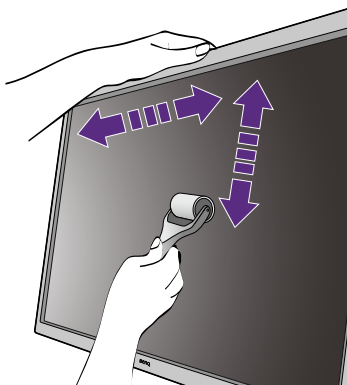

Care and storage

- The roller may get dirty after using several times and may not be able to clean the screen properly. Wash it under running water and remove debris from the roller by hand if necessary. Keep it in a cool place until it is dry. Make sure it is completely dry before the next cleaning.

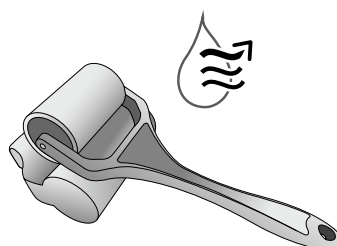
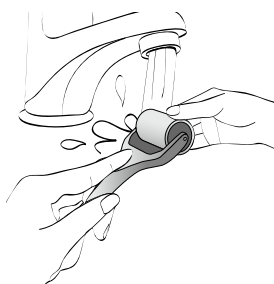

- Do not blow-dry the roller.
- Do not try to wipe the roller clean by a wet cloth or tissue as the fibers may be left on the roller and keep it from cleaning the monitor screen properly.
- Do not expose the roller to direct sunlight. Keep it away from sources of heat (such as radiators, space heaters, stoves, and so on).
- Use and store the roller between 0 °C - 40 °C. Put the roller back to its box if it is not used for a long time.

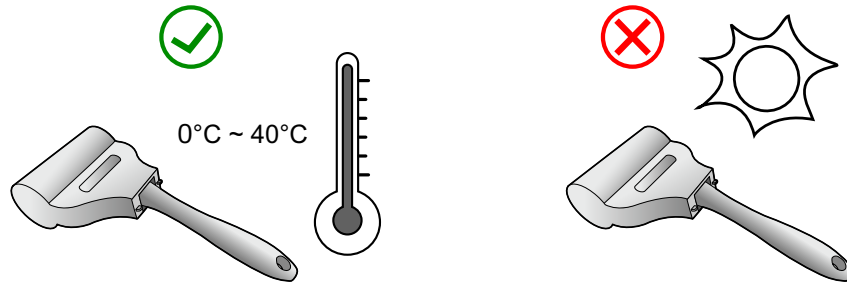

- If your monitor screen can not be cleaned up by the roller even if it is properly washed, contact local customer service for the availability of a new roller.

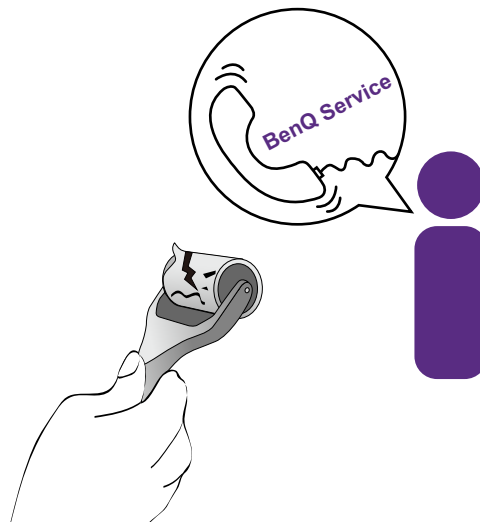

If you drop the roller by accident, dirt or tiny sharp debris may be stuck on the silicon roller. Wash and dry it before use.

Using a screen cleaner (purchased separately)

- Use screen cleaning wipes which are pre-moistened and alcohol-free. You can wipe away oil and fingerprints easily.
- Use an alcohol-free screen cleaner kit. Spray on the microfiber cloth that came with the screen cleaner kit, and wipe smudges off the screen.
- Make sure no liquid goes into the gap between the screen and the bezel. Liquids inside the monitor could cause short circuits.



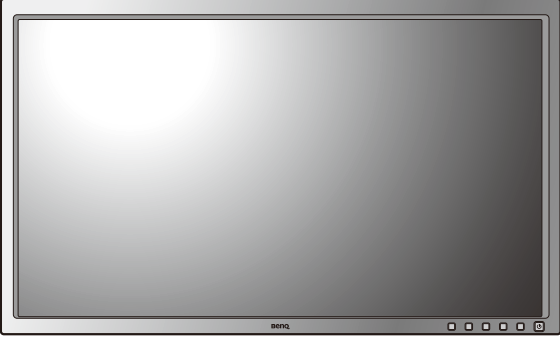

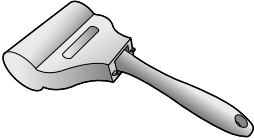

Table of Contents



Copyright	2
Product support	3
Safety precautions	4
Cleaning the LCD screen	6
Using the screen cleaning roller (recommended).....	6
Using a screen cleaner (purchased separately)	8
Getting started	11
Getting to know your monitor	14
Front view	14
Back view.....	14
Input and output ports	15
Connections	16
How to assemble your monitor hardware	18
How to detach the stand and the base	24
Installing shading hood (optional step)	26
Adjusting the monitor height	31
Rotating the monitor	32
Viewing angle adjustment	33
Using the monitor wall mounting kit	34
Getting the most from your BenQ monitor	35
Downloading the LCD Monitor driver files from the Internet	35
How to install the monitor on a new computer	36
How to upgrade the monitor on an existing computer	37
How to install on Windows 10 system	38
How to install on Windows 8 (8.1) system	39
How to install on Windows 7 system	40
How to adjust your monitor	41
The control panel.....	41
Hotkey Puck G2 and its basic operations	42
Basic menu operation	44
Customizing the hot keys.....	45
Working with HDR technology.....	45
Adjusting the display color.....	46
Adjusting display mode.....	47
Choosing an appropriate picture mode.....	47
Video source selection in PIP/PBP mode.....	47
Minimizing the color difference between the screen and the hardcopy (Paper Color Sync)	47
Navigating the main menu	49

Display menu	50
Color Adjustment menu	52
PIP/PBP menu	57
System menu	59
Controller Key menu	63
Troubleshooting	65
Frequently asked questions (FAQ)	65
Need more help?.....	67
Appendix: Advanced software	68

Getting started

When unpacking please check you have the following items. If any are missing or damaged, please contact the place of purchase for a replacement.

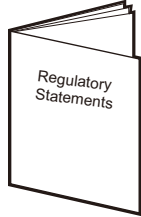
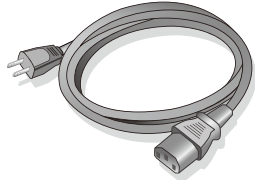
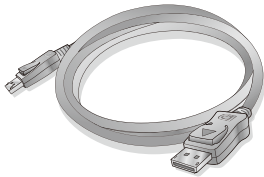
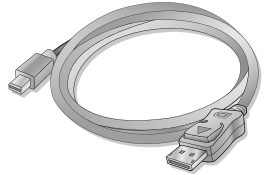
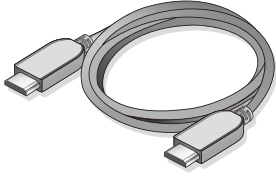
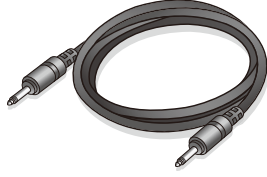
BenQ LCD Monitor	
Monitor Stand	
Monitor Base	
Screen Cleaning Roller	
Quick Start Guides (One attached to the monitor screen and the other in the package.)	
Safety Instructions	

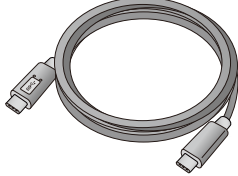
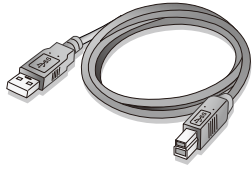
<p>Regulatory Statements</p>	
<p>Power Cord (Picture may differ from product supplied for your region.)</p>	
<p>Video Cable: DP (Optional accessory)</p>	
<p>Video Cable: DP to mini DP</p>	
<p>Video Cable: HDMI</p>	
<p>Audio Cable (Optional accessory)</p>	
<p>USB Cable: USB-C™</p> <p> Use of the supplied USB-C™ cable is recommended to ensure data transmission quality.</p>	
<p>USB Cable</p>	

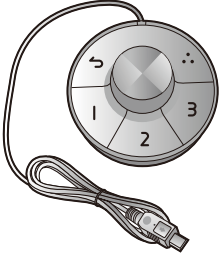
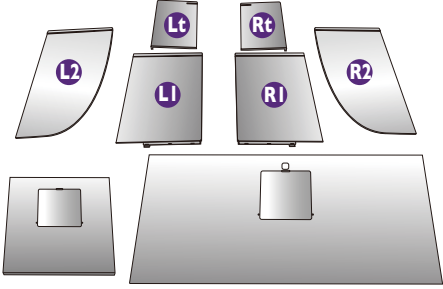
Hotkey Puck G2	
Shading hood	



- Available accessories and the pictures shown here may differ from the actual contents and the product supplied for your region. And the package contents may subject to change without prior notice. For cables that are not supplied with your product, you can purchase them separately.
- Consider keeping the box and packaging in storage for use in the future when you may need to transport the monitor. The fitted foam packing is ideal for protecting the monitor during transport.



Always keep the product and accessories out of reach of small children.

Getting to know your monitor

Front view

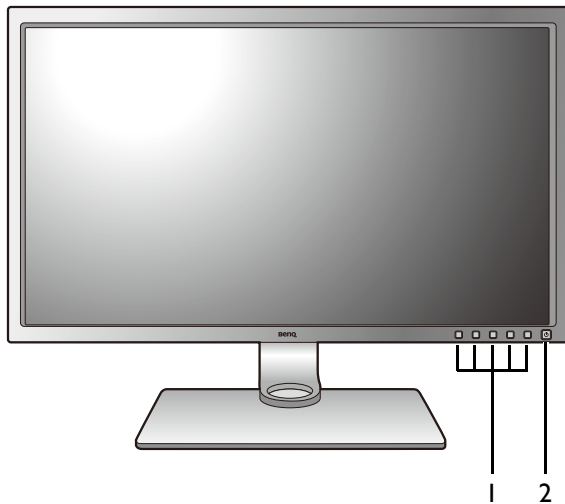

1. Control buttons
2. Power button

Back view

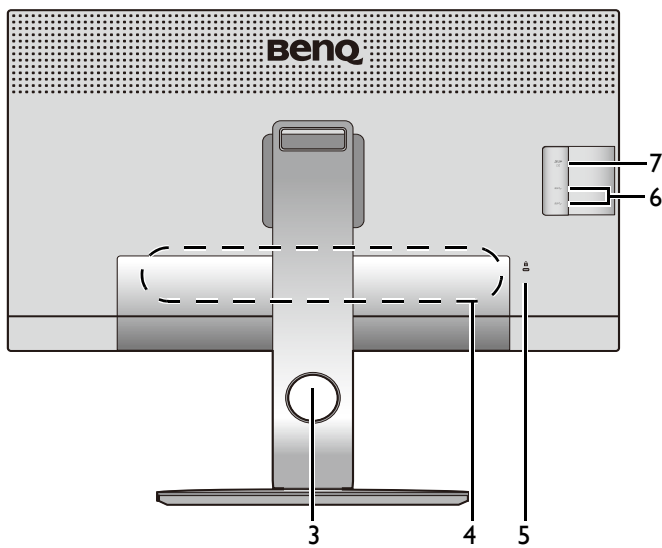

3. Cable management hole
4. Input and output ports
5. Kensington lock slot
6. USB ports (downstream; connecting to USB devices)
7. SD card slot

Input and output ports

Available input and output ports may vary depending on your purchased model. Check the product specifications on the website for details.

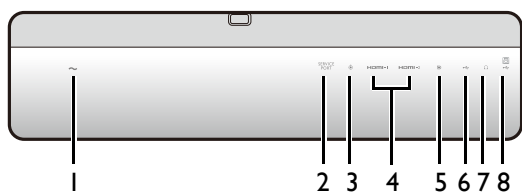

1. AC power input jack
2. Service port
3. Hotkey Puck G2 socket
4. HDMI socket
5. DisplayPort socket
6. USB-C™ port
7. Headphone jack
8. USB port (upstream; connecting to the PC)



- Depending on the product specifications, the supported resolution and timing may vary.
- Above diagram may vary depending on the model.
- Picture may differ from product supplied for your region.

Connections

The following connection illustrations are for your reference only. For cables that are not supplied with your product, you can purchase them separately.

For detailed connection methods, see page [20 - 21](#).

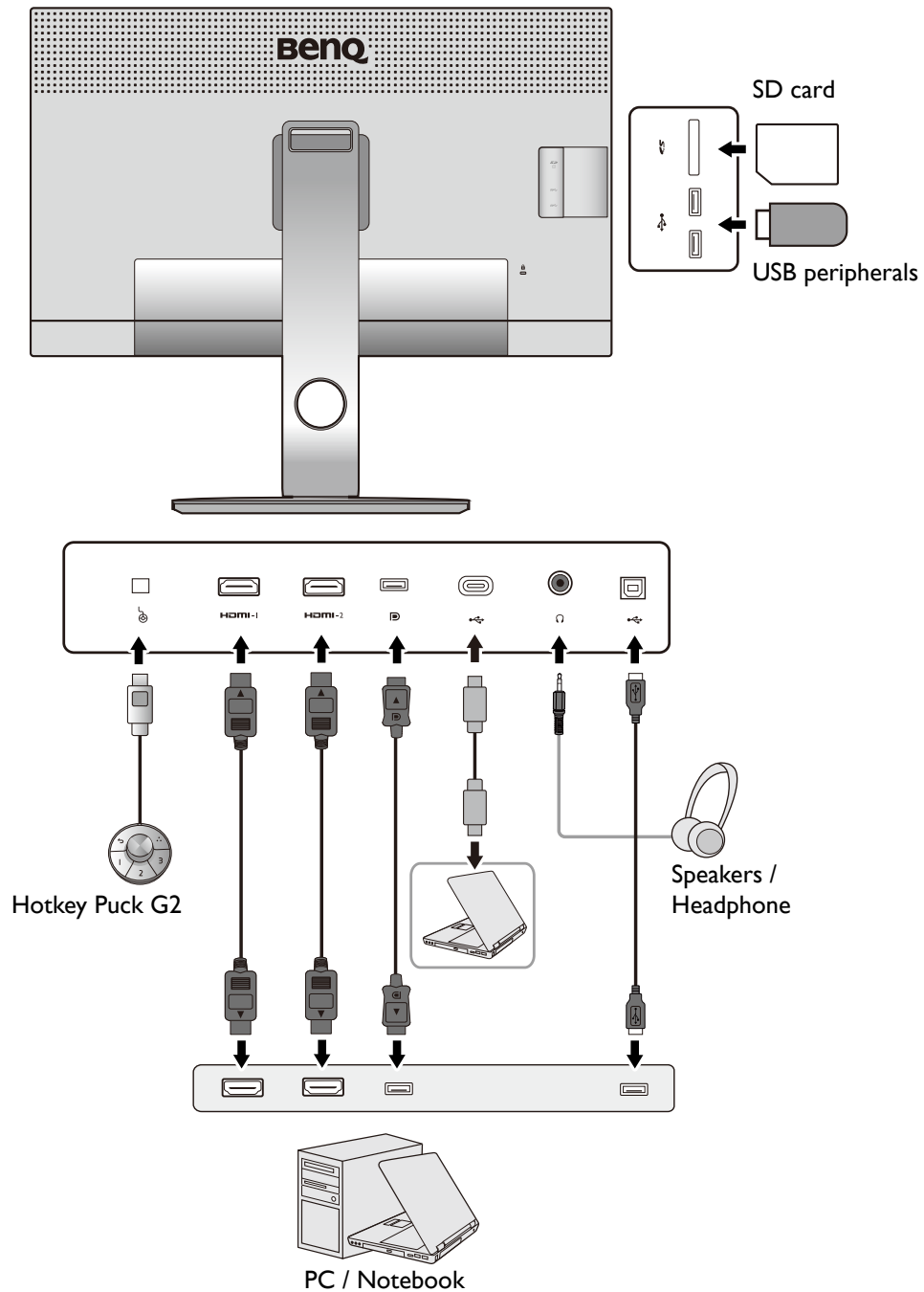

Due to USB-C™ technology limitation, the USB transmission speed is determined only by the selected refresh rate. See for [Options for data transfer via USB-C™](#) on page [62](#) more information.

Power delivery of USB-C™ port on your monitor

With the power delivery function, your monitor helps supply power to the connected USB-C™ devices.

USB-C™ Power Delivery
5V / 3A
9V / 3A
12V / 3A
15V / 3A
20V / 3A

- A connected device needs to be equipped with a USB-C™ connector that supports charging function via USB power delivery.
- The connected device can be charged via USB-C™ port even when the monitor is in power saving mode. (*)
- The USB power delivery is up to 60W. If the connected device requires more than 60W for operation or for boot up (when the battery is drained), use the original power adapter that came with the device.
- The information is based on the standard testing criteria and is provided for reference. The compatibility is not guaranteed as the user environments vary. If a separately purchased USB-C™ cable is used, make sure the cable is certified by USB-IF and is full-featured, with power delivery and video / audio / data transfer functions.



*: Charging via USB-C™ in monitor power saving mode is available when the **USB-C Awake** function is enabled. Go to **System > USB-C Awake** and select **ON**.

How to assemble your monitor hardware



- If the computer is turned on you must turn it off before continuing.
Do not plug-in or turn-on the power to the monitor until instructed to do so.
- The following illustrations are for your reference only. The location and available input and output jacks may vary depending on the purchased model.
- The supported timing may vary by input signal. Download **Resolution file** from the website (see [Product support on page 3](#)). Refer to "**Preset display modes**" in **Resolution file** for more information.



Avoid finger pressure on the screen surface.

I. Attach the monitor base.



Please be careful to prevent damage to the monitor. Placing the screen surface on an object like a stapler or a mouse will crack the glass or damage the LCD substrate voiding your warranty. Sliding or scraping the monitor around on your desk will scratch or damage the monitor surround and controls.

Protect the monitor and screen by clearing a flat open area on your desk and placing a soft item like the monitor packaging bag on the desk for padding.

Gently lay the screen face up on a flat clean padded surface so you can follow the instructions printed on the quick start guide.

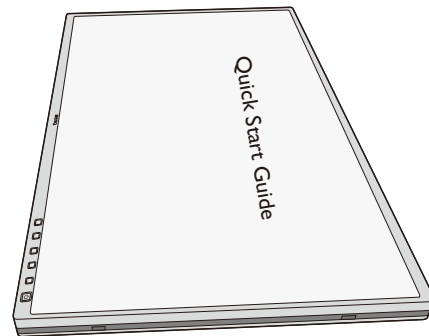

Attach the monitor stand to the monitor base as illustrated. Make sure to align the arrow on the end of the stand to the one on the monitor.

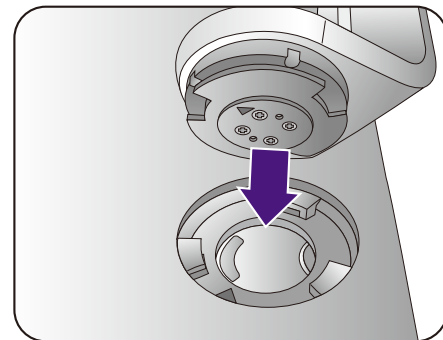

Turn the stand clockwise until you cannot go further.

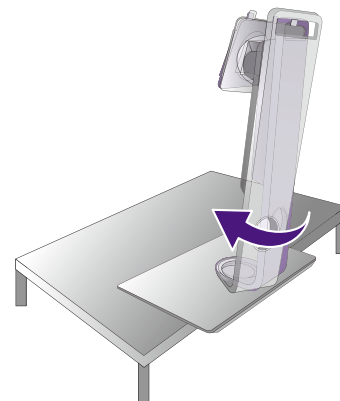

Tighten the thumbscrew on the bottom of the monitor base as illustrated. And then turn the stand counterclockwise to face forward.

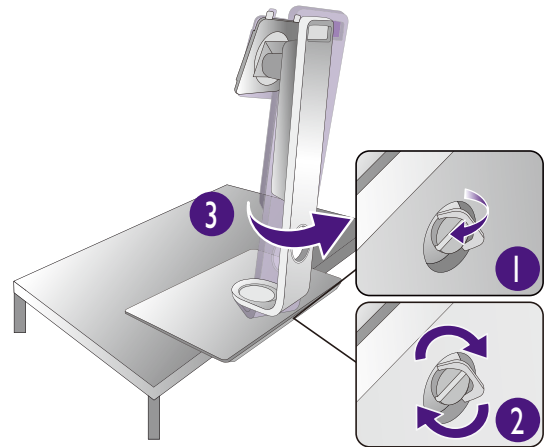

Gently turn the screen over to install the monitor stand arm and base.

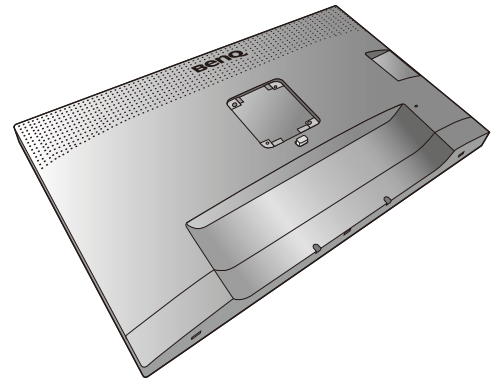

Orient and align the stand arm with the monitor (1), push them together until they click and lock into place (2).

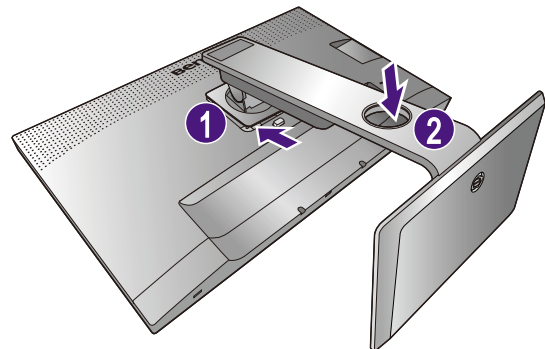

Gently attempt to pull them back apart to check that they have properly engaged.

Carefully lift the monitor, turn it over and place it upright on its stand on a flat even surface.

 You should position the monitor and angle the screen to minimize unwanted reflections from other light sources.

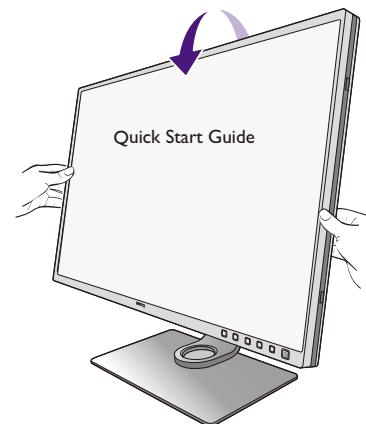

2. Connect the PC video cable



The video cables included in your package and the socket illustrations on the right may vary depending on the product supplied for your region.

To Connect the HDMI Cable

Connect the plug of the HDMI cable to the HDMI port on the monitor. Connect the other end of the cable to the HDMI port of a digital output device.

To Connect the DP Cable

Connect the plug of the DP cable to the monitor video socket. Connect the other end of the cable to the computer video socket.



After the monitor and the computer are powered on, if the image is not displayed, disconnect the DP cable. Connect the monitor to any video source other than DP first. Go to **System** and **DP** on the OSD menu of the monitor and change the setting from 1.4 to 1.1. Once the setting is done, unplug the current video cable and re-connect the DP cable. To go to the OSD menu, see [Basic menu operation on page 44](#).

To Connect the USB-C™ Cable

Connect the plug of the supplied USB-C™ cable to the USB-C™ port on the monitor. Connect the other end of the cable to the USB-C™ port of a laptop. It allows signal, audio, and data transmission from the laptop to the monitor.



The USB-C™ port on the monitor supports power delivery. See [Power delivery of USB-C™ port on your monitor on page 17](#) for more information. If a separately purchased USB-C™ cable is used, make sure the cable is certified by USB-IF and is full-featured, with power delivery and video / audio / data transfer functions.



Due to USB-C™ technology limitation, the USB transmission speed is determined only by the selected refresh rate. See [USB-C Configuration on page 61](#) and [Options for data transfer via USB-C™ on page 62](#) for more information.

Either

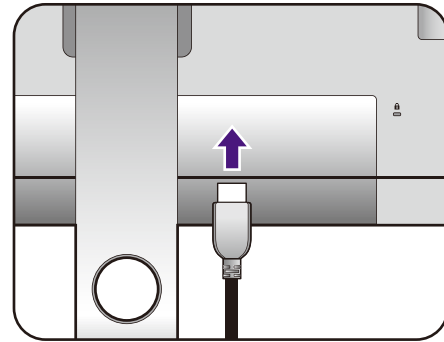

Or

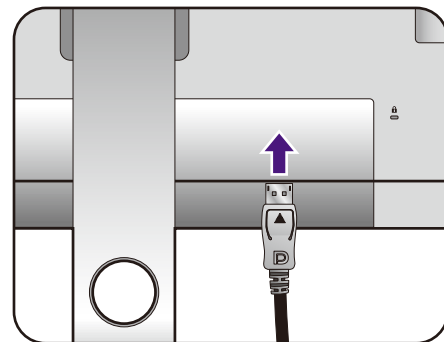

Or

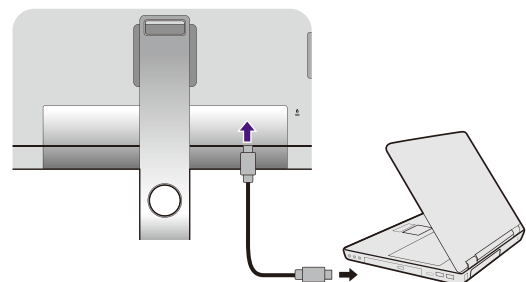

3. Connect the audio cable.

You may connect headphones to the headphone jack found on the back side of the monitor.

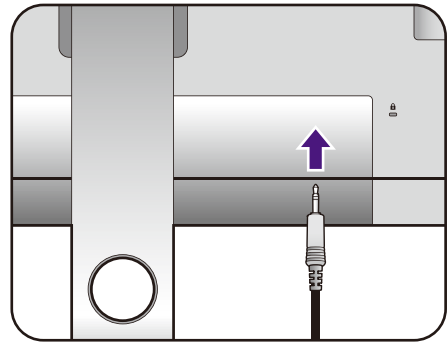

4. Connect USB devices.

To Connect the USB Type-B Cable

Connect the USB cable between the PC and the monitor (via the upstream USB port at the back). This upstream USB port transmits data between the PC and the USB devices connected to the monitor.

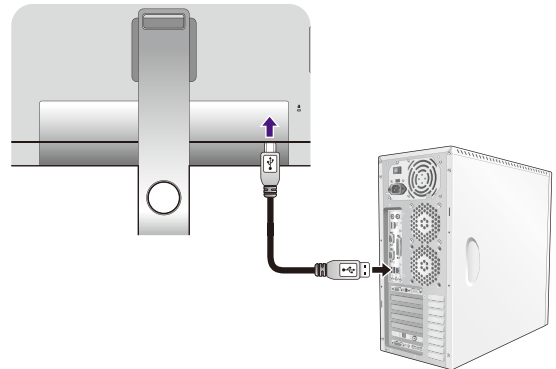

Connect USB devices via other USB ports (downstream) on the monitor. These downstream USB ports transmit data between connected USB devices and the upstream port.



The USB hubs (downstream ports) are available when either the USB Type-B or Type-C™ port is in use.

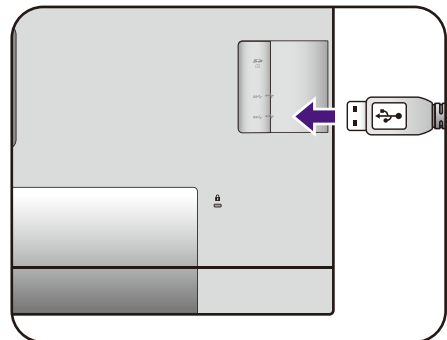

5. Connect the memory card.

Insert an SD or MMC memory card following the direction indicated on the card to exchange files.



Supported memory card formats are as follows:

- SD / SDHC / SDXC
- MMC

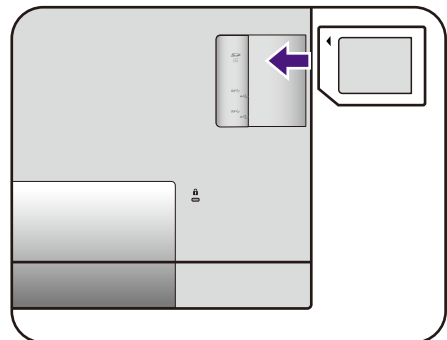

6. Connect the Hotkey Puck G2 to the monitor.

Connect the Hotkey Puck G2 to the mini USB port (exclusively for Hotkey Puck connection) on the rear of the monitor.

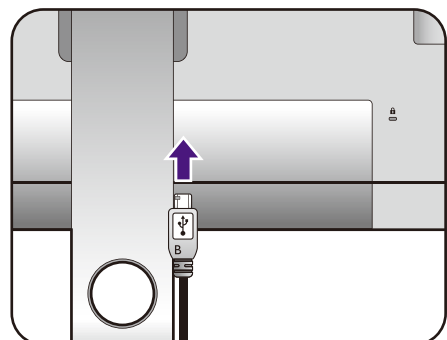

And place the Hotkey Puck G2 on the monitor stand or to another desired place as illustrated.

For more information on Hotkey Puck G2, see [Hotkey Puck G2 and its basic operations](#).

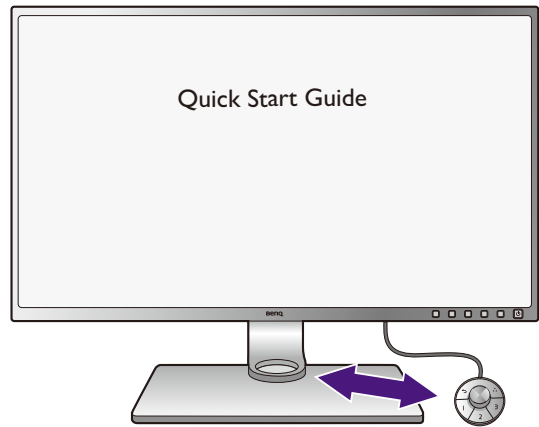

7. Connect the power cable to the monitor.

Plug one end of the power cord into the socket labelled  on the rear of the monitor. Do not connect the other end to a power outlet just yet.

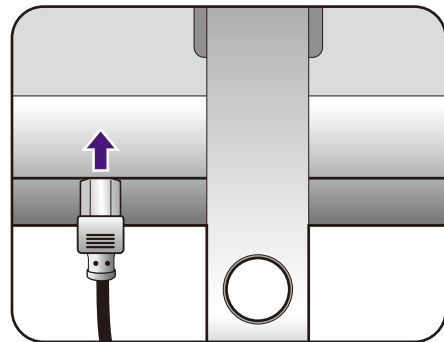

8. Organize the cables.

Route the cables via the cable management hole.

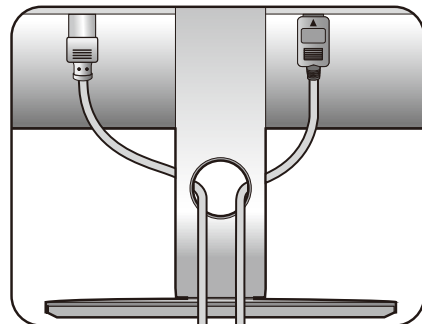

9. Connect-to and turn-on the power.

Plug the other end of the power cord into a power outlet and turn it on.



Picture may differ from product supplied for your region.

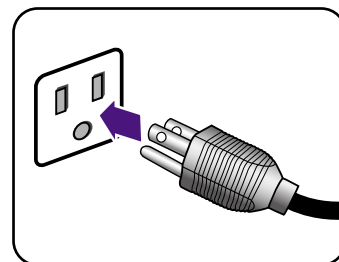

10. Remove the quick start guide from the screen surface.

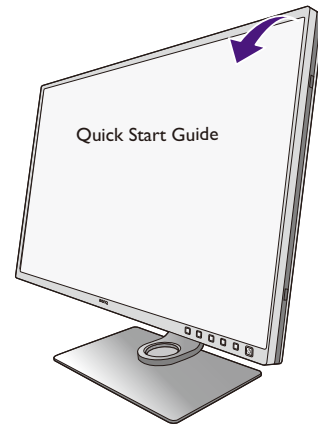

Turn on the monitor by pressing the power button on the monitor.

Turn on the computer too, and follow the instructions in [Getting the most from your BenQ monitor on page 35](#) to install the monitor software.



To extend the service life of the product, we recommend that you use your computer's power management function.

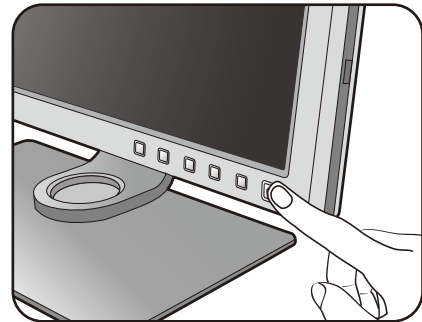



How to detach the stand and the base

1. Prepare the monitor and area.

Turn off the monitor and the power before unplugging the power cable. Turn off the computer before unplugging the monitor signal cable.

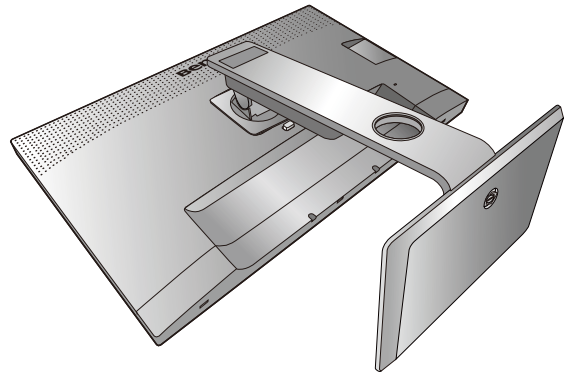
Protect the monitor and screen by clearing a flat open area on your desk and placing a soft item like a towel on the desk for padding, before laying the screen face down on a flat clean padded surface.



-  Please be careful to prevent damage to the monitor. Placing the screen surface on an object like a stapler or a mouse will crack the glass or damage the LCD substrate voiding your warranty. Sliding or scraping the monitor around on your desk will scratch or damage the monitor surround and controls.

2. Remove the monitor stand.

While pressing and holding the quick release button (1), detach the stand from the monitor (2).

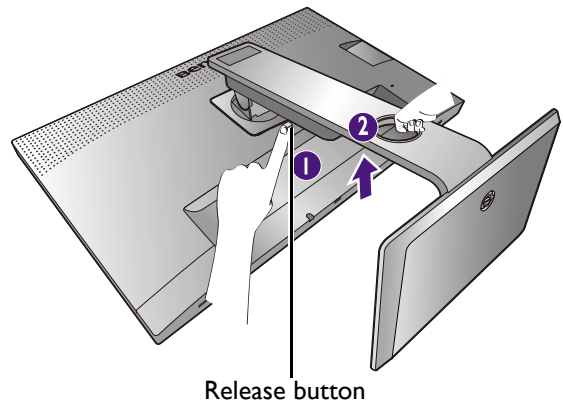

3. Remove the monitor base.

Release the thumbscrew on the bottom of the monitor base.

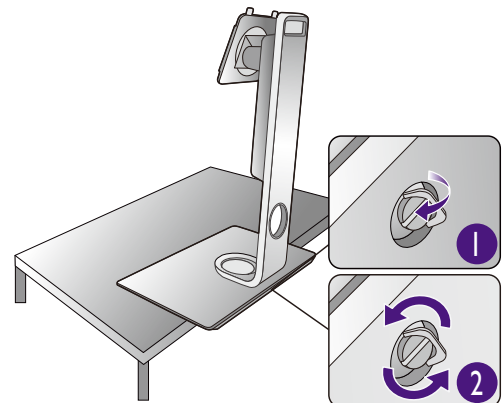

Turn the stand counterclockwise until you cannot go further.

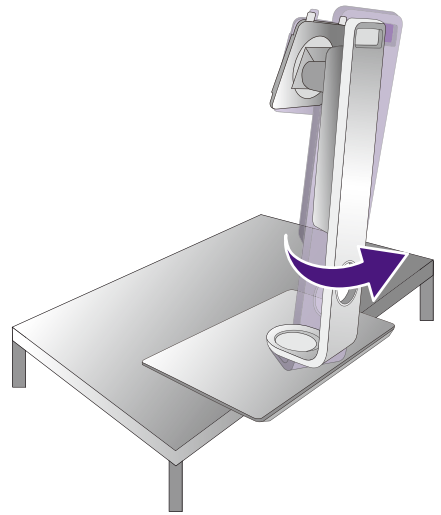

And then detach the base from the stand.

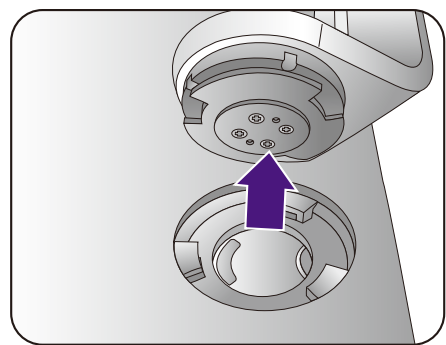

Installing shading hood (optional step)



To prevent glare or most of unwanted reflections from other light sources off your screen, you can install the shading hood (provided or purchased separately, depending on the product supplied for your region).



- Please be careful to prevent damage to the shading hood and the monitor. Different pieces of shading hood are well-designed and can fit into your monitor properly. Do not use excessive force when installing the shading hood to avoid possible damage.

- Avoid finger pressure on the screen surface.

You can find the carved arrows on the inner side of some plates. Refer to the installation requirements and the printed marks to prepare the plates needed for landscape and portrait installation separately.

Landscape installation

Plates required for landscape installation:

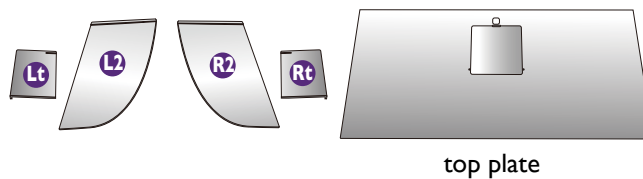

1. Prepare for the shading hood installation.

Place the monitor upright on its stand on a flat even surface. Make sure the monitor is rotated to the landscape mode.

Follow the illustrations to complete the installation carefully.

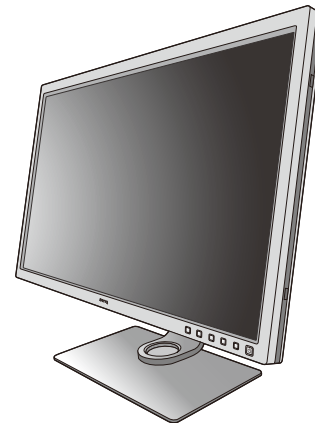

2. Install the right hoods.

Align the arrow on plate (Rt) with the one on plate (R2) and attach them together. Slide plate (Rt) to the end as illustrated.

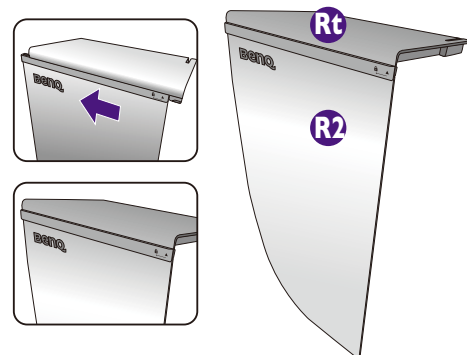

3. Attach to the right side of the monitor.

Align the hooks on the hood (plate R2) with the holes on the right side of the monitor, and insert the hooks. After that, press down plate (Rt) to fix it firmly.

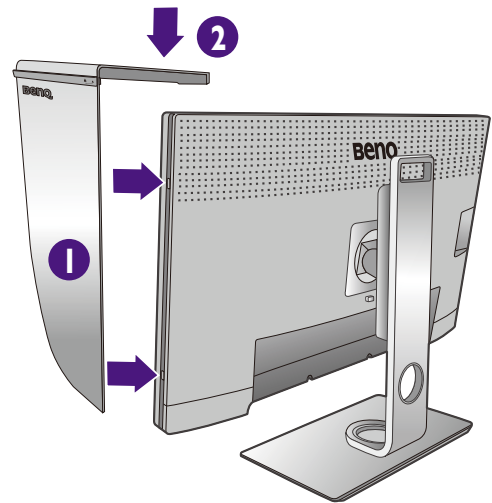

4. Install the left hoods.

Align the arrow on plate (Lt) with the one on plate (L2) and attach them together. Slide plate (Lt) to the end as illustrated.

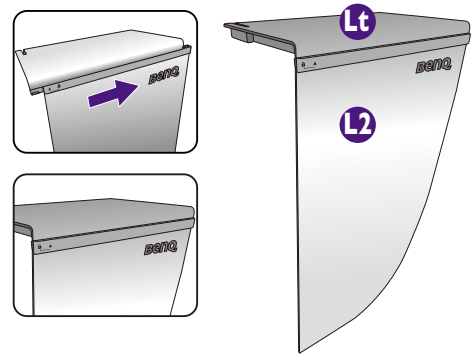

5. Attach to the left side of the monitor.

Align the hooks on the hood (plate L2) with the holes on the left side of the monitor, and insert the hooks. After that, press down plate (Lt) to fix it firmly.

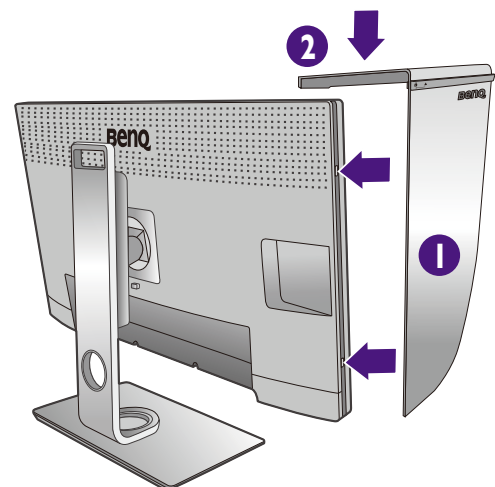

6. Install the top plate.

Hook the top plate on plate (R2) and plate (L2) as illustrated, and insert the top plate to the notch on the top of the other plates.

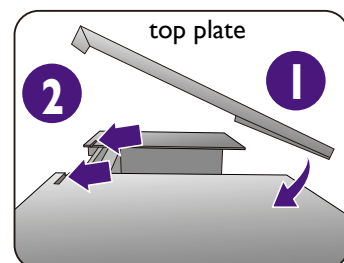

7. If you intend to calibrate the display's color by a colorimeter, slide to open the cover on the top plate so the colorimeter can be installed.



Follow the instruction manuals of the colorimeter you purchased and the provided software (e.g., **Palette Master Element**) to complete the installation and calibration process.

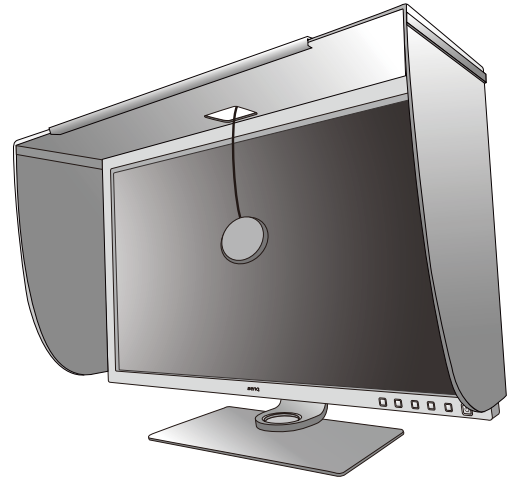

Portrait installation

Plates required for portrait installation:

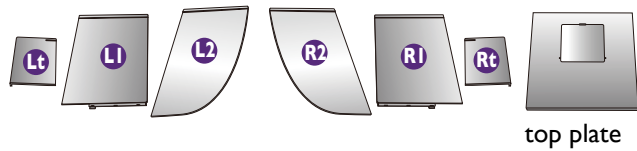

1. Prepare for the shading hood installation.

Place the monitor upright on its stand on a flat even surface. Make sure the monitor is rotated to the portrait mode as instructed in [Rotating the monitor on page 32](#).

Follow the illustrations to complete the installation carefully.



2. Install the right hoods.

Align the arrow on plate (R1) with the one on plate (R2) and attach them together. Slide plate (R2) to the end as illustrated.

Align the arrow on plate (Rt) with the one on plate (R1) and attach them together. Slide plate (R1) along with plate (R2) to the end as illustrated.

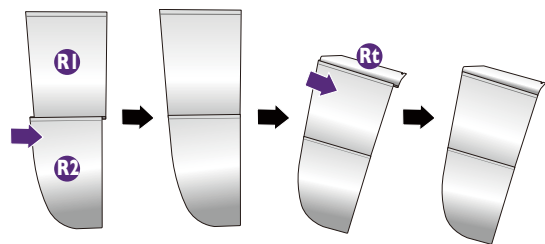

3. Attach to the right side of the monitor.

Align the hooks on the hood with the holes on the right side of the monitor, and insert the hooks. After that, press down plate (Rt) to fix it firmly.

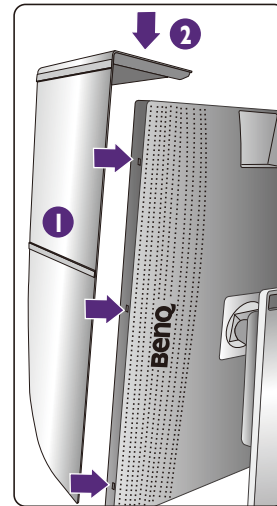

4. Install the left hoods.

Align the arrow on plate (L1) with the one on plate (L2) and attach them together. Slide plate (L2) to the end as illustrated.

Align the arrow on plate (Lt) with the one on plate (L1) and attach them together. Slide plate (L1) along with plate (L2) to the end as illustrated.

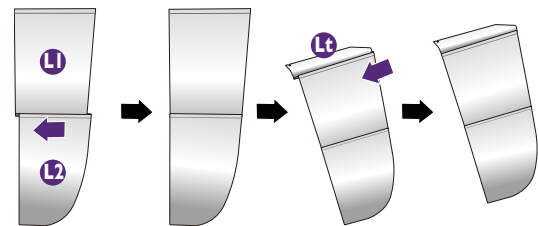

5. Attach to the left side of the monitor.

Align the hooks on the hood with the holes on the left side of the monitor, and insert the hooks. After that, press down plate (Lt) to fix it firmly.

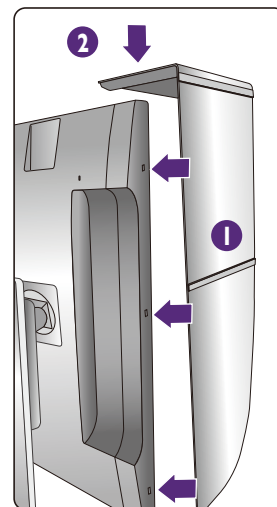

6. Install the top plate.

Hook the top plate on plate (R2) and plate (L2) as illustrated, and the top plate to the notch on the top of the other plates.

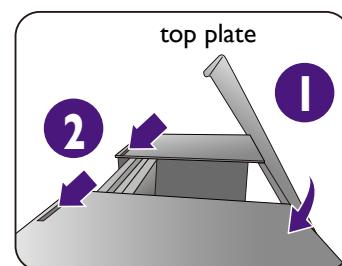

7. If you intend to calibrate the display's color by a colorimeter, slide to open the cover on the top plate so the colorimeter can be installed.



Follow the instruction manuals of the colorimeter you purchased and the provided software (e.g., **Palette Master Element**) to complete the installation and calibration process.

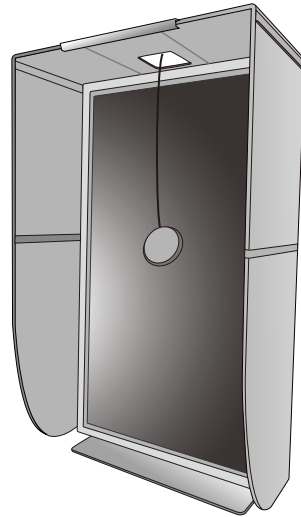

Adjusting the monitor height

To adjust the monitor height, hold both the left and the right sides of the monitor to lower the monitor or lift it up to the desired height.

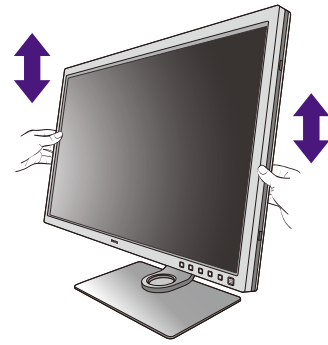

- Avoid placing hands on the upper or lower part of the height-adjustable stand or at the bottom of the monitor, as ascending or descending monitor might cause personal injuries. Keep children out of reach of the monitor while performing this operation.

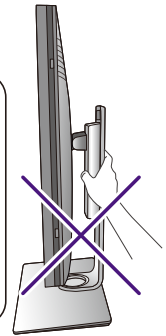
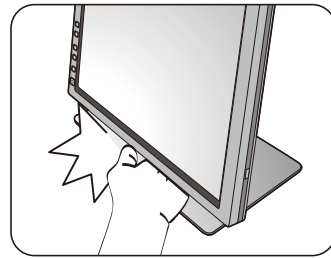

- If the monitor has been rotated to portrait mode and height adjustment is desired, you should be noted that the wide screen will keep the monitor from being lowered to its minimum height. Pay attention not to hit the Hotkey Puck G2.



Rotating the monitor

 Rotate the monitor before installing the shading hood. See [Portrait installation on page 28](#) for more information.

1. Pivot the display.

Before rotating the monitor with a portrait viewing orientation, the display has to be rotated 90 degrees.

Right-click the desktop and select **Screen resolution** from the popup menu. Select **Portrait in Orientation**, and apply the setting.



Depending on the operating system on your PC, different procedures should be followed to adjust the screen orientation. Refer to the help document of your operating system for details.

2. Fully extend the monitor and tilt it.

Gently lift the display up and extend it to the maximum extended position. Then tilt the monitor.



The monitor should be vertically extended to allow to rotate from landscape to portrait mode.

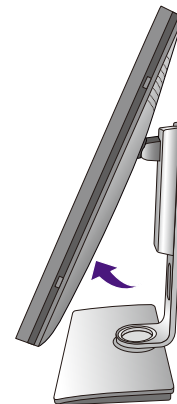
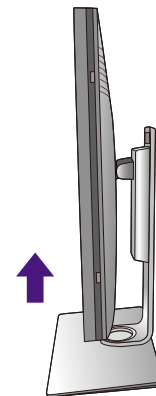

3. Rotate the monitor 90 degrees clockwise as illustrated.



To avoid the edge of the LCD display hitting the monitor base surface while it is being rotated, do tilt and extend the monitor to the highest position before you start to rotate the display. You should also make sure there are no obstacles around the monitor and there is enough room for cables. Remove the connected USB peripherals and audio cable first.

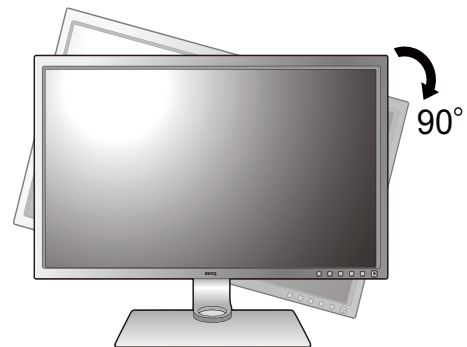

4. Adjust the monitor to the desired viewing angle.



Viewing angle adjustment

You may position the screen to the desired angle with monitor tilt, swivel, and height adjustment functions. Check the product specifications on the website for details.

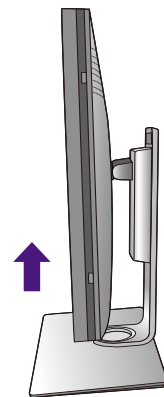
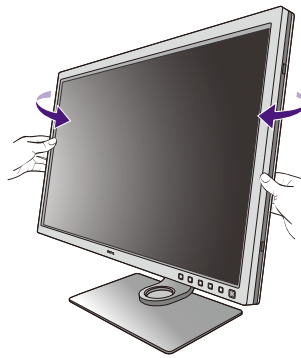
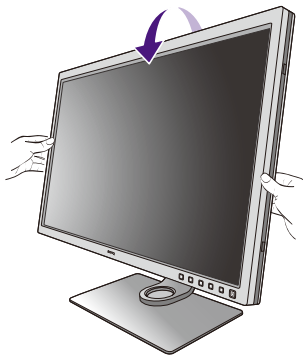

Using the monitor wall mounting kit

The back of your LCD monitor has a VESA standard mount with 100mm pattern, allowing the installation of a wall mount bracket. Before starting to install a monitor wall mounting kit, please read the precautions carefully.

Precautions

- Install your monitor and monitor mounting kit on a wall with flat surface.
- Ensure that the wall material and the standard wall mount bracket (purchased separately) are stable enough to support the weight of the monitor. Refer to the product specifications on the website for weight information.
- Turn off the monitor and the power before disconnecting the cables from the LCD monitor.

1. Remove the monitor stand.

Lay the screen face down on a clean and well-padded surface. Detach the monitor stand as instructed in step 1~2 in [How to detach the stand and the base on page 24](#).

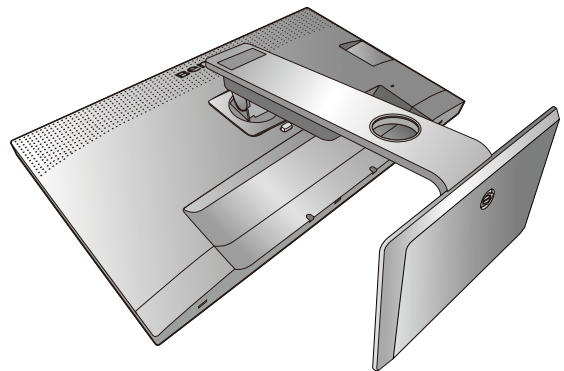

2. Remove the screws on the back cover.

Use a cross-pointed screwdriver to release the screws on the back cover. The use of a magnetic-head screwdriver is recommended to avoid losing the screws.

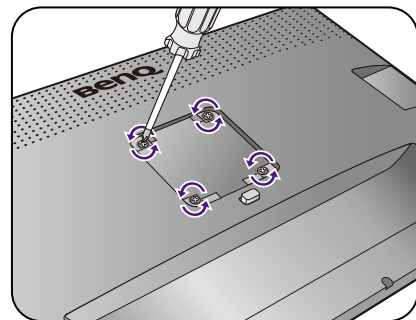

In case you intend to use your monitor on the stand in the future, please keep the monitor base, monitor stand, and screws somewhere safe for future use.

3. Follow the instruction manuals of the wall mount bracket you purchased to complete the installation.



Use four M4 x 10 mm screws to fix a VESA standard wall mount bracket to the monitor. Make sure that all screws are tightened and secured properly. Consult a professional technician or BenQ service for wall mount installation and safety precautions.

Getting the most from your BenQ monitor

To gain the most benefit from your new BenQ LCD monitor, you should install the custom BenQ LCD Monitor driver software as provided on the local website. See [Downloading the LCD Monitor driver files from the Internet on page 35](#) for details.

The circumstances under which you connect and install your BenQ LCD Monitor will determine which process you need to follow to successfully install the BenQ LCD Monitor driver software. These circumstances relate to which version of Microsoft Windows you are using, and whether you are connecting the monitor and installing the software onto a new computer (without existing monitor driver software), or whether you are upgrading an existing installation (which already has existing monitor driver software) with a newer monitor.

In either case however, the very next time you turn on your computer (after connecting the monitor to your computer), Windows will automatically recognize the new (or different) hardware, and will launch its **Found New Hardware wizard**.

Follow the wizard instructions. Further details and step-by-step instructions for either an automatic (new) or upgrade (existing) installation, see:

- [How to install the monitor on a new computer on page 36](#).
- [How to upgrade the monitor on an existing computer on page 37](#).



- If you require a User Name and Password to login to your Windows computer, you must be logged on as an Administrator or as a member of the Administrators group in order to install the monitor driver software. Furthermore, if your computer is connected to a network which has security access requirements, network policy settings may prevent you from installing software on your computer.
 - To check the name of the purchased model, refer to the specification label on the back of the monitor.
-

Downloading the LCD Monitor driver files from the Internet

1. Download the correct driver files from www.BenQ.com > **Support** > **Download & FAQ** > model name > **Software**.
2. On your computer, have your driver files extracted into an empty folder. Remember the file location the files are extracted to.

How to install the monitor on a new computer

This instruction details the procedure for selecting and installing the BenQ LCD Monitor driver software on a new computer which has never had a monitor driver installed before. This instruction is only suitable for a computer which has never been used before, and for which the BenQ LCD Monitor is the first ever monitor to be connected to it.



If you are adding the BenQ LCD Monitor to an existing computer that has already had another monitor connected to it (and has monitor driver software installed), you should not be following these instructions. You should instead be following the instructions for [How to upgrade the monitor on an existing computer](#).

1. Follow the instructions in [How to assemble your monitor hardware on page 18](#).
When Windows starts, it will automatically detect the new monitor and launch the **Found New Hardware Wizard**. Follow the prompts until it displays the option to **Install Hardware Device Drivers**.
2. Check **Search for a suitable driver for my device** option, and click **Next**.
3. Look to confirm that the wizard has selected the correct name of your monitor and click **Next**.
4. Click **Finish**.
5. Restart the computer.

How to upgrade the monitor on an existing computer

This instruction details the procedure for manually updating the existing monitor driver software on your Microsoft Windows computer. It is currently tested as compatible for Windows 10, Windows 8 (8.1), and Windows 7 Operating System (OS).



The BenQ LCD Monitor driver for your model may well function perfectly with other versions of Windows, however, as at the time of writing, BenQ has done no testing of this driver on other versions of Windows and cannot guarantee its operation on those systems.

Installing monitor driver software involves selecting an appropriate information file (.inf) from the downloaded driver files for the particular model monitor you have connected, and letting Windows install the corresponding driver files. You need only steer it in the right direction. Windows has an Upgrade Device Driver Wizard to automate the task and guide you through the file selection and installation process.

See:

- [How to install on Windows 10 system on page 38](#)
- [How to install on Windows 8 \(8.1\) system on page 39](#)
- [How to install on Windows 7 system on page 40.](#)

How to install on Windows 10 system

1. Open **Display Properties**.

Go to **Start, Settings, Devices, Devices and Printers** and right-click the name of your monitor from the menu.

2. Select **Properties** from the menu.

3. Click the **Hardware** tab.

4. Click **Generic PnP Monitor**, and then the **Properties** button.

5. Click the **Driver** tab and the **Update Driver** button.

6. In the **Update Driver Software** window, select the option **Browse my computer for driver software**.

7. Click **Browse** and locate the driver files downloaded from the Internet as instructed in [Downloading the LCD Monitor driver files from the Internet on page 35](#).

8. Click **Close**.

You may be prompted to restart your computer after the driver update is complete.

How to install on Windows 8 (8.1) system

1. Open **Display Properties**.

Move the cursor to the lower-right of the screen or press the **Windows + C** buttons on the keyboard to bring up the **Charm** bar. Go to **Settings, Control Panel, Devices and Printers** and right-click the name of your monitor from the menu.

Alternatively, right-click the desktop and select **Personalize, Display, Devices and Printers**, and right-click the name of your monitor from the menu.

2. Select **Properties** from the menu.

3. Click the **Hardware** tab.

4. Click **Generic PnP Monitor**, and then the **Properties** button.

5. Click the **Driver** tab and the **Update Driver** button.

6. In the **Update Driver Software** window, select the option **Browse my computer for driver software**.

7. Click **Browse** and locate the driver files downloaded from the Internet as instructed in [Downloading the LCD Monitor driver files from the Internet on page 35](#).

8. Click **Close**.

You may be prompted to restart your computer after the driver update is complete.

How to install on Windows 7 system

1. Open **Display Properties**.

Go to **Start, Control Panel, Hardware and Sound, Devices and Printers** and right-click the name of your monitor from the menu.

Alternatively, right-click the desktop and select **Personalize, Display, Devices and Printers**, and right-click the name of your monitor from the menu.

2. Select **Properties** from the menu.

3. Click the **Hardware** tab.

4. Click **Generic PnP Monitor**, and then the **Properties** button.

5. Click the **Driver** tab and the **Update Driver** button.

6. In the **Update Driver Software** window, select the option **Browse my computer for driver software**.

7. Click **Browse** and locate the driver files downloaded from the Internet as instructed in [Downloading the LCD Monitor driver files from the Internet on page 35](#).

8. Click **Close**.

You may be prompted to restart your computer after the driver update is complete.

How to adjust your monitor

The control panel

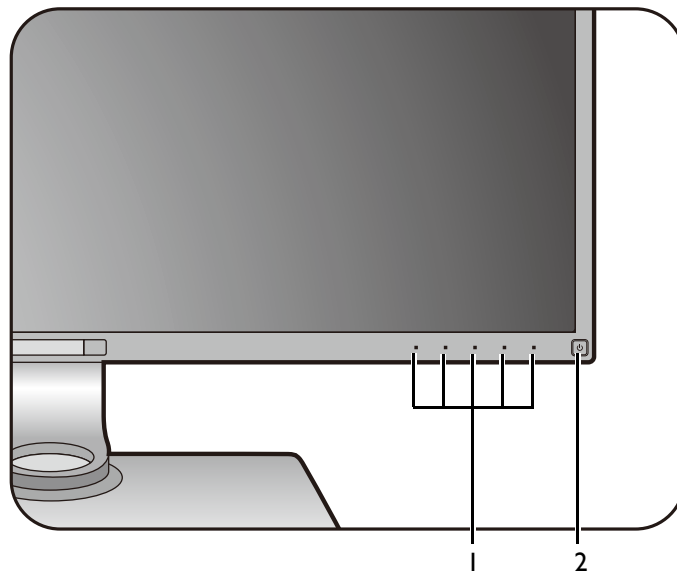

No.	Name	Description
1.	Control keys	Accesses the functions or menu items displayed on the screen, right next to each key.
2.	Power key	Turns the power on or off.

Hotkey Puck G2 and its basic operations

Apart from the control keys, Hotkey Puck G2 also provides a quick way to control and access the OSD menu.



- You need to connect the Hotkey Puck G2 to your monitor prior to use. Follow the instructions in [Connect the Hotkey Puck G2 to the monitor](#) on page 21.
- Hotkey Puck G2 is designed for BenQ LCD Monitor exclusively and is available for compatible models only. Do not connect it to other devices with mini USB ports.

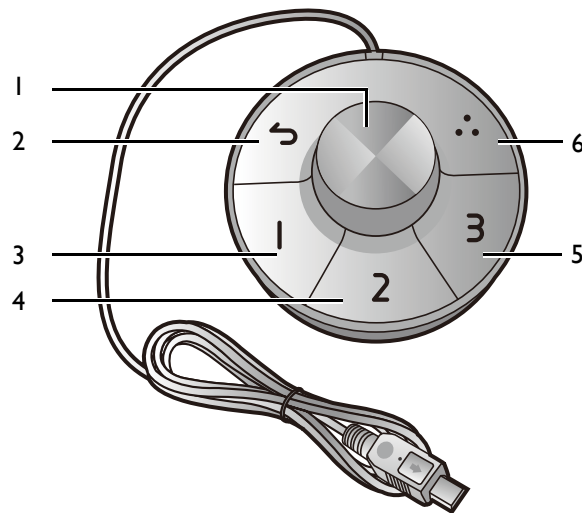

No.	Name	Description
1	Dial key	<p>(If no menu is displayed)</p> <ul style="list-style-type: none"> Turn right or left to adjust Brightness by default. To change the default settings, press and hold for 3 seconds to bring up the setup menu to change the default setting. Alternatively, go to Controller Key > Controller Key Dial on the monitor. Press to bring up the main menu. <p>(On a menu)</p> <ul style="list-style-type: none"> Turn right to scroll down the menu. Turn left to scroll up the menu. Press to confirm the selection. <p>(If a control bar is displayed)</p> <ul style="list-style-type: none"> Turn right to increase the value. Turn left to decrease the value.
2	Return key	<ul style="list-style-type: none"> Returns to the previous menu. Exits OSD menu.
3	Controller Key I	<ul style="list-style-type: none"> Press to switch to Adobe RGB (Color Mode) by default. Press and hold for 3 seconds to bring up the setup menu to change the default setting. Alternatively, see Customizing the Controller Keys on Hotkey Puck G2 on page 43.

No.	Name	Description
4	Controller Key 2	<ul style="list-style-type: none"> • Press to switch to sRGB (Color Mode). • Press and hold for 3 seconds to bring up the setup menu to change the default setting. Alternatively, see Customizing the Controller Keys on Hotkey Puck G2 on page 43.
5	Controller Key 3	<ul style="list-style-type: none"> • Press to switch to B+W (Color Mode). • Press and hold for 3 seconds to bring up the setup menu to change the default setting. Alternatively, see Customizing the Controller Keys on Hotkey Puck G2 on page 43.
6	Rotation Key	<ul style="list-style-type: none"> • Press repeatedly to cycle through available settings. • Press and hold for 3 seconds to bring up the setup menu to change the default setting. Alternatively, go to Controller Key > Rotation Key on the monitor.

Customizing the Controller Keys on Hotkey Puck G2

Keys on the Hotkey Puck G2 are designated for particular functions. You can change the default settings as desired.

1. Press any of the control keys to bring up the hot key menu.
2. Select  (**Menu**) to access the main menu.
3. Go to **Controller Key**.
4. Select **Controller Key 1, 2, 3**.
5. On the sub menu, select a category.
6. Under the category, check to select up to 3 items for quick access by the Controller Keys on Hotkey Puck G2. The numbers displayed by the chosen items refer to the Controller Keys that the options are assigned to.



Alternatively, press and hold a key on the Hotkey Puck G2 for 3 seconds to bring up the setup menu to change the default setting.

Basic menu operation

All OSD (On Screen Display) menus can be accessed by the control keys. You can use the OSD menu to adjust all the settings on your monitor.

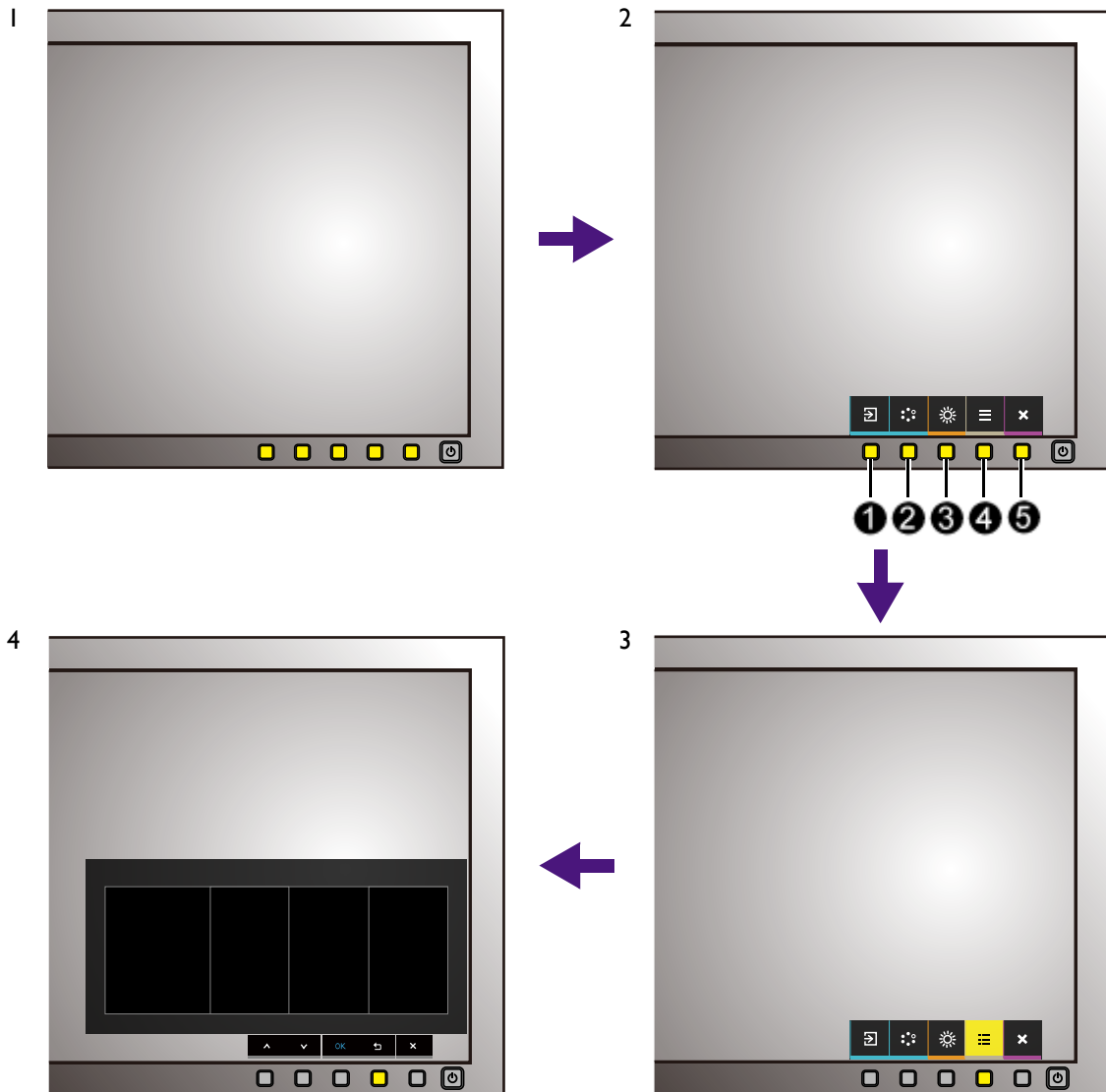

1. Press any of the control keys.
2. The hot key menu is displayed. The left three controls are custom keys and are designated for particular functions.
3. Select  (**Menu**) to access the main menu.
4. In the main menu, follow the icons next to the control keys to make adjustments or selection. See [Navigating the main menu on page 49](#) for details on the menu options.

No.	OSD in hot key menu	OSD icon in main menu	Function
①	Custom Key 1	^	<ul style="list-style-type: none"> • By default, the key is the hot key for Input. To change the default settings, see Customizing the hot keys on page 45. • For Up/Increase adjustment.

No.	OSD in hot key menu	OSD icon in main menu	Function
②	Custom Key 2	∨	<ul style="list-style-type: none"> • By default, the key is the hot key for Color Mode. To change the default settings, see Customizing the hot keys on page 45. • For Down/Decrease adjustment.
③	Custom Key 3	→ / OK	<ul style="list-style-type: none"> • By default, the key is the hot key for Brightness. To change the default settings, see Customizing the hot keys on page 45. • Enters sub menus. • Selects menu items.
④	Menu	↶	<ul style="list-style-type: none"> • Activates the main menu. • Returns to the previous menu.
⑤	Exit	✕	Exits OSD menu.



- OSD = On Screen Display.
- The hot keys only operate while the main menu is not currently displaying. Hot key displays will disappear after a few seconds of no key activity.
- To unlock the OSD controls, press and hold any key for 10 seconds.

Customizing the hot keys

The left 3 control keys (also called custom keys) perform as hot keys to provide direct access to pre-defined functions. You can change the default setting and designate different functions for these keys.

1. Press any of the control keys to bring up the hot key menu. Select  (**Menu**) to access the main menu.
2. Go to **System**.
3. Select the custom key you want to change.
4. In the sub menu, select a function that can be accessed by this key. A pop-up message will appear, showing that the setup is complete.



Apart from the control keys on the monitor, the controller key 1/2/3 on the Hotkey Puck G2 work as hot keys as well. Press and hold one of the controller key (1/2/3) for 5 seconds to bring up a list of options, select another feature of setup menu by pressing ▲ or ▼, and confirm with OK. See [Customizing the Controller Keys on Hotkey Puck G2 on page 43](#) for more information.

Working with HDR technology



- Your monitor supports HDR10 and HLG technologies.
- The information regarding HDR-compatible devices and content in this document is most up-to-date at the time of publication. For the latest information, contact your device manufacturer and content provider.

To enable HDR function, you need to have a compatible player and content.

1. Make sure a 4K HDR player is ready. Players with the following names and resolutions are supported.

Commonly used names for 4K (may vary by manufacturer)	4K, 4K Ultra HD, UHD, UHD 4K, Ultra HD, 2160p
Supported resolution or modes	3840 x 2160 @ 60 Hz
Commonly used names for HDR10 (may vary by manufacturer)	HDR Premium, High Dynamic Range, HDR, Ultra HD Premium
Commonly used name for HLG (may vary by manufacturer)	Hybrid Log Gamma

2. Make sure HDR content is available. Content may come from 4K UHD (Blue-Ray) or new HDR games on Xbox One S and PS4 Pro.
3. Make sure the player and the monitor have been connected via an appropriate cable:
 - the provided HDMI / DP / DP to mini DP cable / USB-C™ cable (if available)
 - an HDMI cable that is HDMI High Speed or HDMI Premium certified (for models with HDMI inputs)
 - a DP / DP to mini DP cable that is DisplayPort compliance certified (for models with DP inputs)
 - a certified USB-C™ cable (for models with USB-C™ inputs)

Enabling HDR function

If the instructions in [Working with HDR technology on page 45](#) are followed and the input content is HDR-compatible, the OSD message **HDR: On** is displayed on the screen. This means your content player and content are HDR-compatible and the HDR function is properly enabled. Depending on the input signal, the monitor detects whether it is HDR10 or HLG content and process the content properly.

If the connection is complete and no OSD message is displayed, this means the content player and/or the content are not HDR-compatible. The monitor stays to the picture mode recently chosen for non-HDR content.

Adjusting the display color

To adjust the display color, you can do one of the following:

- Apply the standard color setting from **Color Adjustment > Color Mode**.
- Change the display and color settings manually from the related OSD menus. Depending on the **Color Mode** you just set, the available options for color adjustment may vary. Once the adjustment is done, you can save the customized settings from **Color Adjustment > Save Color Settings**.
- Use a colorimeter (purchased separately) to work with the provided software named **Palette Master Element** and optimized the display color. Visit the website for software download and more information (Palette Master Element How-to-Use Guide). See [Appendix: Advanced software on page 68](#).
- To apply the calibrated result, go to **Color Adjustment > Color Mode > calibration modes**.

Adjusting display mode

To display images of aspect ratio other than 16:9 and size other than the panel size of your purchased model, you can adjust the display mode on the monitor.

1. Press any of the control keys to bring up the hot key menu. Select  (**Menu**) to access the main menu.
2. Go to **Display** and **Aspect Ratio**.
3. Select an appropriate display mode. The setting will take effect immediately.

Choosing an appropriate picture mode

Your monitor provides various picture modes that are suitable for different types of images. See [Color Mode on page 53](#) for all the available picture modes.

Go to **Color Adjustment** and **Color Mode** for a desired picture mode.

Video source selection in PIP/PBP mode

Your monitor scans for the available video sources in the following order: HDMI, DP, and USB-C™, and displays the first available one. This video source will become the main source in PIP/PBP mode. You will need to decide the second source for PIP/PBP mode from the menu in [PIP/PBP Source on page 58](#). Menu options that are not available will become grayed out.

Refer to the following table to find your main source and its supporting second sources.

		Possible second sources			
		HDMI-1	HDMI-2	DP	USB-C™
Main source	Inputs				
	HDMI-1	✓	✓	✓	✓
	HDMI-2	✓	✓	✓	✓
	DP	✓	✓	✓	✓
USB-C™	✓	✓	✓	✓	

Minimizing the color difference between the screen and the hardcopy (Paper Color Sync)

Your monitor features Paper Color Sync technology that helps minimize the color difference between the monitor and the hardcopy printed by the connected printer. Once the printing result is predictable on the screen, you can retouch the image efficiently.

No additional software is required if you are working exactly with the following:

- Printer: Canon PIXMA PRO-I0
 - Paper: Canon Photo Paper Pro Luster
 - Color gamut of the image to be printed: sRGB (the information is usually available in the image properties)
1. Make sure the specified printer, paper, and the images are ready.
If you cannot meet the above requirements, you will need the software solution **Paper**

Color Sync, which supports more printers, papers, and color gamuts. See [Appendix: Advanced software on page 68](#) for more information.

2. Go to **Color Adjustment** and **Color Mode**.
3. Select **Paper Color Sync**. And then you can retouch the images as desired or print the images.

Navigating the main menu

You can use the OSD (On Screen Display) menu to adjust all the settings on your monitor.

Press any of the control keys to bring up the hot key menu. Select  (**Menu**) to access the main menu. See [Basic menu operation on page 44](#) for details.

Available menu options may vary depending on the input sources, functions and settings. Menu options that are not available will become grayed out. And keys that are not available will be disabled and the corresponding OSD icons will disappear. For models without certain functions, their settings and related items will not appear on the menu.



The OSD menu languages may differ from the product supplied to your region, see [Language on page 60](#) under **System** and **OSD Settings** for more details.

For more information on each menu, please refer to the following pages:

- [Display menu on page 50](#)
- [Color Adjustment menu on page 52](#)
- [PIP/PBP menu on page 57](#)
- [System menu on page 59](#)
- [Controller Key menu on page 63](#)

Display menu

Available menu options may vary depending on the input sources, functions and settings. Menu options that are not available will become grayed out. And keys that are not available will be disabled and the corresponding OSD icons will disappear. For models without certain functions, their settings and related items will not appear on the menu.

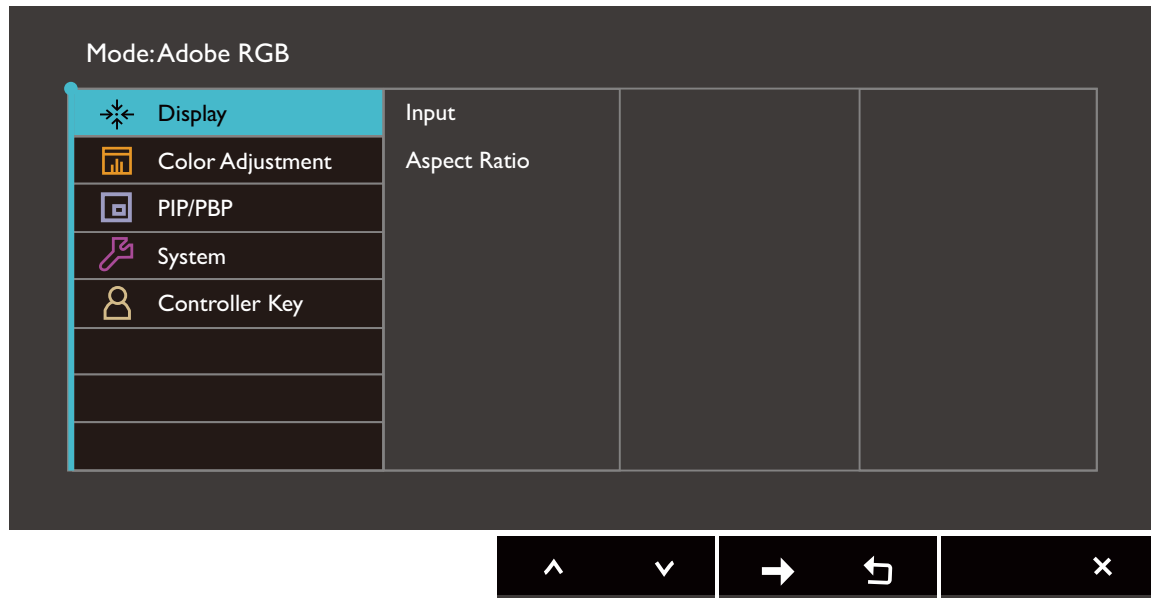

1. Select  (**Menu**) from the hot key menu.
2. Use \wedge or \vee to select **Display**.
3. Select \rightarrow to go to a sub menu, and then use \wedge or \vee to select a menu item.
4. Use \wedge or \vee to make adjustments, or use **OK** to make selection.
5. To return to the previous menu, select \leftarrow .
6. To exit the menu, select \times .









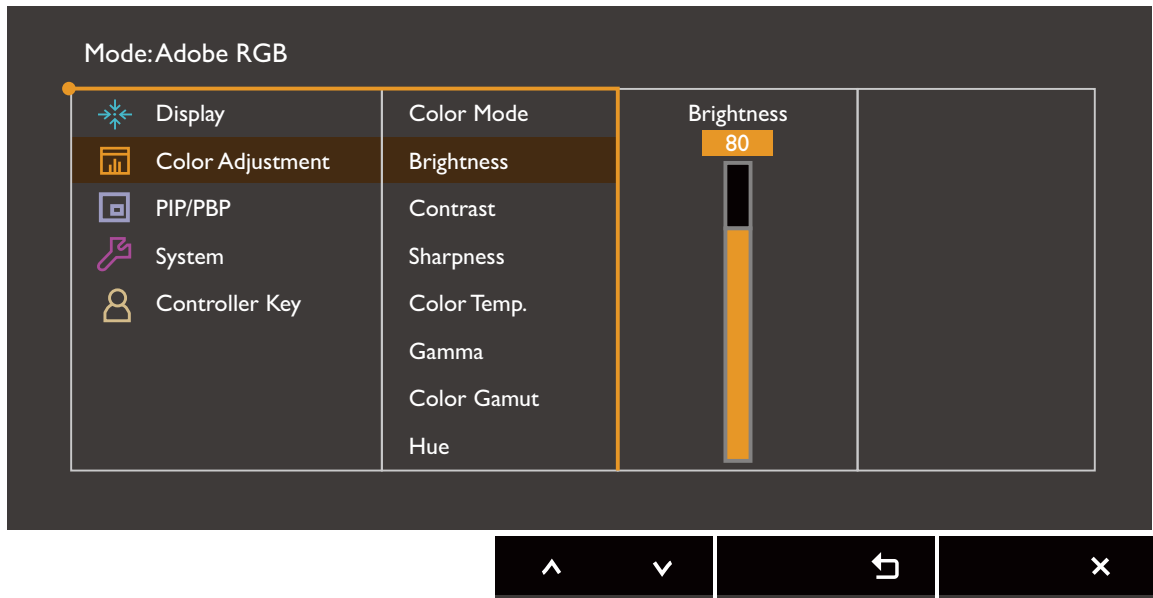

Item	Function	Range
Input	Use this to change the input to that appropriate to your video cable connection type.	<ul style="list-style-type: none">•HDMI-1•HDMI-2•DP•USB-C

Item	Function		Range
Aspect Ratio	This feature is provided to allow aspect ratios other than 16:9 to be displayed without geometric distortion.		
	Full	Scales the input image to fill the screen. Ideal for 16:9 aspect images.	
	Aspect	The input image is displayed without geometric distortion filling as much of the display as possible.	
	1:1	Displays the input image in its native resolution without scaling.	

Color Adjustment menu



Available menu options may vary depending on the input sources, functions and settings. Menu options that are not available will become grayed out. And keys that are not available will be disabled and the corresponding OSD icons will disappear. For models without certain functions, their settings and related items will not appear on the menu.



1. Select  (**Menu**) from the hot key menu.
2. Use  or  to select **Color Adjustment**.
3. Select  to go to a sub menu, and then use  or  to select a menu item.
4. Use  or  to make adjustments, or use **OK** to make selection.
5. To return to the previous menu, select .
6. To exit the menu, select .

Item	Function		Range
Color Mode	Select a color mode that best suits the type of images shown on the screen.		
	Adobe RGB	For better color matching representation with Adobe® RGB compatible peripherals.	
	sRGB	For better color matching representation with sRGB compatible peripherals.	
	B+W	Applies a black and white theme.	<ul style="list-style-type: none"> • Level 1 • Level 2 • Level 3
	Rec. 709	For better color matching representation with Standard Rec. 709.	
	DCI-P3	For better color matching representation with Standard DCI-P3.	
	Display P3	For better color matching representation with Standard Display-P3.	
	M-book	Minimizes the visual differences between the monitor and the connected MacBook series product.	
	HDR	For better color matching representation with High Dynamic Range (HDR) technology.	
	DICOM	<p>For viewing DICOM images. It is recommended for displaying medical images.</p>  <p>DICOM as the abbreviation of Digital Imaging and Communications in Medicine is a standard for handling, storing, printing, and transmitting medical images.</p>	
	Paper Color Sync	Minimizes the color difference between the monitor and the hardcopy. It works with the Paper Color Sync software to simulate the display colors with the selected printers and paper stocks. See Minimizing the color difference between the screen and the hardcopy (Paper Color Sync) on page 47 for more information.	

Item	Function		Range
	Calibration 1	Applies the calibration result optimized by the provided calibration software named Palette Master Element and your colorimeter (purchased separately). Visit the website for software download and more information (Palette Master Element How-to-Use Guide). See Appendix: Advanced software on page 68 .	
	Calibration 2		
	Calibration 3		
	Custom	Applies a combination of color settings defined by users.	
Brightness	Adjusts the balance between light and dark shades.		0 to 100
Contrast	Adjusts the degree of difference between darkness and lightness.		0 to 100
Sharpness	Adjusts the clarity and visibility of the edges of the subjects in the image.		0 to 10
Color Temp.	5000K	Applies a color tint (cool or warm) to the image. Color temperature is measured in K (Kelvin) degrees. The display becomes reddish if the color temperature is low, and becomes bluish if the color temperature is high.  Some color gradations may not be displayed well if this the setting has been adjusted.	
	6500K		
	9300K		
	Custom	Allows to adjust color temperature by 100K.	5000K ~ 9300K
	User Define	The blend of the Red, Green and Blue primary colors can be altered to change the color tint of the image. Go to the succeeding R (red), G (green), and B (blue) menus to change the settings. Decreasing one or more of the colors will reduce their respective influence on the color tint of the image. (e.g. if you reduce the Blue level the image will gradually take on a yellowish tint. If you reduce Green, the image will become a magenta tint.)	<ul style="list-style-type: none"> • R (0~100) • G (0~100) • B (0~100)
Gamma	Adjusts the tone luminance.		<ul style="list-style-type: none"> • 1.6 • 1.8 • 2.0 • 2.2 • 2.4 • 2.6 • sRGB

Item	Function		Range
Color Gamut	Adobe RGB	Suitable for Adobe® RGB compatible peripherals.	
	sRGB	Suitable for sRGB compatible peripherals.	
	Rec. 709	For better color matching representation with Standard Rec. 709.	
	DCI-P3	For better color matching representation with Standard DCI-P3.	
Hue	Adjusts the degree of how we perceive colors.  Some color gradations may not be displayed well if this the setting has been adjusted.		<ul style="list-style-type: none"> • R • G • B • C • M • Y
Saturation	Adjusts the purity degree of colors.  Some color gradations may not be displayed well if this the setting has been adjusted.		<ul style="list-style-type: none"> • R • G • B • C • M • Y
Black Level	Adjusts the luminance of the dark areas in an image.		0~10
Save Color Settings	Saves a new set of customized color settings.		Custom Mode
Reset Color	Resets the custom color settings to the factory defaults.		<ul style="list-style-type: none"> • YES • NO

Available menu options for each color mode

Depending on the **Color Mode** you just set, the available options for color adjustment may vary. Color modes and the available display options are as follows:

Color Mode	Settings								
	Brightness	Contrast	Sharpness	Color Temp.	Gamma	Color Gamut	Hue	Saturation	Black Level
Adobe RGB	V	V	V	5000K / 6500K	2.2	Adobe RGB	N/A	N/A	V
sRGB	V	V	V	5000K / 6500K	2.2 / sRGB	sRGB	N/A	N/A	V
B+W (*)	V	V	V	N/A	N/A	N/A	N/A	N/A	N/A
Rec. 709	V	V	V	6500K	2.2 / 2.4	Rec. 709	N/A	N/A	N/A
M-book	V	V	V	N/A	N/A	N/A	N/A	N/A	N/A

SW321C

SW321C		Settings							
Color Mode	Brightness	Contrast	Sharpness	Color Temp.	Gamma	Color Gamut	Hue	Saturation	Black Level
DCI-P3	V	V	V	N/A	2.2 / 2.4 / 2.6	DCI-P3	N/A	N/A	N/A
Display-P3	V	V	V	6500K	sRGB	DCI-P3	N/A	N/A	N/A
DICOM	V	V	V	N/A	N/A	N/A	N/A	N/A	N/A
HDR	V	V	V	N/A	N/A	N/A	N/A	V	N/A
Calibration 1	N/A	N/A	V	N/A	N/A	N/A	V	V	N/A
Calibration 2	N/A	N/A	V	N/A	N/A	N/A	V	V	N/A
Calibration 3	N/A	N/A	V	N/A	N/A	N/A	V	V	N/A
Custom	V	V	V	V	V	V	V	V	V
Paper Color Sync	N/A	N/A	N/A	N/A	N/A	N/A	N/A	N/A	N/A









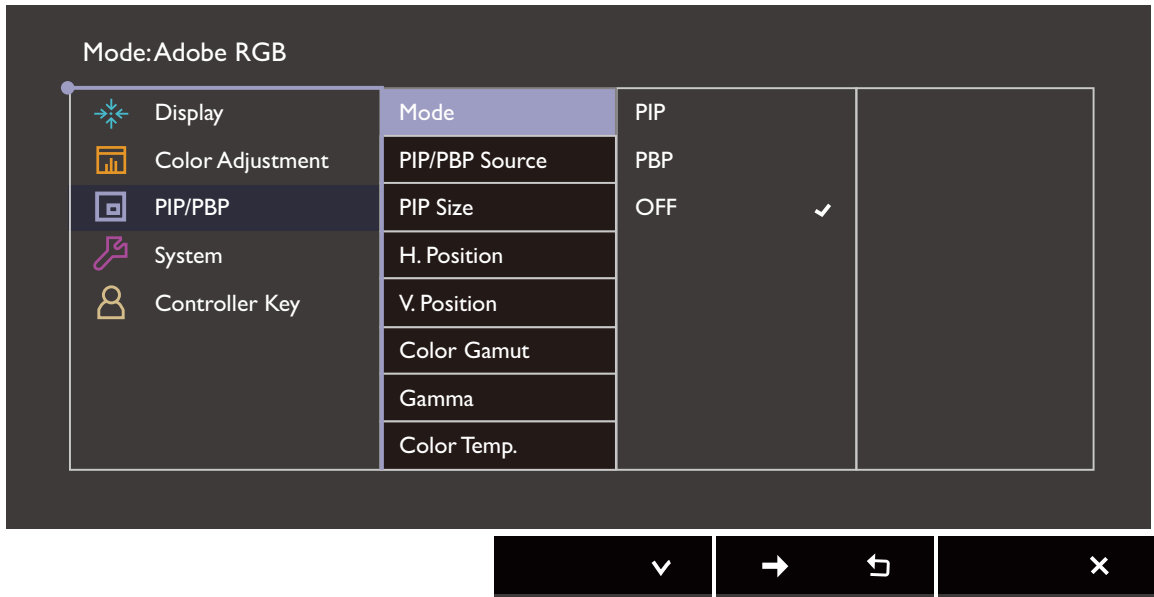



- V: all options are available for adjustment.
- N/A: all options are not available for adjustment.
- *: 3 levels are provided for adjustment.

PIP/PBP menu

Available menu options may vary depending on the input sources, functions and settings. Menu options that are not available will become grayed out. And keys that are not available will be disabled and the corresponding OSD icons will disappear. For models without certain functions, their settings and related items will not appear on the menu.



1. Select  (**Menu**) from the hot key menu.
2. Use  or  to select **PIP/PBP**.
3. Select  to go to a sub menu, and then use  or  to select a menu item.
4. Use  or  to make adjustments, or use **OK** to make selection.
5. To return to the previous menu, select .
6. To exit the menu, select .









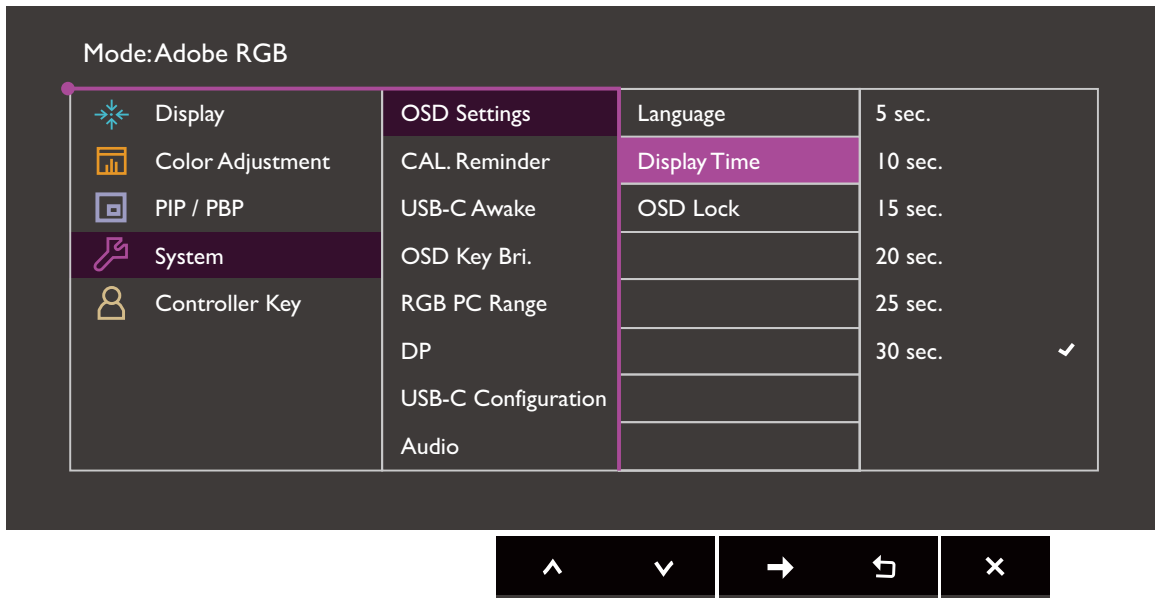

Item	Function		Range
Mode	Sets the PIP or PBP mode. Pictures from two independent video sources are displayed on the screen at the same time.		
	PIP	The Picture-in-Picture (PIP) mode displays the main video source on the screen while the second source in an inset window (sub window).	
	PBP	Allows to display images from two different video sources side-by-side.	
	OFF	Disables PIP/PBP mode.	



Item	Function	Range
PIP/PBP Source	Sets the second video source for the PIP/PBP mode.	<ul style="list-style-type: none"> • HDMI-1 • HDMI-2 • DP • USB-C
PIP Size	Determines the size of the inset window in the PIP mode.	<ul style="list-style-type: none"> • Small • Medium • Large
H. Position	Adjusts the horizontal position of the inset window in the PIP mode.	0~100
V. Position	Adjusts the vertical position of the inset window in the PIP mode.	0~100
Color Gamut	Reproduces the color gamut set by specified standards of the inset window in PBP mode.	<ul style="list-style-type: none"> • Adobe RGB • sRGB • Rec. 709 • DCI-P3
Gamma	Adjusts the tone luminance of the inset window in PBP mode.	<ul style="list-style-type: none"> • 1.6 • 1.8 • 2.0 • 2.2 • 2.4 • 2.6 • sRGB
Color Temp.	Applies a color tint (cool or warm) to the image of the inset window in PBP mode. Color temperature is measured in K (Kelvin) degrees. The display becomes reddish if the color temperature is low, and becomes bluish if the color temperature is high.	<ul style="list-style-type: none"> • 5000K • 6500K • 9300K
Contrast	Adjusts the contrast of the inset window (sub window) in the PIP/PBP mode.	0~100
Sharpness	Adjusts the sharpness of the inset window (sub window) in the PIP/PBP mode.  To adjust the contrast and the sharpness of the main source, go to the Color Adjustment menu. See page 54 for more information.	0~10

System menu

Available menu options may vary depending on the input sources, functions and settings. Menu options that are not available will become grayed out. And keys that are not available will be disabled and the corresponding OSD icons will disappear. For models without certain functions, their settings and related items will not appear on the menu.



1. Select  (**Menu**) from the hot key menu.
2. Use  or  to select **System**.
3. Select  to go to a sub menu, and then use  or  to select a menu item.
4. Use  or  to make adjustments, or use **OK** to make selection.
5. To return to the previous menu, select .
6. To exit the menu, select .

Item	Function		Range
OSD Settings	Language	<p>Sets the OSD menu language.</p>  <p>The language options displayed on your OSD may differ from those shown on the right, depending on the product supplied in your region.</p>	<ul style="list-style-type: none"> • English • Français • Deutsch • Italiano • Español • Polski • Česky • Magyar • Română • Nederlands • Русский • Svenska • Português • العربية • 日本語 • 한국어 • 繁體中文 • 简体中文
	Display Time	Adjusts the display time of the OSD menu.	<ul style="list-style-type: none"> • 5 sec. • 10 sec. • 15 sec. • 20 sec. • 25 sec. • 30 sec.
	OSD Lock	<p>Prevents all the monitor settings from being accidentally changed. When this function is activated, the OSD controls and hotkey operations will be disabled.</p>  <p>To unlock the OSD controls, press and hold any key for 10 seconds.</p>	
CAL. Reminder	Sets to remind you when monitor calibration is recommended. When the monitor is in use, the used time is automatically calculated by a built-in timer.		<ul style="list-style-type: none"> • ON • OFF
USB-C Awake	<p>If this function is disabled, the USB-C™ port is not supplied with power while the monitor is in standby mode.</p> <p>To keep supplying power to the USB-C™ port in monitor's standby mode, change the setting to ON.</p>		<ul style="list-style-type: none"> • ON • OFF

Item	Function		Range
OSD Key Bri.	Adjusts the LED indicator's brightness of the power key.		0 ~ 5
RGB PC Range	Determines the range of color scales. Select an option that matches the RGB range setting on the connected HDMI / DP device.		<ul style="list-style-type: none"> • Auto Detect • RGB (0~255) • RGB (16~235)
DP	Selects an appropriate DP standard for data transmission.		<ul style="list-style-type: none"> • 1.1 • 1.4
USB-C Configuration	Sets the refresh rate of the input video via USB-C™ port. The USB transmission speed changes accordingly due to USB-C™ technology limitation. See Options for data transfer via USB-C™ on page 62 for more information.  Available when the input source is USB-C™.		<ul style="list-style-type: none"> • UHD@60Hz + USB 2.0 • UHD@30Hz + USB 3.1
Audio	Volume	Adjusts the audio volume.	0~100
	Mute	Mutes the audio input.	<ul style="list-style-type: none"> • ON • OFF
AMA	Improves the gray level response time of the LCD panel.		<ul style="list-style-type: none"> • ON • OFF
Auto Power Off	Sets the time to power off the monitor automatically in power saving mode.		<ul style="list-style-type: none"> • OFF • 10 min. • 20 min. • 30 min.
Auto Pivot	Sets to rotate the OSD menu with the monitor.		<ul style="list-style-type: none"> • ON • OFF
Resolution Notice	Sets whether to display the resolution notice of the recommended resolution when a new input source is detected by the monitor.		<ul style="list-style-type: none"> • ON • OFF
Custom Key 1	Sets the function to be accessed by custom key 1.		<ul style="list-style-type: none"> • Brightness • Contrast • Input • Color Mode • Color Temp. • Gamma • Color Gamut • PIP/PBP
Custom Key 2	Sets the function to be accessed by custom key 2.		
Custom Key 3	Sets the function to be accessed by custom key 3.		

Item	Function	Range
DDC/CI	<p>Allows the monitor settings to be set through the software on the PC.</p>  <p>DDC/CI, short for Display Data Channel/Command Interface, which was developed by Video Electronics Standards Association (VESA). DDC/CI capability allows monitor controls to be sent via the software for remote diagnostics.</p>	<ul style="list-style-type: none"> • ON • OFF
Information	Displays the current monitor property settings.	<ul style="list-style-type: none"> • Input • Input bit • Current Resolution • Optimum Resolution (best with the monitor) • HDR • Model Name
Reset All	Resets all mode, color and geometry settings to the factory default values.	<ul style="list-style-type: none"> • YES • NO









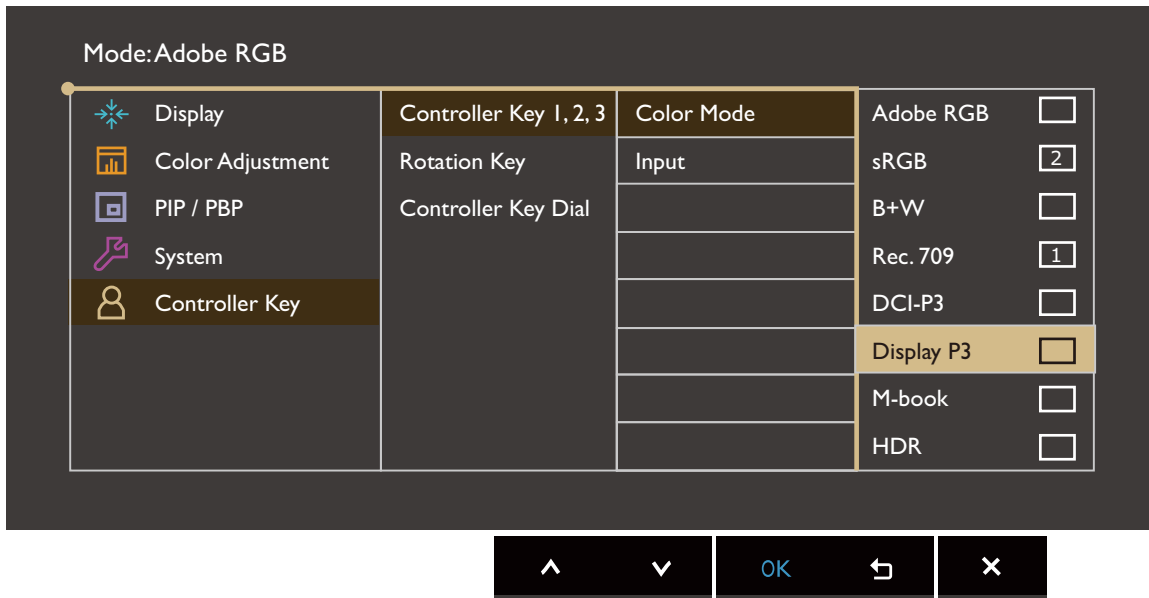

Options for data transfer via USB-C™

SW321C	3840 x 2160@60Hz + USB 2.0	3840 x 2160@30Hz + USB 3.1
Refresh rate	60 Hz	30 Hz
USB transmission speed	480Mbps	5Gbps

Controller Key menu

Available menu options may vary depending on the input sources, functions and settings. Menu options that are not available will become grayed out. And keys that are not available will be disabled and the corresponding OSD icons will disappear. For models without certain functions, their settings and related items will not appear on the menu.



1. Select  (**Menu**) from the hot key menu.
2. Use  or  to select **Controller Key**.
3. Select  to go to a sub menu, and then use  or  to select a menu item.
4. Use  or  to make adjustments, or use **OK** to make selection.
5. To return to the previous menu, select .
6. To exit the menu, select .















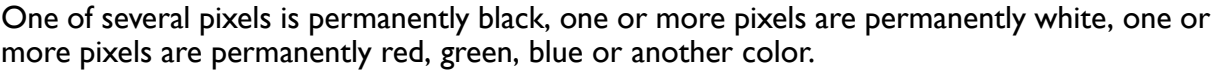

Item	Function	Range
Controller Key 1, 2, 3	Sets the function to be accessed by controller key 1 / 2 / 3 on Hotkey Puck G2. See Hotkey Puck G2 and its basic operations on page 42 for the location of the keys. Select a category first, and choose up to 3 options to be accessed by these keys. The numbers displayed next to the selected items are the controller keys that the options are designated to.	<ul style="list-style-type: none"> • Color Mode • Input
Rotation Key	Sets the function to be accessed by the Rotation key on Hotkey Puck G2. See Hotkey Puck G2 and its basic operations on page 42 for the location of the key. Select a category first, and choose up to 3 options to be accessed by this key.	<ul style="list-style-type: none"> • Color Mode • Input • Mute

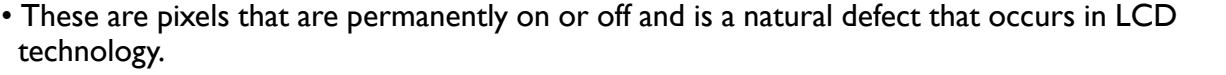

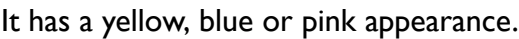

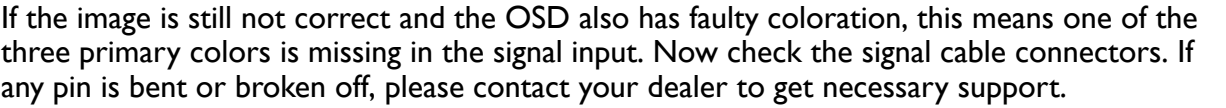
Item	Function	Range
Controller Key Dial	Sets the function to be accessed by the Dial key on Hotkey Puck G2. See Hotkey Puck G2 and its basic operations on page 42 for the location of the key.	<ul style="list-style-type: none"> • Brightness • Contrast • Volume

Troubleshooting



Frequently asked questions (FAQ)

Imaging



-  The image is blurred.
-  • Download **Resolution file** from the website (see [Product support on page 3](#)). Refer to "**Adjusting the Screen Resolution**". And then select the correct resolution, refresh rate and make adjustments based on these instructions.
-  • If a VGA extension cable is used, remove the extension cable for the test. Is the image now in focus? Download **Resolution file** from the website (see [Product support on page 3](#)). Refer to "**Adjusting the Screen Resolution**". And then select the correct resolution, refresh rate and make adjustments based on these instructions to optimize the image. It is normal for blurring to occur due to conduction losses in extension cables. You can minimize these losses by using an extension cable with better conduction quality or with a built-in booster.
-  Does the blurring only occur at resolutions lower than the native (maximum) resolution?
-  Download **Resolution file** from the website (see [Product support on page 3](#)). Refer to "**Adjusting the Screen Resolution**". Select the native resolution.
-  Pixel errors can be seen.
-  One of several pixels is permanently black, one or more pixels are permanently white, one or more pixels are permanently red, green, blue or another color.
-  • Clean the LCD screen.
-  • Cycle power on-off.
-  • These are pixels that are permanently on or off and is a natural defect that occurs in LCD technology.
-  The image has a faulty coloration.
-  It has a yellow, blue or pink appearance.
-  Go to **Picture** and **Reset Color**, and then choose **YES** to reset the color settings to the factory defaults.
-  If the image is still not correct and the OSD also has faulty coloration, this means one of the three primary colors is missing in the signal input. Now check the signal cable connectors. If any pin is bent or broken off, please contact your dealer to get necessary support.
-  The image is distorted, flashes or flickers.
-  Download **Resolution file** from the website (see [Product support on page 3](#)). Refer to "**Adjusting the Screen Resolution**". And then select the correct resolution, refresh rate and make adjustments based on these instructions.
-  You are running the monitor at its native resolution, but the image is still distorted.
-  Images from different input sources may appear distorted or stretched on the monitor running at its native resolution. To have the optimal display performance of each type of input sources, you can use the **Display Mode** function to set a proper aspect ratio for the input sources. See [Aspect Ratio on page 51](#) for details.

-  The image is displaced in one direction.
-  Download **Resolution file** from the website (see [Product support on page 3](#)). Refer to "**Adjusting the Screen Resolution**". And then select the correct resolution, refresh rate and make adjustments based on these instructions.
-  Faint shadow from the static image displayed is visible on the screen.
- 
 - Activate the power management function to let your computer and monitor go into a low power "sleep" mode when not actively in use.
 - Use a screensaver to prevent the occurrence of image retention.



Power LED indicator

-  The LED indicator is solid white or flashing white.
- 
 - If the LED lights up in solid white, the monitor is powered on.
 - If the LED is illuminated in white and there is a message **Out of Range** on the screen, this means you are using a display mode that this monitor does not support, please change the setting to one of the supported mode. Download **Resolution file** from the website (see [Product support on page 3](#)). Refer to "**Adjusting the Screen Resolution**". And then select the correct resolution, refresh rate and make adjustments based on these instructions.
 - If the LED is illuminated in flashing white, the power management mode is active. Press any button on the computer keyboard or move the mouse. If that does not help, check the signal cable connectors. If any pin is bent or broken off, please contact your dealer to get necessary support.
 - If the LED is off, check the power supply mains socket, the external power supply and the mains switch.

OSD controls

-  The OSD controls are inaccessible.
-  To unlock the OSD controls when it is preset to be locked, press and hold any key for 10 seconds.

OSD messages

-  A message **Out of Range** on the screen during computer boot up process.
-  If there is a message **Out of Range** on the screen during computer boot up process, this means computer compatibility caused by operating system or graphic card. The system will adjust the refresh rate automatically. Just wait until the operating system is launched.

Audio

- ❓ No sound can be heard from the connected external speakers.
- ✅
 - Remove your headphone (if the headphone is connected to the monitor).
 - Check whether the headphone jack is properly connected.
 - If the external speakers are USB-powered, check whether the USB connection is OK.
 - Increase the volume (volume may be muted or too low) on the external speakers.
 - If USB-C™ connection is established, make sure the appropriate audio output setting on your laptop has been selected. You may look for options similar to "USB headphone".

HDR

- ❓ There is a message **HDR: Emulated** showing on the screen.
- ✅ This means the input content is not HDR-compatible and the monitor is in HDR-emulated mode. Refer to [Working with HDR technology on page 45](#) to check if a supported player, content, and the certified cable are used.

USB-C™ connection

- ❓ No video or audio output from the laptop with USB-C™ connection.
- ✅ Check the cable connections and menu settings in the following order:
 - Check if the USB-C™ cable has been connected to the monitor and the laptop properly. See [Connect the PC video cable on page 20](#) for more information.
 - Check if the input source has been selected to **USB-C** on **Display > Input**.

Need more help?

If your problems remain after checking this manual, please contact your place of purchase or visit the local website from www.BenQ.com for more support and local customer service.

Appendix: Advanced software

Apart from the built-in technologies and features available on this product, you are provided with more software applications to enhance and extend the product functionality. Download the software and its user guide as instructed from the BenQ website.

- **Palette Master Element**

The **Palette Master Element** software simplifies calibration and reliably produces accurate color results. Palette Master Element can be used to fine-tune the color engine in certain BenQ monitors and fully supports X-Rite / Datacolor colorimeters.

- **Paper Color Sync**

The **Paper Color Sync** software helps sync the color settings between the image, the computer, and the printer so the printing result is predictable.

Software access: www.BenQ.com > **Support** > **Download & FAQ** > the purchased model > the **Software** tab

User guide: www.BenQ.com > **Support** > **Download & FAQ** > the purchased model > the **User Manual** tab