



# LCD Monitor Quick Start Guide

DesignVue Designer Monitor | PD Series



DN: PD00U-Q-V1

© 2019 BenQ Corporation. All rights reserved. Rights of modification reserved.

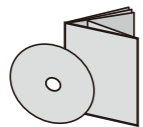
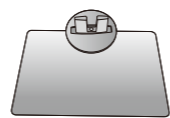
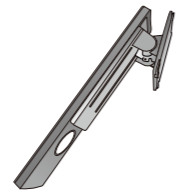
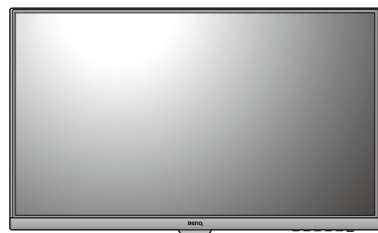
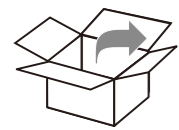
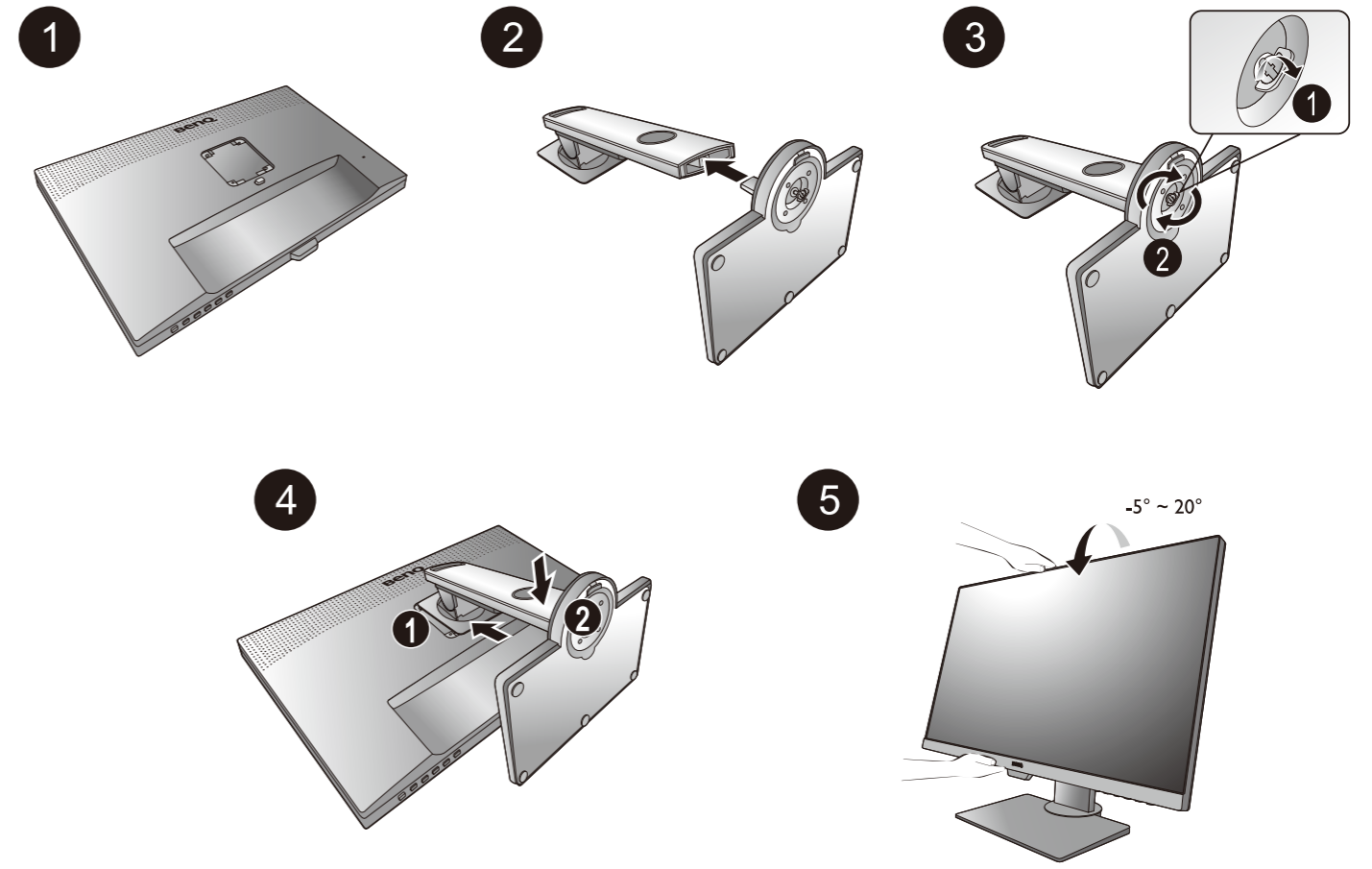

DP to mini-DP



HDMI

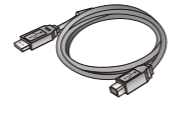

USB



DP (optional)



- 6 Video
- 7 Audio
- 8 USB

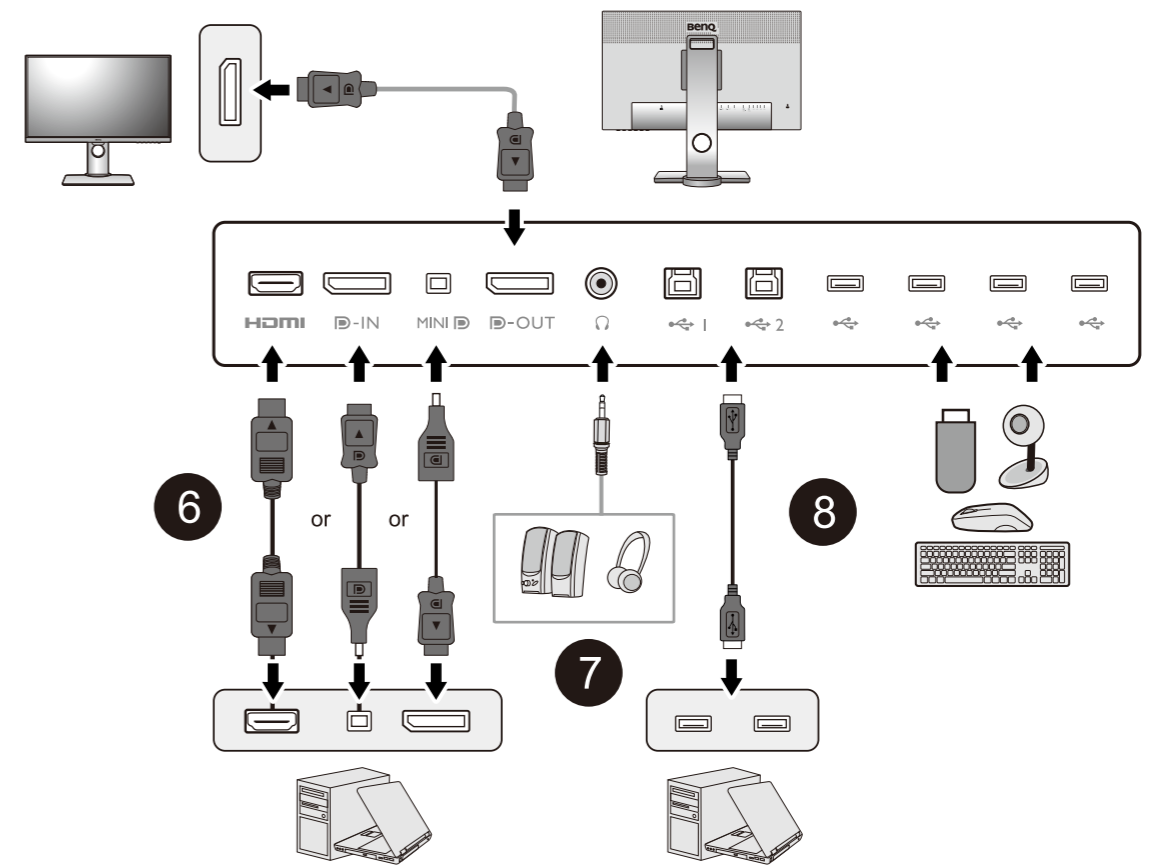

9

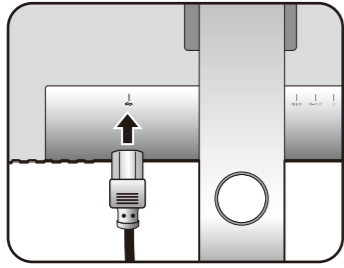

10

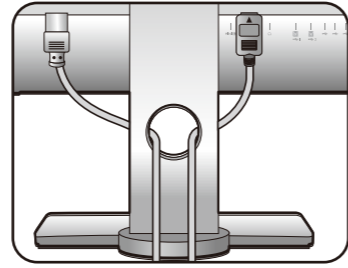

11

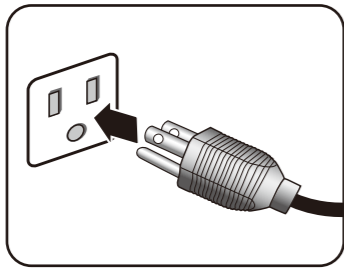

12

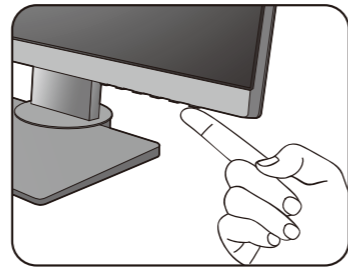

### Connecting multiple monitors via MST (Multi-Stream Transport)

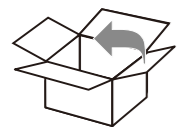
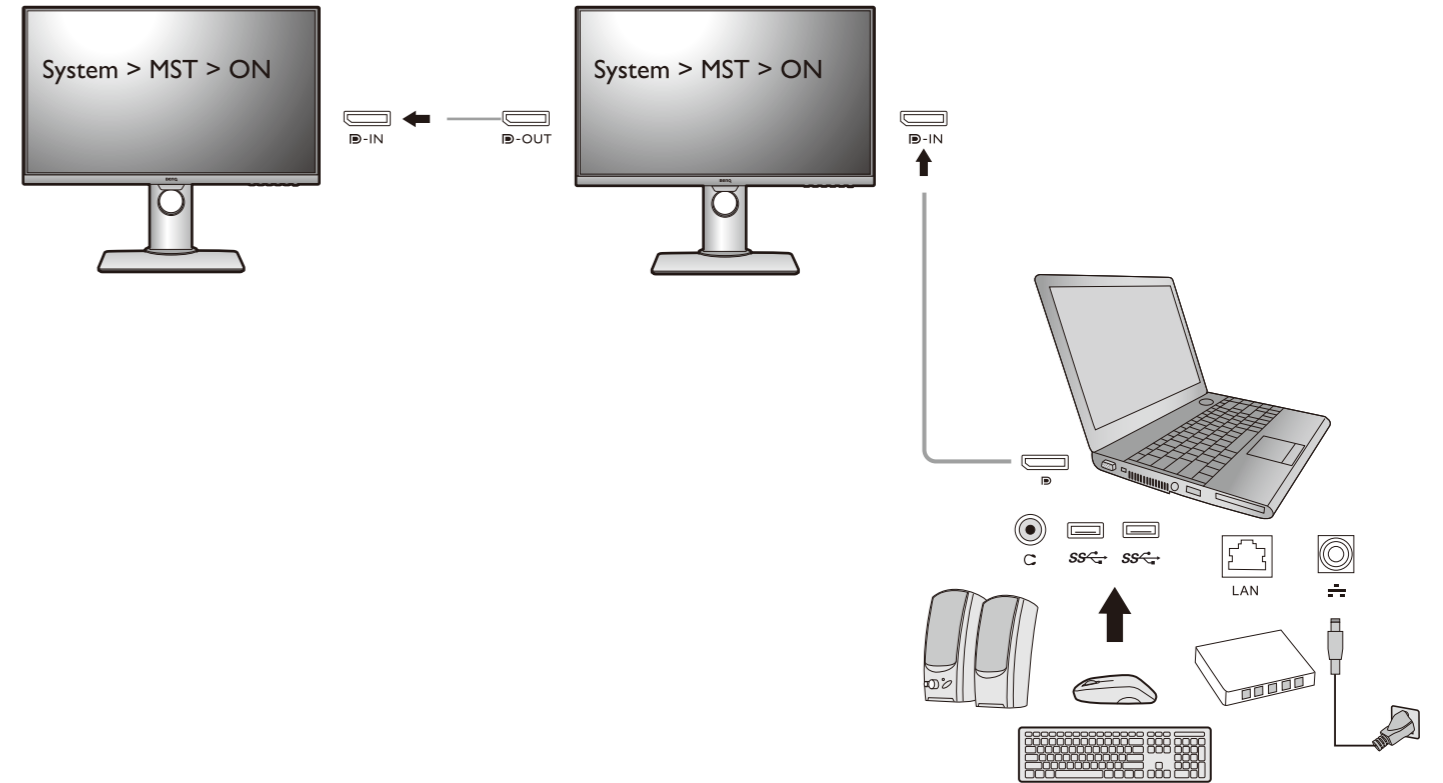

1

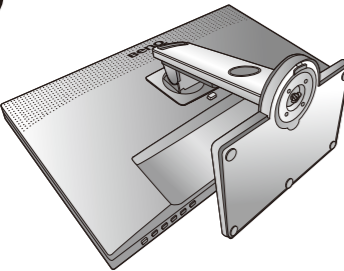

2

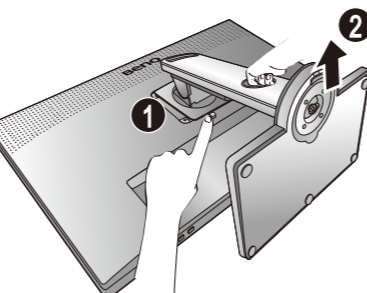

3

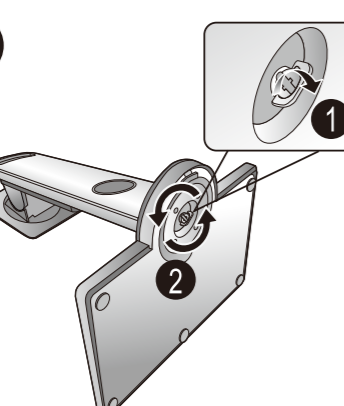

4

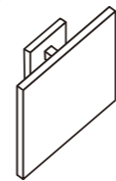
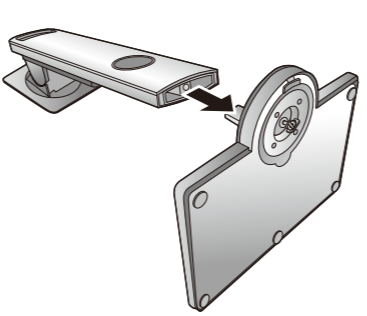

1

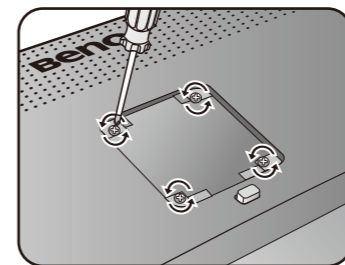

2

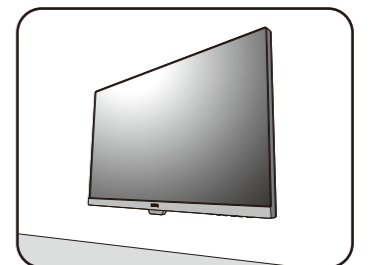

M4 x 10 mm



PD2700U



CAD / CAM mode



Animation Mode



DualView



KVM Switch

