



LCD Monitor

User Manual

Gaming Monitor | EX Series

Copyright

Copyright © 2020 by BenQ Corporation. All rights reserved. No part of this publication may be reproduced, transmitted, transcribed, stored in a retrieval system or translated into any language or computer language, in any form or by any means, electronic, mechanical, magnetic, optical, chemical, manual or otherwise, without the prior written permission of BenQ Corporation.

Disclaimer

BenQ Corporation makes no representations or warranties, either expressed or implied, with respect to the contents hereof and specifically disclaims any warranties, merchantability or fitness for any particular purpose. Further, BenQ Corporation reserves the right to revise this publication and to make changes from time to time in the contents hereof without obligation of BenQ Corporation to notify any person of such revision or changes.

The performance of flicker-free may be affected by external factors such as poor cable quality, unstable power supply, signal interference, or poor grounding, and not limited to the above mentioned external factors. (Applicable for flicker-free models only.)

BenQ ecoFACTS

BenQ has been dedicated to the design and development of greener product as part of its aspiration to realize the ideal of the "Bringing Enjoyment 'N Quality to Life" corporate vision with the ultimate goal to achieve a low-carbon society. Besides meeting international regulatory requirement and standards pertaining to environmental management, BenQ has spared no efforts in pushing our initiatives further to incorporate life cycle design in the aspects of material selection, manufacturing, packaging, transportation, using and disposal of the products. BenQ ecoFACTS label lists key eco-friendly design highlights of each product, hoping to ensure that consumers make informed green choices at purchase. Check out BenQ's CSR Website at <http://csr.BenQ.com/> for more details on BenQ's environmental commitments and achievements.



Product support

This document aims to provide the most updated and accurate information to customers, and thus all contents may be modified from time to time without prior notice. Please visit the website for the latest version of this document and other product information. Available files vary by model.

1. Make sure your computer is connected to the Internet.
2. Visit the local website from Support.BenQ.com. The website layout and content may vary by region/country.
 - User manual and related document
 - Drivers and applications
 - (EU only) Dismantled information: Available on the user manual download page. This document is provided based on Regulation (EU) 2019/2021 to repair or recycle your product. Always contact the local customer service for servicing within the warranty period. If you wish to repair an out-of-warranty product, you are recommended to go to a qualified service personnel and obtain repair parts from BenQ to ensure compatibility. Do not disassemble the product unless you are aware of the consequences. If you cannot find the dismantled information on your product, contact the local customer service for assistance.

Power safety



Please follow these safety instructions for best performance, and long life for your monitor.

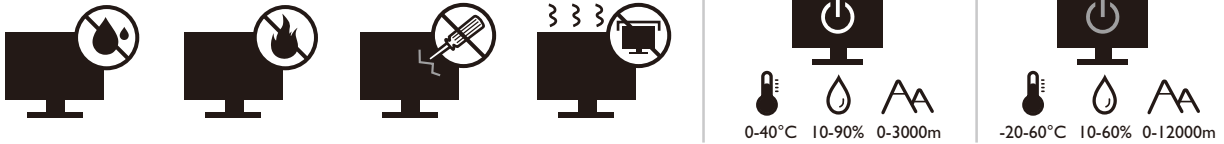

- The AC plug isolates this equipment from the AC supply.
- The power supply cord serves as a power disconnect device for pluggable equipment. The socket outlet should be installed near the equipment and be easily accessible.
- This product should be operated from the type of power indicated on the marked label. If you are not sure of the type of power available, consult your dealer or local power company.
- The Class I pluggable equipment Type A must be connected to protective earth.
- An approved power cord greater or equal to H03VV-F or H05VV-F, 2G or 3G, 0.75mm² must be used.
- Use only the power cord provided by BenQ. Never use a power cord that appears to be damaged or frayed.

For Germany only:

- (If the weight of the product is less than or equal to 3 kg) An approved power cord greater or equal to H03VV-F, 3G, 0.75mm² must be used.
- (If the weight of the product is more than 3 kg) An approved power cord greater or equal to H05VV-F or H05RR-F, 3G, 0.75mm² must be used.
- (If a remote control is provided) RISK OF EXPLOSION IF BATTERY IS REPLACED BY AN INCORRECT TYPE. DISPOSE OF USED BATTERIES ACCORDING TO THE INSTRUCTIONS.

For models with adapter:

- Use only the power adapter supplied with your LCD Monitor. Use of another type of power adapter will result in malfunction and/or danger.
- Allow adequate ventilation around the adapter when using it to operate the device or charge the battery. Do not cover the power adapter with paper or other objects that will reduce cooling. Do not use the power adapter while it is inside a carrying case.
- Connect the power adapter to a proper power source.
- Do not attempt to service the power adapter. There are no service parts inside. Replace the unit if it is damaged or exposed to excess moisture.

Care and cleaning

- Do not place the monitor face down on the floor or a desk surface directly. Otherwise, scratches on the panel surface may occur.
- The equipment is to be secured to the building structure before operation.
- (For models that support wall or ceiling mounting)
 - Install your monitor and monitor mounting kit on a wall with flat surface.
 - Ensure that the wall material and the standard wall mount bracket (purchased separately) are stable enough to support the weight of the monitor.
 - Turn off the monitor and the power before disconnecting the cables from the LCD monitor.
- Always unplug the product from the power outlet before cleaning. Clean the LCD monitor surface with a lint-free, non-abrasive cloth. Avoid using any liquid, aerosol or glass cleaners.
- Slots and openings on the back or top of the cabinet are for ventilation. They must not be blocked or covered. Your monitor should never be placed near or over a radiator or heat sources, or in a built-in installation unless proper ventilation is provided.
- Do not place heavy loads on the monitor to avoid possible personal injury or damage to the monitor.
- Consider keeping the box and packaging in storage for use in the future when you may need to transport the monitor.
- Refer to the product label for information on power rating, manufacture date, and identification markings.

Servicing



- Do not attempt to service this product yourself, as opening or removing covers may expose you to dangerous voltages or other risks. If any of the above mentioned misuse or other accident such as dropping or mishandling occurs, contact qualified service personnel for servicing.
- Contact your place of purchase or visit the local website from Support.BenQ.com for more support.



Caution

- The monitor should be 50 ~ 70 cm (20 ~ 28 inches) away from your eyes.
- Looking at the screen for an extended period of time causes eye fatigue and may deteriorate your eyesight. Rest your eyes for 5 ~ 10 minutes for every 1 hour of product use.
- Reduce your eye strain by focusing on objects far way.
- Frequent blinking and eye exercise help keep your eyes from drying out.

Typographics

Icon / Symbol	Item	Meaning
	Warning	Information mainly to prevent the damage to components, data, or personal injury caused by misuse and improper operation or behavior.
	Tip	Useful information for completing a task.
	Note	Supplementary information.

In this document, the steps needed to reach a menu may be shown in condensed form, for example: **Menu > System > Information.**

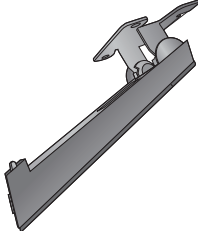
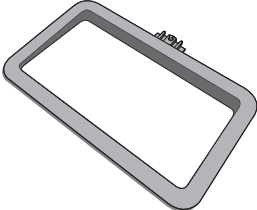

Table of Contents





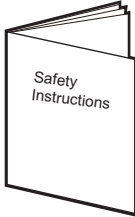
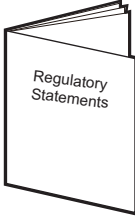

Copyright	2
Product support	3
Getting started	9
Getting to know your monitor	12
Front view	12
Back view.....	12
Connections	13
Getting to know your remote control	14
Front view	14
Installing the battery	15
How to assemble your monitor hardware	17
How to detach the stand and the base	22
Using the monitor wall mounting kit (Models with VESA standard mounting holes)	23
Getting the most from your BenQ monitor	24
Downloading the LCD Monitor driver files from the Internet.....	24
How to install the monitor on a new computer	25
How to upgrade the monitor on an existing computer	26
How to install on Windows 10 system	27
How to install on Windows 8 (8.1) system	28
How to install on Windows 7 system	29
How to adjust your monitor	30
The remote control.....	30
The control panel.....	31
5-way controller and basic menu operations	32
Working with the hot keys.....	34
Working with the HDR Mode key	35
Adjusting screen brightness automatically (Bright Intelligence Plus).....	36
Working with HDR technology.....	36
Adjusting volume quickly	37
Choosing an audio scenario.....	37
Adjusting display mode.....	38
Choosing an appropriate picture mode.....	38
Connecting the monitor to your MacBook series product	38
Enabling color vision accessibility (Color Weakness).....	38
Activating FreeSync™ Premium	39
Working with Video Format Support technology.....	39
Navigating the main menu	40
Input menu	41
Picture menu	42

Color menu	44
Audio menu	47
Eye Care menu	49
Custom Key menu	51
System menu	52
Troubleshooting	55
Frequently asked questions (FAQ)	55
Need more help?.....	58

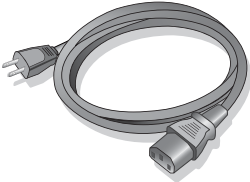
Getting started

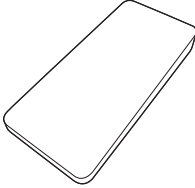
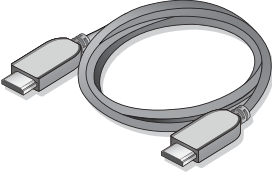
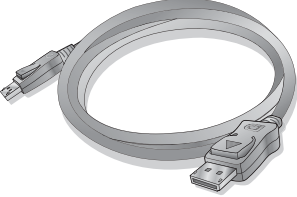
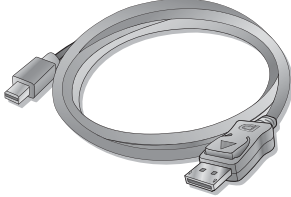
When unpacking please check you have the following items. If any are missing or damaged, please contact the place of purchase for a replacement.

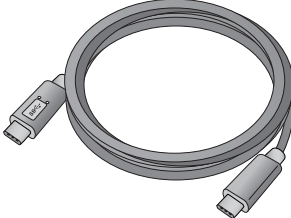
BenQ LCD Monitor	
Monitor Stand	
Monitor Base	
Quick Start Guide	
Safety Instructions	
Regulatory Statements	

<p>Power Cord (Picture may differ from product supplied for your region.)</p>	
<p>Remote Control (RC-0011, with one CR2032 battery)</p>	
<p>Remote Control Holder</p>	
<p>Video Cable: HDMI</p>	
<p>Video Cable: DP (Optional accessory)</p>	
<p>Video Cable: DP to mini DP (Optional accessory)</p>	
<p>Video Cable: USB-C™</p> <p> The length of USB-C™ cable should be less than 1 meter to make the connection easy.</p>	
<p>Audio Cable (Optional accessory)</p>	



- Available accessories and the pictures shown here may differ from the actual contents and the product supplied for your region. And the package contents may subject to change without prior notice. For cables that are not supplied with your product, you can purchase them separately.
- Consider keeping the box and packaging in storage for use in the future when you may need to transport the monitor. The fitted foam packing is ideal for protecting the monitor during transport.



Always keep the product and accessories out of reach of small children.

Getting to know your monitor

Front view

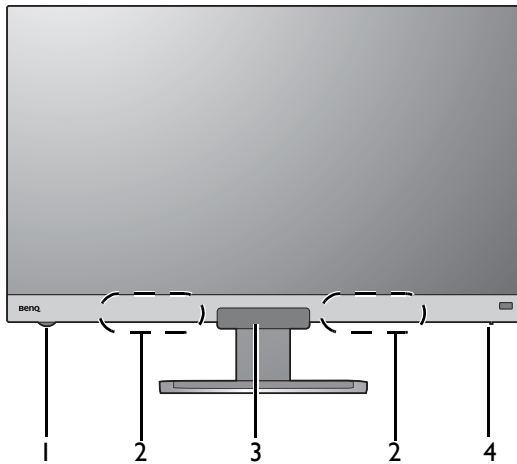

1. Volume knob
2. Speakers
3. Light sensor / proximity sensor / IR receiver (for remote control)
4. Power indicator

Back view

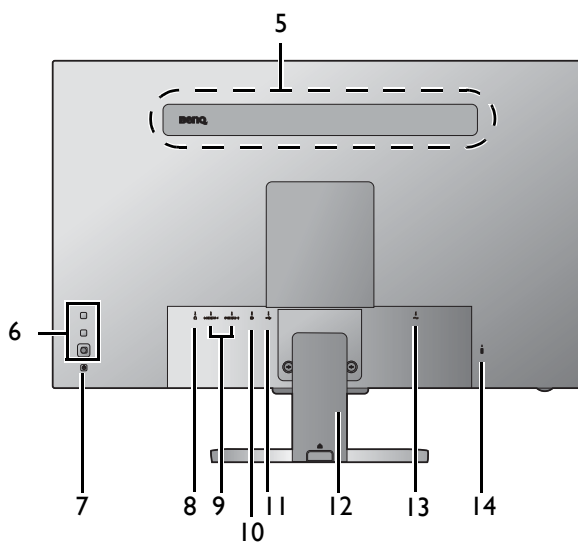

5. Speakers
6. Control buttons
7. Power button
8. Headphone jack
9. HDMI socket x 2
10. DisplayPort socket
11. USB-C™ port (for data transfer only)
12. Cable cover
13. AC power input jack
14. Kensington lock slot



- Above diagram may vary depending on the model.
- Picture may differ from product supplied for your region.

Connections

The following connection illustrations are for your reference only. For cables that are not supplied with your product, you can purchase them separately.

For detailed connection methods, see page 20.

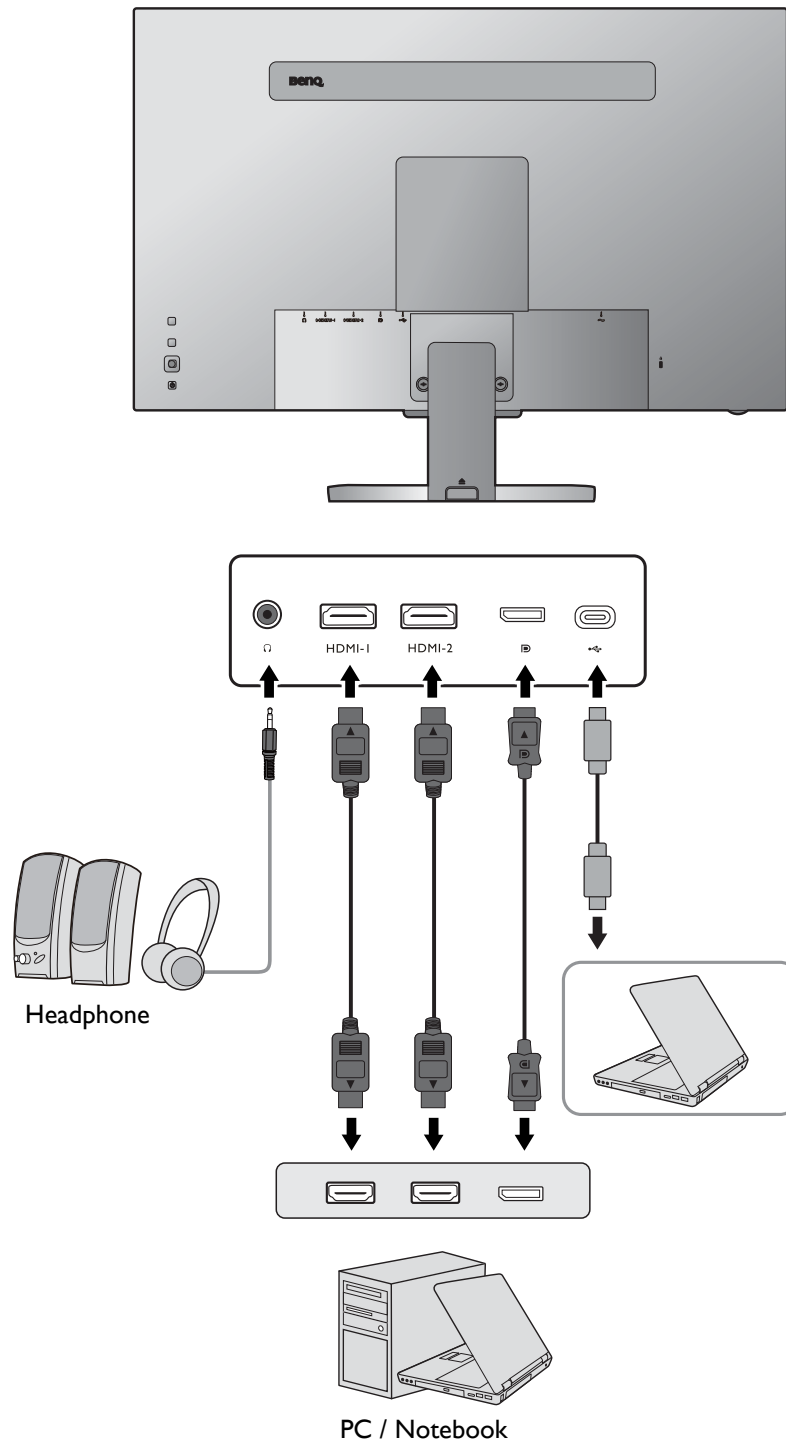



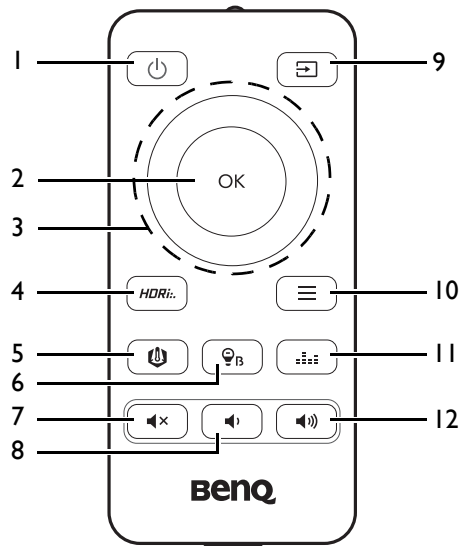

Getting to know your remote control

Front view



No.	Name	Key	Description
1	Power key		Turns the power on or off.
2	OK key		<ul style="list-style-type: none"> Enters sub menu. Confirms the selection.
3	Navigation keys		<ul style="list-style-type: none"> Goes to the previous menu item. For up / increase adjustment
			Enters sub menus.
			<ul style="list-style-type: none"> Goes to the next menu item. For down / decrease adjustment.
			<ul style="list-style-type: none"> Returns to the previous menu. Exits OSD menu.
4	HDR Mode key		Accesses a list of HDR options. Press repeatedly to cycle through these options. See Working with the HDR Mode key on page 35 for more information.
5	B.I.+ key		Enables / disables B.I.+ function. See Adjusting screen brightness automatically (Bright Intelligence Plus) on page 36 for more information.
6	Low Blue Light key		Accesses a list of Low Blue Light options. Press repeatedly to cycle through these options. See Low Blue Light on page 50 for more information.
7	Mute key		Mutes / unmutes the volume.
8	Volume down key		Decreases the volume.

No.	Name	Key	Description
9	Input source key		Accesses a list of available input sources. Press repeatedly to cycle through these options.
10	Menu key		<ul style="list-style-type: none"> • Activates OSD main menu. • (When the hotkey menu has been activated) Closes the hotkey menu.
11	Audio Scenario key		Accesses a list of audio scenario options. Press repeatedly to cycle through these options.
12	Volume up key		Increases the volume.



OSD = On Screen Display.

Installing the battery

1. Turn over the remote control. Remove the battery cover as illustrated.

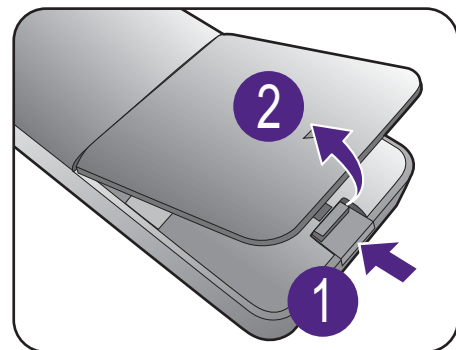

2. Press down the upper part of the battery so you can remove the battery from the lower part as illustrated.

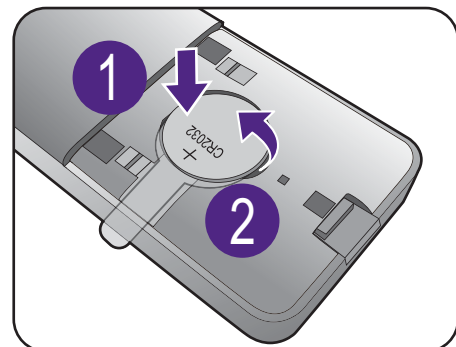

3. Remove the battery insulation sheet.

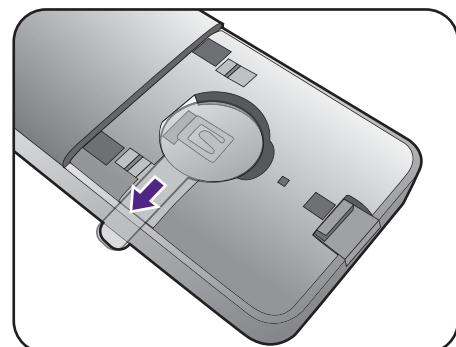

4. Replace the provided battery (CR2032) onto the battery holder properly. Make sure that the positive terminal (+) faces upward.

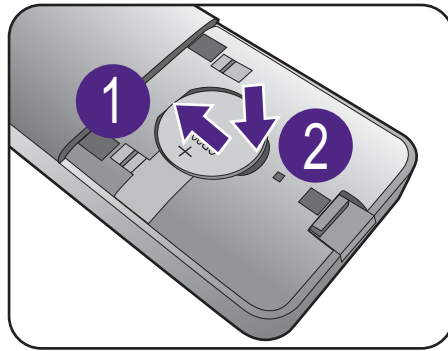

5. Replace the battery cover.
The remote control is ready to use now.

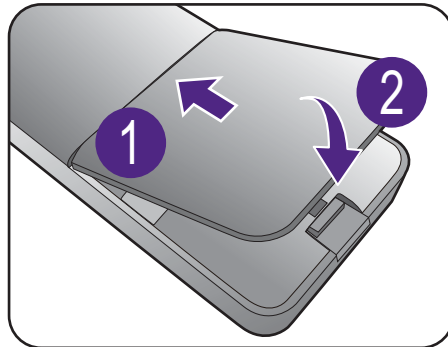

- Keep the remote control and the battery out of reach of children.
- The remote control supplied with this product contains a coin / button cell battery. If the coin / button cell battery is swallowed, it can cause severe internal burns in just 2 hours and can lead to death.
- If the remote control will not be used for an extended period of time, remove the battery.

How to assemble your monitor hardware



- If the computer is turned on you must turn it off before continuing.
Do not plug-in or turn-on the power to the monitor until instructed to do so.
- The following illustrations are for your reference only. Available input and output jacks may vary depending on the purchased model.
- Avoid finger pressure on the screen surface.

I. Attach the monitor base.



Please be careful to prevent damage to the monitor. Placing the screen surface on an object like a stapler or a mouse will crack the glass or damage the LCD substrate voiding your warranty. Sliding or scraping the monitor around on your desk will scratch or damage the monitor surround and controls.

Protect the monitor and screen by clearing a flat open area on your desk and placing a soft item like the monitor packaging bag on the desk for padding.

Gently lay the screen face down on a flat clean padded surface.

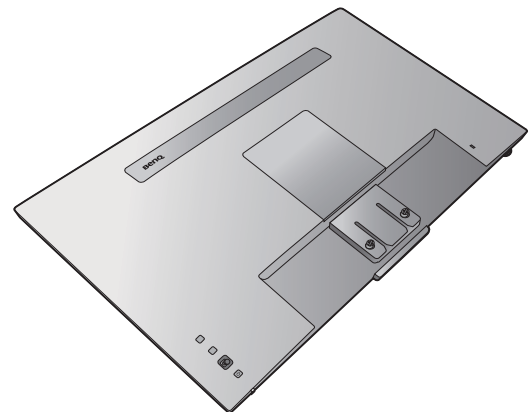

Attach the monitor stand to the monitor base as illustrated until it locks in place.

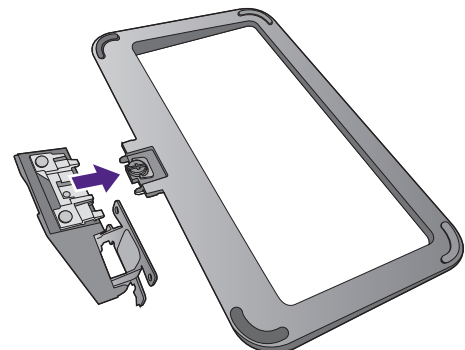

Raise the thumbscrew lid and tighten the thumbscrew as illustrated. Then push the lid back.

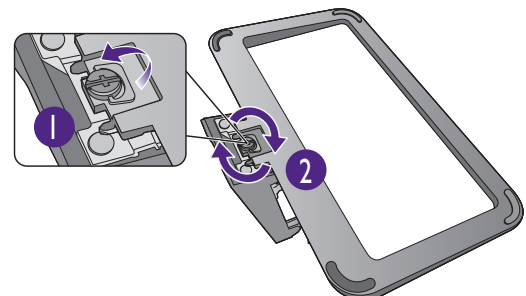

Orient and align the stand arm with the monitor, then push them together until they click and lock into place.

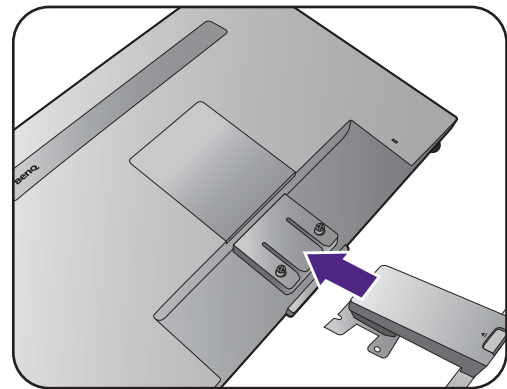

Tighten the screws that fix the stand to the monitor.



To secure or release a screw, a flat-head screwdriver or a coin is required.



Depending on the monitor size, there may be more than one screw that fixes the stand to the monitor. The illustrations in this document are for your reference only and may look different from the appearance of the product.

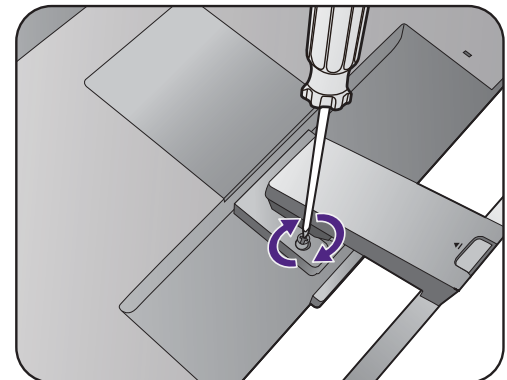

Carefully lift the monitor, turn it over and place it upright on its stand on a flat even surface.

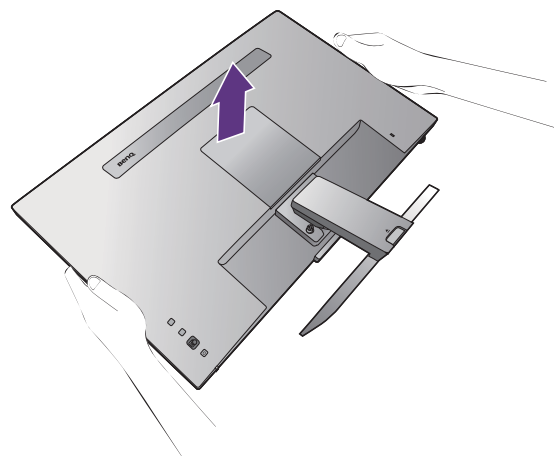

You should position the monitor and angle the screen to minimize unwanted reflections from other light sources.



Your monitor is an edge-to-edge monitor and should be handled with care. Avoid finger pressure on the screen surface. Excessive force on the display is prohibited.

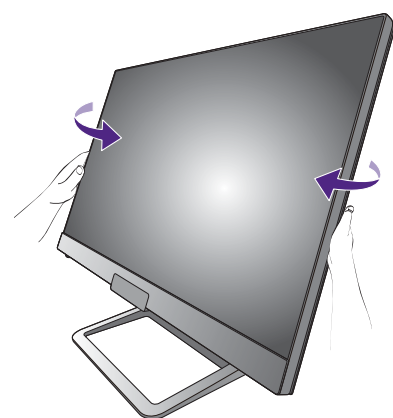

2. Remove the cover of the cable management system.

The stand arm also works as a cable management system that helps keep the cables neat and clean. Slide the cable cover up to align the marking on the cable cover with the unlock icon on the stand arm. Remove the cover as illustrated. You can have one power cord, two video cables, and one audio cable routed together.

Pass a cable through the cable management hole on the stand arm first while cabling. Start with the ones with bigger connectors.

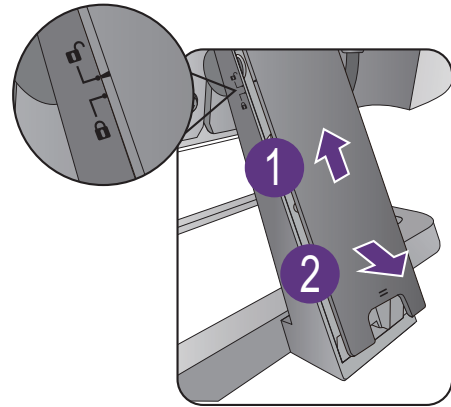

Allow enough cable length while cabling to avoid loose connection and to save the pins or socket connectors from being bent or broken.

3. Connect the power cable to the monitor.

Pass the cable through the cable management hole on the stand arm first.

Plug one end of the power cord into the socket labelled  on the rear of the monitor. Do not connect the other end to a power outlet just yet.

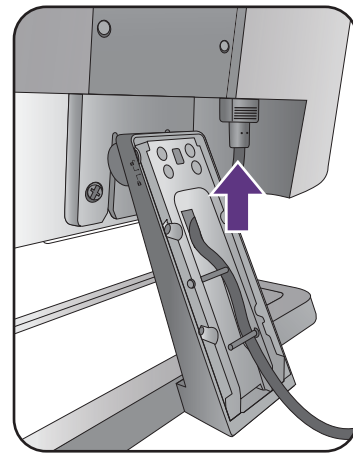

4. Connect the PC video cable.



The video cables included in your package and the socket illustrations in this document may vary depending on the product supplied for your region.

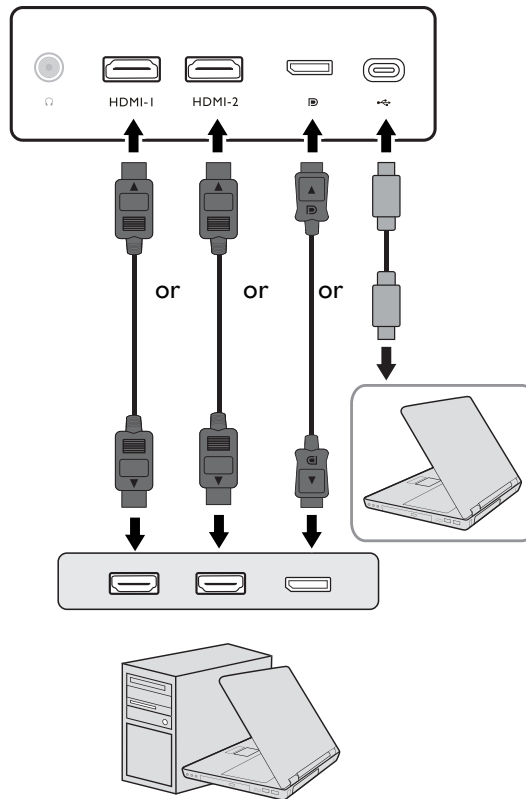

- Connect the plug of the HDMI cable to the HDMI port on the monitor. Connect the other end of the cable to the HDMI port of a digital output device.
- Connect the plug of the DP cable to the monitor video socket. Connect the other end of the cable to the computer video socket.
- Connect the plug of the supplied USB-C™ cable to the USB-C™ port on the monitor. Connect the other end of the cable to the USB-C™ port of a laptop. It allows signal, audio, and data transmission from the laptop to the monitor.



The USB-C™ port on the monitor transfers data only and does not support power delivery to the laptop. Additional power supply to the connected laptop is required.

5. Connect the audio cable.

You may connect headphones to the headphone jack found on the back side of the monitor.

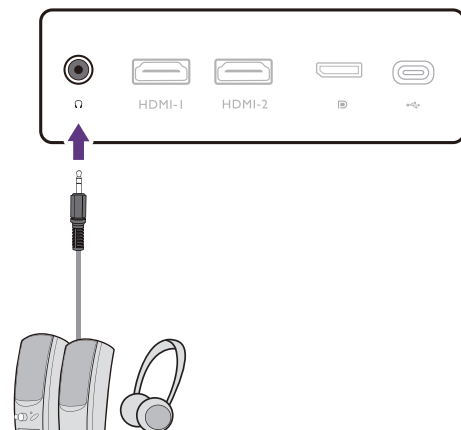

6. Install the cable cover.

After all cables have been connected to the monitor, work with the cable management system to route the cables properly.

Align the marking on the cable cover to the unlock icon on the stand arm. Install the cable cover back to the stand arm, and slide down to lock it into place. The marking on the cable cover should be aligned with the lock icon on the stand arm by now.

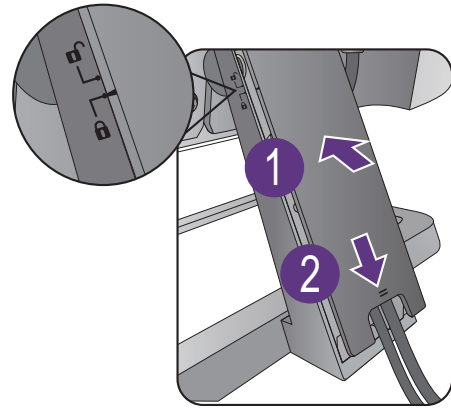

7. Connect-to and turn-on the power.

Plug the other end of the power cord into a power outlet and turn it on.



Picture may differ from product supplied for your region.

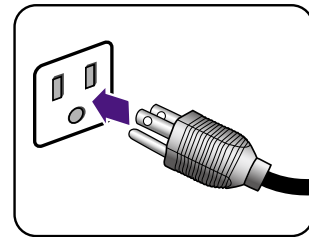

Turn on the monitor by pressing the power button on the monitor.

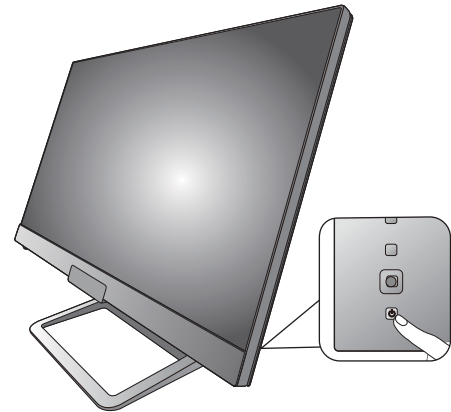

Turn on the computer too, and press the 5-way controller to select an input source. The displayed input icons vary depending on the available video inputs of the purchased model.

Follow the instructions in [Getting the most from your BenQ monitor on page 24](#) to install the monitor software.

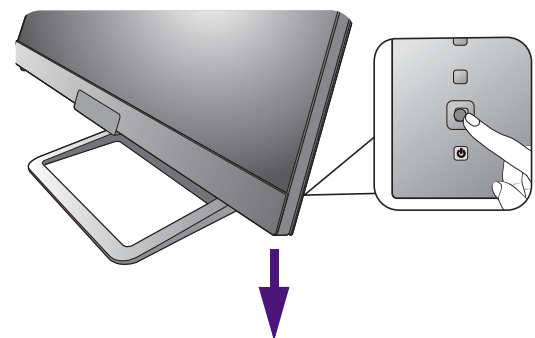

To extend the service life of the product, we recommend that you use your computer's power management function.

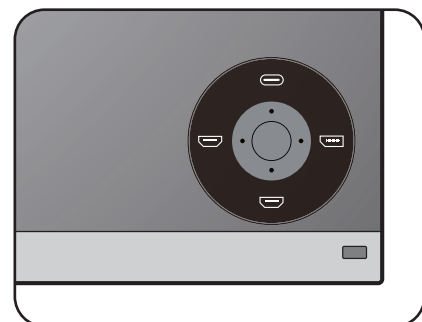



How to detach the stand and the base

1. Prepare the monitor and area.

Turn off the monitor and the power before unplugging the power cable. Turn off the computer before unplugging the monitor signal cable.

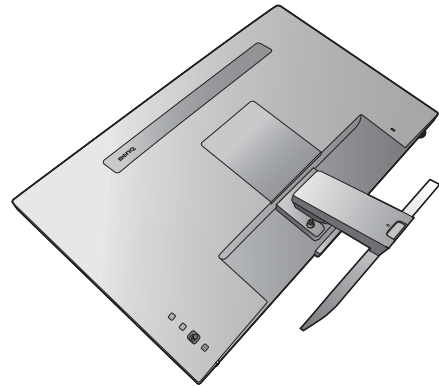
Protect the monitor and screen by clearing a flat open area on your desk and placing a soft item like a towel on the desk for padding, before laying the screen face down on a flat clean padded surface.



-  Please be careful to prevent damage to the monitor. Placing the screen surface on an object like a stapler or a mouse will crack the glass or damage the LCD substrate voiding your warranty. Sliding or scraping the monitor around on your desk will scratch or damage the monitor surround and controls.

2. Remove the monitor stand.

Release the screws that fix the stand to the monitor. Then pull the monitor stand backward away from the monitor.

-  To secure or release a screw, a flat-head screwdriver or a coin is required.

-  Depending on the monitor size, there may be more than one screw that fixes the stand to the monitor. The illustrations in this document are for your reference only and may look different from the appearance of the product.

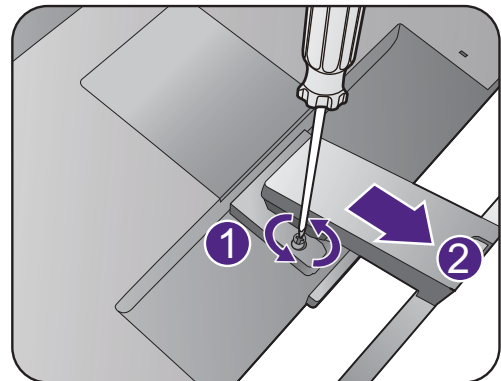

3. Remove the monitor base.

Release the screw on the bottom of the monitor base and detach the monitor base as illustrated.

-  In case you intend to use your monitor on the stand in the future, please keep the monitor base, monitor stand, and screws somewhere safe for future use.

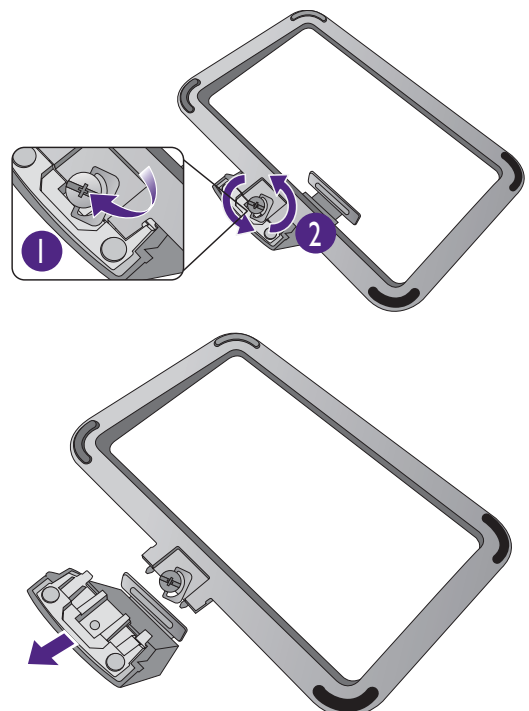

Using the monitor wall mounting kit (Models with VESA standard mounting holes)

The back of your LCD monitor has a VESA standard mount with 100mm pattern, allowing the installation of a wall mount bracket. Before starting to install a monitor wall mounting kit, please read the precautions carefully.

Precautions

- Install your monitor and monitor mounting kit on a wall with flat surface.
- Ensure that the wall material and the standard wall mount bracket (purchased separately) are stable enough to support the weight of the monitor. Refer to the product specifications on the website for weight information.
- Turn off the monitor and the power before disconnecting the cables from the LCD monitor.

1. Remove the monitor stand.

Lay the screen face down on a clean and well-padded surface. Detach the monitor stand as instructed in step 1~2 in [How to detach the stand and the base on page 22](#).

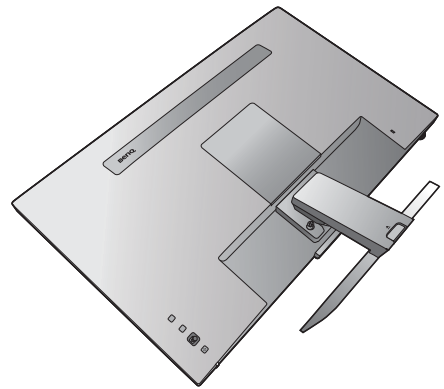

2. Remove the back cover.

Use the finger nail or a flat head screwdriver to lift the back cover up and away from the monitor as illustrated.

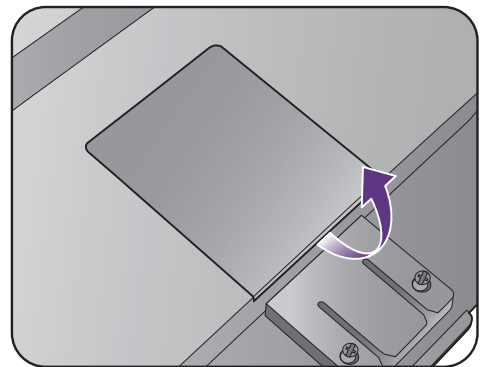

3. Follow the instruction manuals of the wall mount bracket you purchased to complete the installation.



Use four M4 x 10 mm screws to fix a VESA standard wall mount bracket to the monitor. Make sure that all screws are tightened and secured properly. Consult a professional technician or BenQ service for wall mount installation and safety precautions.

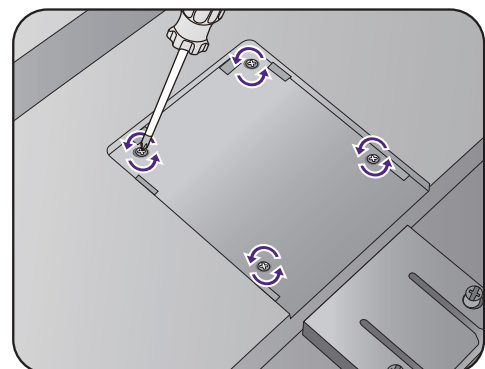

Getting the most from your BenQ monitor

To gain the most benefit from your new BenQ LCD monitor, you should install the custom BenQ LCD Monitor driver software as provided on the local website. See [Downloading the LCD Monitor driver files from the Internet on page 24](#) for details.

The circumstances under which you connect and install your BenQ LCD Monitor will determine which process you need to follow to successfully install the BenQ LCD Monitor driver software. These circumstances relate to which version of Microsoft Windows you are using, and whether you are connecting the monitor and installing the software onto a new computer (without existing monitor driver software), or whether you are upgrading an existing installation (which already has existing monitor driver software) with a newer monitor.

In either case however, the very next time you turn on your computer (after connecting the monitor to your computer), Windows will automatically recognize the new (or different) hardware, and will launch its **Found New Hardware wizard**.

Follow the wizard instructions. Further details and step-by-step instructions for either an automatic (new) or upgrade (existing) installation, see:

- [How to install the monitor on a new computer on page 25](#).
- [How to upgrade the monitor on an existing computer on page 26](#).



- If you require a User Name and Password to login to your Windows computer, you must be logged on as an Administrator or as a member of the Administrators group in order to install the monitor driver software. Furthermore, if your computer is connected to a network which has security access requirements, network policy settings may prevent you from installing software on your computer.
 - To check the name of the purchased model, refer to the specification label on the back of the monitor.
-

Downloading the LCD Monitor driver files from the Internet

1. Download the correct driver files from Support.BenQ.com.
2. On your computer, have your driver files extracted into an empty folder. Remember the file location the files are extracted to.

How to install the monitor on a new computer

This instruction details the procedure for selecting and installing the BenQ LCD Monitor driver software on a new computer which has never had a monitor driver installed before. This instruction is only suitable for a computer which has never been used before, and for which the BenQ LCD Monitor is the first ever monitor to be connected to it.



If you are adding the BenQ LCD Monitor to an existing computer that has already had another monitor connected to it (and has monitor driver software installed), you should not be following these instructions. You should instead be following the instructions for [How to upgrade the monitor on an existing computer](#).

1. Follow the instructions in [How to assemble your monitor hardware on page 17](#).
When Windows starts, it will automatically detect the new monitor and launch the **Found New Hardware Wizard**. Follow the prompts until it displays the option to **Install Hardware Device Drivers**.
2. Check **Search for a suitable driver for my device** option, and click **Next**.
3. Look to confirm that the wizard has selected the correct name of your monitor and click **Next**.
4. Click **Finish**.
5. Restart the computer.

How to upgrade the monitor on an existing computer

This instruction details the procedure for manually updating the existing monitor driver software on your Microsoft Windows computer. It is currently tested as compatible for Windows 10, Windows 8 (8.1), and Windows 7 Operating System (OS).



The BenQ LCD Monitor driver for your model may well function perfectly with other versions of Windows, however, as at the time of writing, BenQ has done no testing of this driver on other versions of Windows and cannot guarantee its operation on those systems.

Installing monitor driver software involves selecting an appropriate information file (.inf) from the downloaded driver files for the particular model monitor you have connected, and letting Windows install the corresponding driver files. You need only steer it in the right direction. Windows has an Upgrade Device Driver Wizard to automate the task and guide you through the file selection and installation process.

See:

- [How to install on Windows 10 system on page 27](#)
- [How to install on Windows 8 \(8.1\) system on page 28](#)
- [How to install on Windows 7 system on page 29.](#)

How to install on Windows 10 system

1. Open **Display Properties**.

Go to **Start, Settings, Devices, Devices and Printers** and right-click the name of your monitor from the menu.

2. Select **Properties** from the menu.
3. Click the **Hardware** tab.
4. Click **Generic PnP Monitor**, and then the **Properties** button.
5. Click the **Driver** tab and the **Update Driver** button.
6. In the **Update Driver Software** window, select the option **Browse my computer for driver software**.
7. Click **Browse** and locate the driver files downloaded from the Internet as instructed in [Downloading the LCD Monitor driver files from the Internet on page 24](#).
8. Click **Close**.

You may be prompted to restart your computer after the driver update is complete.

How to install on Windows 8 (8.1) system

1. Open **Display Properties**.

Move the cursor to the lower-right of the screen or press the **Windows + C** buttons on the keyboard to bring up the **Charm** bar. Go to **Settings, Control Panel, Devices and Printers** and right-click the name of your monitor from the menu.

Alternatively, right-click the desktop and select **Personalize, Display, Devices and Printers**, and right-click the name of your monitor from the menu.

2. Select **Properties** from the menu.

3. Click the **Hardware** tab.

4. Click **Generic PnP Monitor**, and then the **Properties** button.

5. Click the **Driver** tab and the **Update Driver** button.

6. In the **Update Driver Software** window, select the option **Browse my computer for driver software**.

7. Click **Browse** and locate the driver files downloaded from the Internet as instructed in [Downloading the LCD Monitor driver files from the Internet on page 24](#).

8. Click **Close**.

You may be prompted to restart your computer after the driver update is complete.

How to install on Windows 7 system

1. Open **Display Properties**.

Go to **Start, Control Panel, Hardware and Sound, Devices and Printers** and right-click the name of your monitor from the menu.

Alternatively, right-click the desktop and select **Personalize, Display, Devices and Printers**, and right-click the name of your monitor from the menu.

2. Select **Properties** from the menu.
3. Click the **Hardware** tab.
4. Click **Generic PnP Monitor**, and then the **Properties** button.
5. Click the **Driver** tab and the **Update Driver** button.
6. In the **Update Driver Software** window, select the option **Browse my computer for driver software**.
7. Click **Browse** and locate the driver files downloaded from the Internet as instructed in [Downloading the LCD Monitor driver files from the Internet on page 24](#).
8. Click **Close**.

You may be prompted to restart your computer after the driver update is complete.

How to adjust your monitor

The remote control

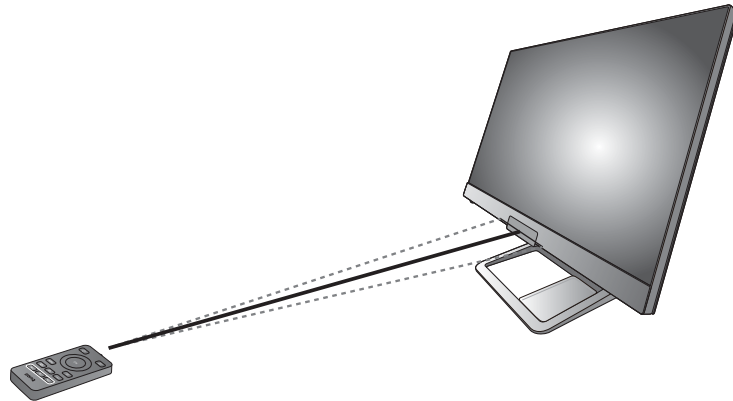

1. Follow the instructions in [Installing the battery on page 15](#) to get the remote control ready.
2. Aim the remote control at the monitor. The IR remote control sensor is located at the front of the monitor with a range of 6 meters approximately at an angle of 30 degrees (left and right) and 30 degrees (up and down). Make sure that there are not obstacles between the remote control and the IR sensor on the monitor.
3. Place the remote control holder inside the stand base frame, and put the remote control on it to access quickly.

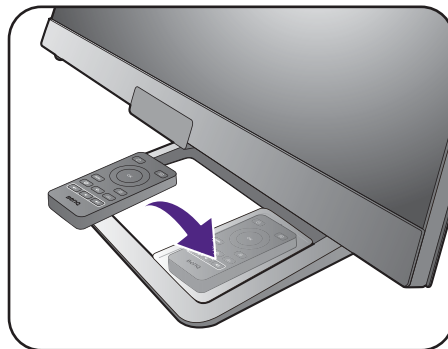

The control panel

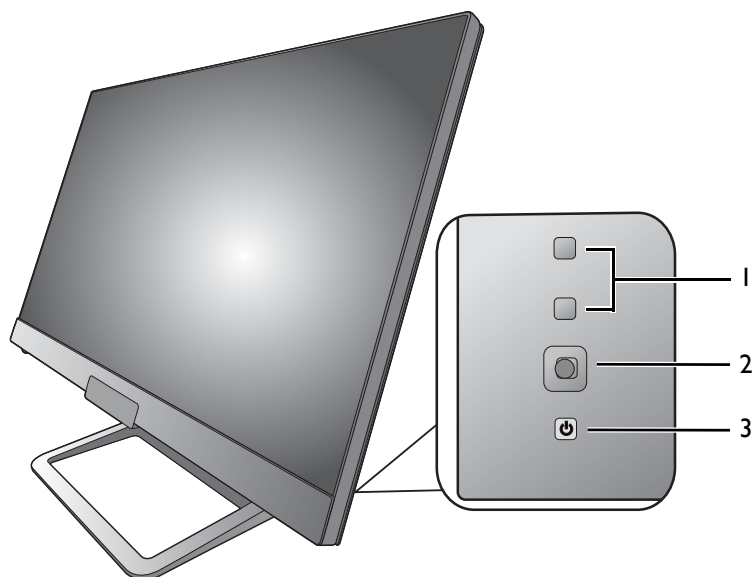





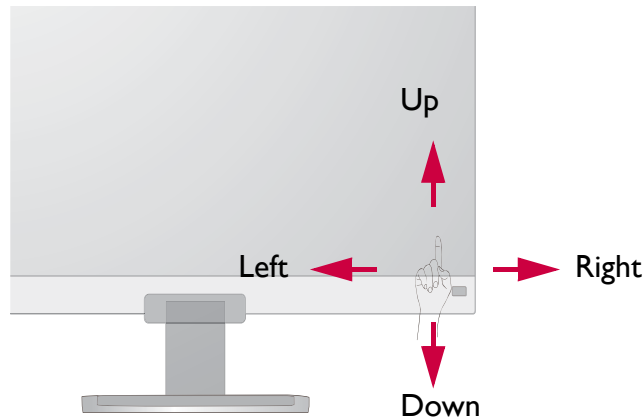

No.	Name	Description
1.	Custom keys	Accesses the functions or menu items displayed on the screen, right next to each key. See Working with the hot keys on page 34 for more information.
2.	5-way controller	Accesses the functions or menu items as instructed by the on-screen icons. See 5-way controller and basic menu operations on page 32 for more information.
3.	Power key	Turns the power on or off.

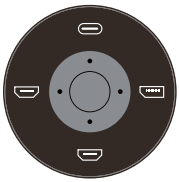
5-way controller and basic menu operations

The 5-way controller is located at the rear of the monitor. While sitting in front of the monitor, move the controller to the directions instructed by the on-screen icons for menu navigation and operations.



OSD icon	5-way controller operation	Function
(When no menu has been activated)		
N/A	Press the 5-way controller	<ul style="list-style-type: none"> • (Without video cable connection) Activates the video source selection menu. • (With video cable connection) Activates the hotkey menu.
(When the video source selection menu has been activated)		
	Move the 5-way controller to the desired direction	Switches to the desired input source.
(When the hotkey menu has been activated)		
	Move to the right	Activates the main menu.
	Move up	Adjusts brightness.
	Move down	Adjusts contrast.
	Move to the left	Closes the hotkey menu.
(When the main menu has been activated)		
	Press	Confirms the selection.
	Move to the right	<ul style="list-style-type: none"> • Enters sub menus. • Confirms the selection.
	Move up	<ul style="list-style-type: none"> • Goes to the previous menu item. • For up / increase adjustment.

OSD icon	5-way controller operation	Function
	Move down	<ul style="list-style-type: none"> • Goes to the next menu item. • For down / decrease adjustment.
	Move to the left	<ul style="list-style-type: none"> • Returns to the previous menu. • Exits OSD menu.

All OSD (On Screen Display) menus can be accessed by the control keys. You can use the OSD menu to adjust all the settings on your monitor. Available menu options may vary depending on the input sources, functions and settings.

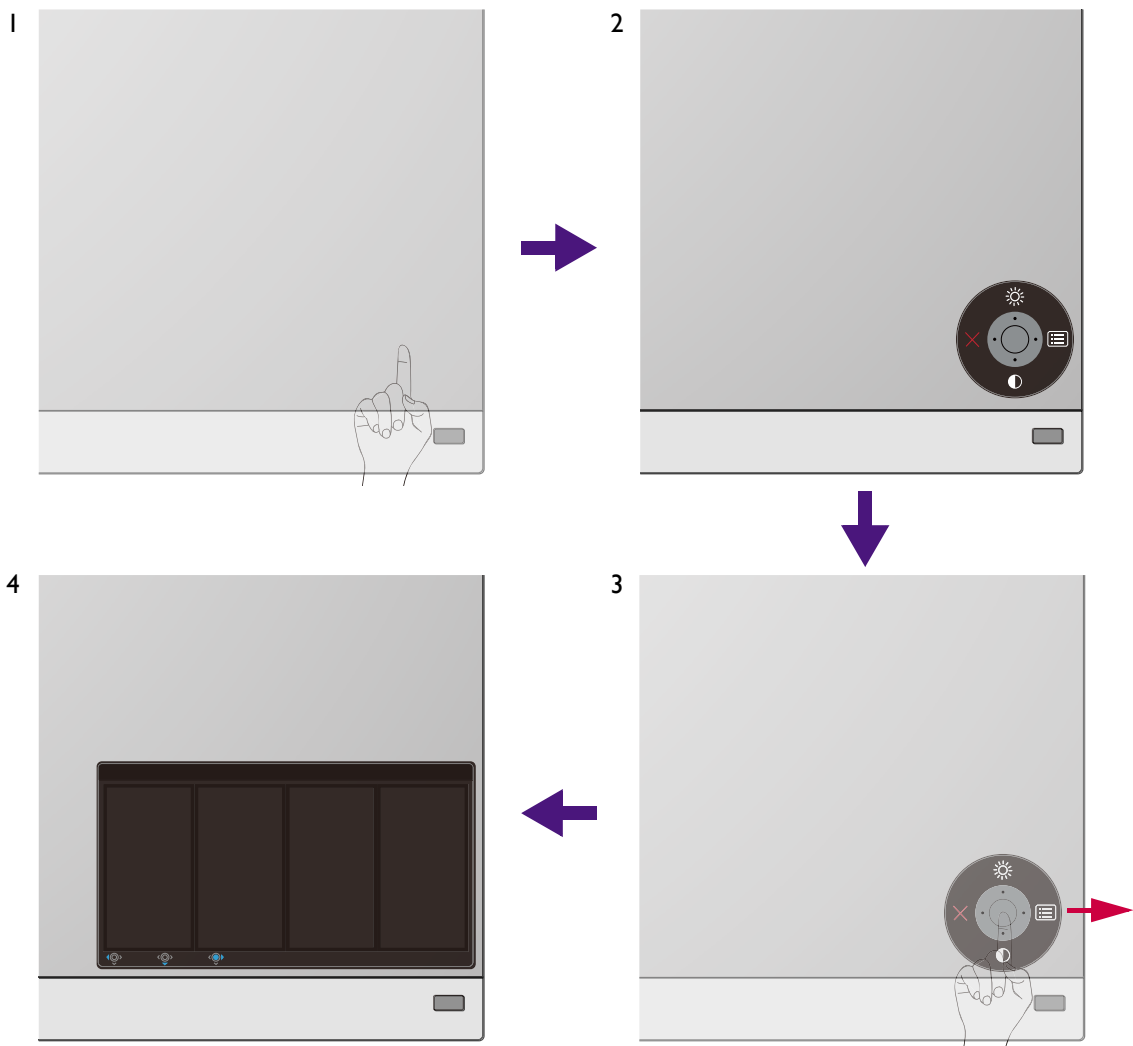

1. Press the 5-way controller.
2. The hot key menu is displayed. The top and down icons are designated for particular functions.
3. Select  (**Menu**) to access the main menu.
4. On the main menu, follow the on-screen icons on the bottom of the menu to make adjustments or selection. See [Navigating the main menu on page 40](#) for details on the menu options.



Working with the hot keys

The custom keys (located above the 5-way controller) perform as hot keys to provide direct access to pre-defined functions. You can change the default setting and designate different functions for these keys.

Accessing the hot key functions

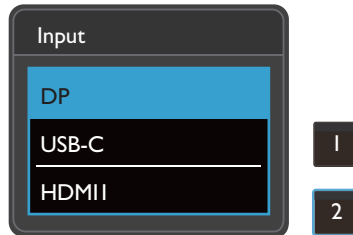
1. Press any of the custom keys on the rear of the monitor.
2. Press the key with the desired function repeatedly to cycle through available options on the list.



OSD icon	Function
	Switches to a list of Input options by default. To change the default settings, see Customizing the hot keys on page 34 .
	Switches to a list of Color Mode options by default. To change the default settings, see Customizing the hot keys on page 34 .

Customizing the hot keys

1. Press the 5-way controller to bring up the hotkey menu.
2. Select  (**Menu**) to access the main menu.
3. Go to **Custom Key**.
4. Select the custom key you want to change. It is either **Custom Key 1** or **Custom Key 2**.
5. On the sub menu, select a category.

- Under the category, check to select up to 3 items for quick access by this key.

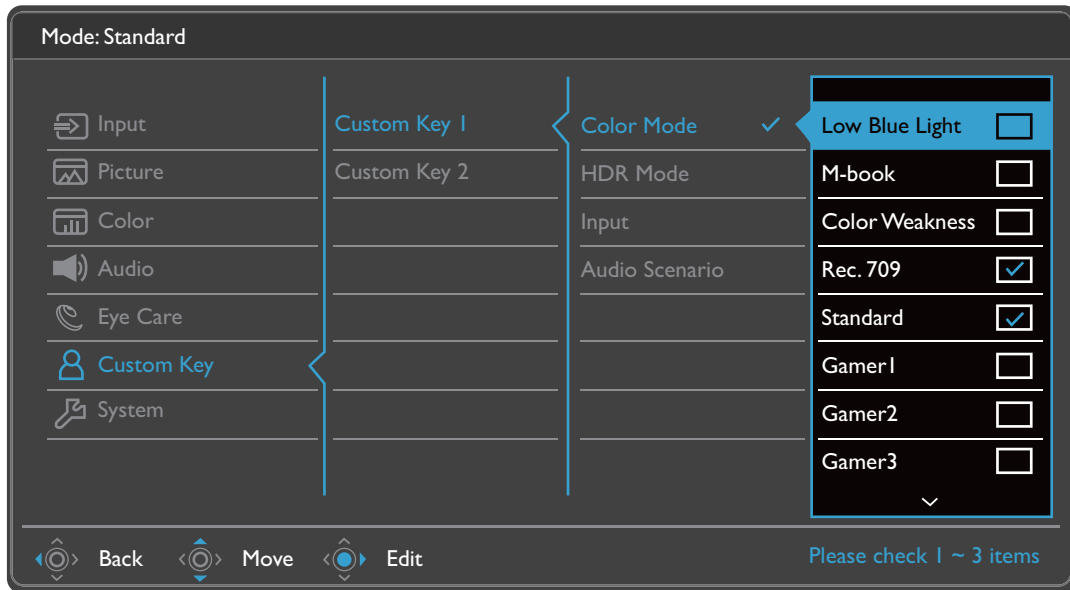

- OSD = On Screen Display.
The hot keys only operate while the main menu is not currently displaying. Hot key displays will disappear after a few seconds of no key activity.
- To unlock the OSD controls, press and hold any key for 5 seconds.

Working with the **HDR Mode** key

The monitor takes advantage of Bright Intelligence Plus technology to balance screen brightness while playing HDR content to keep all image details. You are provided with a **HDR Mode** key () on the remote control to switch to a preferred HDR setting easily.

1. Make sure HDR content is available. See [Working with HDR technology on page 36](#) for more information. HDR function is enabled automatically once HDR content is available to the monitor.
2. Press  on the remote control to bring up a list of HDR options.
3. Press the same key repeatedly to cycle through the options to the desired one. See [HDR Mode on page 45](#) for more information.

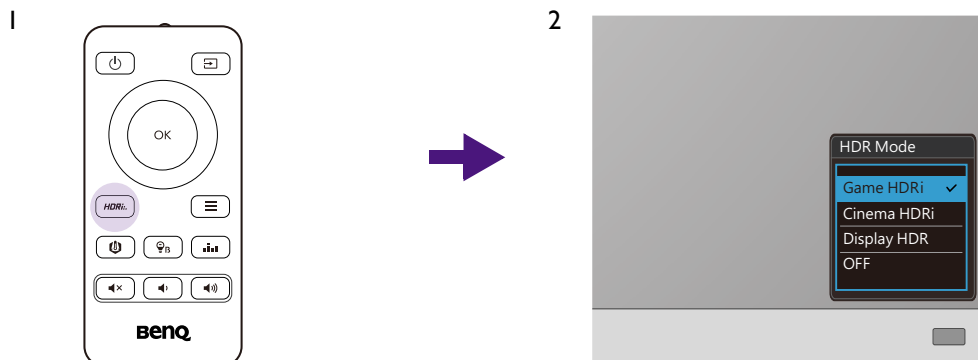

- To enable B.I+ or HDR respectively, see [Adjusting screen brightness automatically \(Bright Intelligence Plus\) on page 36](#) or [Enabling HDR function on page 37](#).

Adjusting screen brightness automatically (Bright Intelligence Plus)



The Bright Intelligence Plus function works with certain color modes only. If it is not available, its menu options will become grayed out.

The built-in light sensor works with Bright Intelligence Plus technology to detect the ambient light, image brightness, contrast, and color temperature, and then balance the screen automatically. It helps keep image details as well as to reduce eye strain.

To enable this function, press the **B.I.+** key () on the remote control. Alternatively, go to **Eye Care > B.I.+ (Bright Intelligence Plus) > ON**. It takes a few seconds to complete the adjustment.

If you select **Game HDRi** or **Cinema HDRi** from **HDR Mode**, the Bright Intelligence Plus function is enabled automatically.



The performance of Bright Intelligence Plus may be impacted by the light sources and the monitor tilt angle. You can increase the light sensor sensitivity from **Eye Care > B.I.+ (Bright Intelligence Plus) > Sensor Sensitivity** if needed. See [page 49](#) for more information.

Working with HDR technology



- Your monitor supports HDR10 technology.
- The information regarding HDR-compatible devices and content in this document is most up-to-date at the time of publication. For the latest information, contact your device manufacturer and content provider.

To enable HDR function, you need to have a compatible player and content.

1. Make sure a FHD/4K HDR player is ready. Players with the following names and resolutions are supported. Note that the 4K content on a FHD monitor get resized and is displayed at 1920 x 1080.

Commonly used names for FHD/4K (may vary by manufacturer)	FHD, 4K, 4K Ultra HD, UHD, UHD 4K, Ultra HD, 2160p
Supported resolution or modes	2560 x 1440 @ 60 Hz
Commonly used names for HDR10 (may vary by manufacturer)	HDR Premium, High Dynamic Range, HDR, Ultra HD Premium

2. Make sure HDR content is available. Content may come from a FHD/4K player.
3. Make sure the player and the monitor have been connected via an appropriate cable:
 - the provided HDMI / DP / DP to mini DP cable / USB-C™ cable (if available)
 - an HDMI cable that is HDMI High Speed or HDMI Premium certified (for models with HDMI inputs)
 - a DP / DP to mini DP cable that is DisplayPort compliance certified (for models with DP inputs)
 - a certified USB-C™ cable with DisplayPort Alternate Mode capability (for models with USB-C™ inputs)

Enabling HDR function

If the instructions in [Working with HDR technology on page 36](#) are followed and the input content is HDR-compatible, the OSD message **HDR: On** is displayed on the screen. This means your content player and content are HDR-compatible and the HDR function is properly enabled. The monitor is following the ST2084 standard to process the HDR content.

Press  on the remote control to bring up the HRD settings and select from the list. Alternatively, go to **Color > HDR Mode** for selection.

Enabling HDR-emulated mode



If the connection is complete and no OSD message is displayed, this means the content player and/or the content are not HDR-compatible. The monitor stays to the color mode recently chosen for non-HDR content. You can manually enable HDR-emulated mode by selecting **Game HDRi**, **Cinema HDRi** or **Display HDR** from **HDR Mode**.

Content type	Availability of HDR Mode options	OSD message	Availability of Color Mode options
HDR content	Game HDRi Cinema HDRi Display HDR	HDR: On	All Color Mode options are not available.
Non-HDR content	OFF	N/A	All Color Mode options are available.
	Game HDRi Cinema HDRi Display HDR	HDR: Emulated	

Adjusting volume quickly

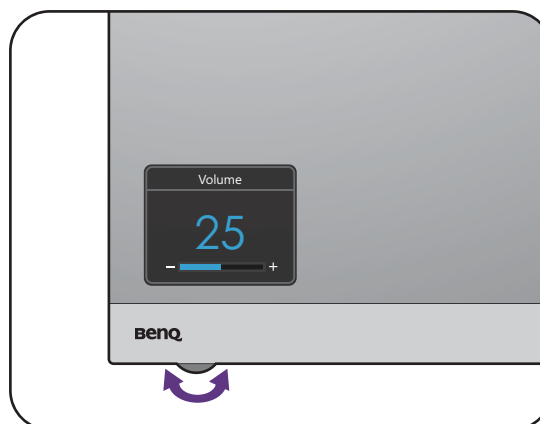
To adjust the volume quickly, turn the volume knob located at the lower-left part of the monitor. Find out the volume from the displayed adjustment bar.



Alternatively, press  /  /  on the remote control to adjust the volume.

Choosing an audio scenario

Several audio equalizers are provided for audio playback in different scenarios.

1. Press  on the remote control. Go to **Audio > Scenario**.
2. Select one option from the list. See [Scenario on page 47](#) for more information.

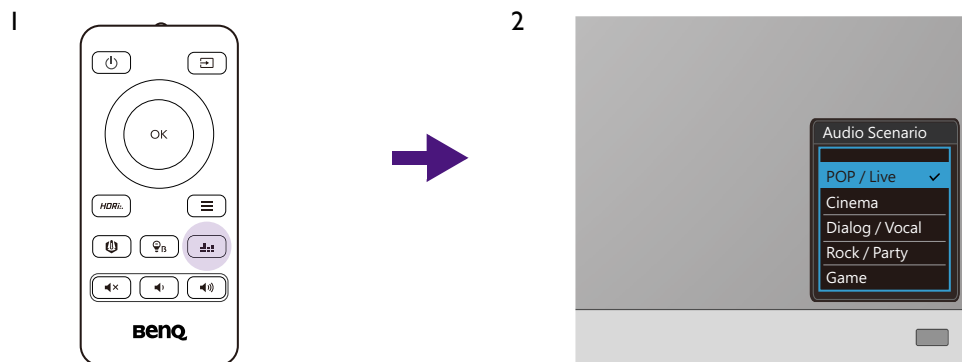

Adjusting display mode

To display images of aspect ratio other than 16:9 and size other than the panel size of your purchased model, you can adjust the display mode on the monitor.

1. Press any of the control keys to bring up the hot key menu, and press  (**Menu**) to access the main menu.
2. Go to **Picture > Advanced > Display Mode**.
3. Select an appropriate display mode. The setting will take effect immediately.

Choosing an appropriate picture mode

Your monitor provides various picture modes that are suitable for different types of images. See [Color Mode on page 44](#) for all the available picture modes.

Go to **Color > Color Mode** for a desired picture mode.

Connecting the monitor to your MacBook series product

While the monitor is connected to your MacBook series product, switch to **M-book** mode which represents MacBook's color matching and visual representation on your monitor.

1. Connect your monitor to the MacBook series product.
2. Go to **Color > Color Mode**.
3. Select **M-book**. The setting will take effect immediately.

Enabling color vision accessibility (**Color Weakness**)

Color Weakness is accessibility that helps people with color vision deficiency to distinguish colors. You are provided with **Red Filter** and **Green Filter** on this monitor. Choose one as needed.

1. Go to **Eye Care > Color Weakness**.
2. Choose either **Red Filter** or **Green Filter**.
3. Adjust the value of the filter. A stronger effect is produced as the value increases.

Activating FreeSync™ Premium

Monitors featuring with the VESA standard FreeSync will eliminate screen tearing, stuttering, and juddering during gaming.

1. Use a compatible graphics processing units (GPU) with the forthcoming driver. Confirm supported technologies please visit www.AMD.com.
2. Ensure to connect with DisplayPort or HDMI. See [Connect the PC video cable. on page 20](#) for more information.



For any questions related to FreeSync Premium performance please refer to www.AMD.com.

Working with Video Format Support technology

Your monitor supports playback of 24P videos if they were originally produced at this frame rate. With Video Format Support technology the monitor displays such videos at the correct cadence without any pulldowns to distort the source video. This function is enabled automatically if compatible content is available to the monitor.

Navigating the main menu

You can use the OSD (On Screen Display) menu to adjust all the settings on your monitor.

Press any of the control keys to bring up the hot key menu, and press  (**Menu**) to access the main menu. See [5-way controller and basic menu operations on page 32](#) for details.

Available menu options may vary depending on the input sources, functions and settings. Menu options that are not available will become grayed out. And keys that are not available will be disabled and the corresponding OSD icons will disappear. For models without certain functions, their settings and related items will not appear on the menu.



The OSD menu languages may differ from the product supplied to your region, see [Language on page 53](#) under **System** and **OSD Settings** for more details.









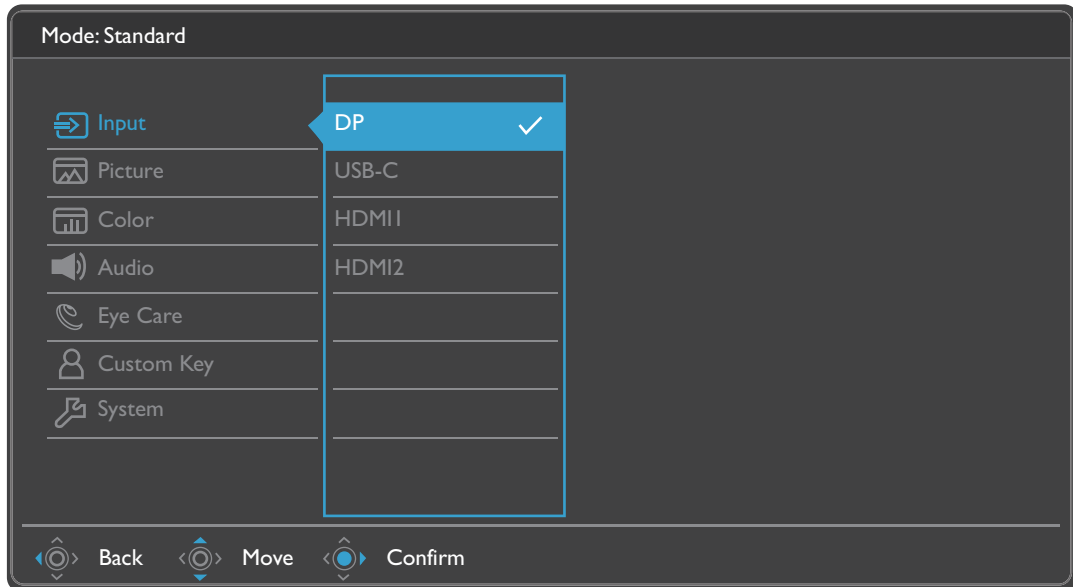

For more information on each menu, please refer to the following pages:

- [Input menu on page 41](#)
- [Picture menu on page 42](#)
- [Color menu on page 44](#)
- [Audio menu on page 47](#)
- [Eye Care menu on page 49](#)
- [Custom Key menu on page 51](#)
- [System menu on page 52](#)

Input menu

Available menu options may vary depending on the input sources, functions and settings. Menu options that are not available will become grayed out. And keys that are not available will be disabled and the corresponding OSD icons will disappear. For models without certain functions, their settings and related items will not appear on the menu.











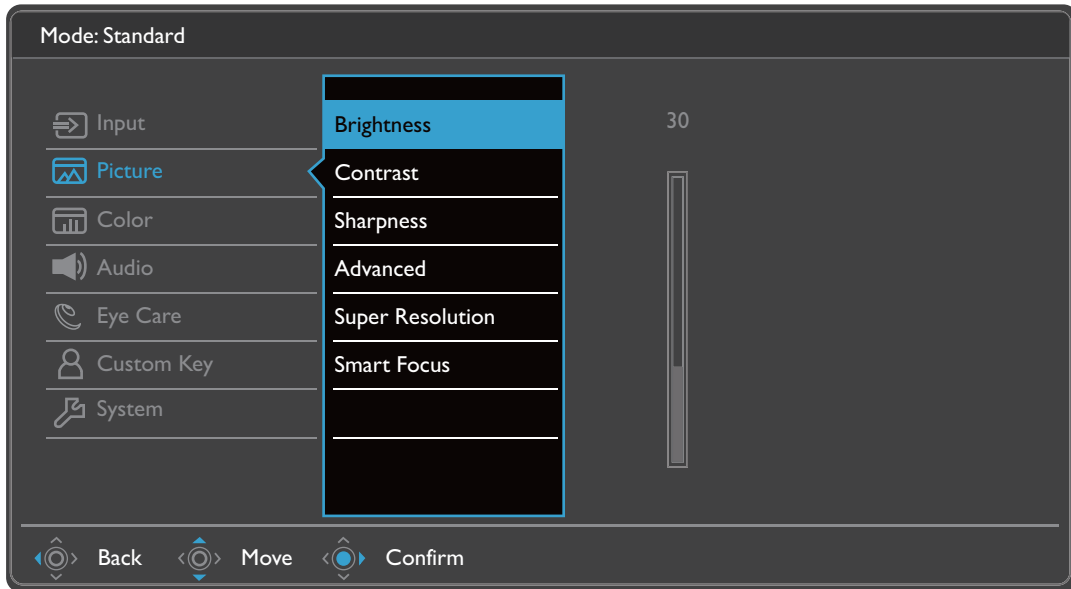



1. Select  (**Menu**) from the hot key menu.
2. Use  or  to select **Input**.
3. Select  to go to a sub menu, and then use  or  to select a menu item.
4. Use  or  to make adjustments, or use  to make selection.
5. To return to the previous menu, select .
6. To exit the menu, select .

Item	Function	Range
Input	Use this to change the input to that appropriate to your video cable connection type.	•DP •USB-C •HDMI1 •HDMI2



Picture menu

Available menu options may vary depending on the input sources, functions and settings. Menu options that are not available will become grayed out. And keys that are not available will be disabled and the corresponding OSD icons will disappear. For models without certain functions, their settings and related items will not appear on the menu.



1. Select  (**Menu**) from the hot key menu.
2. Use  or  to select **Picture**.
3. Select  to go to a sub menu, and then use  or  to select a menu item.
4. Use  or  to make adjustments, or use  to make selection.
5. To return to the previous menu, select .
6. To exit the menu, select .









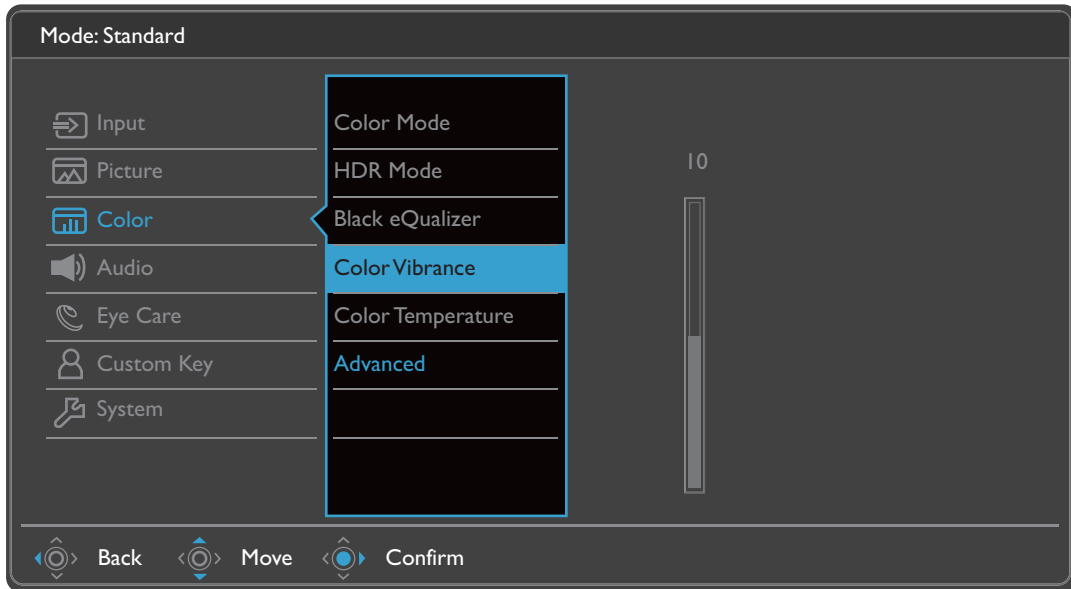

Item	Function		Range
Brightness	Adjusts the balance between light and dark shades.		0 to 100
Contrast	Adjusts the degree of difference between darkness and lightness.		0 to 100
Sharpness	Adjusts the clarity and visibility of the edges of the subjects in the image.		1 to 10
Advanced	Dynamic Contrast	The function is to automatically detect the distribution of an input visual signal, and then to create the optimal contrast.	0 to 5

Item	Function		Range
Display Mode	<p>This feature is provided to allow aspect ratios other than 16:9 to be displayed without geometric distortion.</p> <p> The options under Display Mode will be different depending on the input signal sources.</p> <p> Depending on your selection of Color Mode, different Display Mode option is pre-set. Change the setting if needed.</p>		
	Full	Scales the input image to fill the screen. Ideal for 16:9 aspect images.	
	Aspect	The input image is displayed without geometric distortion filling as much of the display as possible.	
	1:1	Displays the input image in its native resolution without scaling.	
	Overscan	<p>Slightly enlarges the input image. Use this feature to hide annoying edge noise if present around your image.</p> <p> Available only when the input source is HDMI.</p>	<ul style="list-style-type: none"> • ON • OFF
Super Resolution	Simulates high-resolution images by increasing pixel density of low resolution ones.		<ul style="list-style-type: none"> • 0 • 1 • 2 • 3
Smart Focus	This feature provides a highlight area to focus on certain content, e.g. a YouTube video or a game in windowed mode.		
	Size	Determines the size of the highlight area.	<ul style="list-style-type: none"> • Small • Large • OFF
	H. Position	Adjusts the horizontal position of the highlight area.	0 ~ 100
	V. Position	Adjusts the vertical position of the highlight area.	0 ~ 100
	Scaling	Scales the highlight area.	0 ~ 100



Color menu

Available menu options may vary depending on the input sources, functions and settings. Menu options that are not available will become grayed out. And keys that are not available will be disabled and the corresponding OSD icons will disappear. For models without certain functions, their settings and related items will not appear on the menu.



1. Select  (**Menu**) from the hot key menu.
2. Use  or  to select **Color**.
3. Select  to go to a sub menu, and then use  or  to select a menu item.
4. Use  or  to make adjustments, or use  to make selection.
5. To return to the previous menu, select .
6. To exit the menu, select .

Item	Function	Range
Color Mode	Select a color mode that best suits the type of images shown on the screen.	
	Low Blue Light Decreases the blue light emitted from the display to reduce the risk of blue light exposure to your eyes.  There are 5 low blue light modes to suit different needs. To select a desired mode, go to Eye Care > Low Blue Light . See Low Blue Light on page 50 for more information.	
	Rec. 709 For better color matching representation with Standard Rec. 709.	









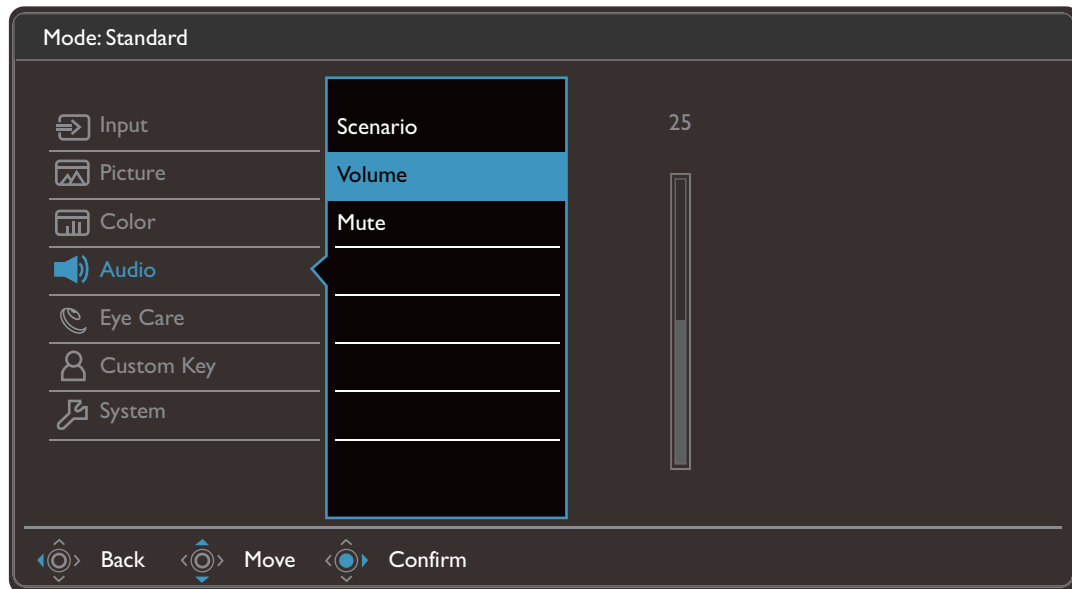

Item	Function		Range
	Color Weakness	<p>Adjusts color matching representation for people with color vision deficiency to distinguish colors easily.</p>  <p>You are provided with Red Filter and Green Filter on this monitor. Go to Eye Care > Color Weakness and choose one as needed. See Color Weakness on page 45 for more information.</p>	
	M-book	Minimizes the visual differences between the monitor and the connected MacBook series product.	
	Standard	For basic PC application.	
	Gamer1	For playing CS: GO games.	
	Gamer2	For playing Battlefield games.	
	Gamer3	For playing car racing games.	
	User	Applies a combination of picture settings defined by users.	
HDR Mode	Select an HDR mode that best suits the images displayed in the surrounding light condition.		
	Game HDRi	Enables HDR and B.I.+ functions at the same time while the contrast is enhanced.	
	Cinema HDRi	Enables HDR and Bright Intelligence functions together.	
	Display HDR	Enables HDR function.	
	OFF	Switches HDR mode off.	
Black eQualizer	<p>Brings out the dark shades by increasing the brightness without changing those of the light shades.</p>  <p>If the image is too bright or barely contains any dark shades, adjusting the value of Black eQualizer may not show much change to the image.</p>		0 ~ 20
Color Vibrance	Provides different sets of color settings. Once applied, you can adjust some of the color settings in the corresponding menus.		0 ~ 20

Item	Function		Range
Color Temperature	Normal	Allows video and still photographs to be viewed with natural coloring. This is the factory default color.	
	Bluish	Applies a cool tint to the image and is factory pre-set to the PC industry standard white color.	
	Reddish	Applies a warm tint to the image and is factory pre-set to the news print standard white color.	
	User Define	The blend of the Red, Green and Blue primary colors can be altered to change the color tint of the image. Go to the succeeding R (red), G (green), and B (blue) menus to change the settings. Decreasing one or more of the colors will reduce their respective influence on the color tint of the image. (e.g. if you reduce the Blue level the image will gradually take on a yellowish tint. If you reduce Green, the image will become a magenta tint.)	<ul style="list-style-type: none"> • R (0~100) • G (0~100) • B (0~100)
Advanced	Gamma	Adjusts the tone luminance. The default value is 2.2 (the standard value for Windows).	<ul style="list-style-type: none"> • 1.8 • 2.0 • 2.2 • 2.4 • 2.6
	Reset Color	Resets the custom color settings to the factory defaults.	<ul style="list-style-type: none"> • YES • NO
	AMA	Improves the gray level response time of the LCD panel.	<ul style="list-style-type: none"> • OFF • High • Premium
	RGB PC Range	Determines the range of color scales. Select an option that matches the RGB range setting on the connected device.	<ul style="list-style-type: none"> • Auto Detect • RGB (0~255) • RGB (16~235)

Audio menu

Available menu options may vary depending on the input sources, functions and settings. Menu options that are not available will become grayed out. And keys that are not available will be disabled and the corresponding OSD icons will disappear. For models without certain functions, their settings and related items will not appear on the menu.



1. Select  (**Menu**) from the hot key menu.
2. Use  or  to select **Audio**.
3. Select  to go to a sub menu, and then use  or  to select a menu item.
4. Use  or  to make adjustments, or use  to make selection.
5. To return to the previous menu, select .
6. To exit the menu, select .









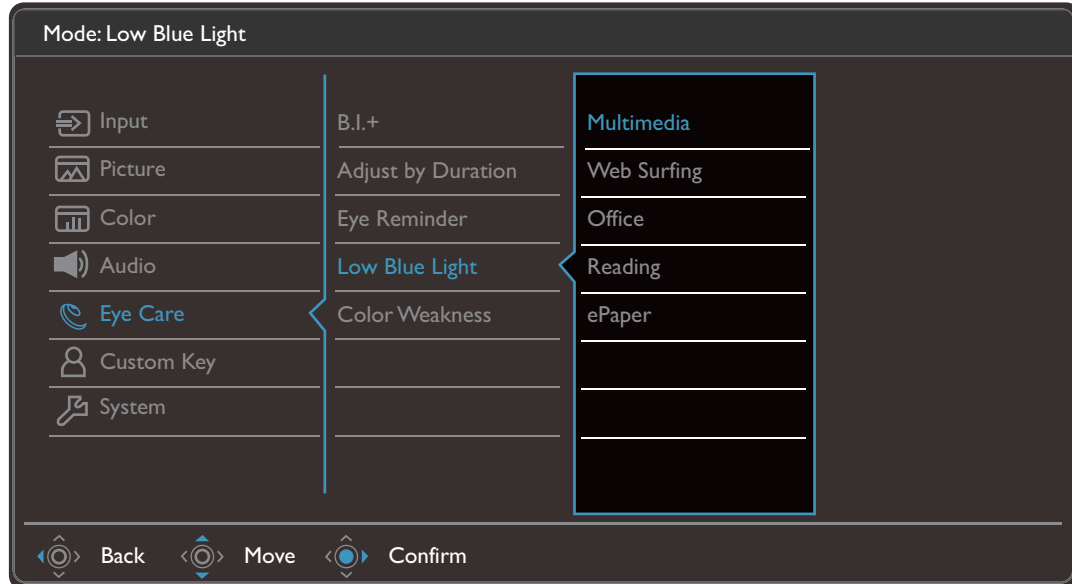

Item	Function	Range
Scenario	Selects one of the equalizers to obtain the best audio effect in certain scenarios.	
	Live / Pop Keeps the music and the vocal in harmony as if in live.	
	Cinema Enhances the bass while keeps the vocal clear.	
	Dialog / Vocal Cancels noise to improve sound clarity.	
	Game Enhances the sound positioning so you can identify the location or origin of detailed sounds, e.g., a flying bullet or an enemy's footsteps.	

Item	Function		Range
	Rock / Party	Enables 3D surrounding effect and beat booster.	
Volume	Adjusts the audio volume.		0 ~ 50
Mute	Mutes the audio input.		<ul style="list-style-type: none"> • ON • OFF

Eye Care menu

Available menu options may vary depending on the input sources, functions and settings. Menu options that are not available will become grayed out. And keys that are not available will be disabled and the corresponding OSD icons will disappear. For models without certain functions, their settings and related items will not appear on the menu.



1. Select  (**Menu**) from the hot key menu.
2. Use  or  to select **Eye Care**.
3. Select  to go to a sub menu, and then use  or  to select a menu item.
4. Use  or  to make adjustments, or use  to make selection.
5. To return to the previous menu, select .
6. To exit the menu, select .









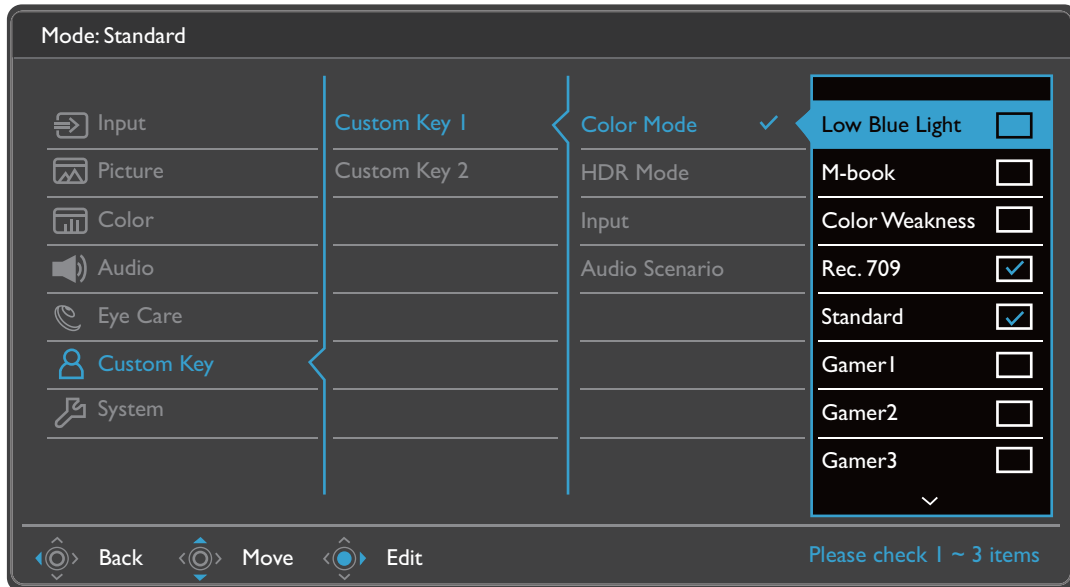

Item	Function	Range	
B.I.+ (Bright Intelligence Plus)	Turns the Bright Intelligence Plus function on or off. The built-in light sensor works with Bright Intelligence Plus technology to detect the ambient light, image brightness, contrast, and color temperature, and then balance the screen automatically.	<ul style="list-style-type: none"> • ON • OFF 	
	Light Meter	Sets to display the light condition around the monitor on the screen.	<ul style="list-style-type: none"> • ON • OFF
	Sensor Sensitivity	Adjusts sensitivity of light sensor to change the brightness range to be detected. This may be helpful to correct uneven lighting in light detection.	0 ~ 100

Item	Function	Range	
Adjust by Duration	The color temperature of the monitor changes as the usage time increases to reduce possible eye strain.	<ul style="list-style-type: none"> • ON • OFF 	
Eye Reminder	Allows the built-in proximity sensor to detect your presence within the range of approximately 90 cm. If the sensor detects your presence for more than the set period of time, the monitor displays a pop-up message that reminds you to rest your eyes.	<ul style="list-style-type: none"> • OFF • 30 min • 45 min • 60 min 	
Low Blue Light	<p>Decreases the blue light emitted from the display to reduce the risk of blue light exposure to your eyes.</p>  <p>The amount of blue light reduced in each low blue light mode varies and has been set particularly for the specified scenario. Choose one mode to suit your needs.</p>		
	Multimedia	For viewing multimedia files.	
	Web Surfing	For web surfing.	
	Office	For office works or office environment.	
	Reading	For reading e-books or documents.	
	ePaper	For reading e-books or documents in black and white with suitable on-screen brightness and clear texts.	
Color Weakness	Adjusts color matching representation for people with color vision deficiency to distinguish colors easily.		
	Red Filter	Decides the effect produced by the red filter. A stronger effect is produced as the value increases.	0 ~ 20
	Green Filter	Decides the effect produced by the green filter. A stronger effect is produced as the value increases.	0 ~ 20

Custom Key menu

Available menu options may vary depending on the input sources, functions and settings. Menu options that are not available will become grayed out. And keys that are not available will be disabled and the corresponding OSD icons will disappear. For models without certain functions, their settings and related items will not appear on the menu.











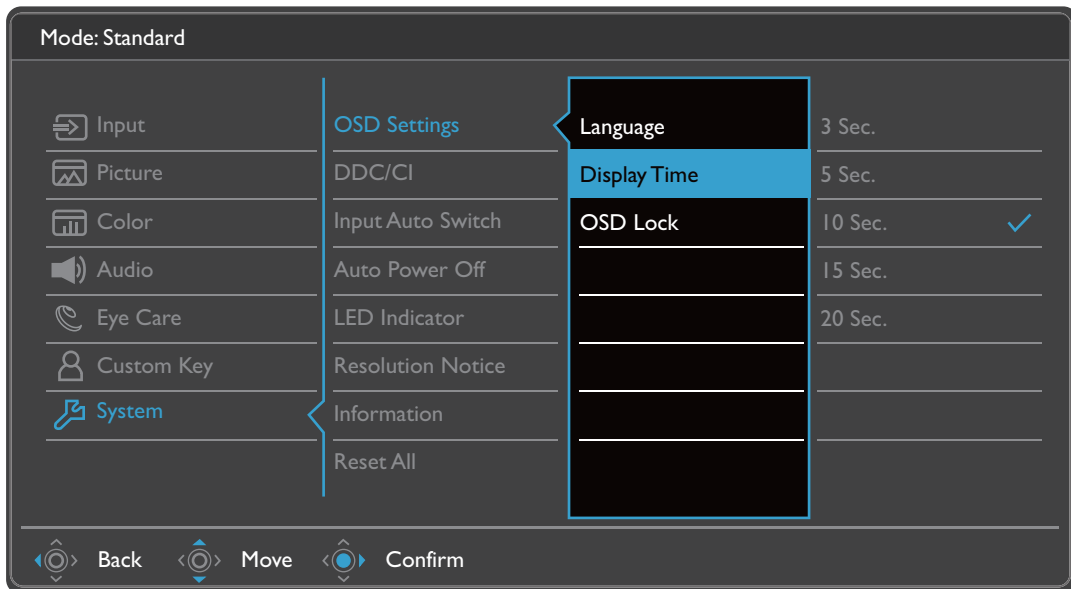



1. Select  (**Menu**) from the hot key menu.
2. Use  or  to select **Custom Key**.
3. Select  to go to a sub menu, and then use  or  to select a menu item.
4. Use  or  to make adjustments, or use  to make selection.
5. To return to the previous menu, select .
6. To exit the menu, select .



Item	Function	Range
Custom Key 1	Sets the function to be accessed by custom key 1. Select a category first, and choose up to 3 options to be accessed by this key.	<ul style="list-style-type: none"> • Color Mode • HDR Mode • Input • Audio Scenario
Custom Key 2	Sets the function to be accessed by custom key 2. Select a category first, and choose up to 3 options to be accessed by this key.	

System menu

Available menu options may vary depending on the input sources, functions and settings. Menu options that are not available will become grayed out. And keys that are not available will be disabled and the corresponding OSD icons will disappear. For models without certain functions, their settings and related items will not appear on the menu.



1. Select  (**Menu**) from the hot key menu.
2. Use  or  to select **System**.
3. Select  to go to a sub menu, and then use  or  to select a menu item.
4. Use  or  to make adjustments, or use  to make selection.
5. To return to the previous menu, select .
6. To exit the menu, select .

















Item	Function		Range
OSD Settings	Language	Sets the OSD menu language.  The language options displayed on your OSD may differ from those shown on the right, depending on the product supplied in your region.	<ul style="list-style-type: none"> • English • Français • Deutsch • Italiano • Español • Polski • Česky • Magyar • Română • Nederlands • Русский • Svenska • Português • العربية • 日本語 • 한국어 • 繁體中文 • 简体中文
	Display Time	Adjusts the display time of the OSD menu.	<ul style="list-style-type: none"> • 3 sec. • 5 sec. • 10 sec. • 15 sec. • 20 sec.
	OSD Lock	Prevents all the monitor settings from being accidentally changed. When this function is activated, the OSD controls and hotkey operations will be disabled.  To unlock the OSD controls, press and hold any key for 5 seconds.	
DDC/CI	Allows the monitor settings to be set through the software on the PC.  DDC/CI, short for Display Data Channel/Command Interface, which was developed by Video Electronics Standards Association (VESA). DDC/CI capability allows monitor controls to be sent via the software for remote diagnostics.		<ul style="list-style-type: none"> • ON • OFF
Input Auto Switch	Once enabled, the specific port will be in the input auto select loop. Otherwise, it can only be selected by input select or by hot key.		<ul style="list-style-type: none"> • ON • OFF

Item	Function	Range
Auto Power Off	Sets the time to power off the monitor automatically in power saving mode.	<ul style="list-style-type: none"> • OFF • 10 min • 20 min • 30 min
LED Indicator	Switches the power key's LED indicator on or off.	<ul style="list-style-type: none"> • ON • OFF
Resolution Notice	Sets whether to display the resolution notice of the recommended resolution when a new input source is detected by the monitor.	<ul style="list-style-type: none"> • ON • OFF
Information	Displays the product information.	<ul style="list-style-type: none"> • Input • Current Resolution • Optimum Resolution • HDR • Model Name
Reset All	Resets all mode, color and geometry settings to the factory default values.	<ul style="list-style-type: none"> • YES • NO

Troubleshooting

Frequently asked questions (FAQ)

Imaging

-  The image is blurred.
-  Download **Resolution file** from the website (see [Product support on page 3](#)). Refer to "**Adjusting the Screen Resolution**". And then select the correct resolution, refresh rate and make adjustments based on these instructions.
-  Does the blurring only occur at resolutions lower than the native (maximum) resolution?
-  Download **Resolution file** from the website (see [Product support on page 3](#)). Refer to "**Adjusting the Screen Resolution**". Select the native resolution.
-  Pixel errors can be seen.
- One of several pixels is permanently black, one or more pixels are permanently white, one or more pixels are permanently red, green, blue or another color.
-  • Clean the LCD screen.
-  • Cycle power on-off.
-  • These are pixels that are permanently on or off and is a natural defect that occurs in LCD technology.
-  The image has a faulty coloration.
-  It has a yellow, blue or pink appearance.
-  Go to **Color > Advanced > Reset Color**, and then choose **YES** to reset the color settings to the factory defaults.
- If the image is still not correct and the OSD also has faulty coloration, this means one of the three primary colors is missing in the signal input. Now check the signal cable connectors. If any pin is bent or broken off, please contact your dealer to get necessary support.
-  The image is distorted, flashes or flickers.
-  Download **Resolution file** from the website (see [Product support on page 3](#)). Refer to "**Adjusting the Screen Resolution**". And then select the correct resolution, refresh rate and make adjustments based on these instructions.
-  You are running the monitor at its native resolution, but the image is still distorted.
-  Images from different input sources may appear distorted or stretched on the monitor running at its native resolution. To have the optimal display performance of each type of input sources, you can use the **Display Mode** function to set a proper aspect ratio for the input sources. See [Display Mode on page 43](#) for details.
-  The image is displaced in one direction.
-  Download **Resolution file** from the website (see [Product support on page 3](#)). Refer to "**Adjusting the Screen Resolution**". And then select the correct resolution, refresh rate and make adjustments based on these instructions.

? Faint shadow from the static image displayed is visible on the screen.

- ✓ • Activate the power management function to let your computer and monitor go into a low power "sleep" mode when not actively in use.
- Use a screensaver to prevent the occurrence of image retention.

Power LED indicator

? The LED indicator is white or orange.

- ✓ • If the LED lights up in solid white, the monitor is powered on.
- If the LED is illuminated in white and there is a message **Out of Range** on the screen, this means you are using a display mode that this monitor does not support, please change the setting to one of the supported mode. Download **Resolution file** from the website (see [Product support on page 3](#)). Refer to "**Adjusting the Screen Resolution**". And then select the correct resolution, refresh rate and make adjustments based on these instructions.
- If the LED is illuminated in orange, the power management mode is active. Press any button on the computer keyboard or move the mouse. If that does not help, check the signal cable connectors. If any pin is bent or broken off, please contact your dealer to get necessary support.
- If the LED is off, check the power supply mains socket, the external power supply and the mains switch. Turn on the LED indicator from **System > LED Indicator**.

OSD controls

? The OSD controls are inaccessible.

- ✓ • To unlock the OSD controls when it is preset to be locked, press and hold any key for 5 seconds.

OSD messages

? A message **Out of Range** on the screen during computer boot up process.

- ✓ • If there is a message **Out of Range** on the screen during computer boot up process, this means computer compatibility caused by operating system or graphic card. The system will adjust the refresh rate automatically. Just wait until the operating system is launched.

Audio

? No sound can be heard from the built-in speakers.

- ✓ • Check whether the desired cable to input audio signals is properly connected. See [Connect the audio cable. on page 20](#) for details.
- Increase the volume (volume may be muted or too low).
- Remove your headphone and/or external speakers. (If they are connected to the monitor, the built-in speakers are automatically muted.)

? No sound can be heard from the connected external speakers.

- ✓
 - Remove your headphone (if the headphone is connected to the monitor).
 - Check whether the headphone jack is properly connected.
 - If the external speakers are USB-powered, check whether the USB connection is OK.
 - Increase the volume (volume may be muted or too low) on the external speakers.
 - If USB-C™ connection is established, make sure the appropriate audio output setting on your laptop has been selected. You may look for options similar to "USB headphone."

Sensors

? The light sensor of the monitor does not work well.

- ✓ The light sensor is located at the front bottom of the monitor. Please check:
 - If you have removed the sensor protection sticker.
 - If the Bright Intelligence / Bright Intelligence Plus function has been turned on. Check **Eye Care > B.I.+** (Bright Intelligence Plus).
 - If there are any obstacles in front of the sensor that keep the sensor from detecting the light properly.
 - If there are any objects or clothing in bright colors in front of the sensor. Bright colors (especially white and fluorescent colors) reflect light and the sensor cannot detect the main light sources.

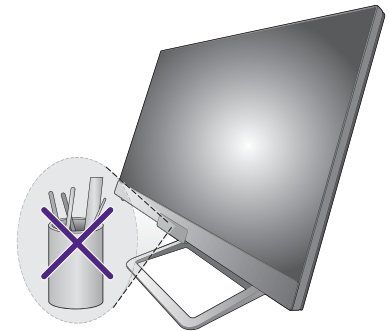

HDR

? There is a message **HDR: Emulated** showing on the screen.

- ✓ This means the input content is not HDR-compatible and the monitor is in HDR-emulated mode. Refer to [Working with HDR technology on page 36](#) to check if a supported player, content, and the certified cable are used.

USB-C™ connection (models with USB-C™ ports)

? No video or audio output from the laptop with USB-C™ connection.

- ✓ Check the cable connections and menu settings in the following order:
 - Check if the USB-C™ cable has been connected to the monitor and the laptop properly. See [Connect the PC video cable. on page 20](#) for more information.
 - Check if the input source has been selected to **USB-C** from **Input**.

Remote control



The monitor does not respond to the remote control.



- Check if the remote control and the monitor are within the effective range and there are no obstacles between them. See [The remote control on page 30](#) for more information.
- The remote control's battery is running low. Replace the battery with a new one. See [Installing the battery on page 15](#) for more information.
- Check if the OSD controls are locked. To unlock the OSD controls, press and hold any key on the rear of the monitor for 5 seconds.

Need more help?

If your problems remain after checking this manual, please contact your place of purchase or visit the local website from Support.BenQ.com for more support and local customer service.