



LCD Monitor Quick Start Guide

Business Monitor | BL Series

DN: BL80-EQ-V1

© 2021 BenQ Corporation. All rights reserved. Rights of modification reserved.

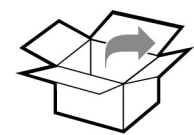
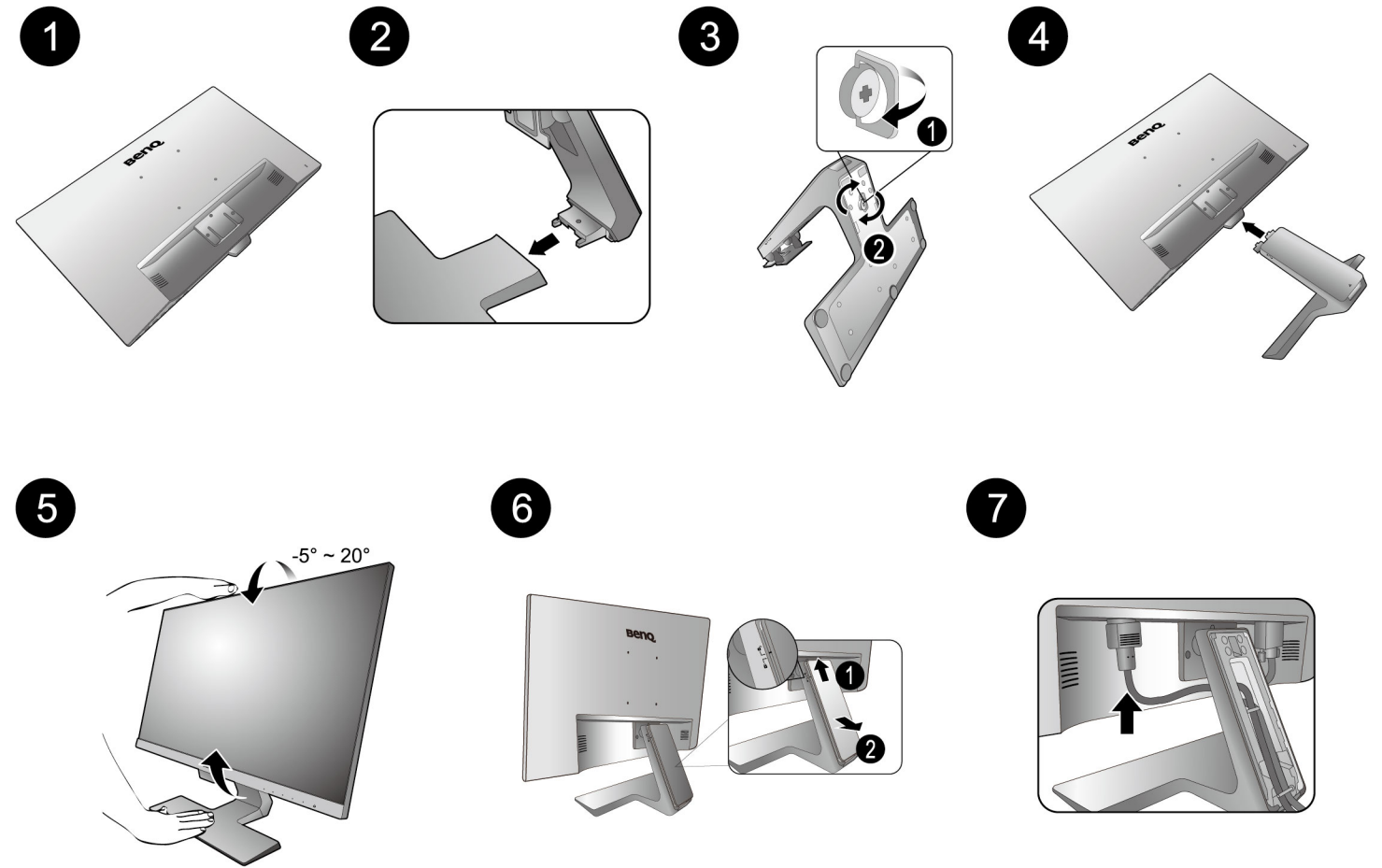

or

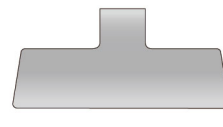

D-Sub
(Optional)



DVI-D
(Optional)



DP
(Optional)

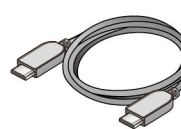

HDMI
(Optional)



Audio
(Optional)

8 Video

9 Audio

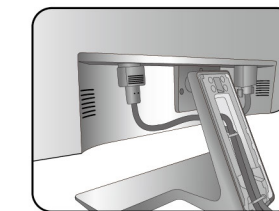

BL2480 / BL2780

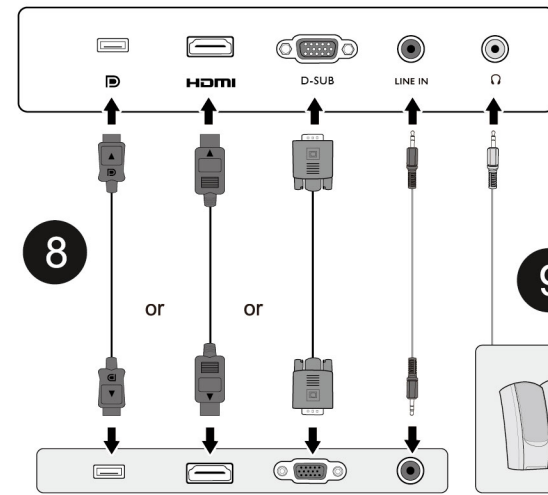

BL2283

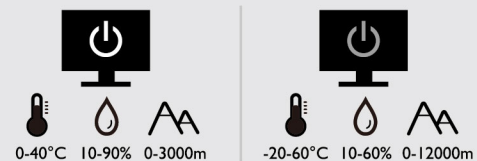
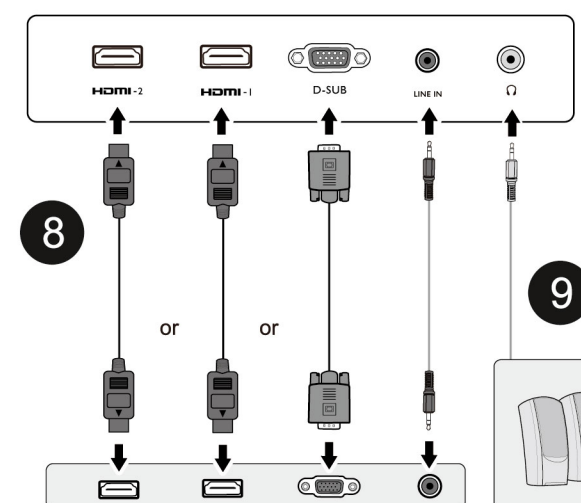

8 Video

9 Audio

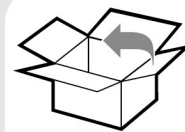
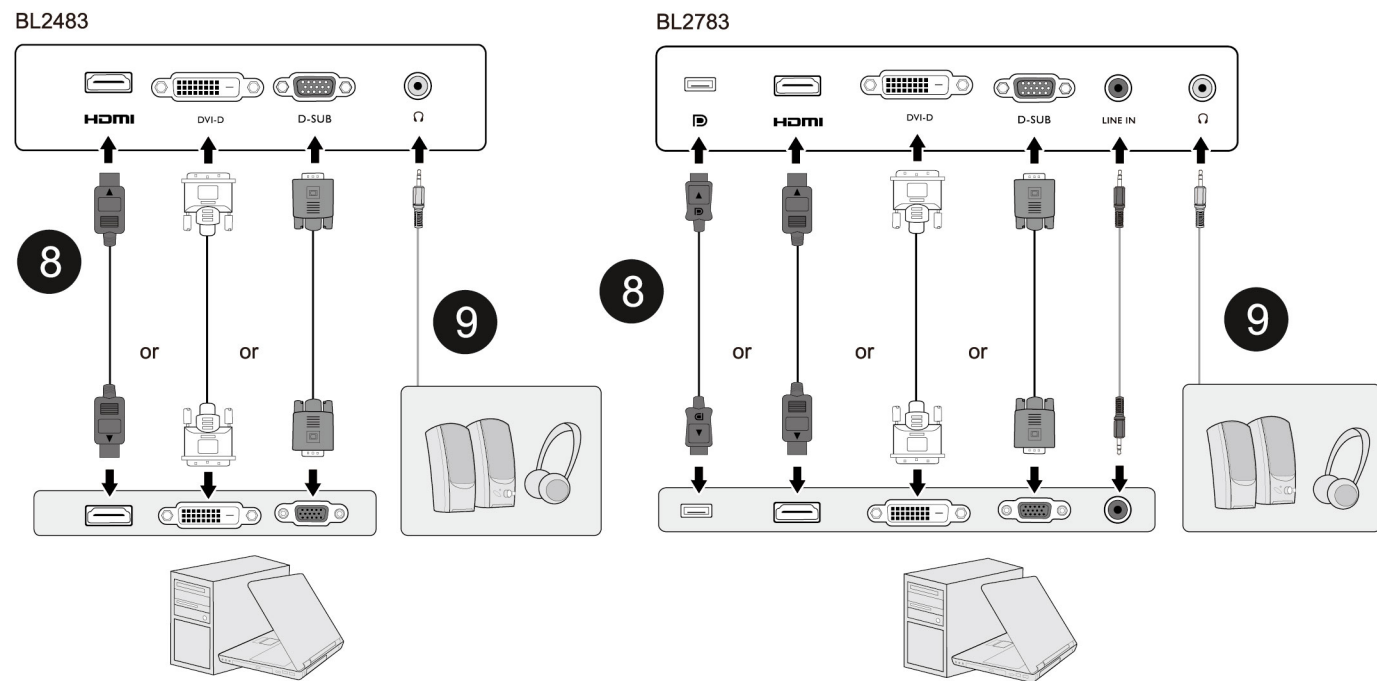
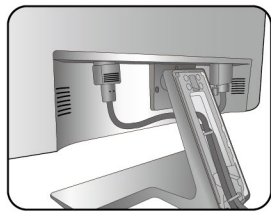

1



2

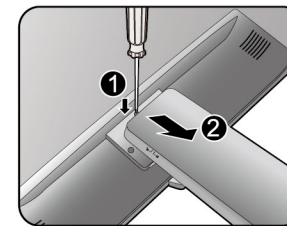

3

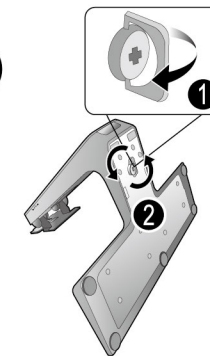

4

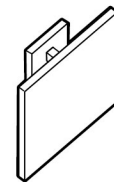
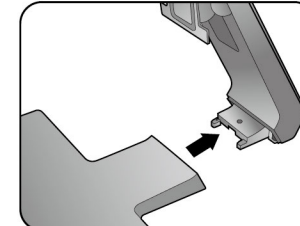

1

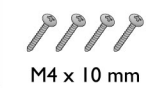

2

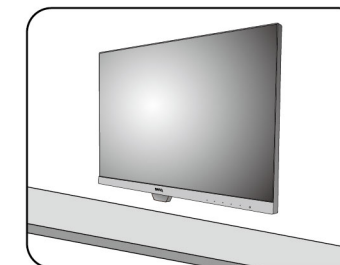

10

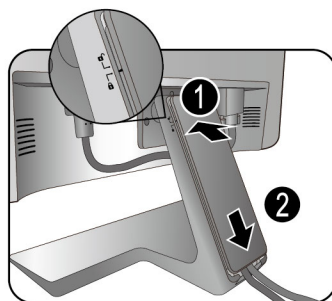

11

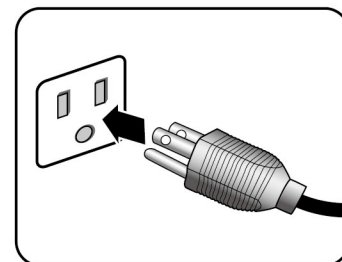

12

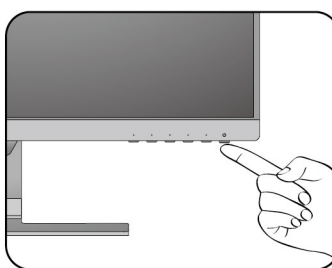

13

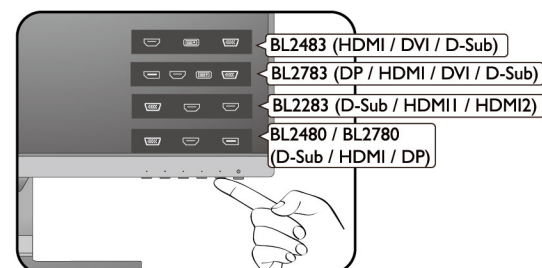

Support.BenQ.com



Online Manual



Product Support



Software Download