



LCD Monitor Quick Start Guide

DesignVue Designer Monitor | PD Series



DN: PD05Q-EQ-V1

© 2021 BenQ Corporation. All rights reserved. Rights of modification reserved.

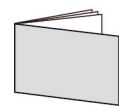
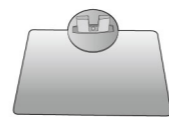
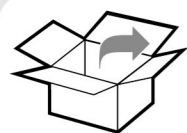

USB



USB-C™



DP



HDMI
(optional)

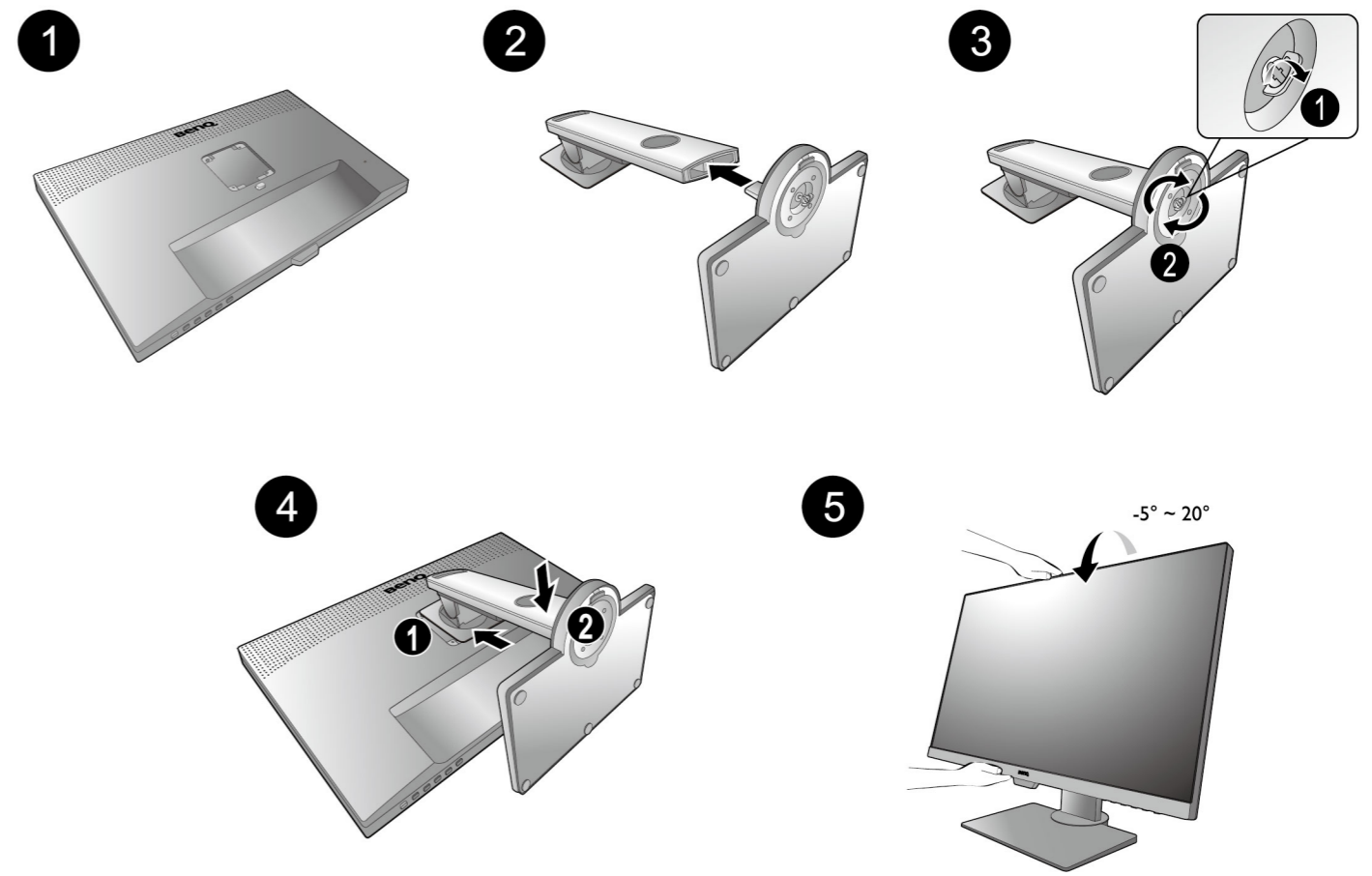
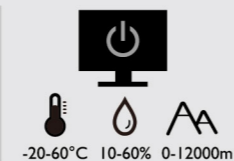
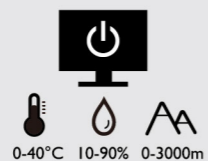

- 6 Video
- 7 Audio
- 8 USB

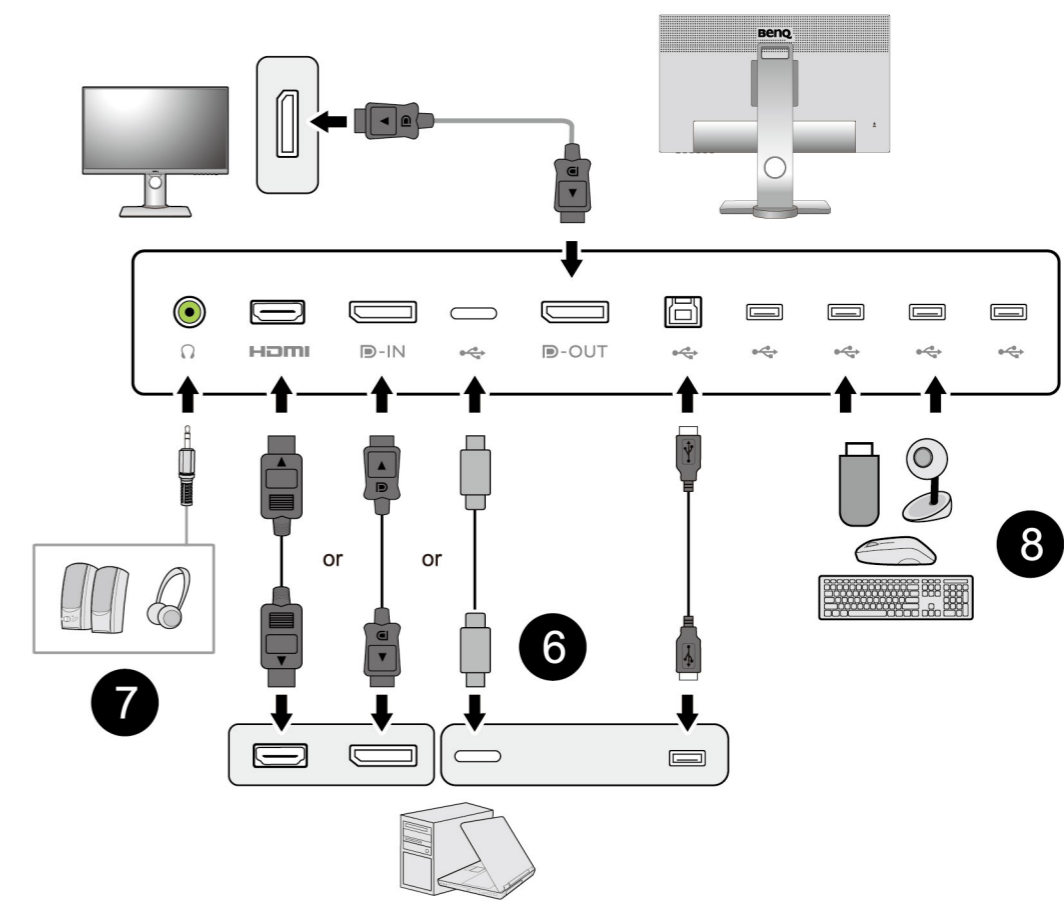

9

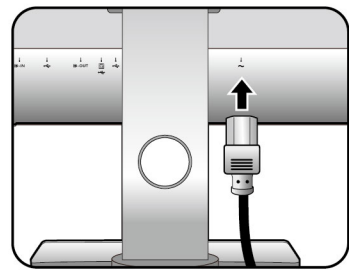

10

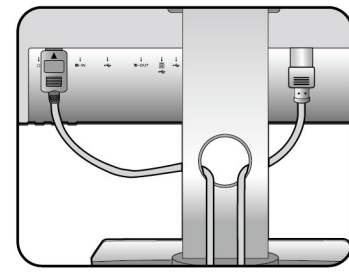

11

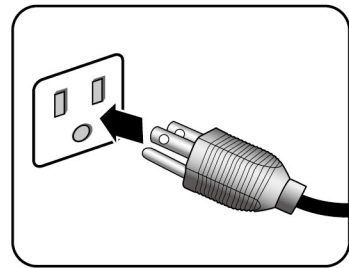

12

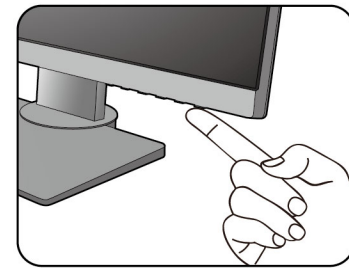

Connecting multiple monitors via MST (Multi-Stream Transport)

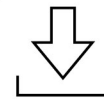
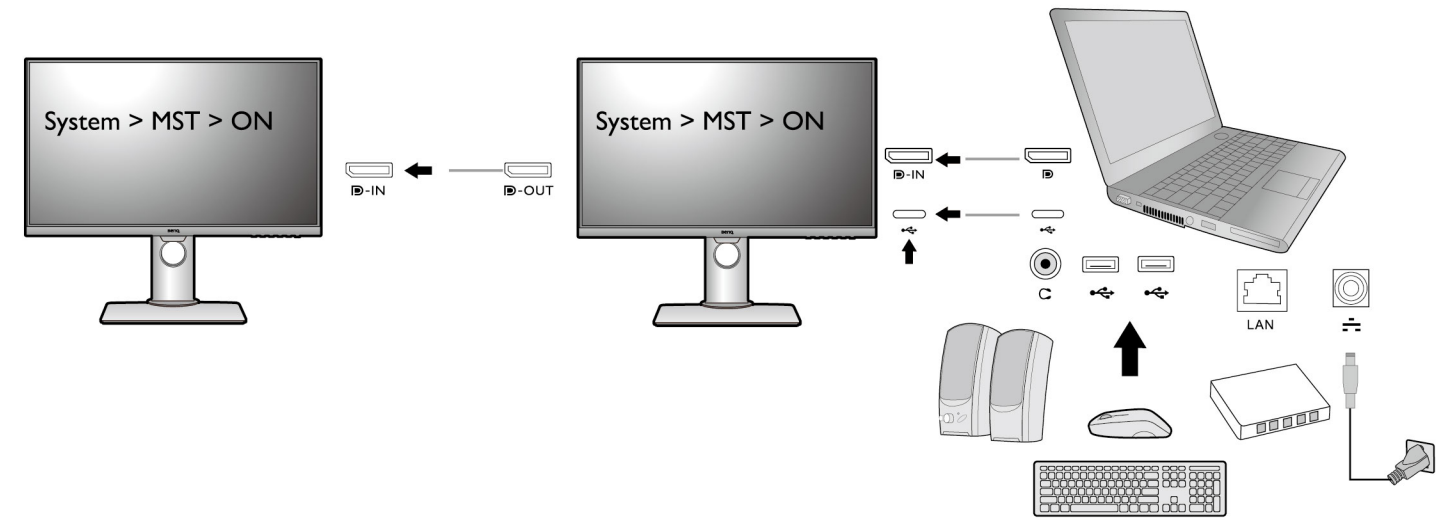

Software installation

Display Pilot: for display arrangement & color matching (ICC Sync)

Support.BenQ.com

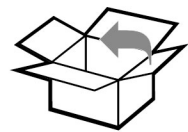
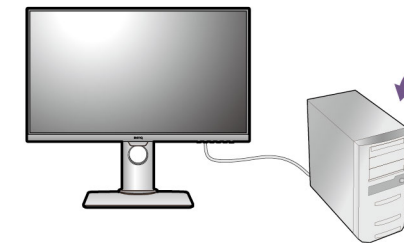

1

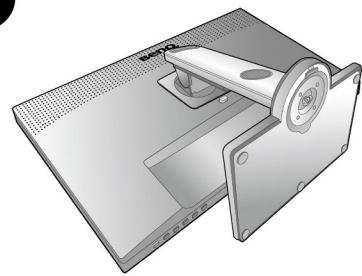

2

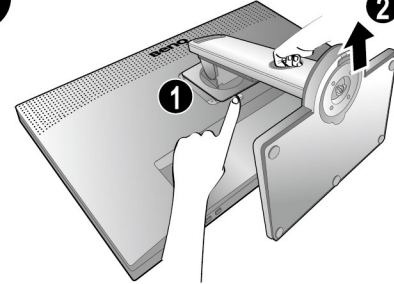

3

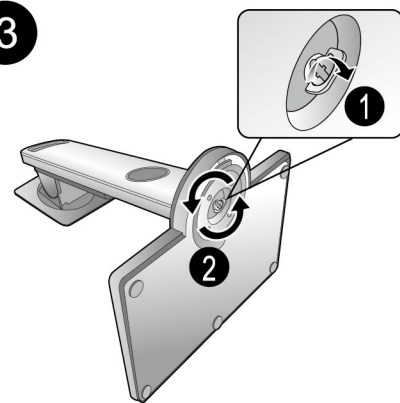

4

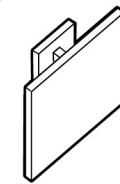
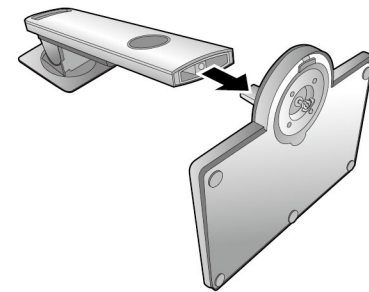

1

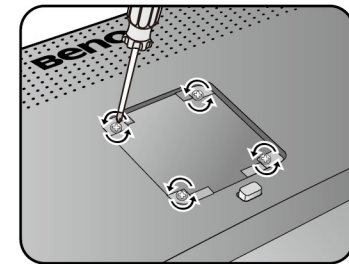

M4 x 10 mm

2

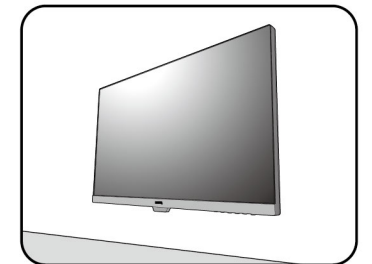

Support.BenQ.com

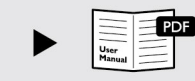

Online Manual



Product Support



Software Download

For professional color display



CAD / CAM Mode



Animation Mode

For work efficiency



DualView



KVM Switch