



Dell S3423DWC

User's Guide

Monitor Model: S3423DWC
Regulatory Model: S3423DWCc



-  **NOTE:** A NOTE indicates important information that helps you make better use of your computer.
-  **CAUTION:** A CAUTION indicates potential damage to hardware or loss of data if instructions are not followed.
-  **WARNING:** A WARNING indicates a potential for property damage, personal injury, or death.

Copyright © 2022 Dell Inc. or its subsidiaries. All rights reserved. Dell, EMC, and other trademarks are trademarks of Dell Inc. or its subsidiaries. Other trademarks may be trademarks of their respective owners.

2022 – 03

Rev. A00



Contents

Safety instructions	6
About your monitor	7
Package contents	7
Product features	9
Identifying parts and controls	11
Front view	11
Back view	12
Side view	13
Bottom view	13
Monitor specifications	15
Resolution specifications	17
Supported video modes	17
Preset display modes	18
Electrical specifications	19
Physical characteristics	20
Environmental characteristics	21
Plug-and-Play capability	22
LCD monitor quality and pixel policy	22
Ergonomics	22
Handling and moving your display	24
Maintenance guidelines	25
Cleaning your monitor	25



- Setting up the monitor 27**
 - Attaching the stand 27
 - Connecting your monitor 28
 - Connecting the USB-C and USB 3.0 cable 28
 - Organizing cables 29
 - Securing your monitor using Kensington lock (optional) 29
 - Removing the stand 30
 - Wall mounting (optional) 31
- Operating your monitor 32**
 - Power on the monitor 32
 - Using the control buttons 32
 - Control buttons 33
 - OSD controls 34
 - Using the On-Screen Display (OSD) menu 35
 - Accessing the OSD menu 35
 - Menu and Power button lock 49
 - OSD warning messages 51
 - Setting the maximum resolution 54
 - Setting the KVM switch. 55
 - Setting the Auto KVM. 56
 - Using the tilt and vertical extension. 57
 - Tilt extension 57
 - Vertical extension 57



Troubleshooting 58

- Self-test 58
- Built-in diagnostics 59
- Common problems 61

Regulatory information 65

- FCC notices (U.S. Only) and other regulatory information 65
- EU product database for energy label and product information sheet 65
- Contacting Dell. 65



Safety instructions

Use the following safety guidelines to protect your monitor from potential damage and to ensure your personal safety. Unless otherwise noted, each procedure included in this document assumes that you have read the safety information that shipped with your monitor.

 **NOTE: Before using the monitor, read the safety information that is shipped with your monitor and printed on the product. Keep the documentation at a secure location for future reference.**

 **WARNING: Use of controls, adjustments, or procedures other than those specified in this documentation may result in exposure to shock, electrical hazards, and/or mechanical hazards.**

 **WARNING: The possible long-term effect of listening to audio at high volume through the headphones (on monitor that support it) may cause damage to your hearing ability.**

- . Place the monitor on a solid surface and handle it carefully. The screen is fragile and can be damaged if dropped or hit with a sharp object.
- . Ensure that your monitor is electrically rated to operate with the AC power available in your location.
- . Keep the monitor in room temperature. Excessive cold or hot conditions can have an adverse effect on the liquid crystal of the display.
- . Connect the power cable from the monitor to a wall outlet that is near and accessible. See [Connecting your monitor](#).
- . Do not place and use the monitor on a wet surface or near water.
- . Do not subject the monitor to severe vibration or high impact conditions. For example, do not place the monitor inside a car trunk.
- . Unplug the monitor when it is going to be left unused for an extended period.
- . To avoid electric shock, do not attempt to remove any cover or touch the inside of the monitor.
- . Read these instructions carefully. Keep this document for future reference. Follow all warnings and instructions marked on product.
- . Certain monitors can be wall mounted using the VESA mount that is sold separately. Ensure to use the correct VESA specifications as mentioned in the wall mounting section of the User's Guide.

For information on safety instructions, see *the Safety, Environmental, and Regulatory Information (SERI)* document that is shipped with your monitor.







About your monitor



Package contents

The following table provides the list of components that are shipped with your monitor. If any component is missing, contact Dell. For more information, see [Contacting Dell](#).

 **NOTE: Some items may be optional and may not ship with your monitor. Some features may not be available in certain countries.**

Component image	Component description
	Monitor
	Stand riser
	Stand base
	Power cable (varies by countries)



Component image	Component description
	<p>Super speed USB 3.2 Gen 2 10 Gbps Type-C to Type-C upstream cable (C-C cable) (1 meter)</p>
	<p>USB 3.0 upstream cable (enables the USB ports on the monitor)</p>
	<ul style="list-style-type: none"> · Quick Setup Guide · Safety, Environmental, and Regulatory Information



Product features

The Dell S3423DWC monitor has an active matrix, Thin-Film Transistor (TFT), Liquid Crystal Display (LCD), anti-static, and LED backlight. The monitor features include:

- . 86.42 cm (34.0 in.) viewable area display (measured diagonally).
- . 3440 x 1440 resolution, with full-screen support for lower resolutions.
- . Compatible with (AMD FreeSync), high refresh rates, and a rapid response time of 4 ms.
- . Supports 48 Hz to 100 Hz (HDMI) and 48 Hz to 100 Hz (USB-C Alternate mode with DisplayPort 1.4) in Freesync Mode.
- . Built-in Speaker (5 W) x 2.
- . Color gamut of 99% sRGB.
- . Supports both Picture by Picture (PBP) / Picture in Picture (PIP) Select Mode.
- . Digital connectivity with USB-C and HDMI.
- . Single USB-C to supply power (PD 65W) to a compatible notebook while receiving video and data signal.
- . Equipped with 1 USB-C upstream port, 1 Type B upstream port, 1 super speed USB 5 Gbps (USB 3.2 Gen 1) Type-A downstream port, and 1 super speed USB 5 Gbps (USB 3.2 Gen 1 with BC1.2) Type-A downstream port.
- . The built-in KVM switch allows you to control up to 2 computers from a single set of keyboard and mouse connected to the monitor.
- . Supports Auto KVM for multiple input setup.
- . Enables user to switch USB KVM function in PBP mode.
- . Plug-and-play capability if supported by your computer.
- . On-Screen Display (OSD) adjustments for ease of setup and screen optimization.
- . Removable stand and Video Electronics Standards Association (VESA) 100 mm mounting holes for flexible mounting solutions.
- . Tilt and height adjustment capabilities.
- . Security-lock slot.
- . ≤ 0.3 W in the Standby Mode
- . Dell Display Manager Software included.
- . Uses Low Blue Light panel and is compliant with TUV Rheinland (Hardware Solution) at factory reset/default setting model (Preset mode: Standard).
- . Optimize eye comfort with a flicker-free screen.



 **WARNING:** The possible long-term effects of blue light emission from the monitor may cause damage to the eyes, which includes but is not limited to eye fatigue and digital eye strain. ComfortView Plus feature is designed to reduce the amount of blue light emitted from the monitor to optimize eye comfort.



Identifying parts and controls

Front view

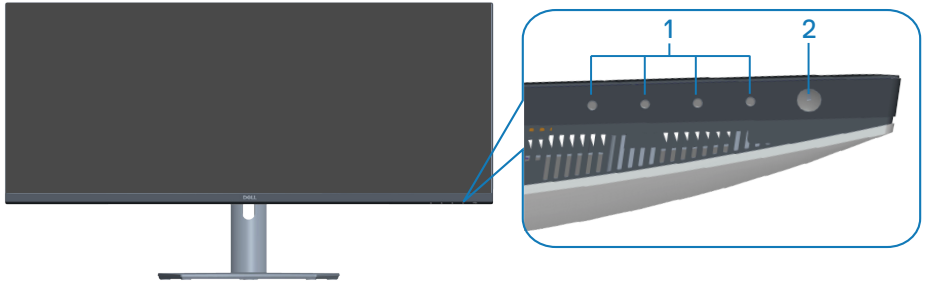

Control buttons

Label	Description	Use
1	Function buttons	To adjust items in the OSD menu. (For more information, see Using the control buttons.)
2	Power On/Off button	To turn the monitor on or off. Solid white light indicates that the monitor is turned on and functioning normally. Blinking white light indicates that the monitor is in Standby Mode.



Back view

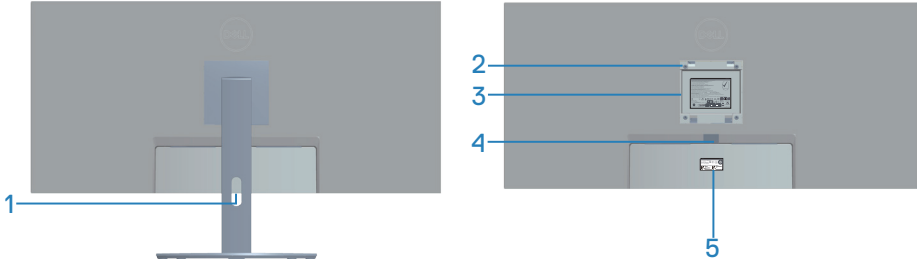

Back View with monitor stand

Label	Description	Use
1	Cable management slot	Used to organize cables by routing them through the slot.
2	VESA mounting holes (100 mm x 100 mm), located behind the VESA cover	Used for wall-mounting the monitor through a VESA-compatible wall-mount kit.
3	Regulatory information label	Lists the regulatory approvals.
4	Stand release button	Releases the stand from the monitor.
5	Regulatory label (including Barcode serial number and Service Tag label)	Lists the regulatory approvals. Refer to this label if you need to contact Dell for technical support. The Service Tag is a unique alphanumeric identifier that enables Dell service technicians to identify the hardware components in your computer and access warranty information.



Side view



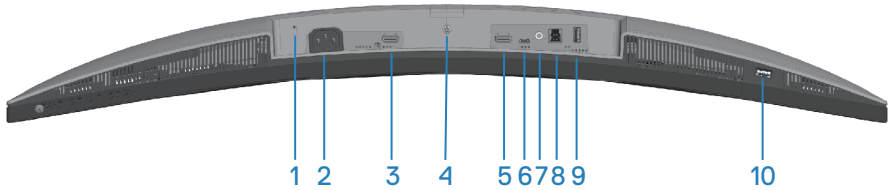

Bottom view



Bottom view without monitor stand

Label	Description	Use
1	Security-lock slot (based on Kensington Security Slot)	Secure your monitor using a security lock (purchased separately) to prevent unauthorized movement of your monitor.
2	Power connector	Connect the power cable (shipped with your monitor).
3	HDMI 1 2.0 port	Connect to your computer using an HDMI cable.
4	Stand lock feature	Lock the stand to the monitor using a M3 x 6 mm screw (screw not included).
5	HDMI 2 2.0 port	Connect to your computer using an HDMI cable.



6	USB-C upstream port	<p>Connect the USB-C cable that came with your monitor to the computer or mobile device. This port supports USB Power Delivery, Data, and DisplayPort video signal. The super speed USB 5 Gbps (USB 3.2 Gen 1) Type-C port offers the fastest transfer rate and the alternate mode with DP 1.4 supports a maximum resolution of 3440 x 1440 at 100 Hz, PD 20 V/3.25 A, 15 V/3 A, 9 V/3 A, 5 V/3 A.</p> <p> NOTE: USB-C is not supported on Windows versions that were released before Windows 10.</p>
7	Audio line out port	<p>Connect to an external speaker or a sub-woofer (purchased separately).*</p>
8	Super speed USB 5 Gbps (USB 3.2 Gen 1) Type-B upstream port	<p>Connect the USB cable that came with your monitor to the computer. Once this cable is connected, you can use the USB connectors on the monitor.</p>
9	Super speed USB 5 Gbps (USB 3.2 Gen 1) Type-A downstream port (3)	<p>Connect your USB device.**</p> <p> NOTE: To use this port, you must connect the USB-C cable or USB Upstream Cable (shipped with your monitor) to the USB-C upstream port or the USB Type-B upstream port on the monitor and to your computer.</p>
10	Super speed USB 5 Gbps (USB 3.2 Gen 1) Type-A downstream port with Power Charging	<p>Connect your USB device** or charge your device</p> <p> NOTE: To use this port, you must connect the USB-C cable or USB Upstream Cable (shipped with your monitor) to the USB-C upstream port or the USB Type-B upstream port on the monitor and to your computer.</p>

*Audio line out port does not support headphones.

**To avoid signal interference, when a wireless USB device has been connected to a USB downstream port, it is NOT recommended to connect any other USB devices to the adjacent port(s).



Monitor specifications

Model	S3423DWC
Screen type	Active matrix-TFT LCD
Panel type	Vertical Alignment
Viewable image	
Diagonal	864.2 mm (34.0 in.)
Horizontal, Active Area	797.2 mm (31.19 in.)
Vertical, Active Area	333.7 mm (13.14 in.)
Area	266048.26 mm ² (412.38 in. ²)
Native resolution and refresh rate	3440 x 1440 at 100 Hz (HDMI 1 and HDMI 2) 3440 x 1440 at 100 Hz (USB-C)
Pixel pitch	0.2318 mm x 0.2318 mm
Pixel per inch (PPI)	109
Viewing angle	
Horizontal	178° (typical)
Vertical	178° (typical)
Luminance output	350 cd/m ² (typical)
Contrast ratio	3000 to 1 (typical)
Faceplate coating	Anti-glare with 3H hardness
Backlight	LED edgelight system
Response time (Gray to Gray)	4 ms (Extreme mode) 5 ms (Fast mode) 8 ms (Normal mode)
Color depth	16.7 million colors
Color gamut	sRGB CIE 1931 (99%)



Connectivity	<p>2 x HDMI 2.0 with HDCP 2.2</p> <p>1 x USB Type -C upstream (Alternate mode with DisplayPort 1.4, Power Delivery PD up to 65 W)*</p> <p>1 x super speed USB 5 Gbps (USB 3.2 Gen 1) Type-B upstream port</p> <p>1 x super speed USB 5 Gbps (USB 3.2 Gen 1) downstream port</p> <p>1 x super speed USB 5 Gbps (USB 3.2 Gen 1) with BC1.2 charging capability at 2 A (maximum)</p> <p>1 x Audio line out</p>
Bezel width (edge of monitor to active area)	
Top	8.64 mm
Left/Right	8.65 mm
Bottom	22.14 mm
Adjustability	
Height adjustable stand	100 mm
Tilt	-5° to 21°
Swivel	N/A
Slant Adjust	-4° to 4°
Dell display manager compatibility	Easy Arrange and other key features
Security	Security-lock slot (cable lock optional purchase)

*USB-C (Alternate mode with DisplayPort 1.4): HBR3/DisplayPort 1.4/DP audio is supported.



Resolution specifications

Model	S3423DWC
Horizontal scan range	30 kHz to 160 kHz
Vertical scan range	48 Hz to 100 Hz (HDMI) 48 Hz to 100 Hz (USB-C)
Maximum preset resolution	3440 x 1440 at 100 Hz (USB-C) 3440 x 1440 at 100 Hz (HDMI)

Supported video modes

Model	S3423DWC
Video display capabilities (HDMI/USB-C)	480p, 480i(HDMI), 576p, 720p, 1080p, 576i(HDMI), 1080i(HDMI)



Preset display modes

Display Mode	Horizontal Frequency (kHz)	Vertical Frequency (Hz)	Pixel Clock (MHz)	Sync Polarity (Horizontal / Vertical)
VESA, 640 x 480	31.47	59.94	25.18	-/-
VESA, 640 x 480	37.50	75	31.50	-/-
IBM, 720 x 400	31.47	70.08	28.32	-/+
VESA, 800 x 600	37.88	60.32	40	+/+
VESA, 800 x 600	46.88	75	49.50	+/+
VESA, 1024 x 768	48.36	60	65	-/-
VESA, 1024 x 768	60.02	75.03	78.75	+/+
VESA, 1152 x 864	67.50	75	108	+/+
VESA, 1280 x 1024	63.98	60.02	108	+/+
VESA, 1280 x 1024	79.98	75.02	135	+/+
VESA, 1600 x 900	60	60	108	+/+
VESA, 1600 x 1200	75	60	162	+/+
VESA, 1680 x 1050	65.29	59.95	146.25	-/+
VESA, 1920 x 1080	67.50	60	148.50	+/+
VESA, 1920 x 1080	113.22	100	235.50	+/-
VESA, 1920 x 1200	74.04	59.95	154	+/-
VESA, 2560 x 1080	66.66	60	185.58	+/-
VESA, 2560 x 1080	113.24	100	308	+/-
VESA, 3440 x 1440	49.99	73.68	265.25	+/-
VESA, 3440 x 1440	88.82	59.97	319.75	+/-
VESA, 3440 x 1440	150.97	99.98	543.50	+/-

 **NOTE: This monitor supports AMD FreeSync.**



Electrical specifications

Model	S3423DWC
Video input signals	HDMI 2.0 (HDCP), 600 mV for each differential line, 100 ohm input impedance per differential pair USB-C 1.4, 600 mV for each differential line, 100 ohm input impedance per differential pair
AC input voltage/frequency/current	100 VAC to 240 VAC / 50 Hz or 60 Hz \pm 3 Hz / 2.0A (max.)
Inrush current	120 V: 30 A (max.) at 0°C (cold start) 240 V: 60 A (max.) at 0°C (cold start)
Power Consumption	0.3 W (Off Mode) ¹ 0.4 W (Standby Mode) ¹ 31 W (On Mode) ¹ 160 W (max) ² 32 W (Pon) ³ 100.96 kWh (TEC) ³

¹ As defined in EU 2019/2021 and EU 2019/2013.

² Max brightness and contrast setting with maximum power loading on all USB ports.

³ Pon: Power consumption of On Mode measured with reference to Energy Star test method.

TEC: Total energy consumption in kWh measured with reference to Energy Star test method.

This document is informational only and reflects laboratory performance. Your product may perform differently, depending on the software, components and peripherals you ordered and shall have no obligation to update such information. Accordingly, the customer should not rely upon this information in making decisions about electrical tolerances or otherwise. No warranty as to accuracy or completeness is expressed or implied.



Physical characteristics

Model	S3423DWC
Signal cable type	<ul style="list-style-type: none">. Digital: USB-C, 24 pins. Universal Serial Bus: USB, 9 pins
Dimensions (with stand)	
Height (extended)	489.36 mm (19.27 in.)
Height (compressed)	389.36 mm (15.33 in.)
Width	808.16 mm (31.82 in.)
Depth	217.05 mm (8.55 in.)
Dimensions (without stand)	
Height	364.50 mm (14.35 in.)
Width	808.16 mm (31.82 in.)
Depth	64.03 mm (2.52 in.)
Stand dimensions	
Height	382.20 mm (15.05 in.)
Width	302 mm (11.89 in.)
Depth	217.05 mm (8.55 in.)
Weight	
Weight with packaging	15.21 kg (33.53 lb)
Weight with stand assembly and cables	10.53 kg (23.21 lb)
Weight without stand assembly (no cables)	6.65 kg (14.66 lb)
Weight of stand assembly	3.09 kg (6.81 lb)
Front-frame gloss	Black frame 2-4 gloss units



Environmental characteristics

Model	S3423DWC
Compliant Standards	
<ul style="list-style-type: none"> . RoHS-compliant . BFR/PVC reduce monitor (The circuit boards are made from BFR/PVC-free laminates) . Arsenic-free glass and Mercury-free for the panel only . Energy Gauge shows the energy level being consumed by the monitor in real time. 	
Temperature	
Operating	0°C to 40°C (32°F to 104°F)
Non-operating	<ul style="list-style-type: none"> . Storage: -20°C to 60°C (-4°F to 140°F) . Shipping: -20°C to 60°C (-4°F to 140°F)
Humidity	
Operating	10% to 80% (non-condensing)
Non-operating	<ul style="list-style-type: none"> . Storage 10% to 90% (non-condensing) . Shipping 10% to 90% (non-condensing)
Altitude	
Operating (maximum)	5,000 m (16,400 ft)
Non-operating (maximum)	12,192 m (40,000 ft)
Thermal dissipation	<ul style="list-style-type: none"> . 109.22 BTU/hour (typical) . 546.07 BTU/hour (maximum)



Plug-and-Play capability

You can install the monitor in any Plug-and-Play compatible computer. The monitor automatically provides the computer with its Extended Display Identification Data (EDID) using Display Data Channel (DDC) protocols so the system can configure itself and optimize the monitor settings. Most monitor installations are automatic. You can select different settings, if necessary. For more information about changing the monitor settings, see [Operating your monitor](#).

LCD monitor quality and pixel policy

During the LCD Monitor manufacturing process, it is not uncommon for one or more pixels to become fixed in an unchanging state, which are hard to see and do not affect the display quality or usability. For more information on Dell Monitor Quality and Pixel Policy, see Dell Support site at www.dell.com/pixelguidelines.

Ergonomics

 **CAUTION: Improper or prolonged usage of keyboard may result in injury.**

 **CAUTION: Viewing the monitor screen for extended periods of time may result in eye strain.**

For comfort and efficiency, observe the following guidelines when setting up and using your computer workstation:

- . Position your computer so that the monitor and keyboard are directly in front of you as you work. Special shelves are commercially available to help you correctly position your keyboard.
- . To reduce the risk of eye strain and neck, arm, back, or shoulder pain from using the monitor for long period, we recommend you to:
 1. Set the distance of the screen between 20 in. to 28 in. (50 cm - 70 cm) from your eyes.
 2. Blink frequently to moisten your eyes or wet your eyes with water after prolonged usage of the monitor.
 3. Take regular and frequent breaks for 20 minutes every two hours.
 4. Look away from your monitor and gaze at a distant object at 20 feet away for at least 20 seconds during the breaks.
 5. Perform stretches to relieve tension in the neck, arm, back, and shoulders during the breaks.



- Ensure that the monitor screen is at eye level or slightly lower when you are sitting in front of the monitor.
- Adjust the tilt of the monitor, its contrast, and brightness settings.
- Adjust the ambient lighting around you (such as overhead lights, desk lamps, and the curtains or blinds on nearby windows) to minimize reflections and glare on the monitor screen.
- Use a chair that provides good lower-back support.
- Keep your forearms horizontal with your wrists in a neutral, comfortable position while using the keyboard or mouse.
- Always leave space to rest your hands while using the keyboard or mouse.
- Let your upper arms rest naturally on both sides.
- Ensure that your feet are resting flat on the floor.
- When sitting, ensure that the weight of your legs is on your feet and not on the front portion of your seat. Adjust your chair's height or use a footrest if necessary to maintain a proper posture.
- Vary your work activities. Try to organize your work so that you do not have to sit and work for extended periods of time. Try to stand or get up and walk around at regular intervals.
- Keep the area under your desk clear of obstructions and cables or power cords that may interfere with comfortable seating or present a potential trip hazard.

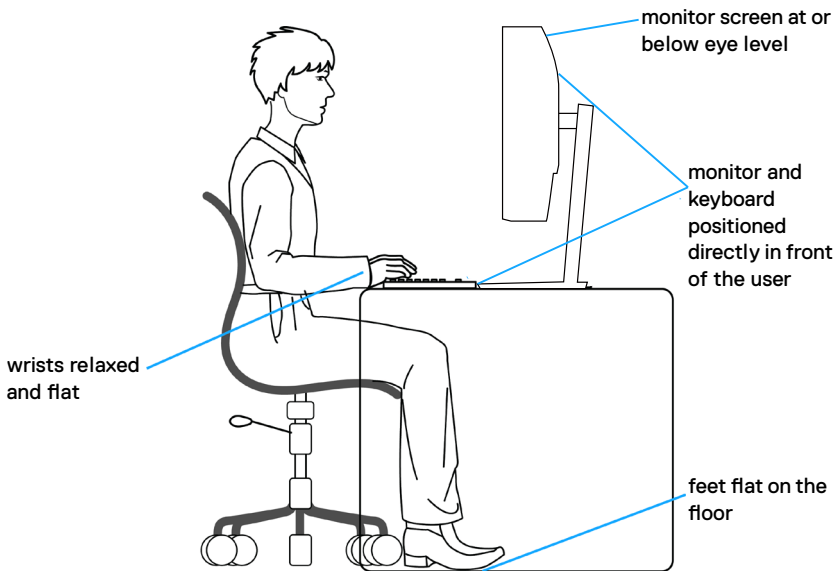

Handling and moving your display

To ensure that the monitor is handled safely when lifting or moving it, observe the following guidelines:

- . Before moving or lifting the monitor, turn off your computer and the monitor.
- . Disconnect all cables from the monitor.
- . Place the monitor in the original box with the original packing materials.
- . Hold the bottom edge and the side of the monitor firmly without applying excessive pressure when lifting or moving the monitor.

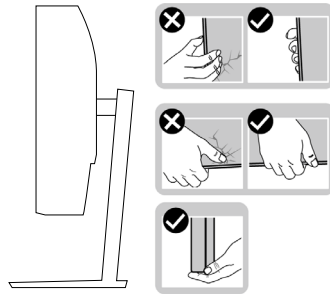

- . When lifting or moving the monitor, ensure that the screen is facing away from you. Do not press on the display area to avoid any scratches or damage.

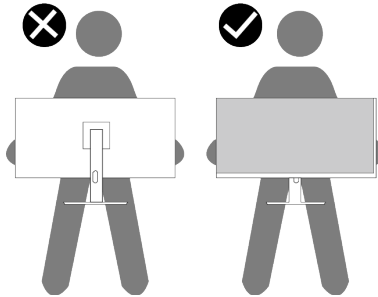

- . When transporting the monitor, avoid any sudden shock or vibration to it.
- . When lifting or moving the monitor, do not turn the monitor upside down while holding the stand base or stand riser. It may result in accidental damage to the monitor or cause personal injury.



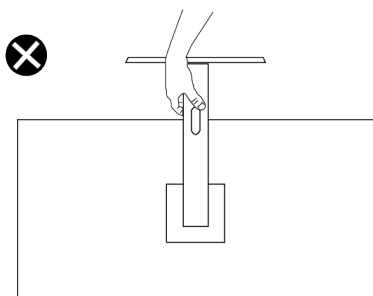

Maintenance guidelines

Cleaning your monitor

- ⚠ **WARNING:** Using improper methods when cleaning the monitor can result in a physical damage to the screen or the body of your Dell monitor.
- ⚠ **CAUTION:** Read and follow the [Safety instructions](#) before cleaning the monitor.
- ⚠ **WARNING:** Before cleaning the monitor, unplug the monitor power cable from the electrical outlet.

For best practices, follow the instructions in the list below when unpacking, cleaning, or handling your monitor:

- To clean the Dell monitor screen, lightly dampen a soft, clean cloth with water. If possible, use a special screen-cleaning tissue or solution suitable for the Dell monitor screen.
- ⚠ **CAUTION:** Do not use detergents or other chemicals such as benzene, thinner, ammonia, abrasive cleaners, or compressed air.
- ⚠ **CAUTION:** Using chemicals for cleaning may cause changes in the appearance of the monitor, such as color fading, milky film on the monitor, deformation, uneven dark shade, and peeling of screen area.
- ⚠ **WARNING:** Do not spray the cleaning solution or even water directly on the surface of the monitor. Doing so will allow liquids to accumulate at the bottom of the display panel and corrode the electronics resulting in permanent damage. Instead, apply the cleaning solution or water to a soft cloth and then clean the monitor.





 **NOTE: Monitor damage due to improper cleaning methods and the use of benzene, thinner, ammonia, abrasive cleaners, alcohol, compressed air, detergent of any kind will lead to a Customer Induced Damage (CID). CID is not covered under the standard Dell warranty.**

- If you notice white powder when you unpack your monitor, wipe it off with a cloth.
- Handle your monitor with care as a dark-colored monitor may get scratched and show white scuff marks more than a light-colored monitor.
- To help maintain the best image quality on your monitor, use a dynamically changing screen saver and turn off your monitor when not in use.



Setting up the monitor

Attaching the stand

-  **NOTE:** The stand is not installed at the factory when shipped.
-  **NOTE:** The following instructions are applicable only for the stand that was shipped with your monitor. If you are attaching a stand that you purchased from any other source, follow the setup instructions that were included with the stand.

To attach the monitor stand:

1. Follow the instructions on the flaps of carton to remove the stand from the top cushion that secures it.
2. Connect the stand base to the stand riser.
3. Open the screw handle on the stand base and tighten the screw to secure the stand riser to the stand base.
4. Close the screw handle.

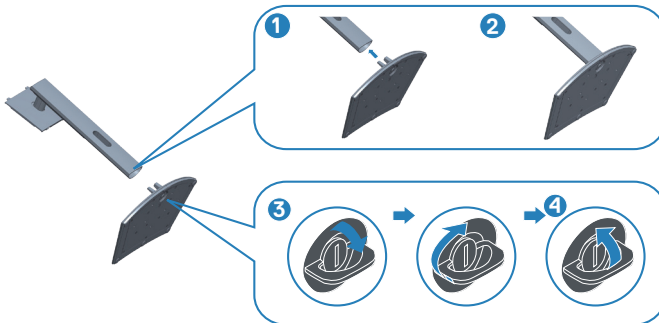



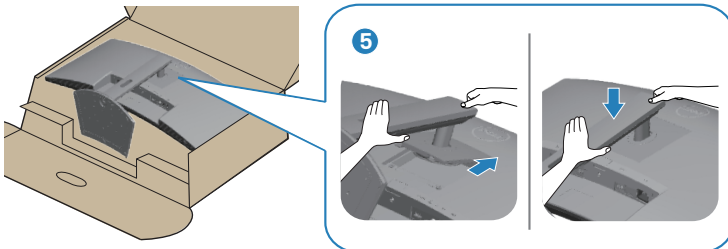

5. Slide the tabs on the stand assembly into the slots on the monitor and press the stand assembly down to snap it into place.



6. Place the monitor upright.



Connecting your monitor

-  **WARNING:** Before you begin any of the procedures in this section, follow the [Safety instructions](#).
-  **NOTE:** Dell monitors are designed to work optimally with Dell-supplied inbox cables. Dell does not guarantee the video quality and performance if non-Dell cables are used.
-  **NOTE:** Route the cables through the cable-management slot before connecting them.
-  **NOTE:** Do not connect all cables to the computer at the same time.
-  **NOTE:** The images are for the purpose of illustration only. The appearance of the computer may vary.

To connect your monitor to the computer:

1. Turn off your computer and disconnect the power cable.
2. Connect the HDMI or USB-C cable (optional purchase) from your monitor to the computer.
3. Connect the USB upstream cable (shipped with your monitor) to an appropriate USB 3.0 port on your computer. (See [Bottom view](#) for details.)
4. Connect the USB 3.0 peripherals to the downstream USB 3.0 ports on the monitor.

Connecting the USB-C and USB 3.0 cable

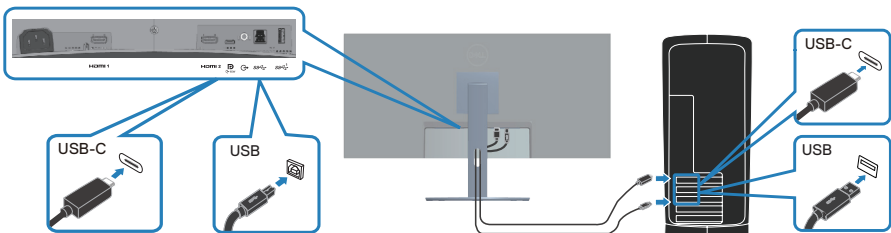

5. Connect the power cables from your computer and monitor into a wall outlet.



Organizing cables

Use the cable-management slot to route the cables connected to your monitor.

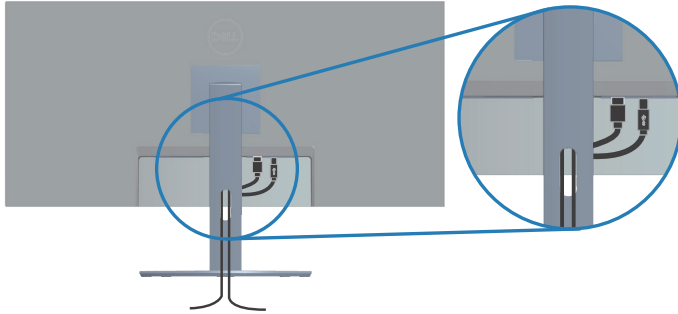

Securing your monitor using Kensington lock (optional)

The security-lock slot is located at the bottom of the monitor. (See [Security-lock slot](#)). Secure your monitor to a table using the Kensington security-lock.

For more information on using the Kensington lock (sold separately), see the documentation that is shipped with the lock.

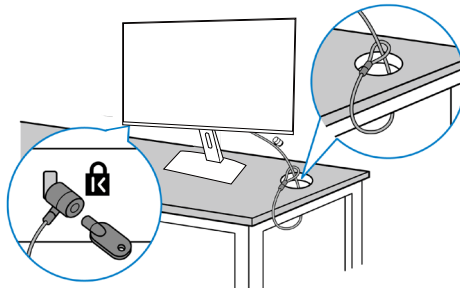

NOTE: The image is for the purpose of illustration only. The appearance of the lock may vary.



Removing the stand

 **NOTE:** To prevent scratches on the LCD screen when removing the stand, ensure that the monitor is placed on a soft surface and handle it carefully.

 **NOTE:** The following steps are specifically for removing the stand that is shipped with your monitor. If you are removing a stand that you purchased from any other source, follow the setup instructions that are included with the stand.

To remove the stand:

1. Place the monitor on a soft cloth or cushion at the edge of the desk.

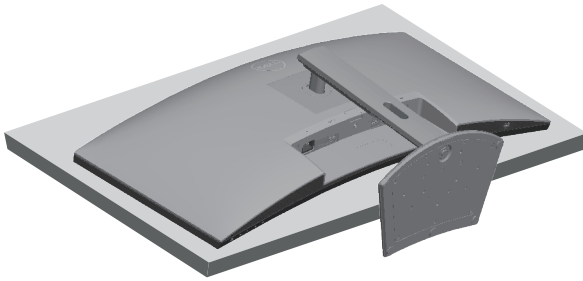

2. Press and hold the stand release button, and then lift the stand off the monitor.

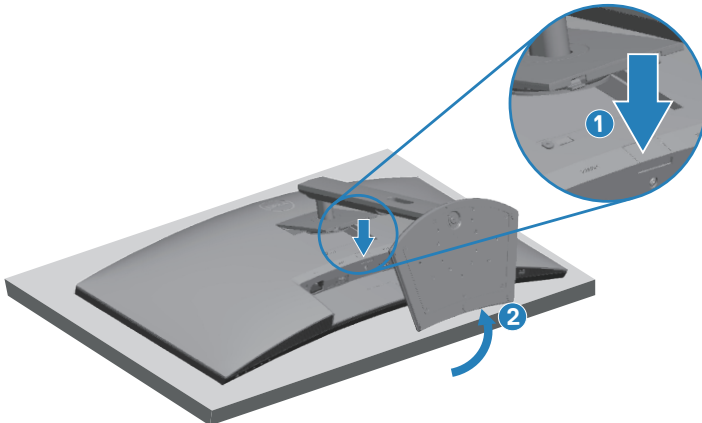

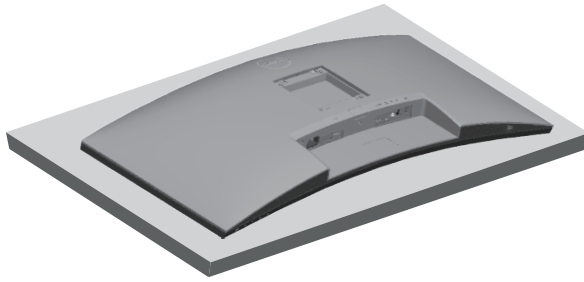

Wall mounting (optional)

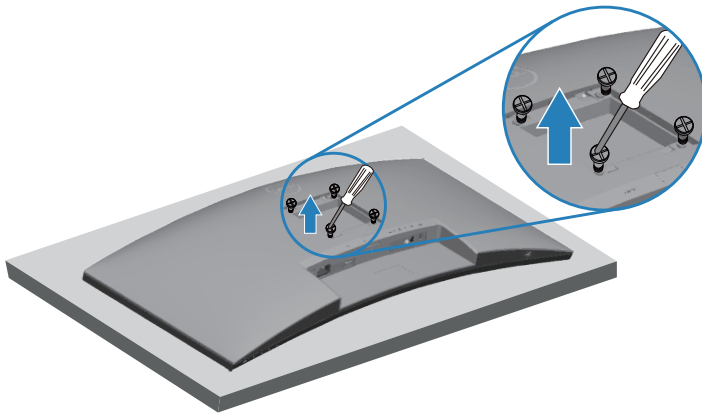

(Screw dimension: M4 x 10 mm).

See the documentation that is shipped with the VESA-compatible wall-mounting kit.

1. Lay the monitor on a soft cloth or cushion at the edge of the desk.
2. Remove the stand. See [Removing the stand](#) for details.
3. Remove the four screws that secure the panel to the monitor.
4. Attach the mounting bracket from the wall mounting kit to the monitor.
5. To mount the monitor on the wall, see the documentation that is shipped with the wall-mounting kit.

 **NOTE: For use only with UL or CSA or GS-listed wall mount bracket with minimum weight/load-bearing capacity of 26.6 kg.**



Operating your monitor

Power on the monitor

Press the  button to turn on the monitor.

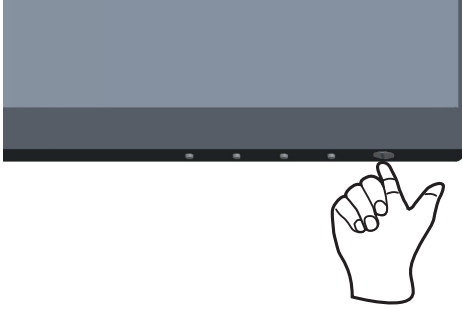



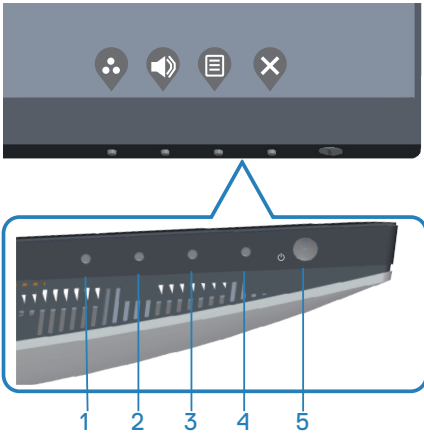

Using the control buttons

Use the control buttons at the bottom edge of the monitor to adjust the image being displayed.



Control buttons

The following table describes the control buttons:





Control Buttons	Description
1  Shortcut key/Preset Modes	Use this button for choose from a list of preset modes.
2  Shortcut key/Input Source	Use the button to adjust the volume. Minimum is '0' (-). Maximum is '100' (+).
3  Menu	Use the Menu button at launch your on-screen display (OSD) and select the OSD menu. See Accessing the OSD menu .
4  Exit	Use the button to go back to the main menu or exit the OSD main menu.
5  Power On/Off button (with LED indicator)	Use the power button to turn the monitor on or off. Solid white light indicates the monitor is turned on. Blinking white light indicates it is in Standby mode.

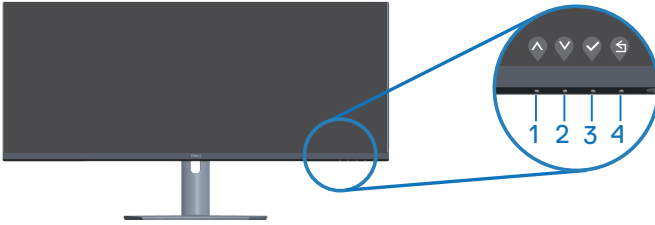

OSD controls

Use the buttons on the bottom of the monitor to adjust the image settings.





	Control Buttons	Description
1	 Up	Use the Up button to increase values or move up in a menu.
2	 Down	Use the Down button to decrease values or move down in a menu.
3	 OK	Use the OK button to confirm your selection in a menu.
4	 Back	Use the Back button to go back to the previous menu.











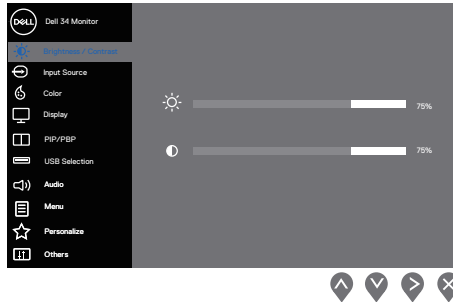



Using the On-Screen Display (OSD) menu

Accessing the OSD menu

 **NOTE:** Any changes you make are automatically saved when you move to another menu, exit the OSD menu, or wait for the OSD menu to automatically close.

1. Press the  button to display the OSD main menu.



2. Press the  and  buttons to move between the setting options. As you move from one icon to another, the option is highlighted.
3. Press the  or  or  button once to activate the highlighted option.
4. Press the  and  buttons to select the desired parameter.
5. Press the  button and then use the  and  buttons, according to the indicators on the menu, to make your changes.
6. Select the  button to return to previous menu or the  button to accept or return to previous menu.



Icon	Menu and Submenus	Description
------	-------------------	-------------



**Brightness/
Contrast**

Uses this menu to adjust the brightness and contrast.

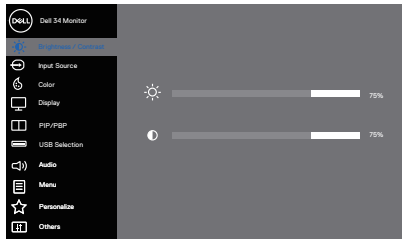

Brightness Adjusts the brightness of the backlight.
 Presses the button to increase the brightness and presses the button to decrease the brightness (min. 0/ max. 100).

Contrast Adjusts the brightness first, and then adjusts the contrast only if further adjustment is necessary.
 Presses the button to increase the contrast and presses the button to decrease the contrast (min. 0/max. 100).
 The Contrast function adjusts the degree of difference between darkness and lightness on the monitor screen.



Icon	Menu and Submenus	Description
------	-------------------	-------------



Input Source

Uses the input source menu to select between the different video signals that may be connected to your monitor.

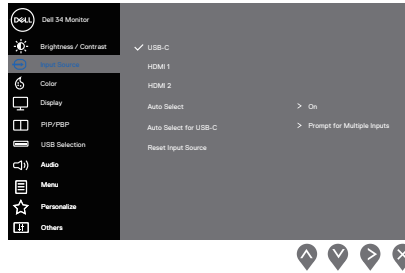

USB-C

Selects the **USB-C** input when you are using the USB-C connector. Presses the  button to select the **USB-C** input source.

HDMI 1

Selects **HDMI 1** input when you are using the HDMI 1 connector. Presses the  button to select the **HDMI 1** input source.

HDMI 2

Selects **HDMI 2** input when you are using the HDMI 2 connector. Presses the  button to select the **HDMI 2** input source.

Auto Select

Selects **Auto Select** to scan for available input signals.

Auto Select for USB-C

Selects **Auto Select for USB-C** to view the following options:

- **Prompt for Multiple Inputs:** Always displays the **Switch to USB-C Video Input** message for you to choose whether to switch or not.
- **Yes:** Always switches to USB-C video input (without asking) when the USB-C cable is connected.
- **No:** Never automatically switches to USB-C video input when the USB-C cable is connected.

 **NOTE: Auto Select for USB-C** is available only when **Auto Select** is on

Reset Input Source

Selects this option to restore default **Input Source**.



Icon	Menu and Submenus	Description
------	-------------------	-------------



Color

Changes the **color** setting mode.

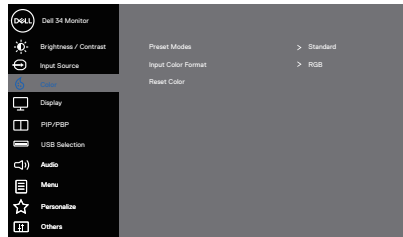

Preset Modes

When you select **Preset Modes**, you can choose **Standard, Movie, FPS, RTS, RPG, Warm, Cool,** or **Custom color** from the list.



- **Standard:** Loads the monitor's default color settings. This is the default preset mode.
- **Movie:** Loads color settings ideal for movies.
- **FPS:** Loads color settings ideal for First-person Shooter games.
- **RTS:** Loads color settings ideal for Real-time Strategy games.
- **RPG:** Loads color settings ideal for Role-playing games.
- **Warm:** Increases the color temperature. The screen appears warmer with a red/yellow tint.
- **Cool:** Decreases the color temperature. The screen appears cooler with a blue tint.
- **Custom Color:** Allows you to manually adjust the color settings.



Icon	Menu and Submenus	Description
------	-------------------	-------------



Preset Modes

Presses the  and  buttons to adjust the three colors (R, G, B) values and create your own preset color mode.

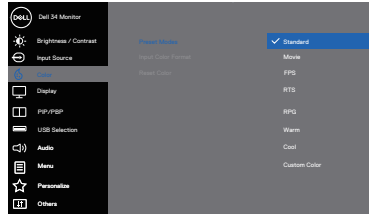







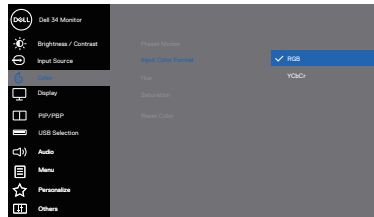



Input Color Format

Allows you to set the video input mode to:

- **RGB:** Selects this option if your monitor is connected to a computer or a media player that supports RGB output.
- **YCbCr:** Selects this option if your media player supports only YCbCr output.



Icon	Menu and Submenus	Description
	Hue	<p>Uses this feature to adjust the flesh tone color in the video image. Press the  or  button to adjust the hue from 0 to 100.</p> <p>Presses the  button to increase the green shade of the video image.</p> <p>Presses the  button to increase the purple shade of the video image.</p> <p> NOTE: Hue adjustment is available only when you select Movie and Game mode.</p>
	Saturation	<p>Adjusts the color saturation of the video image. Uses the  or  button to adjust the saturation from 0 to 100.</p> <p>Presses the  button to increase the monochrome appearance of the video image.</p> <p>Presses the  button to increase the colorful appearance of the video image.</p> <p> NOTE: Saturation adjustment is available only when you select Movie and Game mode.</p>
	Reset Color	Resets your monitor's color settings to the factory settings.



Icon	Menu and Submenus	Description
------	-------------------	-------------



Display

Uses **Display** to adjust image.

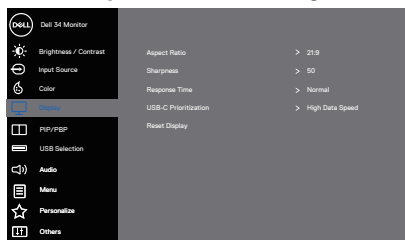

Aspect Ratio Adjusts the image ratio to **21:9** or **Auto Resize** or **4:3** or **1:1**

Sharpness Makes the image look sharper or softer. Presses the or button to adjust the sharpness from 0 to 100.

Response Time Select the response time: **Normal**, **Fast**, or **Extreme**.

USB-C Prioritization Allows you to specify the priority to transfer the data with high resolution (**High Resolution**) or high speed (**High Data Speed**) when using the USB-C port/USB-C.

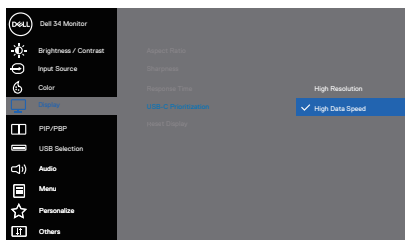

Reset Display Selects this option to restore default display settings.



Icon	Menu and Submenus	Description
------	-------------------	-------------



PIP/PBP

Allows you to watch more images at the same time.

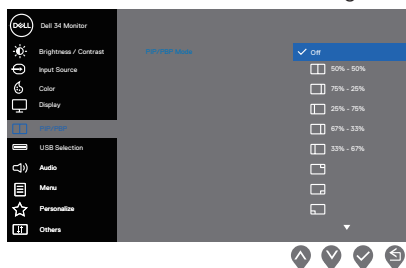

PIP/PBP Mode

Adjusts the **PIP/PBP Mode**. You can adjust this feature by selecting **Off, 50%-50%, 75%-25%, 25%-75%, 67%-33%, 33%-67%, PIP(Small), PIP(Large)**.

NOTE: FreeSync is turned off when PIP/PBP is enabled.

PIP/PBP (Sub)

Selects between **USB-C, HDMI 1** or **HDMI 2** video signal that may be connected to your monitor for the **PIP/PBP** sub-window.

Main Window	Sub-Window		
	USB-C	HDMI 1	HDMI 2
USB-C	—	✓	✓
HDMI 1	✓	—	✓
HDMI 2	✓	✓	—

USB Select Switch

Selects to switch between the USB sources in **PIP/PBP Mode**.

NOTE: This option is available only when PIP/PBP Mode is on.

Audio

Allows you to set the Audio Main or Sub.

Video Swap

Selects to swap videos between main window and sub-window in **PIP/PBP Mode**.

Contrast (Sub)

Adjusts the contrast level of the picture in **PIP/PBP Mode**.

NOTE: Only applicable when the user turns on PIP/PBP.



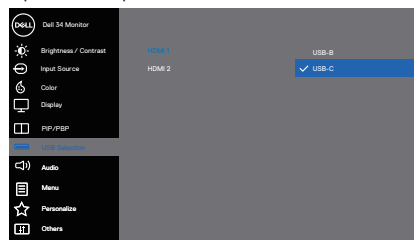

Icon	Menu and Submenus	Description
------	-------------------	-------------

	USB Selection	<p>Allows you to assign the USB upstream port for the input signals (HDMI 1 and HDMI 2), so that the monitor's USB downstream port (for example, keyboard and mouse) can be used by the current input signals when you connect a computer to either one of the upstream ports. See also Setting the KVM switch for details.</p> <p>When you use only one upstream port, the connected upstream port is active.</p>
---	----------------------	--





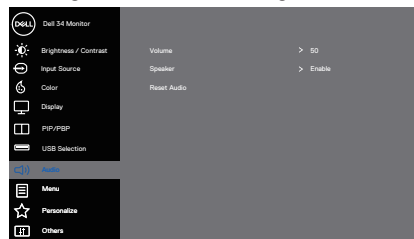

 **NOTE: To prevent data damage or loss, before changing USB upstream ports, make sure that NO USB storage devices are in use by the computer connected to the monitor's USB downstream port.**

Icon	Menu and Submenus	Description
------	-------------------	-------------

	Audio	<p>Change the audio settings.</p>  
---	--------------	--

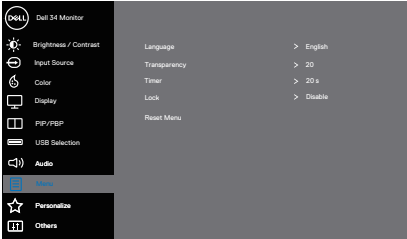
- Volume** Presses the buttons to adjust the volume. Minimum is '0' (-). Maximum is '100' (+).
- Speaker** Selects this option to activate the speaker.
- Reset Audio** Selects this option to restore default display settings.



Icon	Menu and Submenus	Description
	Menu	<p>Selects this option to adjust the settings of the OSD, such as the languages of the OSD, the amount of time the menu remains on screen, and so on.</p> 
	Language	<p>Set the language option for the OSD display: English, Spanish, French, German, Brazilian Portuguese, Russian, Simplified Chinese, or Japanese.</p>
	Transparency	<p>Presses the  or  button to change the menu transparency (0 to 100).</p>
	Timer	<p>OSD hold time: sets the length of time the OSD will remain active after the last time you pressed a button.</p> <p>Presses the  or  button to adjust the slider in 1 second increments, from 5 to 60 seconds.</p>
	Lock	<p>Controls user access to adjustments. User can select one of the following: Menu Buttons, Power Button, Menu + Power Buttons, Disable.</p>
	Reset Menu	<p>Resets all OSD settings to the factory preset values.</p>



Icon

Menu and Submenus

Description



Personalize

Selects this option to adjust the settings of the personalization.

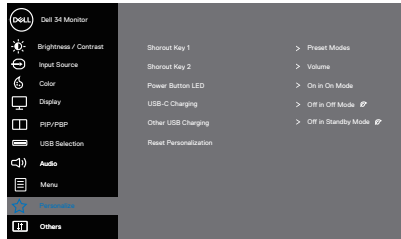

Shortcut Key 1



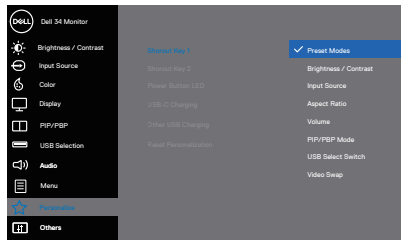

Selects one of the following: **Preset Modes, Brightness/Contrast, Input Source, Aspect Ratio, Volume, PIP/PBP Mode, USB Select Switch, Video Swap** to set the **Shortcut key 1**.

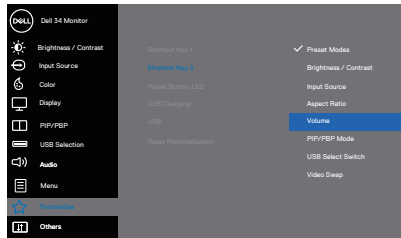

Shortcut Key 2

Selects one of the following: **Preset Modes, Brightness/Contrast, Input Source, Aspect Ratio, Volume, PIP/PBP Mode, USB Select Switch, Video Swap** to set the **Shortcut key 2**.



Icon	Menu and Submenus	Description
	Power Button LED	Sets the power LED indicator On In On Mode or Off In On Mode to save energy.
	USB-C Charging	The default setting is Off in Off Mode . Selecting On in Off Mode may automatically charge your notebook or mobile devices through the USB-C cable even when the monitor is in off mode.
	Other USB Charging	Allows you to enable or disable USB Type-A (Downstream Ports) charging function during monitor standby mode.
	Reset Personalization	Resets all settings under the personalize menu to the default setting.

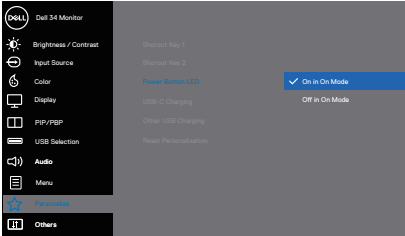

Icon **Menu and Submenus** **Description**



Others

Changes the OSD settings, such as the **DDC/CI**, **LCD conditioning**, and so on.

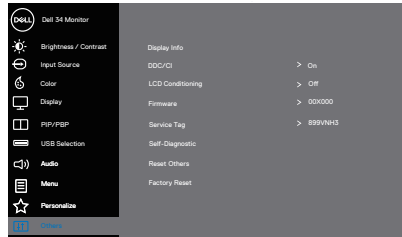

Display Info

Views the monitor's current settings.

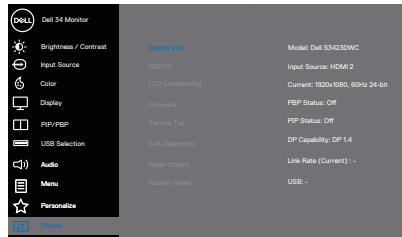



DDC/CI

DDC/CI (display data channel/command interface) allows your monitor parameters (brightness, color balance and etc.) to be adjusted using the software on your computer.

You can disable this feature by selecting **Off**.

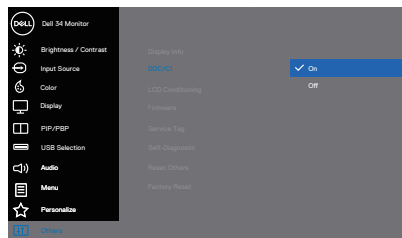
Enables this feature by selecting **On** for best user experience and optimum performance of your monitor.



Icon	Menu and Submenus	Description
	LCD Conditioning	Helps reduce minor cases of image retention. Depending on the degree of image retention, the program may take some time to run. To start LCD conditioning , select.
	Firmware	Views the firmware version of the display.
	Service Tag	Views the service tag number of the display. The Service Tag is a unique alphanumeric identifier that allows Dell to identify the product specifications and access warranty information.  NOTE: The Service Tag is also printed on a label located at the back of the cover.
	Self-Diagnostic	Allows you to check if your monitor is functioning properly.
	Reset Others	Resets all settings under the others setting menu to the factory preset values.
	Factory Reset	Restores all preset values to the factory default settings.

 **NOTE: Your monitor has a built-in feature to automatically calibrate the brightness to compensate for LED aging.**



Menu and Power button lock

Prevents users to access or change OSD menu settings on the display.

By default, the Menu and Power button lock setting is disabled.

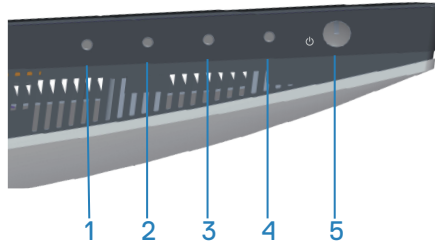

To access the Lock menu, press and hold the **Exit** button (button 4) for four seconds. A Lock menu appears at the bottom right corner of the display.

NOTE: The Lock menu can be accessed using this method when the Menu and Power buttons are in unlocked state.

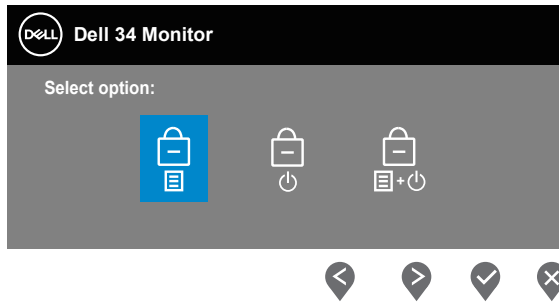

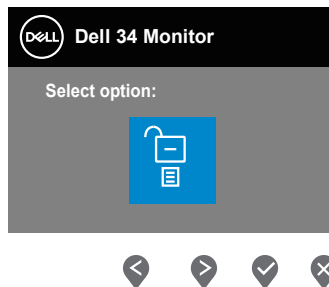

To access the Unlock menu, press and hold the **Exit** button (button 4) for four seconds. An Unlock menu appears at the bottom-right corner of the display.

NOTE: The Unlock menu can be accessed when the Menu buttons are in locked state.



There are three lock options.

	Menu	Description
1	Menu Buttons 	When Menu Buttons is selected, the OSD menu settings cannot be changed. All buttons are locked except Power button.
2	Power Button 	When Power Button is selected, the display cannot be turned off using the Power button.
3	Menu + Power Buttons 	When Menu + Power Buttons is selected, the OSD menu settings cannot be changed and the Power button is locked.

 **NOTE: To access the Lock or Unlock menu – Press and hold the Exit button (button 4) for four seconds.**

In the following scenarios, the  icon appears at the center of the display:

- When Up button (button 1), Down button (button 2), Menu button (button 3), or Exit button (button 4) are pressed. This indicates the OSD menu buttons are in lock state.
- When the Power button (button 5) is pressed. This indicates the Power button is in lock state.
- When any one of the five buttons are pressed. This indicates OSD menu buttons and the Power button are in lock state.

Unlocking the OSD menu and Power buttons:

1. Press and hold the Exit button (button 4) for four seconds. The Unlock menu appears.
2. Select the Unlock icon  to unlock the buttons on the display.



OSD warning messages

When the monitor does not support a particular resolution mode, the following message is displayed:

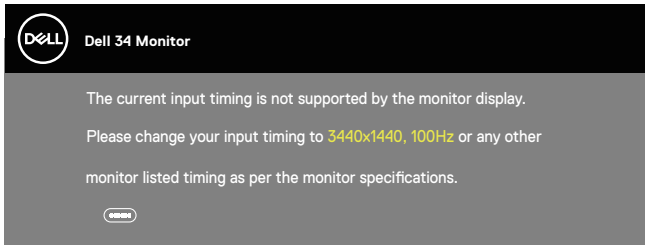

This means that the monitor cannot synchronize with the signal that it is receiving from the computer. See [Monitor specifications](#) for the Horizontal and Vertical frequency ranges addressable by this monitor. Recommended mode is 3440 x 1440.

Before the **DDC/CI** function is disabled, the following message is displayed:

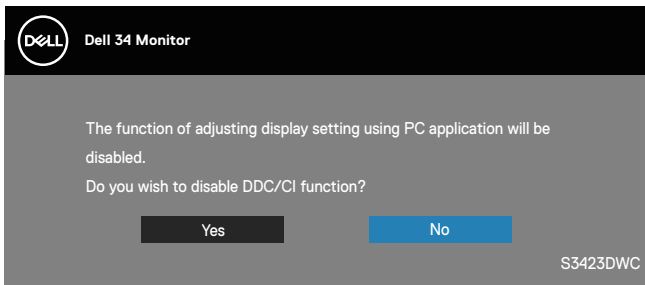

When the monitor enters the **Standby Mode**, the following message is displayed:

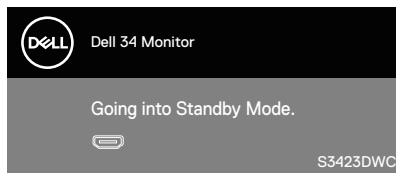

If you press any button other than the power button, the following messages are displayed depending on the selected input:

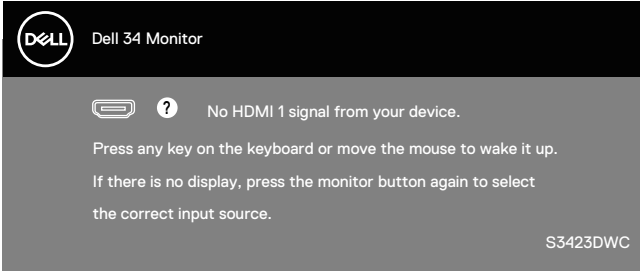

If an HDMI or USB-C cable is not connected, a dialog box as shown below is displayed. The monitor will enter Standby Mode after 4 minutes if left at this state.

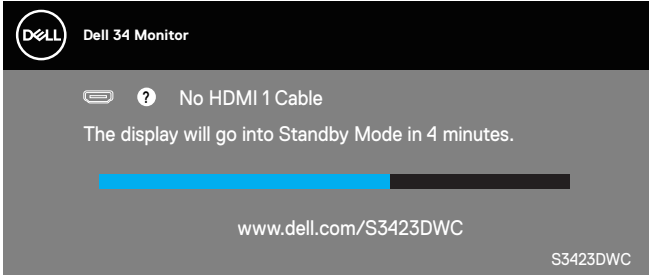

or

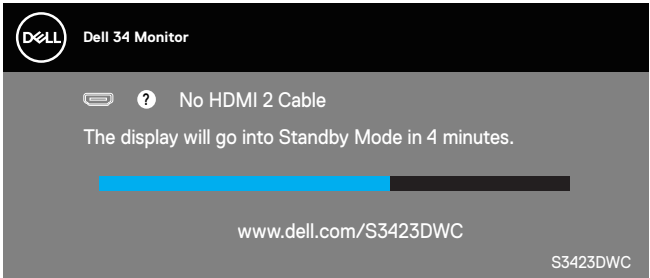

or



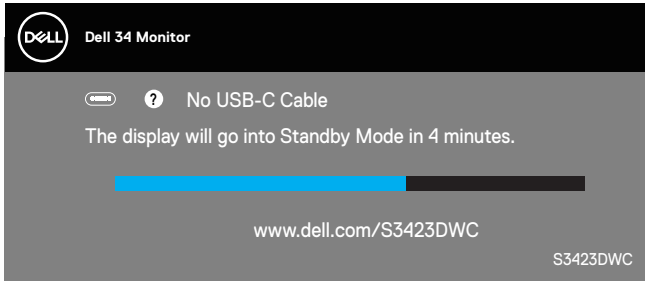

The OSD functions only in the normal operation mode. When any button is pressed in the Active-off mode, the following message is displayed:

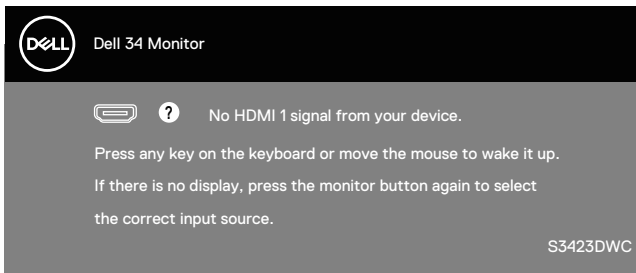

Activate the computer and the monitor to gain access to the OSD.
See [Troubleshooting](#) for more information.



Setting the maximum resolution

 **NOTE: The steps may vary slightly depending on the version of Windows you have.**

To set the maximum resolution for the monitor:

In Windows 8.1:

3. For Windows 8.1, select the Desktop tile to switch to the Classic desktop.
4. Right-click the desktop and click **Screen Resolution**.
5. If you have more than one monitor connected, ensure that you select **S3423DWC**.
6. Click the **Screen Resolution** drop-down list and select **3440 x 1440**.
7. Click **OK**.

In Windows 10 and Windows 11:

8. Right-click the desktop and click **Display settings**.
9. If you have more than one monitor connected, ensure to select **S3423DWC**.
10. Click the **Display Resolution** drop-down list and select **3440 x 1440**.
11. Click **Keep changes**.

If you do not see **3440 x 1440** as an option, you must update your graphics driver to the latest version. Depending on your computer, complete one of the following procedures:

If you have a Dell desktop or portable computer:

- Go to <https://www.dell.com/support>, enter your service tag, and download the latest driver for your graphics card.

If you are using a non-Dell computer (laptop or desktop):

- Go to the support site for your computer and download the latest graphic drivers.
- Go to your graphics card website and download the latest graphic drivers.





Setting the KVM switch

The built-in KVM switch allows you to control up to 2 computers from a single set of keyboard and mouse connected to the monitor.

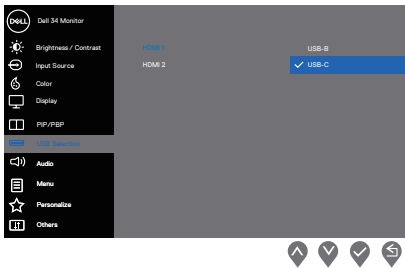
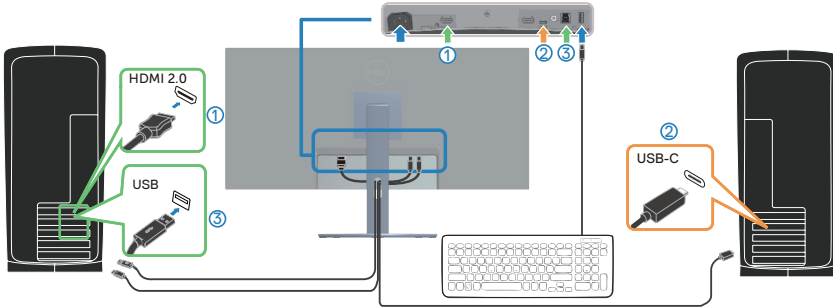
When connecting HDMI + USB-B to computer 1 and USB-C to computer 2, make sure **USB** for **HDMI** is assigned to **USB-B** .



-  **NOTE:** The USB-C connection currently supports video and data transfer.
-  **NOTE:** As the USB-C port supports the USB-C Alternate Mode, there is no need to set USB for USB-C.
-  **NOTE:** When connecting to different video input sources not shown above, follow the same method to make correct settings for USB to pair the ports.



Setting the Auto KVM

You can follow below instruction to set up Auto KVM for your monitor:

1. Ensure that **PIP/PBP Mode** is **Off**.

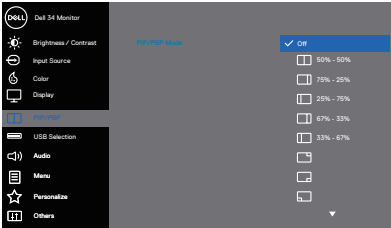

2. Ensure that **Auto Select** is **On** and **Auto Select for USB-C** is **Yes**.

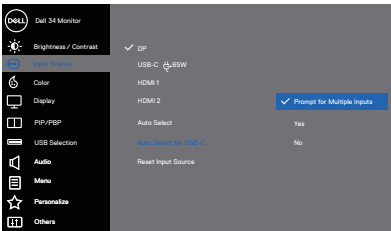
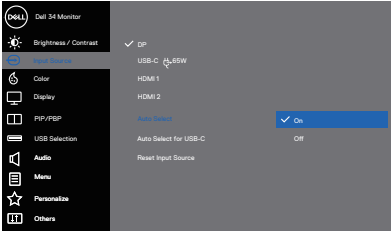

3. Ensure that the USB ports and the video inputs are paired accordingly.

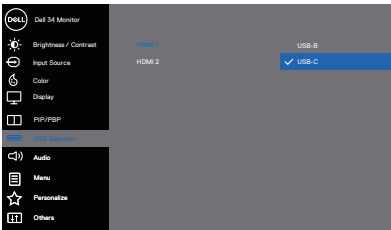

NOTE: For USB-C connection, there is no further setting required.



Using the tilt and vertical extension

 **NOTE:** These values are applicable to the stand that was shipped with your monitor. To set up with any other stand, see the documentation that shipped with the stand.

Tilt extension

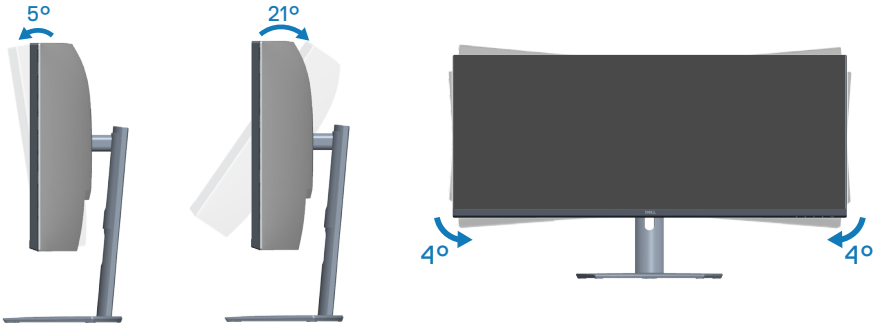

 **NOTE:** The stand is detached when the monitor is shipped from the factory.

 **NOTE:** The slant angle of this monitor is between -4° and $+4^{\circ}$, not allowing for pivot movements.

Vertical extension

 **NOTE:** The stand can be extended vertically up to 100 mm.



Troubleshooting

 **WARNING:** Before you begin any of the procedures in this section, follow the [Safety instructions](#).

Self-test

Your monitor provides a self-test feature that allows you to check if your monitor is functioning properly. If your monitor and computer are properly connected but the monitor screen remains dark, run the monitor self-test by performing the following steps:

1. Turn off both your computer and the monitor.
2. Disconnect all video cables from the monitor. This way, the computer does not have to be involved.
3. Turn on the monitor.

If the monitor is working correctly, it detects that there is no signal, and one of the following messages appears. While in self-test mode, the power LED remains white.

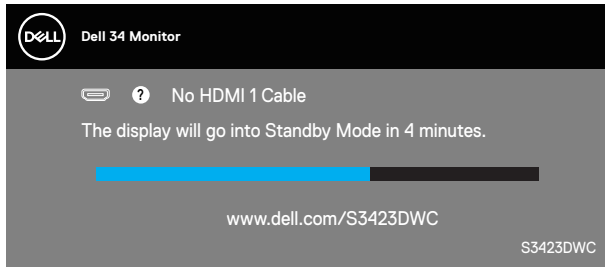

(or)

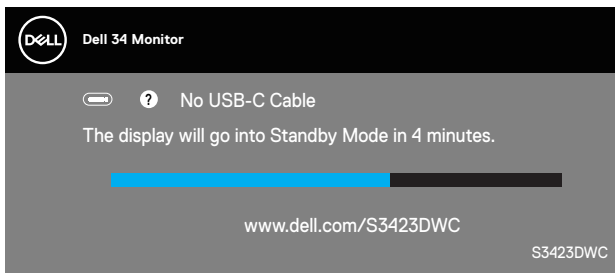

 **NOTE:** This box also appears during normal system operation, if the video cable is disconnected or damaged.



4. Turn off your monitor and reconnect the video cable; and then turn on your computer and the monitor.

If your monitor remains dark after you reconnect the cables, check your video controller and computer.

Built-in diagnostics

Your monitor has a built-in diagnostic tool. It helps you determine if the screen abnormality that you are experiencing is an inherent problem with your monitor, or with your computer and video card.

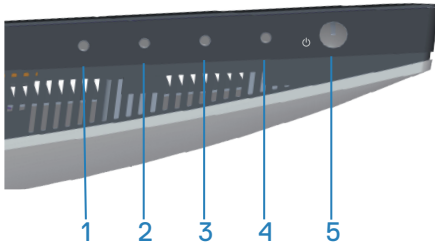

To run the built-in diagnostics:

1. Ensure that the screen is clean (no dust particles on the surface of the screen).
2. Press the  button (button three) to launch the OSD menu.
3. Using the front-panel buttons, select **Others > Self-Diagnostic** to initiate the self-diagnostic process.

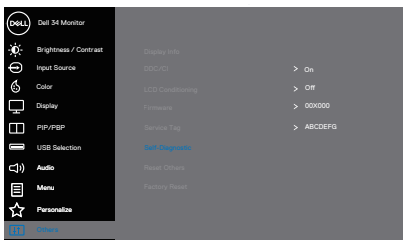

4. When initiated, a gray screen appears. Inspect the screen for abnormalities.
5. Press button 1 on the front-panel. The color of the screen changes to red. Inspect the screen for abnormalities.



6. Repeat step 5 and inspect the screen when it displays the green, blue, black, and white colors, followed by onscreen text.
7. The test is complete when the onscreen text appears. To exit, press the front-panel buttons again.

If you do not detect any screen abnormalities upon using the Built-in diagnostics-tool, the monitor is functioning properly. Check the video card and computer.



Common problems

The following table contains general information about common monitor problems you might encounter and the possible solutions:

Common Symptoms	Possible Solutions
No video or power LED off	<ul style="list-style-type: none">• Ensure that the video cable connecting the monitor and the computer is properly connected and secure.• Verify that the power outlet is functioning properly using any other electrical equipment.• Ensure that the power button is pressed.• Ensure that the correct input source is selected using the Input Source menu.
No video or power LED on	<ul style="list-style-type: none">• Increase brightness and contrast controls using the OSD.• Perform monitor self-test feature check.• Check for bent or broken pins in the video cable connector.• Run the built-in diagnostics.• Ensure that the correct input source is selected using the Input Source menu.
Poor focus	<ul style="list-style-type: none">• Eliminate video extension cables.• Reset the monitor to factory settings (Factory Reset).• Change the video resolution to the correct aspect ratio.
Shaky or jittery Video	<ul style="list-style-type: none">• Reset the monitor to factory settings (Factory Reset).• Check environmental factors.• Relocate the monitor, and test in another room.
Missing pixels	<ul style="list-style-type: none">• Cycle power On-Off.• Pixel that is permanently Off is a natural defect that can occur in LCD technology.• For more information on Dell Monitor Quality and Pixel Policy, see Dell Support site at: www.dell.com/support/monitors.



Common Symptoms	Possible Solutions
Stuck-on pixels	<ul style="list-style-type: none"> . Cycle power On-Off. . Pixel that is permanently off is a natural defect that can occur in LCD technology. . For more information on Dell Monitor Quality and Pixel Policy, see Dell Support site at: www.dell.com/support/monitors
Brightness problems	<ul style="list-style-type: none"> . Reset the monitor to factory settings (Factory Reset). . Adjust brightness & contrast controls using OSD.
Geometric distortion	<ul style="list-style-type: none"> . Reset the monitor to factory settings (Factory Reset). . Adjust horizontal & vertical controls using OSD.
Horizontal or vertical Lines	<ul style="list-style-type: none"> . Reset the monitor to factory settings (Factory Reset). . Perform monitor self-test feature check and determine if these lines are also in self-test mode. . Check for bent or broken pins in the video cable connector. . Run the built-in diagnostics.
Synchronization problems	<ul style="list-style-type: none"> . Reset the monitor to factory settings (Factory Reset). . Perform monitor self-test feature check to determine if the scrambled screen appears in self-test mode. . Check for bent or broken pins in the video cable connector. . Restart the computer in the safe mode.
Safety-related issues	<ul style="list-style-type: none"> . Do not perform any troubleshooting steps. . Contact Dell immediately.
Intermittent problems	<ul style="list-style-type: none"> . Ensure that the video cable connecting the monitor to the computer is connected properly and is secure. . Reset the monitor to factory settings (Factory Reset). . Perform monitor self-test feature check to determine if the intermittent problem occurs in self-test mode.



Common Symptoms	Possible Solutions
Missing color	<ul style="list-style-type: none"> . Perform monitor self-test feature check. . Ensure that the video cable connecting the monitor to the computer is connected properly and is secure. . Check for bent or broken pins in the video cable connector.
Wrong color	<ul style="list-style-type: none"> . Try different Preset Modes in Color settings OSD. Adjust R/G/B value in Custom Color in Color settings OSD. . Change the Input Color Format to RGB or YCbCr in the Color settings OSD. . Run the built-in diagnostics.
Image retention from a static image left on the monitor for a long period of time	<ul style="list-style-type: none"> . Set the screen to turn off after a few minutes of screen idle time. These can be adjusted in Windows Power Options or Mac Energy Saver setting. . Alternatively, use a dynamically changing screensaver.
Video ghosting or overshooting	<ul style="list-style-type: none"> . Change the Response Time in the Display OSD to Normal, Fast or Extreme depending on your application and usage.



Product-specific problems

Specific Symptoms	Possible Solutions
Screen image is too small	<ul style="list-style-type: none">• Check the Aspect Ratio setting in the Display settings OSD.• Reset the monitor to factory settings (Factory Reset).
Cannot adjust the monitor with the buttons on the bottom of the panel	<ul style="list-style-type: none">• Turn off the monitor, unplug the power cord, plug it back, and then turn on the monitor.• Check if the OSD menu is locked. If yes, press and hold the menu button for six seconds to unlock.
No input signal when user controls are pressed	<ul style="list-style-type: none">• Check the signal source. Ensure that the computer is not in standby or sleep mode by moving the mouse or pressing any key on the keyboard.• Check if the video cable is plugged in properly. Disconnect and reconnect the video cable if necessary.• Reset the computer or video player.
The picture does not fill the entire screen	<ul style="list-style-type: none">• Due to different video formats (aspect ratio) of DVDs, the monitor may display in full screen.• Run the built-in diagnostics.



Regulatory information

FCC notices (U.S. Only) and other regulatory information



For FCC notices and other regulatory information, see the regulatory compliance website located at www.dell.com/regulatory_compliance.

EU product database for energy label and product information sheet

S3423DWC: <https://eprel.ec.europa.eu/qr/1107221>.

Contacting Dell

To contact Dell for sales, technical support, or customer service issues, see www.dell.com/contactdell.

-  **NOTE: Availability varies by country and product, and some services may not be available in your country.**
-  **NOTE: If you do not have an active Internet connection, you can find contact information on your purchase invoice, packing slip, bill, or Dell product catalog.**

