

User's Manual

DuraVision® FDF2382WT

Touch Panel Color LCD Monitor

Important

Please read this "User's Manual", and "PRECAUTIONS" (separate volume) carefully to familiarize yourself with safe and effective usage.

-
- Refer to the "Setup Guide" for information on the installation / connection of the monitor.
 - For the latest product information including the "User's Manual", refer to our web site :
www.eizoglobal.com
-



Location of Caution Statement

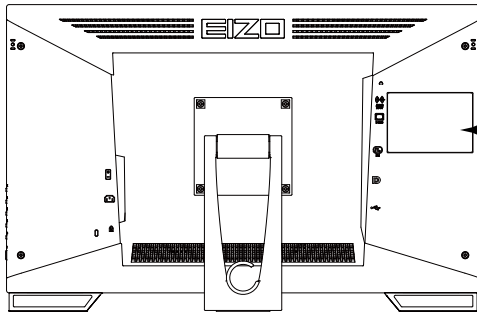



WARNING
RISK OF ELECTRIC SHOCK. DO NOT OPEN.

AVERTISSEMENT
RISQUE DE CHOC ELECTRIQUE. NE PAS OUVRIR.







WARNUNG
GEFAHR DES ELEKTRISCHEN SCHLAGES. RÜCKWAND NICHT ENTFERNEN.

警告
触电危険、请勿打开后盖。

警告
感電の恐れあり、カバーをあけないでください。

The equipment must be connected to a grounded main outlet.
L'appareil doit être relié à une prise avec terre.
Jordet stikkontakt skal benyttes når apparatet tilkobles datanett.
Apparaten skall anslutas till jordat nätuttag.
设备必须连接到接地地的电源插座。
電源コードのアースは必ず接地してください。

Symbols on the unit

Symbol	This symbol indicates
	Power button Press to turn the monitor's power on or off.
	Alternating current
	Alerting electrical hazard
	CAUTION Refer to SAFETY SYMBOLS section in PRECAUTIONS.
	WEEE marking Product must be disposed of separately; materials may be recycled.
	CE marking EU conformity mark in accordance with the provisions of Council Directive 93/42/EEC and 2011/65/EU.

This product has been adjusted specifically for use in the region to which it was originally shipped. If operated outside this region, the product may not perform as stated in the specifications.

No part of this manual may be reproduced, stored in a retrieval system, or transmitted, in any form or by any means, electronic, mechanical, or otherwise, without the prior written permission of EIZO Corporation. EIZO Corporation is under no obligation to hold any submitted material or information confidential unless prior arrangements are made pursuant to EIZO Corporation's receipt of said information. Although every effort has been made to ensure that this manual provides up-to-date information, please note that EIZO monitor specifications are subject to change without notice.

Notice for This Monitor

This product is suited to general purposes like creating documents, viewing multimedia content (Assuming usage of approximately 12 hours per day).

This product has been adjusted specifically for use in the region to which it was originally shipped. If the product is used outside the region, it may not operate as specified in the specifications.

This product may not be covered by warranty for uses other than those described in this manual.

The specifications noted in this manual are only applicable when the following are used:

- Power cords provided with the product
 - Signal cables specified by us
-

Only use optional products manufactured or specified by us with this product.

If you place this product on a lacquer-coated desk, the color may adhere to the bottom of the stand due to the composition of the rubber. Check the desk surface before use.

It takes about 30 minutes for the performance of electrical parts to stabilize. Please wait 30 minutes or more after the monitor power has been turned on, and then adjust the monitor.

Monitors should be set to a lower brightness to reduce changes in luminosity caused by long-term use and maintain a stable display.

When the screen image is changed after displaying the same image for extended periods of time, an afterimage may appear. Use the screen saver or power save function to avoid displaying the same image for extended periods of time. Depending on the image, an afterimage may appear even if it was displayed for a short period of time. To remove such a phenomenon, change the image or keep the power turned off for several hours.

If the monitor displays continuously over a long period of time, dark smudges or burn-in may appear. To maximize the life of the monitor, we recommend the monitor be turned off periodically.

Periodic cleaning is recommended to keep the monitor looking new and to prolong its operation lifetime (refer to [“Cleaning” \(page 4\)](#)).

The LCD panel is manufactured using high-precision technology. Although, missing pixels or lit pixels may appear on the LCD panel, this is not a malfunction. Percentage of effective dots: 99.9994 % or higher.

The backlight of the LCD panel has a fixed lifetime. Depending on the usage pattern, such as usage for long continuous periods, the lifespan of the backlight may run out sooner, requiring replacement. When the screen becomes dark or begins to flicker, please contact your local EIZO representative.

Do not scratch or press on the LCD panel with any sharp objects, at this may result in damage to the LCD panel. Do not attempt to brush with tissues as this may scratch the panel.

When the monitor is cold and brought into a room or the room temperature goes up quickly, dew condensation may occur on the interior and exterior surfaces of the monitor. In that case, do not turn the monitor on. Instead wait until the dew condensation disappears, otherwise it may cause some damage to the monitor.

(Cautions for the Use of the Touch Panel)

During touch operation

Be careful of the following points. Otherwise, damage may occur to the monitor.

- Do not strongly press, scratch, or poke the panel.
 - Do not touch the panel with hard objects such as ballpoint pens or metals.
-

Cleaning

The stains on the cabinet and LCD panel surface can be removed by using the provided cleaning cloth.

Attention

- Do not allow liquid to enter the clearance between the panel and the panel frame.
 - Chemicals such as alcohol and antiseptic solution may cause gloss variation, tarnishing, and fading of the cabinet or LCD panel, and also quality deterioration of the image.
 - Never use thinner, benzine, wax, or abrasive cleaner as they may damage the cabinet or LCD panel surface.
-

To Use the Monitor Comfortably

- An excessively dark or bright screen may affect your eyes. Adjust the brightness of the monitor according to the environmental conditions.
- Staring at the monitor for a long time tires your eyes. Take a 10-minute rest every hour.

CONTENTS

Notice for This Monitor	3	4-6. Monitor Settings	23
Cleaning	4	● Input Signal	23
To Use the Monitor Comfortably	4	● Power Indicator	23
CONTENTS	5	● Languages	23
Chapter 1 Introduction	6	● Menu Settings	24
1-1. Features	6	● Reset	24
● Full-flat Design	6	4-7. Information	24
● Easy-to-touch Stand Mechanism.....	6	4-8. Locking Operation Buttons	24
● 10-point Multi-touch Function	6	Chapter 5 Troubleshooting	25
1-2. Controls and Functions	7	5-1. No Picture	25
● Front	7	5-2. Imaging Problems (b for both digital and analog)	26
● Rear.....	8	5-3. Imaging Problems (for analog only)	27
1-3. Attaching the Touch Pen Holder	9	5-4. Imaging Problems (for digital only)	27
1-4. EIZO LCD Utility Disk	9	5-5. Touch Panel Problems	28
● Disk Contents and Software Overview	9	5-6. Other Problems	30
Chapter 2 Basic Adjustment / Setting	10	Chapter 6 Reference	31
2-1. Enabling or Disabling the Touch Panel	10	6-1. Attaching the Optional Arm	31
2-2. Switching the Input Signal	10	6-2. Connecting Multiple PCs	33
2-3. Adjusting Brightness	11	6-3. Specifications	34
2-4. Adjusting Volume	11	● Compatible Resolutions	35
Chapter 3 Touch Panel Settings	12	● Main Default Settings.....	36
3-1. Touch Panel Setting Method	12	● Accessories.....	36
3-2. Adjusting the Touch Position	12	Appendix	37
3-3. Configuring Touch Panel Operation Settings	14	Trademark	37
Chapter 4 Advanced Adjustment / Setting	15	License	37
4-1. Basic Operation of the Setting Menu	15	FCC Declaration of Conformity	38
4-2. Color	16	LIMITED WARRANTY	39
● Color Mode.....	16	Recycling Information	40
● Brightness	16		
● Contrast.....	17		
● Temperature	17		
● Gamma.....	17		
● Advanced Settings	18		
● Color Reset	18		
4-3. Screen	19		
● Screen Size.....	19		
● Smoothing	19		
● Analog Adjustment.....	20		
4-4. Sound	21		
● Source	21		
4-5. PowerManager	22		
● Power Save	22		
● Eco Timer	22		

Chapter 1 Introduction

Thank you very much for choosing an EIZO color LCD monitor.

1-1. Features

● Full-flat Design

The full-flat design with no steps is adopted in the bezel part. You can securely touch up to each edge of the screen even with fingertips.

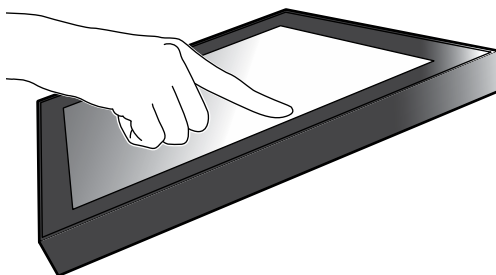

● Easy-to-touch Stand Mechanism

The tilt angle can be adjusted steplessly. You can smoothly change to the easy-to-work screen position to suit your needs such as for office work or multi-touch operations.

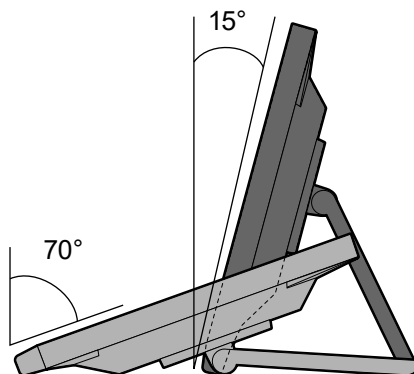

● 10-point Multi-touch Function

You can perform operations such as enlargement, reduction, and rotation using the multi-touch function. The touch panel reacts via light touching of the screen with fingers, thereby, enabling comfortable flick and drag operations.

Enlarge / Reduce

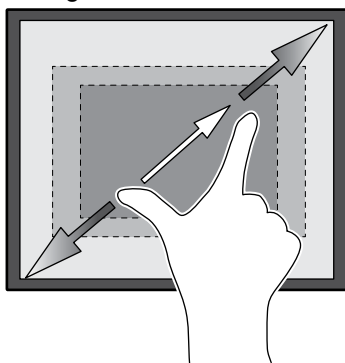



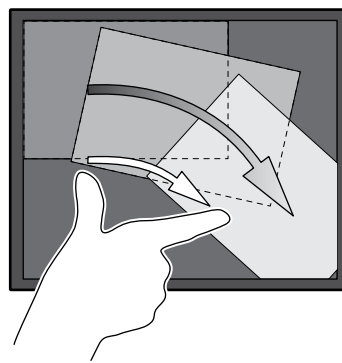



Rotate

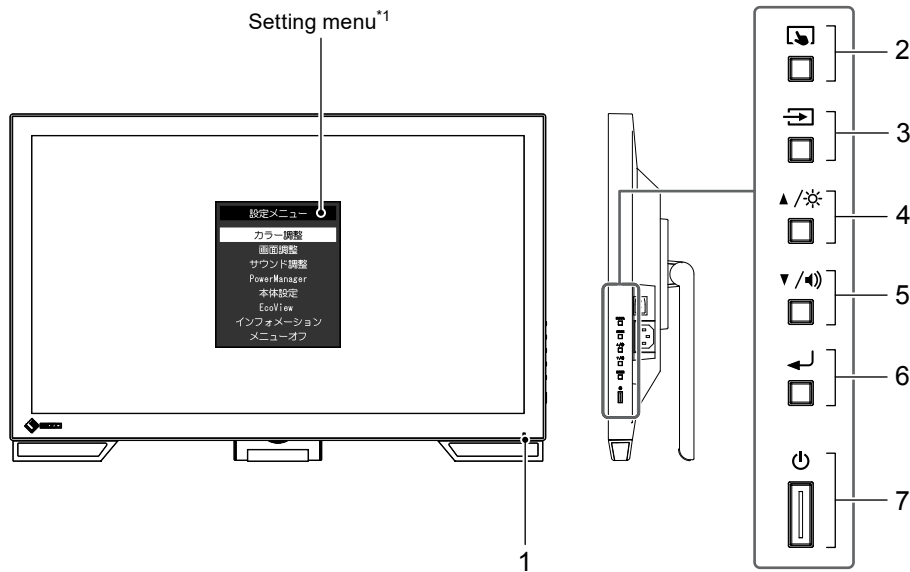

1-2. Controls and Functions

● Front



1. Power indicator	Indicates the monitor's operation status. Blue: Screen display Orange: Power saving mode OFF: Main power off / Power off
2.  button	Switches the touch panel enable and disable modes, or calibrates the touch sensitivity (page 10).
3.  button	Switches input signals for display (page 10).
4.  button*²	Provides an item selection and function adjustment or setting option while the Setting menu is displayed, and displays the brightness adjustment screen (page 11).
5.  button*²	Provides an item selection and function adjustment or setting option while the Setting menu is displayed, and displays the volume control screen (page 11).
6.  button	Displays the Setting menu, determines an adjustment item of each menu, and saves values adjusted (page 15).
7.  button	Turns the power on or off.

*1 For information on how to use, see "4-1. Basic Operation of the Setting Menu" ([page 15](#)).

*2 In this User's Manual, the  button may be hereafter simply referred as , and the  button as .

● Rear

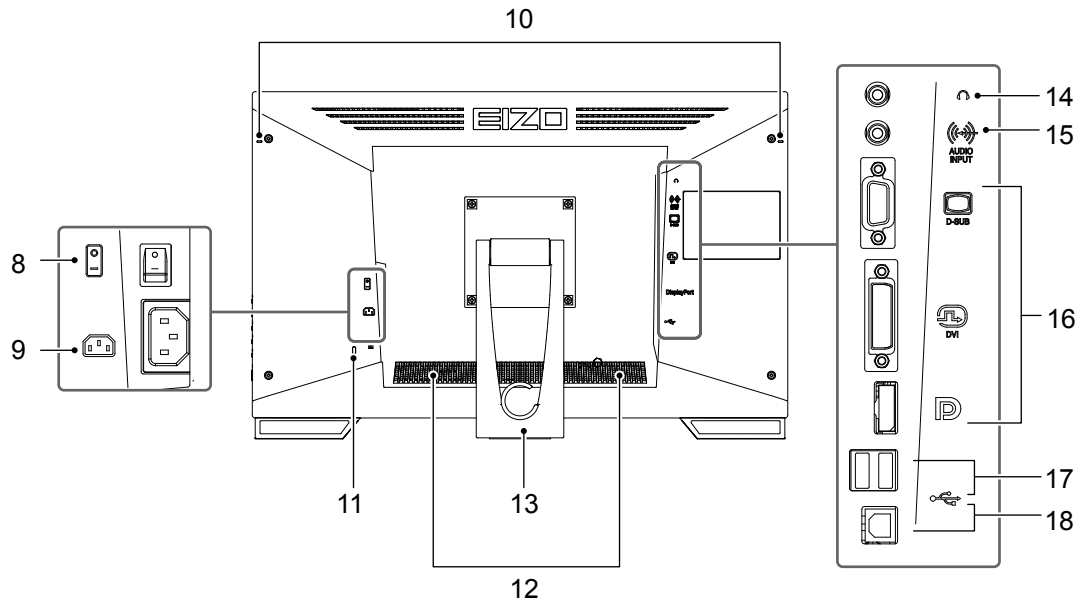

8. Main power switch	Turns the main power on or off. : ON, ○ : OFF
9. Power connector	Connects the power cord.
10. Touch pen holder attachment hole^{*3}	Used to attach a touch pen holder.
11. Security lock slot	Complies with Kensington's MicroSaver security system.
12. Speaker	Outputs audio source.
13. Stand (with cable holder)	Used to adjust the angle of the monitor screen.
14. Headphone jack	Connects the headphones.
15. Analog voice input connector	Outputs external voice from the monitor.
16. Input signal connector	Connect it to the PC. Upper port: D-Sub mini 15-pin connector Medium port: DVI-D connector Lower port: DisplayPort connector
17. USB downstream port	Connects a peripheral USB 2.0 device.
18. USB upstream port	Connects the USB cable for using the monitor as a touch panel monitor or for using the USB Hub function.

*3 The touch pen holder is supplied with the touch pen (Accessories (page 36)). For the attachment method, see "1-3. Attaching the Touch Pen Holder" (page 9).

1-3. Attaching the Touch Pen Holder

Note

- The touch pen holder is supplied with the touch pen (Accessories (“Accessories” (page 36))).

Attach the touch pen holder to any one of the right-hand and left-hand holes in the rear of the monitor. To fix the touch pen holder, use the screw supplied with the touch pen.

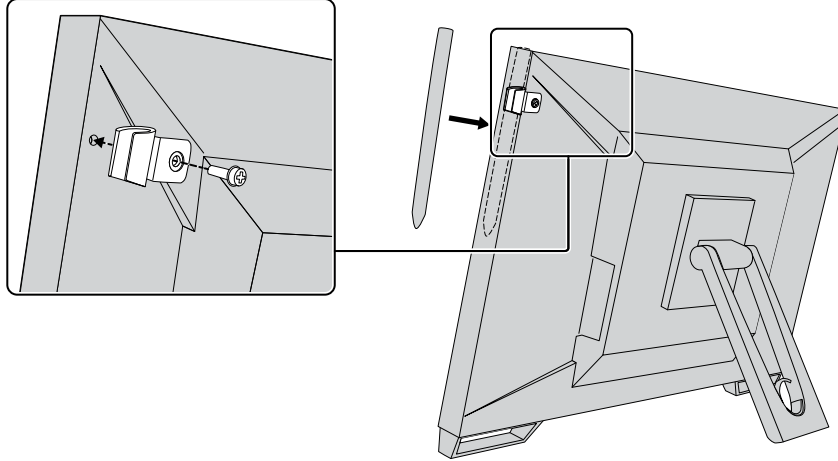

1-4. EIZO LCD Utility Disk

An "EIZO LCD Utility Disk" (CD-ROM) is supplied with this product. The following table shows the disk contents and the overview of the software programs.

● Disk Contents and Software Overview

The disk includes adjustment software, touch panel software, and User's Manual. For software startup procedures or file access procedures, see the Readme.txt file on the disk.

Item	Overview
Touch panel driver	Touch panel driver supplied by EIZO.* 1
TPOffset	Software for calibrating the sensitivity of the touch panel.* 1 Use this software when touch operations are not registered or only registered after pressing hard.
User's Manual of this monitor (PDF file)	
Outline dimensions	
Readme.txt file	

*1 Only for Windows. Refer to the corresponding User's Manual on the CD-ROM for details on installation and use.

Chapter 2 Basic Adjustment / Setting

2-1. Enabling or Disabling the Touch Panel

You can switch the touch panel enable and disable modes. This function is available when you want to temporarily display the touch panel function.

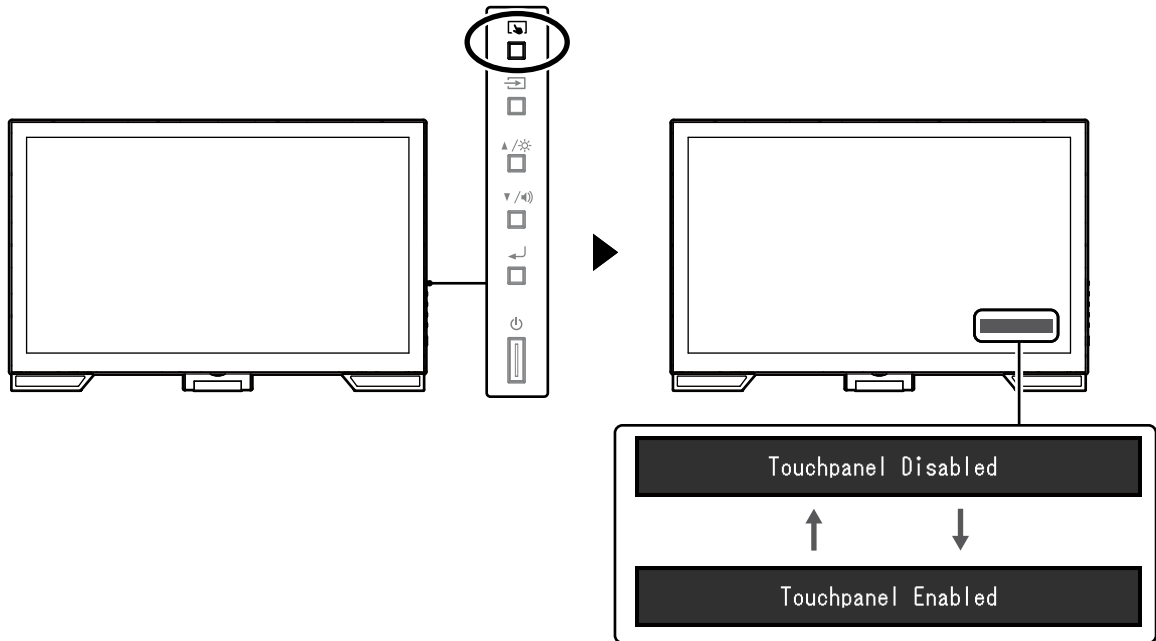

Note

- Holding down  allows you to calibrate the touch sensitivity.

2-2. Switching the Input Signal

When a monitor has multiple signal inputs, the signal to display on-screen can be changed. When the signal is switched, the active input port name appears at the top right corner of the screen.

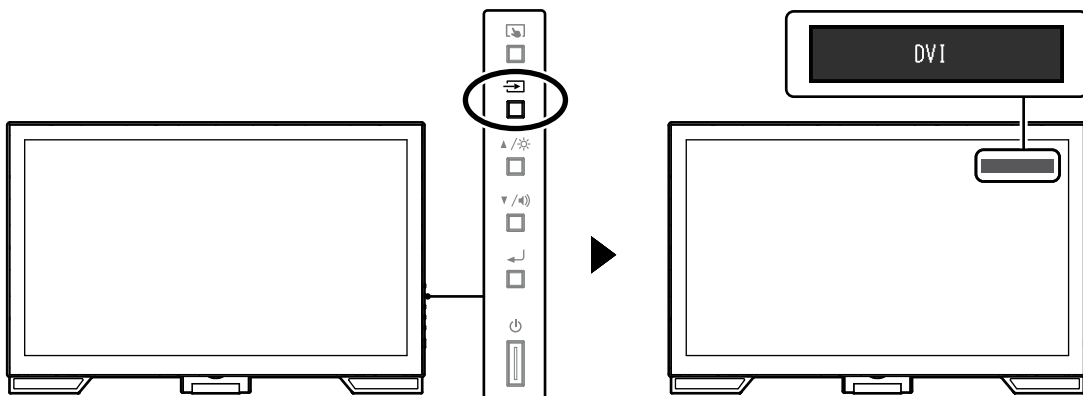

2-3. Adjusting Brightness

The brightness of the screen can be adjusted to suit the installation environment or personal preference. The screen brightness is adjusted by changing the brightness of the backlight (light source from the LCD back panel).

Adjustable range

0 to 100

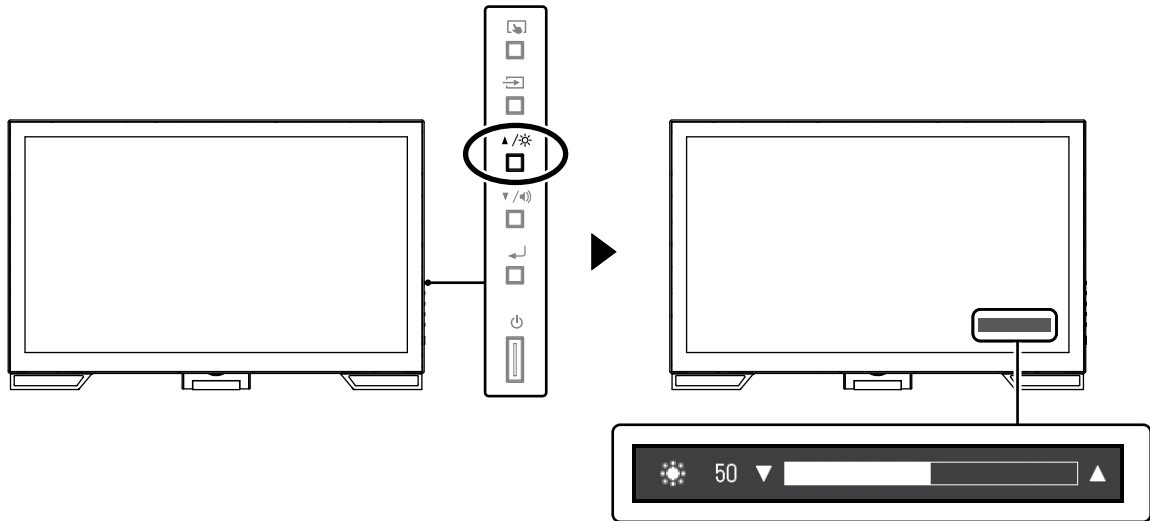

2-4. Adjusting Volume

You can individually tune the speaker or headphone volume.

Adjustable range

0 to 30

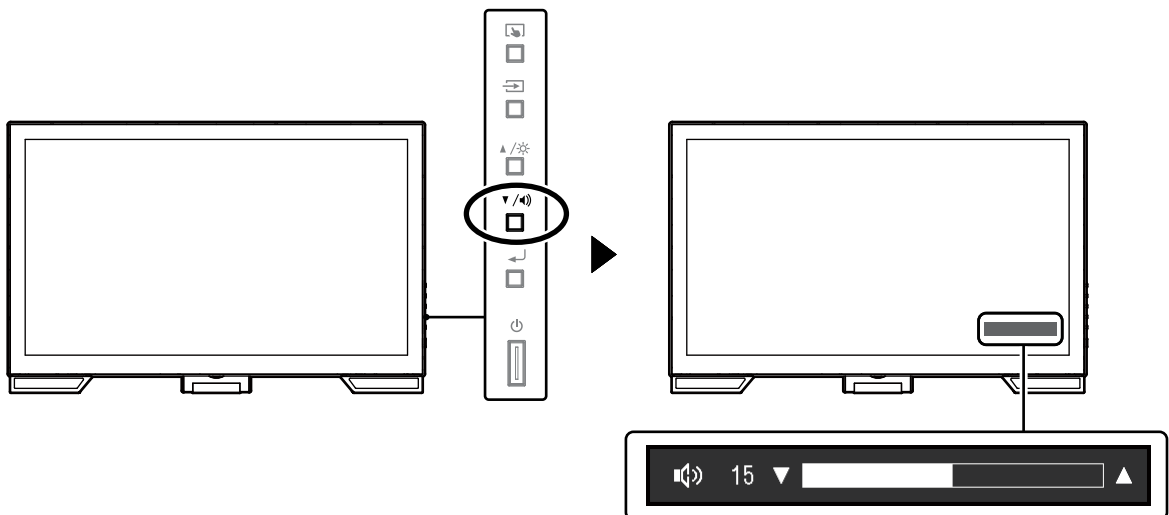

Chapter 3 Touch Panel Settings

3-1. Touch Panel Setting Method

This product's touch panel functions vary depending on the driver you use and its settings. Configure settings to meet your usage applications.

Function	Windows standard driver	Dedicated touch panel driver (DMT-DD) ^{*1}	
Driver installation	Not required	Required	
Touch sound output	x	√	
Multi-connection ^{*2}	△ ^{*3}	√	
Operation mode	Touch digitizer ^{*4}	Touch digitizer ^{*4, 5}	Mouse emulation ^{*5}
Multi-touch operation	√	√	x

*1 Included in the EIZO LCD Utility Disk (CD-ROM).

*2 √: Two or more monitors can be connected to a single computer.

*3 Only available in Windows 10.

*4 Touch operation may not be recognized on an application designed by mouse emulation.

*5 For more information about the setup procedure, see the touch panel driver's User's Manual (included on the CD-ROM).

Note

- When setting is completed, execute the "TPOffset" application included on the CD-ROM, and calibrate the sensitivity of the touch panel.

When using the Windows standard driver, configure settings, referring to the following information.

3-2. Adjusting the Touch Position

Make adjustments to align the touch position with the position of the cursor displayed in response to touching.

Attention

- Do not put your hands or any metal close to the screen because the screen is susceptible to electrical conductors.
- If a "User Account Control" dialog box is displayed during operation, proceed according to the displayed instructions.

1. Open Windows Control Panel.

The method for opening Control Panel differs depending on the operating system.

Windows 10

1. Open the Start menu, and click "All apps" - "Windows System" - "Control Panel".

Windows 8.1

1. Click  at the bottom of the "Start" screen.
The "Apps" screen appears.
2. Click "Control Panel" under "Windows System".

Windows 7

1. Click "Start" - "Control Panel".

2. Click "Hardware and Sound" - "Tablet PC Settings".

The "Tablet PC Settings" window appears.

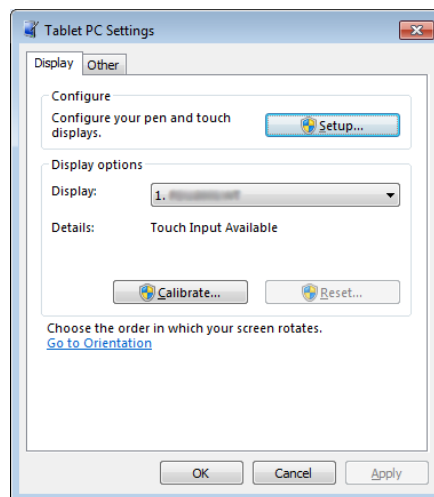

3. Click "Setup" in the "Display" tab.

A touchscreen specification screen with a white background is displayed.

Attention

- If using the monitor in a multiple monitor environment, specify the touchscreen according to the message displayed on screen.

4. Touch the screen with your finger.

The touched screen is recognized as a touchscreen.

5. Press "Enter" on the keyboard.

The "Tablet PC Settings" window reappears.

6. Click "Calibrate".

A screen with a white background is displayed.

Attention

- If using the monitor in a multiple monitor environment, select the monitor to calibrate the touch position for the "Display" pull-down menu, and then click "Calibrate".

7. Touch the calibration target (cross) for a few seconds with your finger and release.

The calibration target appears on the screen 16 times, starting from the top left to top right and then down to the bottom left to bottom right.

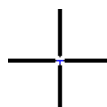

Note

- For second or subsequent calibrations, the calibration target appears 4 times.

8. After the touch position calibration has been completed, click "Yes" to save the calibration data.

9. Click "OK" to close the window.

3-3. Configuring Touch Panel Operation Settings

1. Open Windows Control Panel.

The method for opening Control Panel differs depending on the operating system. (See [page 12](#))

2. Click "Hardware and Sound" - "Pen and Touch".

"Pen and Touch" window appears.

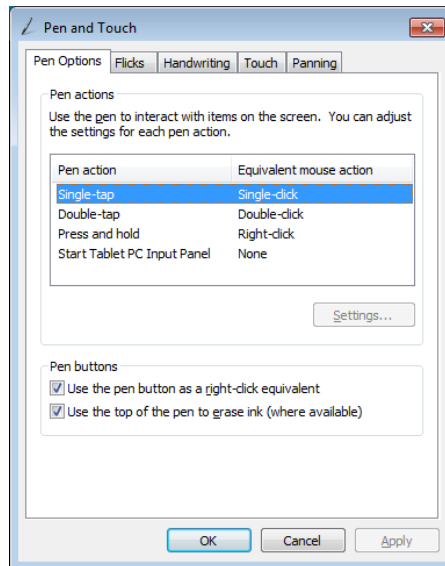

Configure the touch panel operation settings in the "Pen and Touch" window. For detailed settings, refer to the settings on each tab and Windows Help.

3. After settings have been completed, click "OK" to close the window.

Chapter 4 Advanced Adjustment / Setting

This chapter describes the advanced monitor adjustment and setting procedures using the Setting menu.

4-1. Basic Operation of the Setting Menu

1. Displaying the Setting menu

1. Press \leftarrow to open the Setting menu.

2. Adjustment / Setting

1. Use \blacktriangle \blacktriangledown to select a menu to adjust or set, and press \leftarrow . The Sub menu appears.

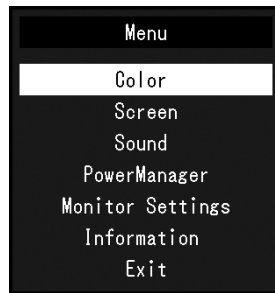

2. Use \blacktriangle \blacktriangledown to select an item to adjust or set, and press \leftarrow . The adjustment / setting menu appears.

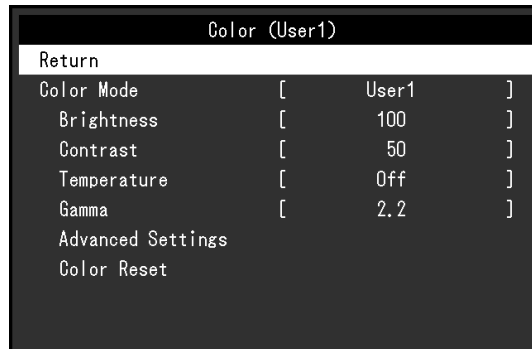

3. Use \blacktriangle \blacktriangledown to perform adjustment / setting, and press \leftarrow to apply the setting.



3. Exiting

1. Select "Return" from the Sub menu, and press \leftarrow . The Setting menu appears.
2. Select "Exit" in the Setting menu, and press \leftarrow . The Setting menu exits.

Note

- The Setting menu can also be exited by pressing \leftarrow twice quickly.

4-2. Color

Color (User1)		
Return		
Color Mode	[User1]
Brightness	[100]
Contrast	[50]
Temperature	[Off]
Gamma	[2.2]
Advanced Settings		
Color Reset		

● Color Mode

This function allows easy selection of a desired mode according to monitor application.

Mode	Purpose
User1	Select this to define a desired set of parameter settings.
User2	
sRGB	Suitable for color matching with sRGB compatible peripherals.

Functions that can be adjusted differ depending on the color mode.

√: Adjustable -: Not adjustable

Function	Color Mode		
	User1	User2	sRGB
Brightness	√	√	√
Contrast	√	√	-
Temperature	√	√	-
Gamma	√	√	-
Advanced Settings	Hue	√	-
	Saturation	√	-
	Overdrive	√	-
	Gain	√	-
Reset	√	√	√

Attention

- It takes about 30 minutes for the performance of electrical parts to stabilize. Please wait 30 minutes or more after the monitor power has been turned on, and then adjust the monitor.
- Perform the range adjustment first when adjusting color for analog signals (see “Auto Range Adjust” (page 20)).
- The same image may be seen in different colors on multiple monitors due to their monitor-specific characteristics. Make fine color adjustment visually when matching colors on multiple monitors.

● Brightness

The screen brightness is adjusted by changing the brightness of the backlight (light source from the LCD back panel).

Adjustable range

0 to 100

Note

- If you feel that the image is too dark even if the brightness is set to 100, adjust the contrast.

● Contrast

The brightness of the screen is adjusted by varying the video signal level.

Adjustable range

0 to 100

Note

- In the contrast of 50, every color gradation is displayed.
 - When adjusting the monitor, it is recommended to perform the brightness adjustment which may not lose the gradation characteristics, prior to the contrast adjustment.
 - Perform the contrast adjustment in the following cases.
 - If the image is too dark even when the brightness is set to 100 (Set the contrast to higher than 50.)
-

● Temperature

Color temperature can be adjusted.

The color temperature is normally used to express the hue of "White" and / or "Black" by a numerical value. The value is expressed in degrees "K" (Kelvin).

The screen becomes reddish at a low color temperature, and bluish at a high color temperature, like the flame temperature. The gain preset values are set for each color temperature setting value.

Adjustable range

Off / 4000 K to 10000 K (specified by every 500 K unit, including 9300 K)

Note

- The value shown in "K" is available only as reference.
 - Selecting "Advanced Settings" - "Gain" allows you to perform more advanced adjustment (see ["Gain" \(page 18\)](#)).
 - If you set to "Off", the image is displayed in the preset color of the monitor (Gain: 100 for each RGB).
 - When gain is changed, the color temperature is changed to "Off".
-

● Gamma

Gamma can be adjusted. The brightness of the monitor varies depending on the input signal, however, the variation rate is not proportional to the input signal. Maintaining the balance between the input signal and the brightness of the monitor is called "Gamma correction".

Adjustable range

1.8 / 2.0 / 2.2

Note

- If "sRGB" is selected for the color mode, "2.2" is displayed for the gamma value.
-

● Advanced Settings

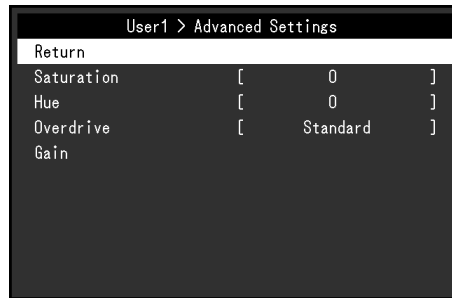

Function	Adjustable range	Description
Saturation	-50 to 50	<p>This function allows you to adjust color saturation.</p> <p>Note</p> <ul style="list-style-type: none"> Using this function may prevent some color gradations from being able to be displayed. The minimum value (-50) changes the screen to monochrome.
Hue	-50 to 50	<p>This function allows you to adjust hue.</p> <p>Note</p> <ul style="list-style-type: none"> Using this function may prevent some color gradations from being able to be displayed.
Overdrive	Enhanced / Standard / Off	<p>This function allows you to set overdrive intensity based on the use of the monitor.</p> <p>You can reduce image lags by setting it to "Enhanced" when displaying animated images.</p> <p>Note</p> <ul style="list-style-type: none"> The overdrive function is disabled in the following cases: <ul style="list-style-type: none"> When the vertical scan frequency of input signals is more than 70 Hz When "Normal" or "Enlarged" is selected from "Screen Size" (excluding the case that display resolution is 1920 × 1080).
Gain	0 to 100	<p>The brightness of each color component red, green, and blue is called "Gain". You can change the hue of "white" by adjusting gain.</p> <p>Note</p> <ul style="list-style-type: none"> Using this function may prevent some color gradations from being able to be displayed. The value of gain changes with that of color temperature. When gain is changed, the color temperature is changed to "Off".

● Color Reset

Reset any color adjustments for the currently selected color mode back to the default settings.

4-3. Screen

For D-Sub signal input

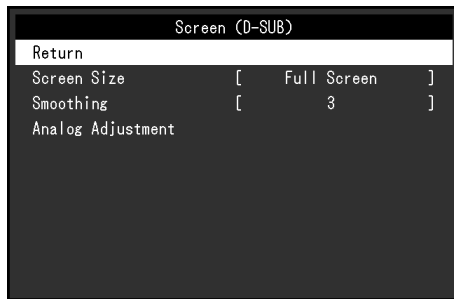

For DisplayPort or DVI signal input



● Screen Size

The image with the resolution other than the recommended resolution is displayed in full screen automatically. You can change the screen size by using the "Screen Size" function.

Settings	Function
Full Screen	Displays an image in full screen. Images are distorted in some cases because the vertical rate is not equal to the horizontal rate.
Enlarged	Displays an image in full screen. In some cases, a blank horizontal or vertical border appears to equalize the vertical rate and the horizontal rate.
Normal	Displays images with the specified resolution.

Example: Image size 1024 × 768

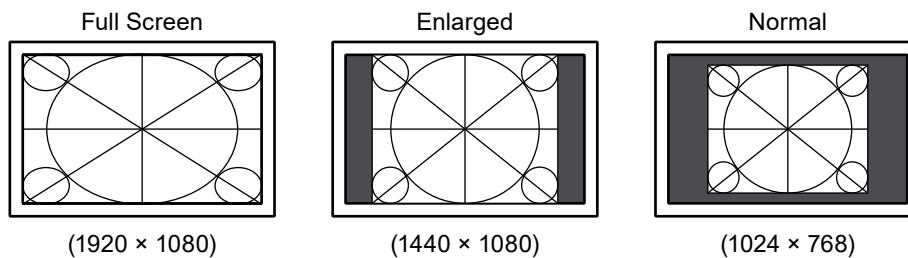

● Smoothing

When an image is enlarged with a resolution other than recommended ("Full Screen" or "Enlarged" is selected in "Screen Size"), the characters or lines of the displayed image may blur. This function reduces this blurring effect.

Adjustable range

1 to 5

Note

- Smoothing setting may not be required depending on the display resolution. (You cannot choose "Smoothing".)

● Analog Adjustment

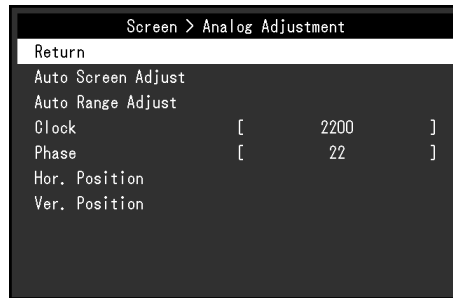

Screen flickering, display position, and size can be adjusted when the D-Sub signal is input.

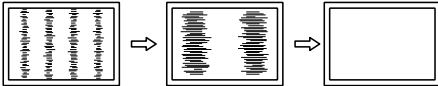
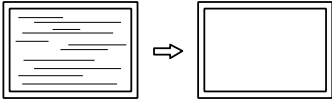
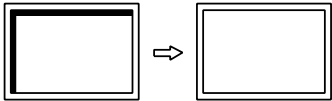
Function	Description
Auto Screen Adjust	<p>Screen flickering, display position, and size can be adjusted automatically. Selecting “Auto Screen Adjust” displays a message. Select “Yes” to enable this function.</p> <p>Note</p> <ul style="list-style-type: none"> The automatic screen adjustment function works correctly when an image is fully displayed over the entire displayable area of the screen. They do not work properly in the below cases: <ul style="list-style-type: none"> When an image is displayed only on a part of the screen (command prompt window, for example) When a black background (wallpaper, etc.) is in use Also, these functions cannot work properly in some graphic boards. When a signal is input into the monitor for the first time or when a resolution or vertical / horizontal scan frequency not used before is set, the screen is adjusted automatically (only for signals with a resolution of 800 × 600 or higher).
Auto Range Adjust	<p>Every color gradation (0 to 255) can be displayed by automatically adjusting the signal output level. Selecting “Auto Range Adjust” displays a message. Select “Yes” to enable this function.</p>
Clock	<p>Flickering of vertical lines on the screen or part of the screen can be reduced.</p>  <p>Note</p> <ul style="list-style-type: none"> Use ▲▼ to make fine adjustments so as not to miss any adjustment points.
Phase	<p>Flickering and blurring over the entire screen can be reduced.</p>  <p>Note</p> <ul style="list-style-type: none"> Flickering or blurring may not be eliminated depending on your PC or graphics board. After setting, adjust the “Clock” again if vertical bars appear.
Hor. Position Ver. Position	<p>The display position (horizontal and vertical) of the screen can be adjusted.</p>  <p>Note</p> <ul style="list-style-type: none"> Since the number of pixels and the pixel positions are fixed on the LCD monitor, only one position is provided to display images correctly. The position adjustment is made to shift an image to the correct position.

4-4. Sound

● Source



This function allows you to switch sound source during DisplayPort signal input.

Settings	Function
Stereo Mini Jack	Sets the voice connected to the analog voice input connector to the source.
DisplayPort	Sets the voice sent with the video signal through the DisplayPort cable to the source.

Note

- This setting is fixed to "Stereo Mini Jack" when the DVI signal or D-Sub signal is input.
-

4-5. PowerManager

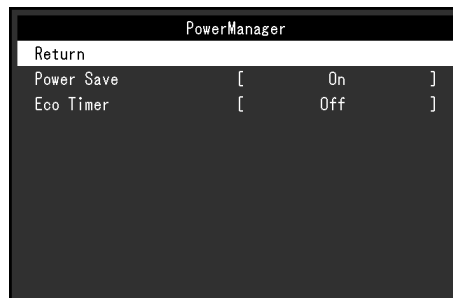

● Power Save

This function allows you to set the monitor into the power saving mode according to the PC status. When the monitor has shifted to the power saving mode, the images on the screen are not displayed.

Settings	Function
On	The monitor shifts to the power saving mode synchronously with the state of the PC.
Off	The monitor does not shift to the power saving mode regardless of the status of the PC or signal input.

Note

- When not using the monitor, you can turn off the main power supply or disconnect the power plug so that the power is cut completely.
- The monitor changes to the power saving mode about 15 seconds after the signal input ceases to be detected.
- When the monitor is in power saving mode, devices connected to the touch panel and USB downstream port will still work.
- Power consumption varies even when the stereo mini jack cable is connected.

● Eco Timer

This function allows you to switch the setting to turn off the monitor automatically after a specified time has passed in the power saving mode.

Adjustable range

Off / 0 / 1 / 2 / 3 / 5 / 10 / 15 / 20 / 25 / 30 / 45 min. / 1 / 2 / 3 / 4 / 5h

4-6. Monitor Settings

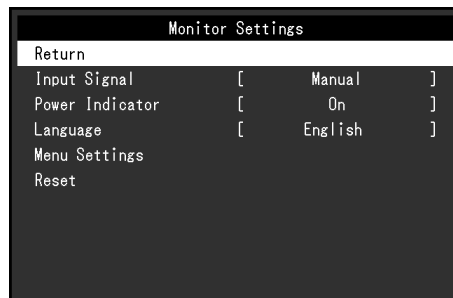

● Input Signal

Settings	Function
Auto	The monitor automatically recognizes the connector through which signals are input, and displays the screen. When a PC is turned off or enters the power saving mode, the monitor automatically displays another signal.
Manual	The monitor displays the signal from the selected connector regardless of whether a signal is input or not. Select the input signal you want to display using the operation button  .

Note

- If you select "Auto", the monitor enters the power saving mode after all the PCs have entered the power saving mode or have been switched off.

● Power Indicator

This function allows you to set the power indicator (blue) ON / OFF in the monitor ON condition.

Settings	Function
On	Turns on the power indicator.
Off	Keeps turning off the power indicator even when the screen is displayed.

● Languages

This function allows you to select a language for the Setting menu or messages.

Selectable languages

English / Deutsch / Français / Español / Italiano / Svenska / Japanese / Simplified Chinese / Traditional Chinese

● Menu Settings



Function	Adjustable range	Description
Logo	On / Off	When the monitor is turned on, the EIZO logo appears on the screen. When this function is set to "Off", the EIZO logo does not appear.
Menu Position	Center / Upper Right / Lower Right / Lower Left / Upper Left	You can change the display position of the Setting menu.

● Reset

Restore all settings to their default values, excluding the setting to enable or disable the touch panel.

Note

- For details on default settings, see ["Main Default Settings" \(page 36\)](#).

4-7. Information

Monitor information (product name, serial number, usage time, resolution, and input signal) can be checked.

Example:



4-8. Locking Operation Buttons

This function allows you to lock the settings to prevent them being changed.

Procedure





1. Press to turn the monitor off.
2. While holding down , press to turn the monitor on.
The Lock / Unlock setting is toggled by performing the operation in step 2.

Note

- The following operations are available even if the buttons are locked:
 - Turning on or off the monitor with the Power button

Chapter 5 Troubleshooting

5-1. No Picture



Problem	Possible cause and remedy
1. No picture <ul style="list-style-type: none"> Power indicator does not light. 	<ul style="list-style-type: none"> Check whether the power cord is connected properly. Turn the main power switch on. Press . Turn off the main power, and then turn it on again a few minutes later.
<ul style="list-style-type: none"> Power indicator is lighting blue. 	<ul style="list-style-type: none"> Increase "Brightness", "Contrast", or "Gain" in the Setting menu (see "4-2. Color" (page 16)).
<ul style="list-style-type: none"> Power indicator is lighting orange. 	<ul style="list-style-type: none"> Switch the input signal using . Move the mouse or press any key on the keyboard. Touch the panel surface. Check whether the PC is turned on. Depending on the PC and graphics board, the input signal is not detected and the monitor does not recover from the power saving mode. If the screen is not displayed even after moving the mouse or pressing any key on the keyboard, turn the monitor off and on using its power button. When the screen is displayed, execute the following procedure. The problem may be improved. <ol style="list-style-type: none"> Press  to turn off the monitor. While holding down , press  to turn on the monitor. "x" is displayed on the menu title of "Information" of the Setting menu (see "4-7. Information" (page 24)). <div data-bbox="799 1178 1273 1473" data-label="Image"> <p>The image shows a dark screen with white text. At the top, it says 'Information (DVI)'. Below that, there are several lines of text: '***** S/N: *****', 'Usage Time (h) 0', and 'Input Signal *****'. At the bottom, there are three lines: 'fH: *. *kHz', 'fV: *. * Hz', and 'fD:***. *MHz'. In the top right corner, there is a small white 'x' inside a dark square, which is circled in red.</p> </div> Reboot the PC. To return to the previous setting, perform steps 1 to 3 again.
<ul style="list-style-type: none"> Power indicator is flashing orange. 	<ul style="list-style-type: none"> This problem may occur when a PC is connected via the DisplayPort connector. Connect via the signal cable specified by EIZO, turn off the monitor, and then turn it on again.

Problem	Possible cause and remedy
<p>2. The message below appears.</p> <p>Example:</p> 	<p>This message appears when the signal is not input correctly even when the monitor functions properly.</p> <ul style="list-style-type: none"> • The message shown left may appear, because some PCs do not output the signal immediately after power-on. • Check whether the PC is turned on. • Check whether the signal cable is connected properly. • Switch the input signal. • Turn off the main power on the rear side of the monitor, and then turn it on again. • Check whether the PC is configured to meet the resolution and vertical scan frequency requirements of the monitor (see “Compatible Resolutions” (page 35)). • Reboot the PC. • Select an appropriate setting using the graphics board's utility. For more information, refer to the User's Manual of the graphics board.





5-2. Imaging Problems (for both digital and analog)

Problem	Possible cause and remedy
1. The screen is too bright or too dark.	<ul style="list-style-type: none"> • Use “Brightness” or “Contrast” in the Setting menu to adjust it. (The LCD monitor backlight has a limited life span. If the screen becomes dark or begins to flicker, consult your local EIZO representative.)
2. Characters are blurred.	<ul style="list-style-type: none"> • Check whether the PC is configured to meet the resolution and vertical scan frequency requirements of the monitor (see “Compatible Resolutions” (page 35)). • When an image is displayed with a resolution other than recommended, the characters or lines of the displayed image may blur. Use “Smoothing” and “Screen Size” in the Setting menu to adjust the display (see “Smoothing” (page 19) and “Screen Size” (page 19)).
3. Afterimages appear.	<ul style="list-style-type: none"> • Afterimages are particular to LCD monitors. Avoid displaying the same image for a long time. • Use the screen saver or power save function to avoid displaying the same image for extended periods of time.
4. Green / red / blue / white dots or defective dots remain on the screen.	<ul style="list-style-type: none"> • This is due to LCD panel characteristics and is not a failure.
5. Interference patterns or pressure marks remain on the screen.	<ul style="list-style-type: none"> • Display a white or black image over the entire screen. The symptom may disappear.
6. Noise appears on the screen.	<ul style="list-style-type: none"> • In the Setting menu, set “Overdrive” to “Off” (see “Overdrive” (page 18)). • When entering the HDCP signals, the normal images may not be displayed immediately.

5-3. Imaging Problems (for analog only)





Problem	Possible cause and remedy
<p>1. Display position is incorrect.</p> 	<ul style="list-style-type: none"> Use "Menu Position" in the Setting menu to correct the image position (see "Hor. Position" (page 20)). If the problem persists, use the graphics board's utility if available to change the display position.
<p>2. Vertical bars appear on the screen or a part of the image is flickering.</p> 	<ul style="list-style-type: none"> Use "Clock" in the Setting menu to adjust it (see "Clock" (page 20)).
<p>3. Whole screen is flickering or blurring.</p> 	<ul style="list-style-type: none"> Use "Phase" in the Setting menu to adjust it (see "Phase" (page 20)).

5-4. Imaging Problems (for digital only)

Problem	Possible cause and remedy									
<p>1. (During DisplayPort signal input) Turning the power off/on or exiting power saving mode will move the windows and icons. In a multi-monitor environment, switching off the power of one monitor will switch the screen settings to a single-monitor display.</p>	<ul style="list-style-type: none"> In the following step, set the "DP Power Save" function to "Off". Setting the function to "Off" may increase power consumption. <ol style="list-style-type: none"> Press  to turn off the monitor. Hold down  /  while pressing  to turn on the monitor. The function will switch between "Off" and "On" each time the operation is executed. The current setting status can be identified based on the color used to display the input port or signal error. <table border="1" data-bbox="737 1404 1361 1626"> <thead> <tr> <th>Setting</th> <th>Input port</th> <th>Signal Error</th> </tr> </thead> <tbody> <tr> <td>On (default setting)</td> <td>DisplayPort</td> <td>DisplayPort Signal Error</td> </tr> <tr> <td>Off</td> <td>DisplayPort</td> <td>DisplayPort Signal Error</td> </tr> </tbody> </table> 	Setting	Input port	Signal Error	On (default setting)	DisplayPort	DisplayPort Signal Error	Off	DisplayPort	DisplayPort Signal Error
Setting	Input port	Signal Error								
On (default setting)	DisplayPort	DisplayPort Signal Error								
Off	DisplayPort	DisplayPort Signal Error								

5-5. Touch Panel Problems

When you are using the dedicated touch panel driver (included on the CD-ROM), also see the touch panel driver User's Manual (included on the CD-ROM).

Problem	Possible cause and remedy
<p>1. Touch operation is disabled.</p>	<ul style="list-style-type: none"> • Check that the monitor and PC are connected with a USB cable. • Press . • Check that the power cord of the monitor and PC is connected to a grounded main outlet. Failure to ground the equipment may result in malfunction. • Hold down  (see “2-1. Enabling or Disabling the Touch Panel” (page 10)). • Perform touch panel sensitivity adjustment using TPOffset.
<p>2. Cursor position is not correct. / Cursor jumps.</p>	<ul style="list-style-type: none"> • Connect the monitor to the PC with the cable indicated in the Setup Guide. The touch panel may not work correctly if a conversion adapter is used. • Turn off and on the monitor. • Adjust the touch position. <ul style="list-style-type: none"> - When you are using the dedicated touch panel driver, see the touch panel driver User's Manual. - When you are using the Windows standard driver, configure settings, see “3-2. Adjusting the Touch Position” (page 12). • Check that the power cord of the monitor and PC is connected to a grounded main outlet. Failure to ground the equipment may result in malfunction. • Hold down  (see “2-1. Enabling or Disabling the Touch Panel” (page 10)). • Changing the position or angle of the monitor may cause the cursor to jump. • Keep metals away from the panel surface. • If the touch panel is dirty, the touch panel may not operate properly. Clean the touch panel (see “Cleaning” (page 4)). • The spray for preventing static electricity may influence the sensitivity of the touch panel. • Do not touch the touch panel for 5 seconds after the PC starts up, after turning on the monitor, or after connecting the USB cable. Touching the touch panel too soon may cause incorrect cursor positioning or disable touch operation. If this occurs, either leave the touch panel untouched for approximately 2 minutes or turn the monitor off and on again. If the error recurs, hold down . • Perform touch panel sensitivity adjustment using TPOffset. • Changing the screen size of the monitor may cause the cursor position to become misaligned. When the screen size is changed, adjust the touch position.
<p>3. The cursor does not appear at the touched position and instead is displayed at a point-symmetric position with respect to the center of the screen.</p>	<ul style="list-style-type: none"> • Adjust the touch position. <ul style="list-style-type: none"> - When you are using the dedicated touch panel driver, see the touch panel driver User's Manual. - When you are using the Windows standard driver, configure settings, see “3-2. Adjusting the Touch Position” (page 12).

Problem	Possible cause and remedy
<p>4. Cursor is jittery. / Drawing lines are not straight and smooth.</p>	<ul style="list-style-type: none"> • Check that the power cord of the monitor and PC is connected to a grounded main outlet. Failure to ground the equipment may result in malfunction. • Perform touch panel sensitivity adjustment using TPOffset. • The influence of metal may cause jittery cursor. • When multiple monitors are placed close to each other, leave space between monitors.
<p>5. The touch position is not set as adjusted.</p>	<ul style="list-style-type: none"> • When you are using the dedicated touch panel driver, see the touch panel driver User's Manual. • Reset the touch panel to the state before calibration (by clicking "Reset" in the "Display" tab of the "Tablet PC Settings" window accessible from the Windows Control Panel), and then adjust the touch position (see "3-2. Adjusting the Touch Position" (page 12)). • Once "Setup" has been completed in the "Display" tab of the "Tablet PC Settings" window accessible from the Windows Control Panel, close the "Tablet PC Settings" once, open the "Display" tab of "Tablet PC Settings" again, and then adjust the touch position.
<p>6. No touch sound is output.</p>	<ul style="list-style-type: none"> • When you are using the Windows standard driver, touch sound is not output. When you want to output touch sound, use the dedicated touch panel driver (see "3-1. Touch Panel Setting Method" (page 12)). • When no touch sound is output while you are using the dedicated touch panel driver, see the touch panel driver User's Manual.
<p>7. The multi-touch function does not run.</p>	<ul style="list-style-type: none"> • Reboot the PC. • When you are using the dedicated touch panel driver, see the touch panel driver User's Manual.

Attention

- For details on TPOffset (software for adjusting touch panel sensitivity), see the TPOffset User's Manual (on the CD-ROM).

5-6. Other Problems

Problem	Possible cause and remedy
1. The Setting menu does not appear.	<ul style="list-style-type: none"> • Check whether the operation lock function is active (see “4-8. Locking Operation Buttons” (page 24)).
2. The “Smoothing” on the Setting menu “Screen” cannot be selected.	<ul style="list-style-type: none"> • You cannot choose “smoothing” when the screen is displayed in the following resolutions or settings. <ul style="list-style-type: none"> - The resolution is 1920 × 1080 - Screen Size is “Normal”
3. The auto adjustment function does not work.	<ul style="list-style-type: none"> • This function does not work during digital signal input. • This function works correctly when an image is displayed over the entire displayable area of the Windows screen, etc. It does not work properly when an image is displayed only on a part of the screen (command prompt window, for example) or when a black background (wallpaper, etc.) is in use. • This function does not work correctly with some graphics boards.
4. No audio output.	<ul style="list-style-type: none"> • Check whether the stereo mini jack cable is connected properly. • Check whether volume is set to 0. • Check the setting of the PC and the audio playback software. • During DisplayPort signal input, check the “Source” setting (see “Source” (page 21)).
5. USB devices connected to the monitor does not work.	<ul style="list-style-type: none"> • Check whether the USB cable is connected correctly. • Change the USB port to another one. If the PC or peripheral devices works correctly by changing the USB port, consult your local EIZO representative (see the manual of the PC for details). • Reboot the PC. • If the peripheral devices work correctly when they are directly connected to the PC, consult your local EIZO representative. • Check whether the PC and OS are USB compliant.(For USB compliance of the respective devices, consult their manufacturers.) • Check the PC’s BIOS setting for USB when using Windows. (Refer to the manual of the PC for details.)

Chapter 6 Reference

6-1. Attaching the Optional Arm

An optional arm (or an optional stand) can be attached by removing the stand section.

Attention

- When attaching an arm or stand, follow the instructions of their User's Manual.
- Connect the cables after attaching an arm or stand.
- Do not move the removed stand up and down. Doing so may result in injury or device damage.
- The monitor and arm or stand are heavy. Dropping them may result in injury or equipment damage.

Installation Requirements

When using another manufacturer's arm or stand, confirm the following in advance and select one conforming to the VESA standard.

- Clearance between the screw holes: 100 mm × 100 mm
- Thickness of plate: 2.6 mm
- Strong enough to support weight of the monitor unit (except the stand) and attachments such as cables.

When using another manufacturer's arm or stand, use the screws as described below.

- Screws fixing the stand to the monitor

When attaching an arm or stand, installation conditions are as follows:

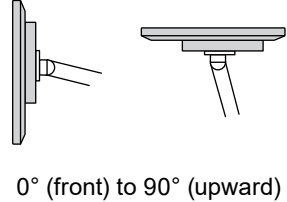
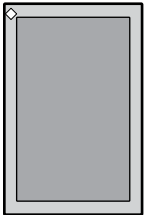
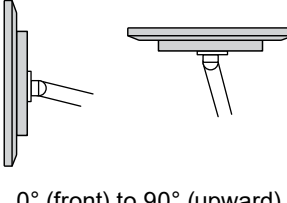
	Orientation	Display direction
Landscape		 0° (front) to 90° (upward)
Portrait		 0° (front) to 90° (upward)

Procedure

1. Lay the LCD monitor on a soft cloth spread over a stable surface with the panel surface facing down.

2. Remove the stand.

Using a screwdriver, loosen the screws securing the unit and the stand.

3. Attach the arm or stand to the monitor.

Secure the monitor to the arm or stand using the screws specified in the User's Manual of the arm or stand.

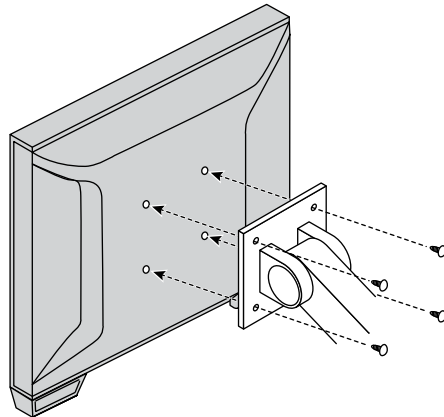

Note

- When setting the monitor in the portrait orientation, remove the feet on the bottom of the monitor according to the following procedure.
- Store the removed parts in a safe place.

1. Remove the foot covers.

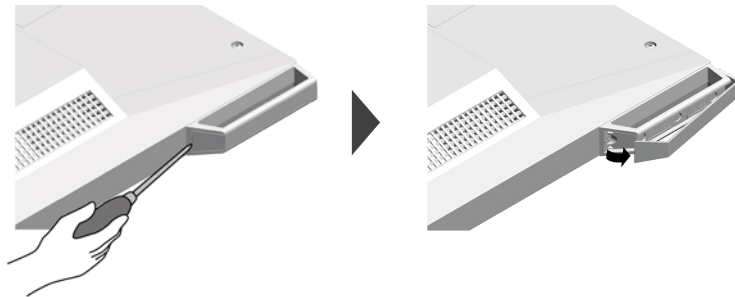

2. Remove the screw that secures each foot to the monitor.

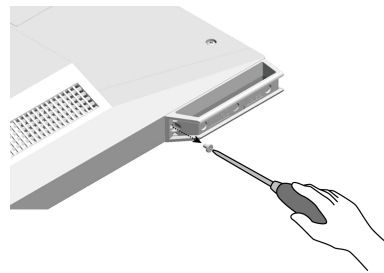

3. Slide each foot toward the edge of the monitor and remove them as shown below.

To cover the hole, adhere the seal supplied with this product.



6-2. Connecting Multiple PCs

The product has multiple connections to PCs and allows you to switch to one of the connections for display.

Connection examples

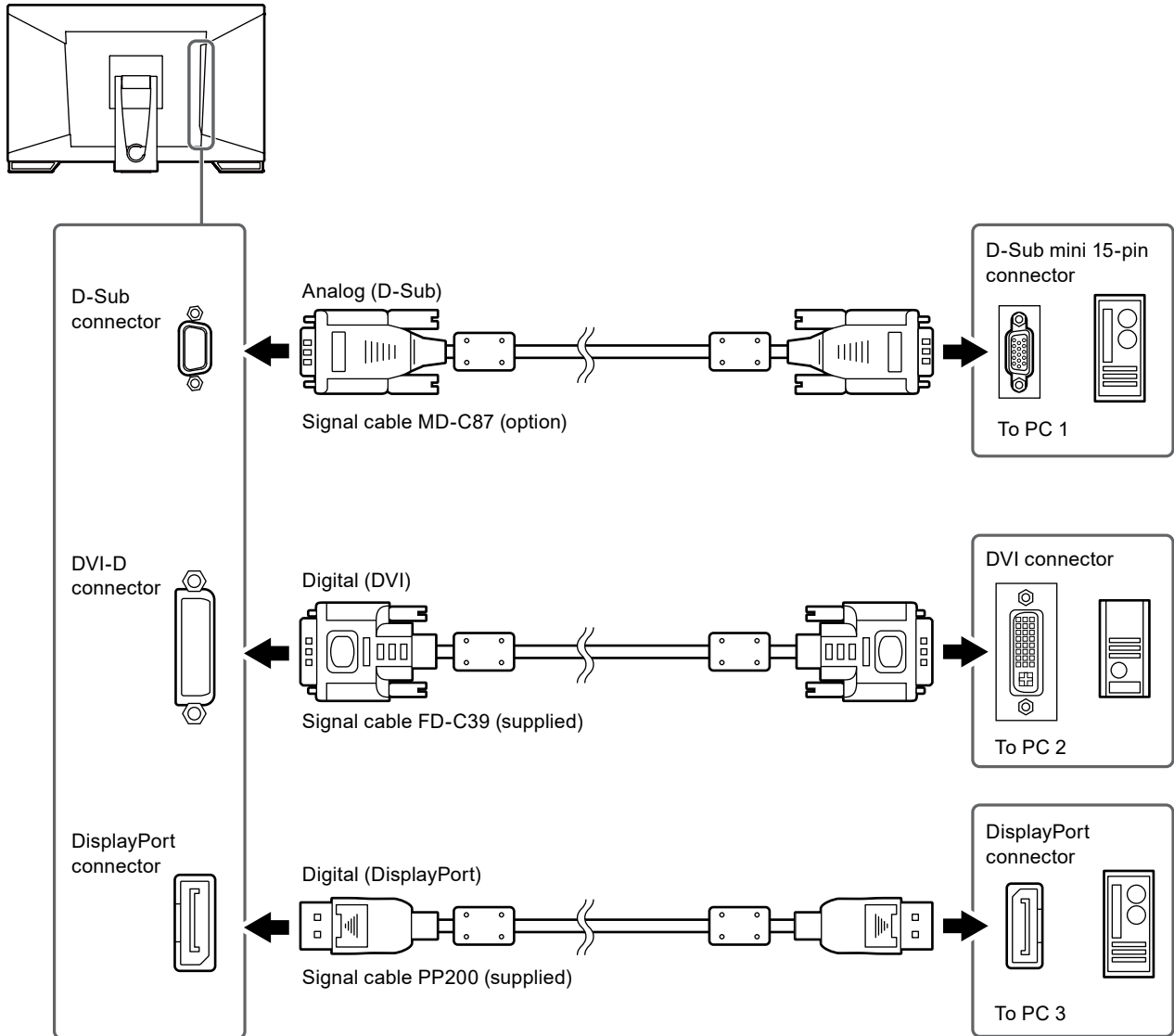

Attention

- The touch panel only works on the USB-connected monitor.

6-3. Specifications

LCD Panel	Type	IPS			
	Backlight	LED			
	Size	58.4 cm (23.0 inch)			
	Resolution	1920 dots × 1080 lines			
	Display Size	509.2 mm × 286.4 mm (H × V)			
	Pixel Pitch	0.265 mm			
	Display Colors	8-bit color: 16.77 million colors			
	Viewing Angles	178° / 178° (H / V, typical)			
Response Time	Gray-to-gray: Approx. 6 ms (Overdrive setting: Enhanced, typical)				
Touch Panel	Surface treatment	Anti-glare			
	Surface hardness	5 H			
	Communication	USB-based			
	Detection method	Projected capacitive technology			
	OS	Microsoft Windows 10 (32 bit / 64 bit) Microsoft Windows 8.1 (32 bit / 64 bit) Microsoft Windows 7 (32 bit / 64 bit)			
	Number of simultaneous touch points	Max. 10 points			
Video Signals	Input Terminals	Digital	DisplayPort × 1, DVI-D × 1 (compatible with HDCP)		
		Analog	D-Sub mini 15-pin		
	Digital Scanning Frequency	Horizontal	DisplayPort	31 kHz to 68 kHz	
			DVI	31 kHz to 64 kHz	
		Vertical	59 Hz to 61 Hz (720 × 400 : 69 Hz to 71 Hz)		
	Analog Scanning Frequency	Horizontal	31 kHz to 81 kHz		
		Vertical	55 Hz to 76 Hz		
	Frame Synchronization mode	59 Hz to 61 Hz			
Dot Clock (Max.)	Digital	148.5 MHz			
	Analog	148.5 MHz			
USB	Port	Upstream port x 1			
		Downstream port x 2			
	Standard	USB Specification Revision 2.0			
	Communication Speed	480 Mbps (high) / 12 Mbps (full) / 1.5 Mbps (low)			
Supply current	Downstream port : Max. 500 mA / 1 port				
Audio	Input	Terminal	Stereo mini jack × 1 DisplayPort × 1 (shared with video signal) - Format: 2ch linear PCM (32 kHz / 44.1 kHz / 48 kHz / 88.2 kHz / 96 kHz)		
		Output	Terminal	Stereo mini jack × 1 (for headphone)	
	Speaker	1.0 W + 1.0 W			
	Headphones	2.0 mW + 2.0 mW			
Power supply	Input	100 - 240 VAC ±10%, 50 Hz / 60 Hz, 0.65 A - 0.35 A			
	Power Consumption	Max.	42 W or less		
		Power Save Mode	0.7 W or less	D-Sub input only connected, USB non-connection, audio cable non-connection, "Monitor Settings" - "Input Signal": "Auto"	
		Standby Mode	0.7 W or less	D-Sub input only connected, USB non-connection, audio cable non-connection	

Physical Specifications	Outside dimensions (Width × Height × Depth)	Entire product	Min. height	556.7 mm × 143.9 mm × 401.3 mm (Tilt: 70°)
			Max. height	556.7 mm × 353.9 mm × 216.3 mm (Tilt: 15°)
		Monitor Section		556.7 mm × 339.2 mm × 54 mm
	Weight	Entire product		6.6 kg
		Monitor Section		6.0 kg
Tilt	15° to 70°			
Environmental Conditions	Available Range	Temperature	5 °C to 35 °C	
		Humidity	20 % to 80 % R.H. (no condensation)	
		Air Pressure	540 hPa to 1060 hPa	
	Transportation / Storage Range	Temperature	-20 °C to 60 °C	
		Humidity	10 % to 92 % R.H. (no condensation)	
		Air Pressure	200 hPa to 1060 hPa	

● Compatible Resolutions

Analog Input (D-Sub)

Resolution	Vertical scan frequency
640 × 480	60 Hz to 75 Hz
720 × 400	70 Hz
800 × 600	56 Hz to 75 Hz
1024 × 768	60 Hz to 75 Hz
1280 × 720	60 Hz
1280 × 960	60 Hz
1280 × 1024	60 Hz to 75 Hz
1680 × 1050	60 Hz
1920 × 1080 ^{*1}	60 Hz

*1 Recommended resolution

Digital Signal (DisplayPort / DVI-D) Input

Resolution	Vertical scan frequency	DisplayPort	DVI-D
640 × 480	60 Hz	√	√
720 × 400	70 Hz	√	√
720 × 480	60 Hz	√	-
800 × 600	60 Hz	√	√
1024 × 768	60 Hz	√	√
1280 × 720	60 Hz	√	√
1280 × 960	60 Hz	√	√
1280 × 1024	60 Hz	√	√
1680 × 1050	60 Hz	√	√
1920 × 1080 ^{*1}	60 Hz	√	√

*1 Recommended resolution

● Main Default Settings

Touchpanel	Enable
Color Mode	User1
Screen Size	Full Screen
Smoothing	3
Power Save	On
Eco Timer	Off
Language	English
Menu Position	Center
Input Signal	Auto

● Accessories

Touch pen	TP5
-----------	-----

For the latest information about the accessories, see our web site.

www.eizoglobal.com

Appendix

Trademark

The terms HDMI and HDMI High-Definition Multimedia Interface, and the HDMI Logo are trademarks or registered trademarks of HDMI Licensing, LLC in the United States and other countries.

The DisplayPort Compliance Logo and VESA are registered trademarks of the Video Electronics Standards Association.

The SuperSpeed USB Trident Logo is a registered trademark of USB Implementers Forum, Inc.



DICOM is the registered trademark of the National Electrical Manufacturers Association for its standards publications relating to digital communications of medical information.

Kensington and Microsaver are registered trademarks of ACCO Brands Corporation.

Thunderbolt is a trademark of Intel Corporation in the United States and/or other countries.

Microsoft and Windows are registered trademarks of Microsoft Corporation in the United States and other countries.

Adobe is a registered trademark of Adobe Systems Incorporated in the United States and other countries.

Apple, macOS, Mac OS, OS X, Macintosh and ColorSync are registered trademarks of Apple Inc.

EIZO, the EIZO Logo, ColorEdge, CuratOR, DuraVision, FlexScan, FORIS, RadiCS, RadiForce, RadiNET, Raptor and ScreenManager are registered trademarks of EIZO Corporation in Japan and other countries.

ColorEdge Tablet Controller, ColorNavigator, EcoView NET, EIZO EasyPIX, EIZO Monitor Configurator, EIZO ScreenSlicer, G-Ignition, i •Sound, Quick Color Match, RadiLight, Re/Vue, Screen Administrator, Screen InStyle and UniColor Pro are trademarks of EIZO Corporation.

All other company and product names are trademarks or registered trademarks of their respective owners.

License

The bitmap font used for this product is designed by Ricoh Industrial Solutions Inc.

FCC Declaration of Conformity

For U.S.A., Canada Only

FCC Declaration of Conformity

We, the Responsible Party

EIZO Inc.

5710 Warland Drive, Cypress, CA 90630

Phone: (562) 431-5011

declare that the product

Trade name: EIZO

Model: DuraVision FDF2382WT

is in conformity with Part 15 of the FCC Rules. Operation of this product is subject to the following two conditions: (1) this device may not cause harmful interference, and (2) this device must accept any interference received, including interference that may cause undesired operation.

This equipment has been tested and found to comply with the limits for a Class B digital device, pursuant to Part 15 of the FCC Rules. These limits are designed to provide reasonable protection against harmful interference in a residential installation. This equipment generates, uses, and can radiate radio frequency energy and, if not installed and used in accordance with the instructions, may cause harmful interference to radio communications. However, there is no guarantee that interference will not occur in a particular installation. If this equipment does cause harmful interference to radio or television reception, which can be determined by turning the equipment off and on, the user is encouraged to try to correct the interference by one or more of the following measures.

- * Reorient or relocate the receiving antenna.
- * Increase the separation between the equipment and receiver.
- * Connect the equipment into an outlet on a circuit different from that to which the receiver is connected.
- * Consult the dealer or an experienced radio/TV technician for help.

Changes or modifications not expressly approved by the party responsible for compliance could void the user's authority to operate the equipment.

Note

Use the attached specified cable below or EIZO signal cable with this monitor so as to keep interference within the limits of a Class B digital device.

- AC Cord
- Shielded Signal Cable (enclosed)

Canadian Notice

This Class B information technology equipment complies with Canadian ICES-003.
Cet équipement informatique de classe B est conforme à la norme NMB-003 du Canada.

LIMITED WARRANTY

EIZO Corporation (hereinafter referred to as “EIZO”) and distributors authorized by EIZO (hereinafter referred to as the “Distributors”) warrant, subject to and in accordance with the terms of this limited warranty (hereinafter referred to as the “Warranty”), to the original purchaser (hereinafter referred to as the “Original Purchaser”) who purchased the product specified in this document (hereinafter referred to as the “Product”) from EIZO or Distributors, that EIZO and Distributors shall, at their sole discretion, either repair or replace the Product at no charge if the Original Purchaser becomes aware within the Warranty Period (defined below) that the Product malfunctions or is damaged in the course of normal use of the Product in accordance with the description in the instruction manual attached to the Product (hereinafter referred to as the “User’s Manual”).

The period of this Warranty is three (3) years from the date of purchase of the Product (hereinafter referred to as the “Warranty Period”). EIZO and Distributors shall bear no liability or obligation with regard to the Product in relation to the Original Purchaser or any third parties other than as provided under this Warranty.

EIZO and Distributors will cease to hold or store any parts (excluding design parts) of the Product upon expiration of seven (7) years after the production of the Product is discontinued. In repairing the monitor, EIZO and Distributors will use renewal parts which comply with our QC standards. If the unit cannot be repaired due to its condition or the stockout of a relevant part, EIZO and Distributors may offer the replacement by a product with equivalent performance instead of repairing it.

The Warranty is valid only in the countries or territories where the Distributors are located. The Warranty does not restrict any legal rights of the Original Purchaser.

Notwithstanding any other provision of this Warranty, EIZO and Distributors shall have no obligation under this Warranty whatsoever in any of the cases as set forth below:

- (a) Any defect of the Product caused by freight damage, modification, alteration, abuse, misuse, accident, incorrect installation, disaster, faulty maintenance and/or improper repair by third party other than EIZO and Distributors;
- (b) Any incompatibility of the Product due to possible technical innovations and/or regulations;
- (c) Any deterioration of the sensor;
- (d) Any defect of the Product caused by external equipment;
- (e) Any defect of the Product on which the original serial number has been altered or removed;
- (f) Any normal deterioration of the product, particularly that of consumables, accessories, and/or attachments (e.g. buttons, rotating parts, cables, User’s Manual, etc.);
- (g) Any deformation, discoloration, and/or warp of the exterior of the product including that of the surface of the LCD panel;
- (h) Any defect of the Product caused by placement in a location where it may be affected by strong vibration or shocks;
- (i) Any defect of the Product caused by liquid leaking from battery; and
- (j) Any deterioration of display performance caused by the deterioration of expendable parts such as the LCD panel and/or backlight, etc. (e.g. changes in brightness, changes in brightness uniformity, changes in color, changes in color uniformity, defects in pixels including burnt pixels, etc.).

To obtain service under the Warranty, the Original Purchaser must deliver the Product, freight prepaid, in its original package or other adequate package affording an equal degree of protection, assuming the risk of damage and/or loss in transit, to the local Distributor. The Original Purchaser must present proof of purchase of the Product and the date of such purchase when requesting services under the Warranty.

The Warranty Period for any replaced and/or repaired product under this Warranty shall expire at the end of the original Warranty Period.

EIZO OR DISTRIBUTORS ARE NOT RESPONSIBLE FOR ANY DAMAGE TO, OR LOSS OF, DATA OR OTHER INFORMATION STORED IN ANY MEDIA OR ANY PART OF ANY PRODUCT RETURNED TO EIZO OR DISTRIBUTORS FOR REPAIR.

EIZO AND DISTRIBUTORS MAKE NO FURTHER WARRANTIES, EXPRESSED OR IMPLIED, WITH RESPECT TO THE PRODUCT AND ITS QUALITY, PERFORMANCE, MERCHANTABILITY OR FITNESS FOR ANY PARTICULAR USE. IN NO EVENT SHALL EIZO OR DISTRIBUTORS BE LIABLE FOR ANY INCIDENTAL, INDIRECT, SPECIAL, CONSEQUENTIAL OR OTHER DAMAGE WHATSOEVER (INCLUDING, WITHOUT LIMITATION, DAMAGES FOR LOSS OF PROFIT, BUSINESS INTERRUPTION, LOSS OF BUSINESS INFORMATION, OR ANY OTHER PECUNIARY LOSS) ARISING OUT OF THE USE OR INABILITY TO USE THE PRODUCT OR IN ANY CONNECTION WITH THE PRODUCT, WHETHER BASED ON CONTRACT, TORT, NEGLIGENCE, STRICT LIABILITY OR OTHERWISE, EVEN IF EIZO OR DISTRIBUTORS HAVE BEEN ADVISED OF THE POSSIBILITY OF SUCH DAMAGES. THIS EXCLUSION ALSO INCLUDES ANY LIABILITY WHICH MAY ARISE OUT OF THIRD PARTY CLAIMS AGAINST THE ORIGINAL PURCHASER. THE ESSENCE OF THIS PROVISION IS TO LIMIT THE POTENTIAL LIABILITY OF EIZO AND DISTRIBUTORS ARISING OUT OF THIS LIMITED WARRANTY AND/OR SALES.

Recycling Information

Recycling Information

This product, when disposed of, is supposed to be collected and recycled according to your country's legislation to reduce environmental burden. When you dispose of this product, please contact a distributor or an affiliate in your country.

The contact addressees are listed on the EIZO website below.

www.eizoglobal.com

For recycling information for customers in Switzerland, please refer to the following website.

www.swico.ch

Informationen zum Thema Recycling

Dieses Produkt muss gemäß den Vorschriften Ihres Landes zur Entlastung der Umwelt recyclet werden. Wenden Sie sich bei der Entsorgung dieses Produkts an einen Verteiler oder eine Tochtergesellschaft in Ihrem Land.

Die Adressen zur Kontaktaufnahme sind auf der unten angegebenen Website von EIZO aufgeführt.

www.eizoglobal.com

Kunden in der Schweiz entnehmen Informationen zum Recycling der folgenden Website:

www.swico.ch

Informations sur le recyclage

Ce produit doit être jeté aux points de collecte prévus à cet effet et recyclé conformément à la législation de votre pays, afin de réduire l'impact sur l'environnement. Lorsque vous jetez ce produit, veuillez contacter un distributeur ou une société affiliée de votre pays.

Les adresses des distributeurs sont répertoriées sur le site Web EIZO ci-dessous.

www.eizoglobal.com

Pour les clients en Suisse, veuillez consulter le site Web suivant afin d'obtenir des informations sur le recyclage.

www.swico.ch

Información sobre reciclaje

Este producto debe desecharse y reciclarse según la legislación del país para reducir el impacto medioambiental.

Cuando desee deshacerse de este producto, póngase en contacto con un distribuidor o una filial de su país.

Encontrará las direcciones de contacto en el sitio web de EIZO que se indica a continuación.

www.eizoglobal.com

Informazioni sul riciclaggio

Per lo smaltimento e il riciclaggio del presente prodotto, attenersi alle normative vigenti nel proprio paese per ridurre l'impatto ambientale. Per lo smaltimento, rivolgersi ad un distributore o un affiliato presenti nel proprio paese.

Gli indirizzi sono elencati nel sito Web EIZO riportato di seguito.

www.eizoglobal.com

Per informazioni sul riciclaggio per i clienti in Svizzera, consultare il sito Web riportato di seguito.

www.swico.ch

Återvinningsinformation

När denna produkt kasseras ska den hanteras och återvinnas enligt landets föreskrifter för att reducera miljöpåverkan.

När du kasserar produkten ska du kontakta en distributör eller representant i ditt land.

Kontaktadresserna listas på EIZO-webbplatsen nedan.

www.eizoglobal.com

Πληροφορίες ανακύκλωσης

Το προϊόν αυτό, όταν απορρίπτεται, πρέπει να συλλέγεται και να ανακυκλώνεται σύμφωνα με τη νομοθεσία της χώρας σας έτσι ώστε να μην επιβαρύνει το περιβάλλον. Για να απορρίψετε το προϊόν, επικοινωνήστε με έναν αντιπρόσωπο ή μια θυγατρική εταιρεία στη χώρα σας.

Οι διευθύνσεις επικοινωνίας αναγράφονται στην τοποθεσία web της EIZO παρακάτω.

www.eizoglobal.com

Сведения по утилизации

По истечении срока службы данного продукта его следует принести на сборный пункт и утилизировать в соответствии с действующими предписаниями в вашей стране, чтобы уменьшить вредное воздействие на окружающую среду. Прежде чем выбросить данный продукт, обратитесь к дистрибьютору или в местное представительство компании в вашей стране.

Контактные адреса можно найти на веб-узле EIZO.

www.eizoglobal.com

Informatie over recycling

Wanneer u dit product wilt weggooien, moet het uit milieu-overwegingen worden verzameld en gerecycled volgens de betreffende wetgeving van uw land. Wanneer u dit product wilt weggooien, moet u contact opnemen met een distributeur of een partner in uw land.

De contactadressen worden vermeld op de volgende EIZO-website.

www.eizoglobal.com

Informação sobre reciclagem

Este produto, quando o deitar fora, deve ser recolhido e reciclado de acordo com a legislação do seu país para reduzir a poluição. Quando deitar fora este produto, contacte um distribuidor ou uma filial no seu país.

Os endereços de contacto estão listados no website do EIZO, abaixo.

www.eizoglobal.com

Oplysninger om genbrug

Dette produkt forventes ved bortskaffelse at blive indsamlet og genbrugt i overensstemmelse med lovgivningen i dit land for at reducere belastningen af miljøet. Når du bortskaffer denne produkt, skal du kontakte en distributør eller et tilknyttet selskab i dit land.

Adresserne på kontaktpersonerne er angivet på EIZO's websted nedenfor.

www.eizoglobal.com

Kierrätystä koskevia tietoja

Tuote tulee hävittää kierrättämällä maan lainsäädännön mukaisesti ympäristön kuormittumisen vähentämiseksi. Kun hävität tuotteen, ota yhteyttä jälleenmyyjään tai tytäryhtiöön maassasi.

Yhteystiedot löytyvät EIZOn Internet-sivustolta.

www.eizoglobal.com

Wykorzystanie surowców wtórnych

Ten produkt po zużyciu powinien być zbierany i przetwarzany zgodnie z krajowymi przepisami dotyczącymi ochrony środowiska. Wyrzucając ten produkt, należy skontaktować się z lokalnym dystrybutorem lub partnerem. Adresy kontaktowe można znaleźć we wskazanej poniżej witrynie internetowej firmy EIZO.

www.eizoglobal.com

Informace o recyklaci

Při likvidaci produktu musí být produkt vyzvednut a recyklován podle zákonů příslušné země, aby nedocházelo k zatěžování životního prostředí. Zbavujete-li se produktu, kontaktujte distributora nebo pobočku ve své zemi. Kontaktní adresy jsou uvedeny na následující webové stránce společnosti EIZO.

www.eizoglobal.com

Ringlussevõtu alane teave

Keskkonnakoormuse vähendamiseks tuleks kasutatud tooted kokku koguda ja võtta ringlusse vastavalt teie riigi seadustele. Kui kõrvaldate käesoleva toote, võtke palun ühendust turustaja või filiaaliga oma riigis.

Kontaktisikud on toodud EIZO veebilehel järgmisel aadressil:

www.eizoglobal.com

Újrahasznosítási információ

Jelen terméket, amikor eldobjuk, az illető ország törvényei alapján kell összegyűjteni és újrahasznosítani, hogy csökkentsek a környezet terhelését. Amikor ezt a terméket eldobja, kérjük lépjen kapcsolatba egy országon belüli forgalmazóval vagy társvállalkozással.

A kapcsolat címei az EIZO alábbi weboldalán található felsorolva:

www.eizoglobal.com

Podatki o recikliranju

Ob koncu uporabe odslužen izdelek izročite na zbirno mesto za recikliranje v skladu z okoljevarstveno zakonodajo vaše države. Prosimo, da se pri odstranjevanju izdelka obrnete na lokalnega distributerja ali podružnico.

Kontaktni naslovi so objavljeni na spodaj navedenih spletnih straneh EIZO:

www.eizoglobal.com

Informácie o recyklácii

Pri likvidácii musí byť tento výrobok recyklovaný v súlade s legislatívou vašej krajiny, aby sa znížilo zaťaženie životného prostredia. Keď sa chcete zbaviť tohto výrobku, kontaktujte prosím distribútora alebo pobočku vo vašej krajine.

Zoznam kontaktných adries je uvedený na nasledovnej webovej stránke firmy EIZO:

www.eizoglobal.com

Pārstrādes informācija

Utilizējot šo produktu, tā savākšana un pārstrāde veicama atbilstoši jūsu valsts likumdošanas prasībām attiecībā uz slodzes uz vidi samazināšanu. Lai veiktu šī produkta utilizāciju, sazinieties ar izplatītāju vai pārstāvniecību jūsu valstī. Kontaktadreses ir norādītas zemāk minētajā EIZO tīmekļa vietnē.

www.eizoglobal.com

Informacija apie gražinamąjį perdirbimą

Šalinant (išmetant) šiuos gaminius juos reikia surinkti ir perdirbti gražinamuoju būdu pagal jūsų šalies teisės aktus, siekiant sumažinti aplinkos teršimą. Kai reikia išmesti šį gaminį, kreipkitės į jūsų šalyje veikiančią gaminių pardavimo atstovybę arba jos filialą.

Kontaktiniai adresatai nurodyti EIZO interneto svetainėje.

www.eizoglobal.com

Информация относительно рециклиране

При изхвърлянето на този продукт се предлага събирането и рециклирането му съобразно законите на вашата страна за да се намали замърсяването на околната среда. Когато искате да се освободите от този продукт, моля свържете се с търговския му представител или със съответните органи отговарящи за това във вашата страна.

Данните за връзка с нас са описани на следния Интернет сайт на EIZO:

www.eizoglobal.com

Informație referitoare la reciclare

Acest produs, când debarasat, trebuie colectat și reciclat conform legislației țării respective ca să reducem sarcina mediului. Când se debarasează de acest produs, vă rugăm să contactați un distribuitor sau un afiliat al țării respective.

Adresele de contact le găsiți pe pagina de web al EIZO:

www.eizoglobal.com

معلومات عن اعادة التدوير

عند التخلص من هذا المنتج، من الضروري تجميعه واعادة تدويره وفقاً للقوانين المتبعة في بلدك لتقليل العبء المسلط على البيئة. عندما تتخلص من هذا المنتج، يرجى الاتصال بموزع أو طرف منتسب إليه في بلدك. عناوين الاتصال مدرجة في موقع ايزو EIZO ادناه على شبكة الانترنت.

www.eizoglobal.com

Gerı Dönüşüm Bilgisi

Bu ürünün, atılacağı zaman, ülkenizin çevre kirliliğinin azaltılması konusundaki mevzuatına göre toplanması ve yeniden değerlendirilmesi gerekmektedir. Ürünü atacağınız zaman lütfen ülkenizdeki bir distribütör veya ilgili kuruluşla temasa geçiniz.

İrtibat adresleri aşağıdaki EIZO web sitesinde verilmiştir.

www.eizoglobal.com

