

USER MANUAL

ProLite

LCD Monitor

ENGLISH

ProLite TF6537UHSC

Thank you very much for choosing the iiyama LCD monitor.

We recommend that you take a few minutes to read this comprehensive manual carefully before installing and switching on the monitor. Please keep this manual in a safe place for your future reference.

CE MARKING DECLARATION OF CONFORMITY

This LCD monitor complies with the requirements of the EC/EU Directive 2014/30/EU "EMC Directive", 2014/35/EU "Low Voltage Directive", 2009/125/EC "ErP Directive" and 2011/65/EU "RoHS Directive".

Warning

This is a class A product. In a domestic environment this product may cause radio interference in which case the user may be required to take adequate measures.

IYAMA CORPORATION: Wijkemeerstraat 8, 2131 HA Hoofddorp, The Netherlands

Model No. : PL6537



We recommend recycling of used product. Please contact your dealer or iiyama service center. Recycle information is obtained via the Internet, using the address: <http://www.iiyama.com>

You can access the Web page of different countries from there.

- We reserve the right to change specifications without notice.
- All trademarks used in this user manual are the property of their respective owners.

TABLE OF CONTENTS

FOR YOUR SAFETY.....	1
SAFETY PRECAUTIONS.....	1
SPECIAL NOTES ON LCD MONITORS.....	3
CUSTOMER SERVICE.....	4
CLEANING.....	4
BEFORE YOU OPERATE THE MONITOR.....	5
FEATURES.....	5
CHECKING THE CONTENTS OF THE PACKAGE.....	5
UNPACKING.....	6
SPECIAL NOTES ON.....	6
CONTROLS AND CONNECTORS : MONITOR.....	7
INSTALLATION.....	8
CONTROLS AND CONNECTORS :	
REMOTE CONTROL (For maintenance).....	10
PREPARING THE REMOTE CONTROL.....	11
BASIC OPERATION.....	12
CONNECTING YOUR MONITOR.....	15
COMPUTER SETTING.....	17
OPERATING THE MONITOR.....	18
ADJUSTMENT MENU CONTENTS.....	20
POWER MANAGEMENT FEATURE.....	32
TROUBLE SHOOTING.....	33
RECYCLING INFORMATION.....	34
APPENDIX.....	35
SPECIFICATIONS.....	35
DIMENSIONS.....	36
COMPLIANT TIMING.....	37

FOR YOUR SAFETY

SAFETY PRECAUTIONS

WARNING

STOP OPERATING THE MONITOR WHEN YOU SENSE TROUBLE

If you notice any abnormal phenomena such as smoke, strange sounds or fumes, unplug the monitor and contact your dealer or iiyama service center immediately. Further use may be dangerous and can cause fire or electric shock.

NEVER REMOVE THE CABINET

High voltage circuits are inside the monitor. Removing the cabinet may expose you to the danger of fire or electric shock.

DO NOT PUT ANY OBJECT INTO THE MONITOR

Do not put any solid objects or liquids such as water into the monitor. In case of an accident, unplug your monitor immediately and contact your dealer or iiyama service center. Using the monitor with any object inside may cause fire, electric shock or damage.

INSTALL THE MONITOR ON A FLAT, STABLE SURFACE

The monitor may cause an injury if it falls or is dropped.

DO NOT USE THE MONITOR NEAR WATER

Do not use where water may be splashed or spilt onto the monitor as it may cause fire or electric shock.

OPERATE UNDER THE SPECIFIED POWER SUPPLY

Be sure to operate the monitor only with the specified power supply. Use of an incorrect voltage will cause malfunction and may cause fire or electric shock.

PROTECT THE CABLES

Do not pull or bend the power cable and signal cable. Do not place the monitor or any other heavy objects on the cables. If damaged, the cables may cause fire or electric shock.

ADVERSE WEATHER CONDITIONS

It is advisable not to operate the monitor during a heavy thunder storm as the continual breaks in power may cause malfunction. It is also advised not to touch the plug in these circumstances as it may cause electric shock.

CAUTION

INSTALLATION LOCATION

Do not install the monitor where sudden temperature changes may occur, or in humid, dusty or smoky areas as it may cause fire, electric shock or damage. You should also avoid areas where the sun shines directly on the monitor.

DO NOT PLACE THE MONITOR IN A HAZARDOUS POSITION

The monitor may topple and cause injury if not suitably located. Please also ensure that you do not place any heavy objects on the monitor, and that all cables are routed such that children may not pull the cables and possibly cause injury.

MAINTAIN GOOD VENTILATION

Ventilation slots are provided to keep the monitor from overheating. Covering the slots may cause fire. To allow adequate air circulation, place the monitor at least 10 cm (or 4 inches) from any walls.

Do not remove the tilt stand when operating the monitor. Ventilation slots on the back of the cabinet will be blocked and the monitor may overheat if the stand is removed. This may cause fire or damage. Operating the monitor on its back, side, upside down or on a carpet or any other soft material may also cause damage.

DISCONNECT THE CABLES WHEN YOU MOVE THE MONITOR

When you move the monitor, turn off the power switch, unplug the monitor and be sure the signal cable is disconnected. If you do not disconnect them, it may cause fire or electric shock.

UNPLUG THE MONITOR

If the monitor is not in use for a long period of time it is recommended that it is left unplugged to avoid accidents.

HOLD THE PLUG WHEN DISCONNECTING

To disconnect the power cable or signal cable, always pull it by the plug. Never pull on the cable itself as this may cause fire or electric shock.

DO NOT TOUCH THE PLUG WITH WET HANDS

Pulling or inserting the plug with wet hands may cause electric shock.

WHEN YOU INSTALL THE MONITOR ON YOUR COMPUTER

Be sure the computer is strong enough to hold the weight of the monitor, otherwise, you may damage your computer.

REMARK FOR 24/7 USAGE

This product is not specifically designed for 24/7 usage in all environments.

OTHERS

ERGONOMIC RECOMMENDATIONS

To eliminate eye fatigue, do not operate the monitor against a bright background or in a dark room. For optimal viewing comfort, the monitor should be just below eye level and 40-60 cm (16-24 inches) away from your eyes. When using the monitor over a prolonged time, a ten minute break every hour is recommended as looking at the screen continuously can cause eye strain.

SPECIAL NOTES ON LCD MONITORS

The following symptoms are normal with LCD monitors and do not indicate a problem.

NOTE

- When you first turn on the LCD monitor, the picture may not fit in the display area because of the type of computer that is used. In this case, adjust the picture position to the correct position.
- You may find slightly uneven brightness on the screen depending on the desktop pattern you use.
- Due to the nature of the LCD screen, an afterimage of the previous screen may remain after switching the image, when the same image is displayed for hours. In this case, the screen is recovered slowly by changing the image or turning off the Power Switch for hours.
- Max. non-stop operating time and conditions
 - (1) If a static image is displayed continuously, it is recommended to disrupt it with a motion picture.
 - (2) It is recommended to periodically change the background colour and background image.
 - (3) Recommended operating time is under 18 hours a day.
Suitable operating time on "Static Image" : Under 18 hours a day.
(The moving picture can be allowed for 24 hours a day.)
 - (4) If the screen is active for a longer period of time, it is recommended to
 - I. Run the screensaver (motion picture or black pattern)
 - II. Power off the system for a while
 - (5) Make sure that the screen is suitably ventilated, or is used in conjunction with climate control system if installed into any bespoke cabinets.
 - (6) We strongly recommend an active cooling system with fans for long operating times, especially for high luminance LCD models.
- This LCD cannot be used outdoors.
- If you use a cable longer than the supplied one, the picture quality is not guaranteed. Touch function can be disrupted if the USB cable length exceeds 3m.

CUSTOMER SERVICE

NOTE

- If you have to return your unit for service and the original packaging has been discarded, please contact your dealer or iiyama service center for advice or replacement packaging.

CLEANING

WARNING

- If you drop any materials or liquids such as water into the monitor when cleaning, unplug the power cable immediately and contact your dealer or iiyama service center.

CAUTION

- For safety reasons, turn off the power switch and unplug the monitor before you clean it.

NOTE

- To protect the LCD panel, do not scratch or rub the screen with a hard object.
- Never use any of the following strong solvents. These will damage the cabinet and the LCD screen.

Thinner

Benzine

Abrasive cleaner

Spray-type cleaner

Wax

Acid or Alkaline solvent

- Touching the cabinet with any product made from rubber or plastic for a long time may cause degeneration or loss of paint on the cabinet.

CABINET

Stains can be removed with a cloth lightly moistened with a mild detergent solvent. Then wipe the cabinet with a soft dry cloth.

LCD

Periodic cleaning with a soft dry cloth is recommended.

SCREEN

Don't use tissue paper etc. because these will damage the LCD screen.

BEFORE YOU OPERATE THE MONITOR

FEATURES

- ◆ Supports Resolutions up to 3840 × 2160
- ◆ High Contrast 1000:1 (Typical) / Brightness 500cd/m² (Typical: without Touch panel)
- ◆ Digital Character Smoothing
- ◆ Automatic Set-up
- ◆ Stereo Speakers
2 × 8W Stereo Speakers
- ◆ Plug & Play VESA DDC2B Compliant
Windows® XP/Vista/7/8/8.1/10 Compliant
- ◆ Power Management (VESA DPMS Compliant)
- ◆ VESA Mounting Standard (600mm×400mm) Compliant
- ◆ Support 24hrs/day usage (by moving picture condition)
- ◆ IPX1 Standard Compliant (Only front face)

CHECKING THE CONTENTS OF THE PACKAGE

The following accessories are included in your package. Check to see if they are enclosed with the monitor. If anything is missing or damaged, please contact your local iiyama dealer or regional iiyama office.

- | | | |
|--|------------------------------|------------------------------------|
| ■ Power Cable* | ■ HDMI Cable | ■ DisplayPort Cable |
| ■ USB Cable | ■ IR Extender Cable | ■ Remote Control (For maintenance) |
| ■ Button Battery CR2025 (for Remote Control) | ■ Clamper (For tying cables) | |
| ■ Cable Cover | ■ Safety Guide | ■ Quick Start Guide |

CAUTION * The rating of the Power Cable enclosed in 120V area is 10A/125V. If you are using a power supply higher than this rating, then a power cable with a rating of 10A/250V must be used. However, all guarantees and warranties are void for any problems or damage caused by a power cable not supplied by iiyama.

UNPACKING

- ① Before unpacking your monitor, prepare a stable, level, and clean surface near a wall outlet. Set the LCD Monitor box in an upright position and open from the top of the box before removing the top cushions.
- ② Remove the carton holders.
- ③ Remove the top cushion and take the accessories box and the Monitor out.

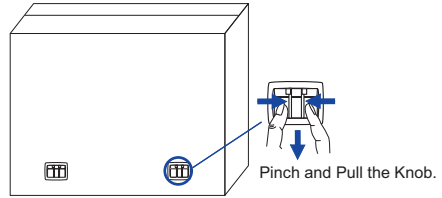

CAUTION

Moving the monitor requires at least two people. If not, it may drop and could result in a serious injury.

When moving/shipping the monitor, please hold by the carton holders.

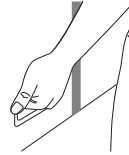

SPECIAL NOTES ON

CAUTION

Permanent damage can occur if Sharp Edged, Pointed or Metal items are used to activate Touch. This could invalidate any remaining warranty.

We recommend you use a plastic stylus (tip R0.8 or over) or finger.

CONTROLS AND CONNECTORS : MONITOR

<Front>

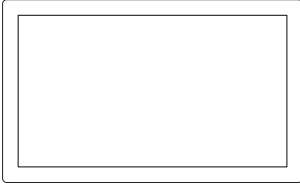

<Back>

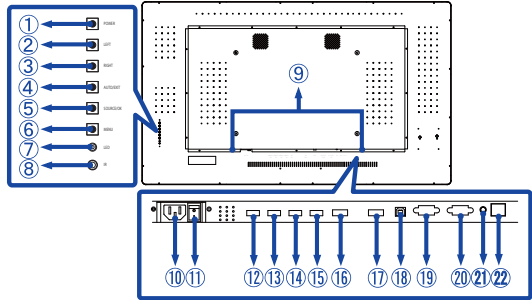

①	POWER	Power Button	
②	LEFT	Left/Volume + Button	
③	RIGHT	Right/Volume - Button	
④	AUTO / EXIT	Auto/Exit Button	
⑤	SOURCE / OK	Input Select/OK Button	
⑥	MENU	Menu Button	
⑦	LED	Green	Normal Operation
		Orange	Power Management
⑧	IR	Remote Sensor	
⑨	SPEAKERS	Speakers	
⑩	AC IN	AC-INLET	AC Connector(~ : Alternating current) (AC-IN)
⑪	AC SWITCH — (ON) / ○ (OFF)	MAIN POWER	Main Power Switch
⑫ ⑬ ⑭ ⑮	HDMI4 HDMI3 HDMI2 HDMI1	HDMI	HDMI Connector
⑯	DP IN	DisplayPort	DisplayPort Connector
⑰	DP OUT	DisplayPort	DisplayPort Connector
⑱	USB	USB	Touch USB Connector
⑳	RS232 OUT	D-SUB 9pin	RS232C Connector
㉑	RS232 IN	D-SUB 9pin	RS232C Connector
㉒	IR	Mini Jack	IR Extender Connector
㉓	LAN	RJ45	RJ45 Connector

INSTALLATION

CAUTION

- Follow the manual instructions for the type of mount you have selected. Refer all servicing to qualified service personnel.
- Moving the monitor requires at least two people.
- Before installing, please make sure the wall is strong enough to hold the necessary weight of the display and the mount.

[WALL MOUNTING]

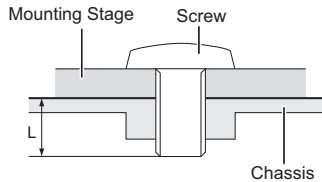

CAUTION

When using the wall mounting, consideration of thickness of the mounting stage needs to be taken. Tighten the M8 Screw with washer which "L" length is 10mm to fasten the monitor. Using a screw longer than this may cause electric shock or damage because it may contact with the electrical parts inside the monitor.

[FAN]

CAUTION

If the screen is used in face-up position, please be sure to turn on the FAN function. If you do not use the FAN, the internal temperature rises and the product life cycle may get shorter. If the screen is built into an external cabinet, please be sure to implement a cooling unit inside of the cabinet. Dirt and dust may stick to the FAN, reducing the cooling effect which may result in a shorter life cycle of the product. Please clean regularly.

[ROTATING THE DISPLAY]

It is designed to be compatible in both landscape and portrait modes.

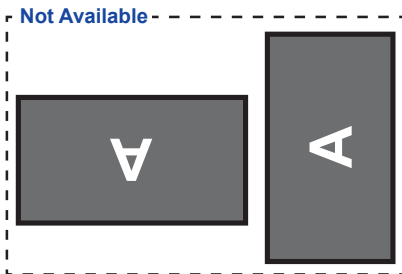
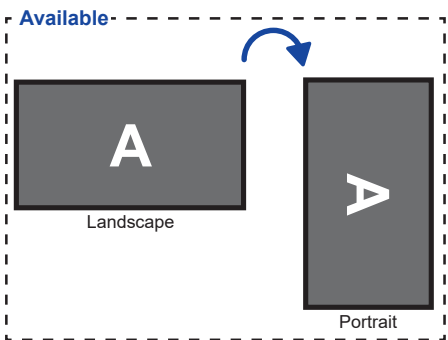

CONTROLS AND CONNECTORS : REMOTE CONTROL (For maintenance)

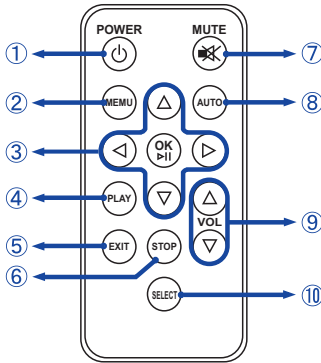

NOTE

To use the remote control we advise you to position it at the back of the monitor (left side) where the remote sensor is located. It might not work if you use it standing in front of the monitor.

①	POWER	Turns the monitor ON and OFF.
②	MENU	Opens the monitor's on-screen menu systems. When the menu system is already open, pressing this button will select the previous submenu.
③	▲▼◀▶	Navigates through submenus and settings. ▲: Up Button ▼: Down Button ◀: Left Button ▶: Right Button
	OK	Confirms your selection or save changes.
④	PLAY	Not available on this model.
⑤	EXIT	Returns to a previous menu or closes the OSD Menu.
⑥	STOP	Not available on this model.
⑦	MUTE	Turns on or off the mute function when the Menu is not displayed.
⑧	AUTO	Adjust H. / V. Position, Clock and Phase automatically.
⑨	VOL	▲: Increases the sound volume. ▼: Decreases the sound volume.
⑩	SELECT	Selects the source.

PREPARING THE REMOTE CONTROL

To use the remote control, insert the button battery.

CAUTION

Do not use any other batteries other than those specified in this manual for the Remote Control. Burst batteries or the electrolyte from these batteries may cause stains, fire or injury.

- ① Push Lock to right and remove the battery case in the direction of the arrow.



- ② Put it in face up the + side of the button battery (CR2025).

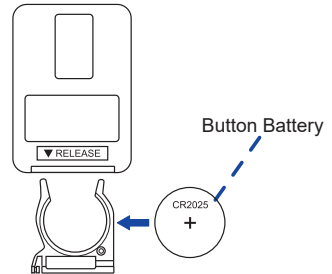

- ③ Replace the battery case in the direction of the arrow.



NOTE

- Replace with new batteries when the Remote Control does not work close to the monitor. Use the button battery (CR2025).
- Operate the Remote Control by pointing it toward the Remote Sensor on the monitor.
- Other manufacturers remote control will not work with this monitor. Use the provided Remote Control ONLY.
- Used batteries needed to follow the local rules to be discarded. (Suggestion: to dispose of used batteries please follow correct policy as per your local regulations.)

BASIC OPERATION

■ Turning the monitor ON

The monitor is on and the Power Indicator turns Green when you press the Power Button on the monitor or the Remote Control. The monitor is off and the Power Indicator turns Orange when you press the Power Button on the monitor or the Remote Control. Press again to turn the monitor on.

NOTE

Even when using the power management mode or turning OFF the Power Switch, the monitor will consume a small amount of electricity. Disconnect the Power Cable from the power supply whenever the monitor is not in use or during the night, to avoid unnecessary power consumption.

[Monitor]

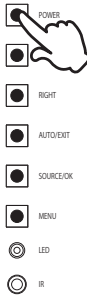

[Remote Control]



■ Display the adjustment menu page

The menu page appears on the screen when you press the MENU Button on the monitor or the Remote Control.

The menu page disappears when you press the EXIT Button on the Monitor or the Remote Control.

[Monitor]

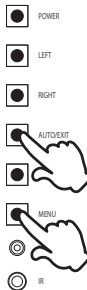

[Remote Control]

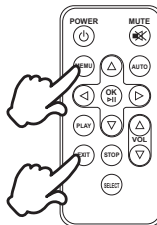

■ Move the cursor vertically

Select adjustment by pressing the UP / DOWN Button on the monitor or the ▲ / ▼ Button on the Remote Control while the menu page is displayed on the screen.

[Monitor]

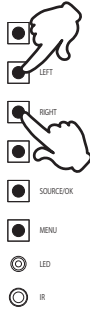

[Remote Control]

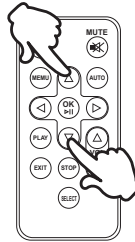

■ Move the cursor horizontally

Select menu or setting, or perform the adjustment by pressing the ◀ / ▶ Button on the Remote Control while the menu page is displayed on the screen.

[Remote Control]

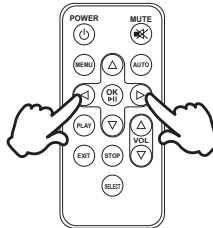

■ **Adjust the volume of sound**

Press the UP / DOWN Button on the Monitor or the VOL ▲ / ▼ Button on the Remote Control to adjust the volume of sound when the menu page is not displayed on the screen.

[Monitor]

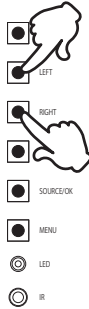

[Remote Control]

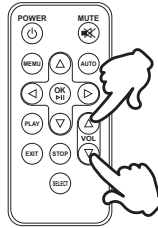

■ **Switch the input signal**

This is activated when you successively press the SOURCE Button on the monitor or SELECT Button on the Remote Control.

[Monitor]

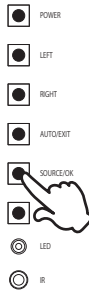

[Remote Control]

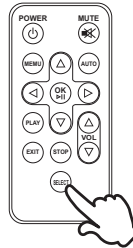

CONNECTING YOUR MONITOR

- ① Ensure that both the computer and the monitor are switched off.
- ② Connect the computer to the monitor with the signal cable.
- ③ Connect the computer to the monitor with the USB Cable.
- ④ Connect the IR Extender Cable to the monitor, peel off the double-sided tape in the back of the IR Receiver and stick it to your preferred location.
- ⑤ Connect the Power Cable to the monitor first and then to the power supply.
- ⑥ Turn on your monitor (Main Power Switch and Power Switch) and computer.

NOTE

- The signal cables used for connecting the computer and monitor may vary with the type of computer used. An incorrect connection may cause serious damage to both the monitor and the computer. The cable supplied with the monitor is for a standard connector. If a special cable is required please contact your local iiyama dealer or regional iiyama office.
- Make sure you tighten the finger screws at each end of the Signal Cable.
- Don't connect the RS-232C cable and the USB cable to the computer at the same time. And cannot use those at the same time.
- When USB cable connected than wait for 5 seconds and the touch function is ready to go. It can be activated by pen, finger or any other pointer.

[Example of Connection]

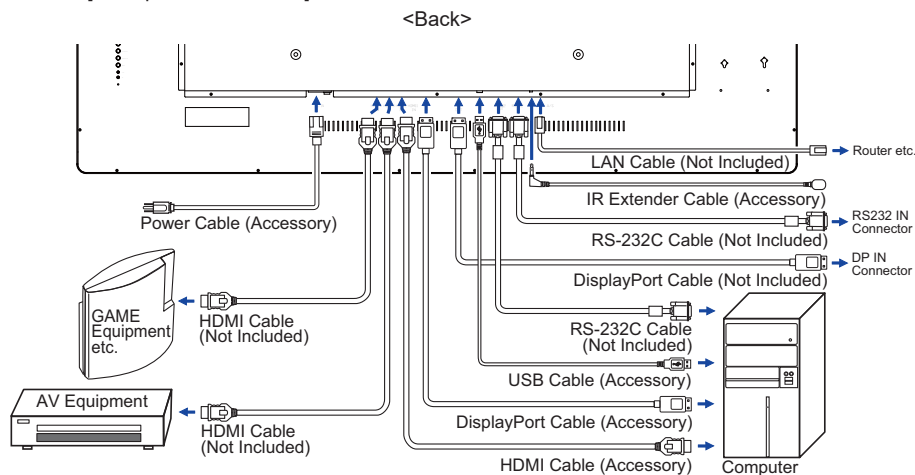

[Cable Cover]

Place the cable cover and fix it firmly using two screws that are included.

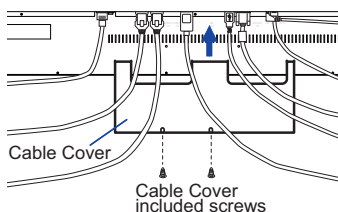

[About the daisy chain]

■ Monitor control connection

RS-232C

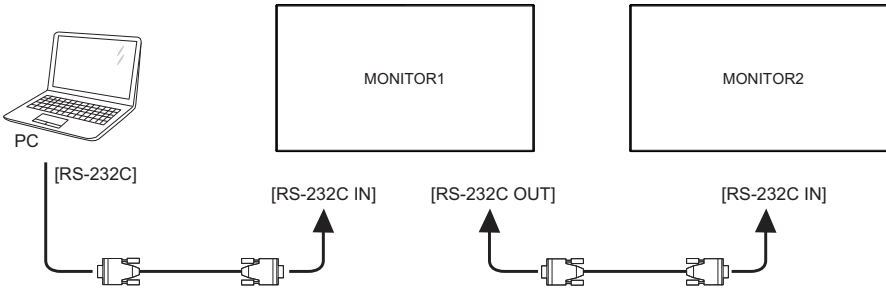

■ Digital video connection

DisplayPort

DisplayPort v1.2 multiple stream support allows daisy-chain up to 3 monitors showing different content on each screen.

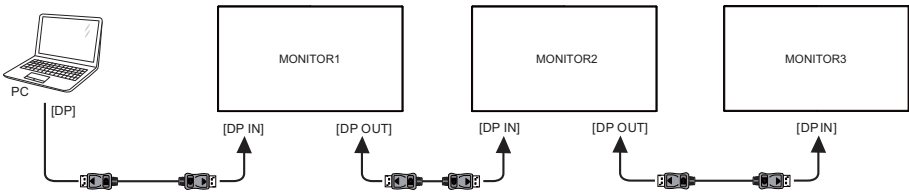

NOTE Connection conditions

- Up 2 monitors can be connected, when operating at 3840 × 2160 / 60Hz resolution.
(MONITOR1: 3840 × 2160 / 60Hz, MONITOR2: 1920 × 1080 / 60Hz)
- Up 2 monitors can be connected, when operating at 3840 × 2160 / 30Hz resolution.
(MONITOR1: 3840 × 2160 / 30Hz, MONITOR2: 3840 × 2160 / 30Hz)
- Up 3 monitors can be connected, when operating at 1920 × 1080 / 60Hz resolution.
(MONITOR1,2,3: 1920 × 1080 / 60Hz)

COMPUTER SETTING

■ Signal Timing

Change to the desired signal timing listed on page 37: COMPLIANT TIMING.

■ Windows XP/Vista/7/8/8,1/10 Plug & Play

The iiyama LCD monitor complies with DDC2B of VESA standard. The Plug & Play function runs on Windows XP/Vista/7/8/8,1/10 by connecting the monitor to DDC2B compliant computer with the Signal Cable supplied.

For installation on Windows XP: The monitor Information File for iiyama monitors may be necessary for your computer and obtained via the Internet, using the address:

<http://www.iiyama.com>

NOTE

- For additional information on how to download the driver for your touch screen monitor, please access the internet site noted above.

■ Procedure for turning ON the Power Switch

Turn ON the monitor first, and then the computer.

■ MULTI-TOUCH

This monitor complies with DDC2B of VESA standard. (Plug&play compliant)

The MULTI-TOUCH function runs on Windows7/8/8,1/10 by connecting the monitor to DDC2B compliant computer with the USB cable supplied.

■ MULTI-TOUCH support operation system

Microsoft Windows 7 (64 bit and 32 bit)

Microsoft Windows 8/8,1/10 (64 bit and 32 bit)

Linux (3.0x) & above

Not support Windows 2000 and earlier versions.

	Windows8/8,1/10	Windows7* ⁵	Windows7* ⁴	Linux
Default mouse* ¹	○	○	○	○
Touch digitizer* ²	○	○	○	×
Windows7 gestures* ³	○	○	×	×

*¹ Default mouse (click, drag, double-click and right-click)

*² Touch digitizer (click, drag /selection, double-click, right-click, flick and visual feedback)

*³ Digitizer with Windows7 multi-touch gestures

*⁴ Windows 7 - Starter and Home Basic version

*⁵ Windows 7 - Home Premium, Professional, Enterprise and Ultimate versions

OPERATING THE MONITOR

To create the best picture, your iiyama LCD monitor has been preset at the factory with the COMPLIANT TIMING shown on page 37. You are also able to adjust the picture by following the button operation shown below.

- 1 Press the MENU Button to start the On Screen Display feature. There are additional Menu items which can be switched by using the ◀/▶ Buttons.



- 2 Select the Menu item of the adjustment you want to make. Press the OK Buttons and enter the menu page. Then, use the ◀/▶ Buttons to highlight the desired adjustment item.
- 3 Press the OK Buttons again. Use the ◀/▶ Buttons to make the appropriate adjustment or setting.
- 4 Press the EXIT Button to leave the menu, and the settings you just made would be automatically saved.

For example, to correct for OSD vertical position, select Menu item of "Other". Select "OSD V. Position" by using the ◀/▶ Buttons. Press the OK Button. Use the ◀/▶ Buttons to change the OSD vertical position settings. The OSD vertical position of the overall display should be changing accordingly while you are doing this.

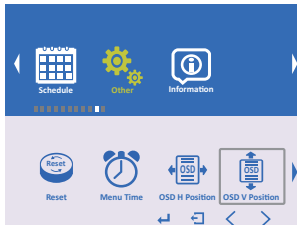

Press the EXIT Button lastly, it ends, all changes are saved in the memory.

NOTE

- When button operations are aborted during adjustment, On-Screen Display disappears when the time set for the Menu time has passed.
- The EXIT Button can be used to return previous menu item.
- Any changes are automatically saved in the memory when the On Screen Display disappears. Turning off the power should be avoided while using the Menu.

● **LOCK MODE:** * Available for OSD key button only.

Pressing and holding the MENU button and the Power Switch for about 3 seconds when the Menu is not displayed.

* The OSD menu is not displayed when the OSD is locked. Pressing and holding the MENU button and the Power Switch for about 3 seconds when the Menu is not displayed.

The following OSD menu is displayed.

Adjustment Item	Problem / Option	
OSD Lock	On	The OSD menu is Locked.
	Off	The OSD menu is Unlocked.
Power Key Lock	On	The POWER SWITCH is Locked.
	Off	The POWER SWITCH is Unlocked.
Remocon Lock	On	The Remote Control is Locked.
	Off	The Remote Control is Unlocked.

● **PALM REJECTION FUNCTION:**

Palm rejection is a way to disregard touch made with “a large contact area” while using pen or finger modes.

A large contact area : palm, clenched fist, elbow, arm, etc.

When you touch the screen with a pen or a finger, palm rejection is activated and the screen does not recognize touch made with the large contact area.

NOTE

The screen works only with conductive pens with $\Phi 5-6$ mm diameter.





The touch panel does not recognize pens with smaller or large diameter.



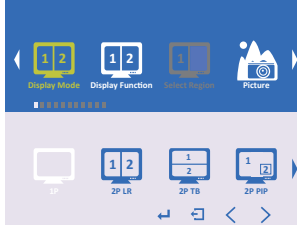





Touch made by a pen is not recognized within 15mm distance from edge of the active display area.

ADJUSTMENT MENU CONTENTS

Display Mode



Adjustment Item	Problem / Option	Button to Press
Set the output mode of the screen.		
 1P	1 input signal	
 2P LR	2 input signals (Left/Right)	
 2P TB	2 input signals (Top/Bottom)	
 2P PIP	2 input signals (PIP)	
 4P	4 input signals (Quad monitor)	

Adjustment Item		Problem / Option	Button to Press
	Disp Rotate* ¹	Rotate the screen clockwise. 0 / 90 / 180 / 270	
	LR Ratio* ²	Change the left and right of the monitor ratio. 0(1 : 1) - 4(Left-big : Right-small)	
	Input Swap* ^{2,3,4}	Swap the Left/Right screens.	
	PIP Position* ⁴	Select the position of sub-screen. Left Top / Right Top / Left Bottom / Right Bottom / Center / User(PIP H Position / PIP V Position)	
	PIP Transparency* ⁴	Set the transmittance of the sub-screen background.	
	PIP Size* ⁴	Set the size of the sub-screen.	

*¹ Available for 1P only.









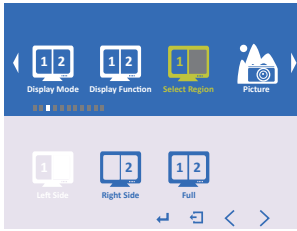









*² Available for 2P LR only.









*³ Available for 2P LR, 2P TB and 2P PIP only.

*⁴ Available for 2P PIP only.

Select Region











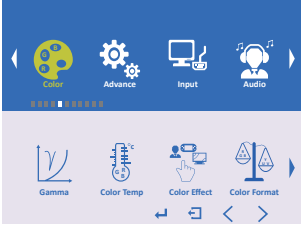





Adjustment Item	Problem / Option	Button to Press
<p>You can select the configuration screen, when you are viewing two or more screens. Only the following display settings can be adjusted: Brightness, Contrast, Sharpness, Gamma, Temperature, Color Effect, Color Format, Hue, Saturation</p>		
<p>If Display Mode is set to 2P LR</p>	<div style="display: flex; justify-content: space-around; align-items: center;"> <div style="text-align: center;">  Left Side </div> <div style="text-align: center;">  Right Side </div> <div style="text-align: center;">  Full </div> </div>	
<p>If Display Mode is set to 2P TB</p>	<div style="display: flex; justify-content: space-around; align-items: center;"> <div style="text-align: center;">  Top Side </div> <div style="text-align: center;">  Bottom Side </div> <div style="text-align: center;">  Full </div> </div>	
<p>If Display Mode is set to 2P PIP</p>	<div style="display: flex; justify-content: space-around; align-items: center;"> <div style="text-align: center;">  Main </div> <div style="text-align: center;">  Sub </div> <div style="text-align: center;">  Full </div> </div>	
<p>If Display Mode is set to 4P</p>	<div style="display: flex; justify-content: space-around; align-items: center;"> <div style="text-align: center;">  1P - In </div> <div style="text-align: center;">  1P - Out </div> <div style="text-align: center;">  2P - In </div> <div style="text-align: center;">  2P - Out </div> </div>	
	<div style="display: flex; justify-content: space-around; align-items: center;"> <div style="text-align: center;">  3P - In </div> <div style="text-align: center;">  3P - Out </div> <div style="text-align: center;">  4P - In </div> <div style="text-align: center;">  4P - Out </div> </div>	
	<div style="text-align: center;">  4P - Full </div>	

Adjustment Item		Problem / Option	Button to Press
<p>Picture</p> 			
	Backlight	Brightness of back light is reduced.	
	Brightness* ^{1,2}	Too soft Too sharp	
	Contrast* ²	Too dull Too intense	
	Sharpness* ²	You can change the picture quality from 0 to 4 (soft to sharp). Press the ◀ Button to change the picture quality in numerical order. Press the ▶ Button to change the picture quality in reverse numerical order.	

*¹ Adjust the Brightness when you are using the monitor in a dark room and feel the screen is too bright.

*² If you select "Select Region", only the selected screen will be adjusted.

Color			
Adjustment Item	Problem / Option	Button to Press	
 Gamma*	You can set the Gamma. OFF / 1.8 / 2.2		
 Temperature*	1000k	More bluish white	
	9300k	Bluish white	
	6500k	Reddish white	
	USER	RED GREEN BLUE	Too weak Too strong
 Color Effect*	Standard	For general windows environment and monitor default setting.	
	Game	For PC game environment.	
	Movie	For movie and video environment.	
	Photo	For displaying outdoor scenery images.	
 Color Format*	RGB	RGB color signal	
	YUV	YUV color signal	
 Hue*	Purplish Greenish		   
 Saturation*	Too weak Too strong		   

* If you select "Select Region", only the selected screen will be adjusted.

Adjustment Item		Problem / Option		Button to Press
<div style="text-align: center;"> </div>				
	Aspect Ratio	Full	Full screen display.	
		16:10	Displays all picture in 16:10 aspect ratio.	
		5:4	Displays all picture in 5:4 aspect ratio.	
		4:3	Displays all picture in 4:3 aspect ratio.	
	Over Scan	ON	Activate Overscan to reduce picture noise.	
		OFF	Deactivate Overscan	
	DP Option* ¹	1.1	Standard	
		1.2	To be used when displaying 3840x2160 60Hz.	
	DP MST* ^{1,2,3}	ON	Enable the Multi Stream Screen of the daisy chain monitor.	
		OFF	Return to the Single Stream Screen of the daisy chain monitor.	

*¹ Available for DisplayPort input only.

*² See page 16 for "Digital video connection".

*³ About the Multi Stream Screen and the Single Stream Screen.

[Multi Stream Screen] * PC detects the 3 monitor.

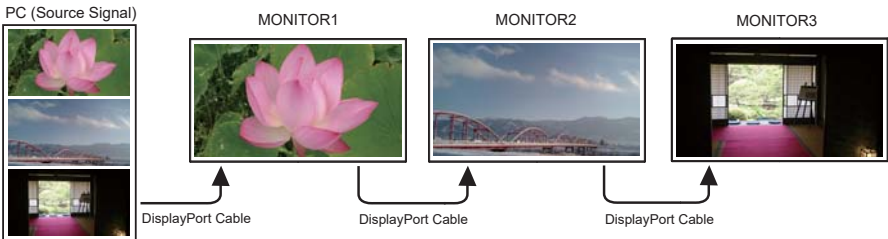

[Single Stream Screen] * PC detects the 1 monitor.

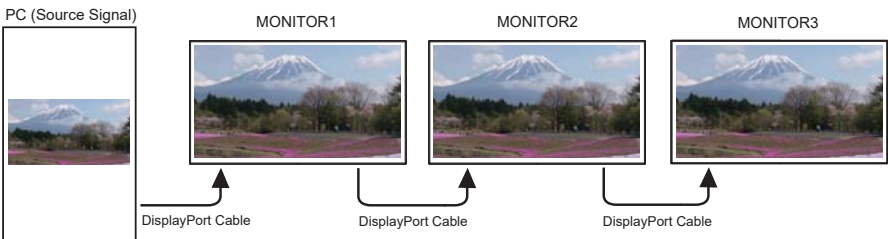

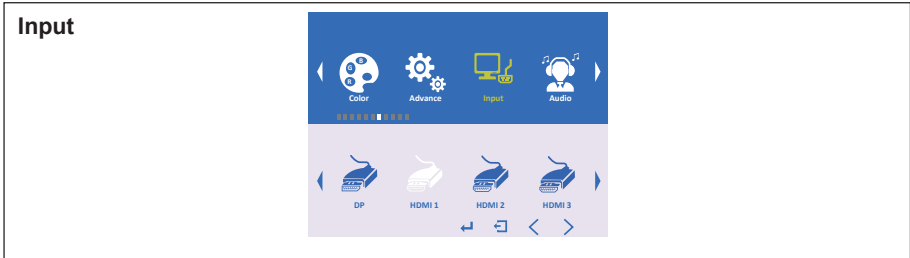





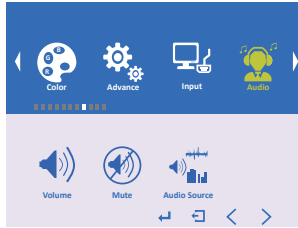

Adjustment Item		Problem / Option		Button to Press
If Display Mode is set to 1P		DP	Select the digital(DP) input.	
		HDMI1	Select the digital(HDMI1) input.	
		HDMI2	Select the digital(HDMI2) input.	
		HDMI3	Select the digital(HDMI3) input.	
		HDMI4	Select the digital(HDMI4) input.	
		Auto Select	Select the signal input automatically.	
If Display Mode is set to 2P LR	Left Side	DP	Select the digital(DP) input.	
		HDMI1	Select the digital(HDMI1) input.	
		HDMI2	Select the digital(HDMI2) input.	
	Right Side	HDMI3	Select the digital(HDMI3) input.	
		HDMI4	Select the digital(HDMI4) input.	
		Auto Select	Select the signal input automatically.	
If Display Mode is set to 2P TB	Top Side	DP	Select the digital(DP) input.	
		HDMI1	Select the digital(HDMI1) input.	
		HDMI2	Select the digital(HDMI2) input.	
	Bottom Side	HDMI3	Select the digital(HDMI3) input.	
		HDMI4	Select the digital(HDMI4) input.	
		Auto Select	Select the signal input automatically.	
If Display Mode is set to 2P PIP	Main	DP	Select the digital(DP) input.	
		HDMI1	Select the digital(HDMI1) input.	
		HDMI2	Select the digital(HDMI2) input.	
	Sub	HDMI3	Select the digital(HDMI3) input.	
		HDMI4	Select the digital(HDMI4) input.	
		Auto Select	Select the signal input automatically.	
If Display Mode is set to 4P	1P - In	DP	Select the digital(DP) input.	
		HDMI1	Select the digital(HDMI1) input.	
	2P - In	HDMI2	Select the digital(HDMI2) input.	
		HDMI3	Select the digital(HDMI3) input.	
	3P - In	HDMI4	Select the digital(HDMI4) input.	
		4P - In	Auto Select	Select the signal input automatically.

NOTE When only one of the five signal inputs is connected to the signal source, the one connected is automatically selected. Input Source function is not available if there is no signal input from the selected connector or during the power management mode.





Audio



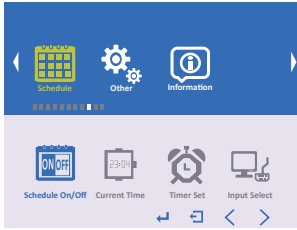







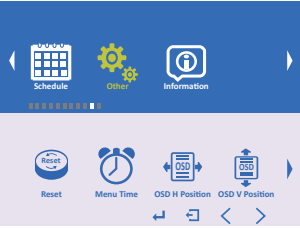

















Adjustment Item	Problem / Option		Button to Press
 Volume	Too soft Too loud		 
 Mute	ON	Turn off the sound temporarily.	
	OFF	Return the sound volume to the previous level.	
 Audio Source	Digital Region1(LT)	Outputs the sound of the screen which selected.	
	Digital Region2(LB)	Outputs the sound of the screen which selected.	
	Digital Region3(RT)	Outputs the sound of the screen which selected.	
	Digital Region4(RB)	Outputs the sound of the screen which selected.	

Schedule







Adjustment Item		Problem / Option		Button to Press
	Schedule On/Off	ON	Schedule is turned on.	
		OFF	Schedule is turned off.	
	Current Time	Adjust the current date and time for the internal clock. Year / Month / Day / Hour / Minute		
	Timer Set	Sets a recurring schedule. Everyday / Sunday / Monday / Tuesday / Wednesday / Thursday / Friday / Saturday Timer On/Off : ON / OFF On Timer : On Time Hour / On Time Minute Off Timer : Off Time Hour / Off Time Minute		
	Input Select	If Display Mode is set to 1P	DP	Select the digital(DP) input.
		If Display Mode is set to 2P LR	Left Side	HDMI1
	Right Side			
	If Display Mode is set to 2P TB	Top Side	HDMI2	Select the digital(HDMI2) input.
		Bottom Side		
	If Display Mode is set to 2P PIP	Main	HDMI3	Select the digital(HDMI3) input.
		Sub		
	If Display Mode is set to 4P	1P - In	HDMI4	Select the digital(HDMI4) input.
2P - In				
3P - In		Auto Select	Select the signal input automatically.	
4P - In				
	Reset	ON	Resets all settings in the Schedule menu.	
		OFF	Return to Menu.	

Other					
Adjustment Item	Problem / Option		Button to Press		
 Reset *1	ON	Factory-preset data is restored.			
	OFF	Return to Menu.			
 Menu Time	You can set the OSD display duration time between 10 and 60 seconds.			 	
 OSD H. Position	OSD is too left		 		
	OSD is too right		 		
 OSD V. Position	OSD is too low		 		
	OSD is too high		 		
 Language	English	English	Nederlands	Dutch	
	Français	French	Poliski	Polish	
	Español	Spanish	Русский	Russian	
	Deutsch	German	Italiano	Italian	
 Transparency	Set the transmittance of the OSD background.			 	
 Rotate	Rotate the OSD clockwise. 0 / 90 / 270				
 Border Width	Set the border thickness of the screen.			 	
 Border Color	Set the border color of the screen. R / G / B / W				
 Fan *2	ON	Fan is turned on.			
	OFF	Fan is turned off.			
 Model Info	Displays information regarding your monitor. Model Name / IP Address / Gateway / Subnet Mask Port				

*1 When the Reset is being performed, the Schedule will also be reset.

*2 If the screen is used in face-up position, please be sure to turn on the FAN function.



Adjustment Item		Problem / Option		Button to Press
	LAN*	ON	Enable the LAN.	
		OFF	Disable the LAN.	
	Wake Up	ON	Enable to return from the standby screen.	
		OFF	Wake Up is turned off.	
	Serial*	ON	Enable the RS232C.	
		OFF	Disable the RS232C.	
	Logo	ON	iiyama Logo displayed when the monitor is turned on.	
		OFF	iiyama Logo does not display when the monitor is turned on.	
	Auto Power Down	ON	Going sleep mode after 3 hours display.	
		OFF	Auto Power Down is turned off.	

* If you want to use a LAN or RS232C control, please contact your dealer or your iiyama service center.

Information

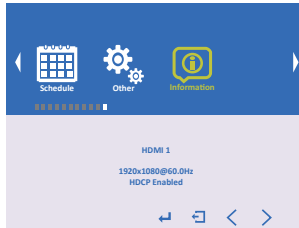

Displays information regarding the current input signal coming from the graphic card in your computer.

NOTE See your graphic card user guide for more information about changing the resolution and refresh.

POWER MANAGEMENT FEATURE

The power management feature of this product complies with power saving requirement of VESA DPMS. When activated, it automatically reduces unnecessary power consumption of the monitor when your computer is not in use.

To use the feature, the monitor needs to be connected to a VESA DPMS compliant computer. There is a power management step the monitor takes as described below. The power management function, including any timer settings is configured by the operating system. Check your operating system manual for information on how this can be configured.

■ Power Management Mode

When the H-sync signal / V-sync signal / H and V sync signals from the computer are off, the monitor enters into Power Management Mode which reduces the power consumption to less than 0.5W. The screen becomes dark. From Power Management Mode, the image reappears in several seconds when either the keyboard or the mouse are touched again.

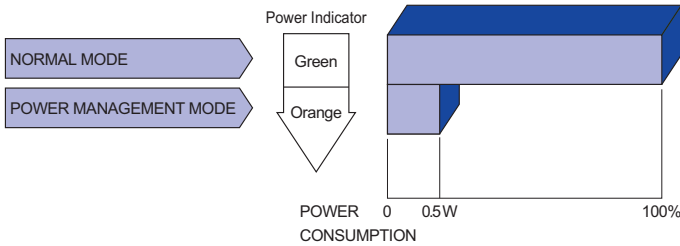

NOTE

- Even when using the power management mode, the monitor consumes electricity. Turn off the Power Switch whenever the monitor is not in use, during the night and weekends, to avoid unnecessary power consumption.
- It is possible that the video signal from the computer may be on while the H or V sync signal is missing. In this instance, the POWER MANAGEMENT feature may not work properly.

TROUBLE SHOOTING

If the monitor fails to operate correctly, please follow the steps below for a possible solution.

1. Perform the adjustments described in OPERATING THE MONITOR, depending on the problem you have. If the monitor does not get a picture, skip to 2.
2. Consult the following items if you cannot find an appropriate adjustment item in OPERATING THE MONITOR or if the problem persists.
3. If you are experiencing a problem which is not described below or you cannot correct the problem, discontinue using the monitor and contact your dealer or iiyama service center for further assistance.

Problem	Check
① The picture does not appear.	<input type="checkbox"/> The Power Cable is firmly seated in the socket. <input type="checkbox"/> The Power Switch is turned ON. <input type="checkbox"/> The AC socket is live. Please check with another piece of equipment. <input type="checkbox"/> If the blank screen saver is in active mode, touch the keyboard or the mouse. <input type="checkbox"/> Increase the Contrast and/or Brightness. <input type="checkbox"/> The computer is ON. <input type="checkbox"/> The Signal Cable is properly connected. <input type="checkbox"/> The signal timing of the computer is within the specification of the monitor. <input type="checkbox"/> If the monitor is in power management mode, touch the keyboard or the mouse.
② The screen is not synchronized.	<input type="checkbox"/> The Signal Cable is properly connected. <input type="checkbox"/> The signal timing of the computer is within the specification of the monitor. <input type="checkbox"/> The video output level of the computer is within the specification of the monitor.
③ The screen position is not in the center.	<input type="checkbox"/> The signal timing of the computer is within the specification of the monitor.
④ The screen is too bright or too dark.	<input type="checkbox"/> The video output level of the computer is within the specification of the monitor.
⑤ The screen is shaking.	<input type="checkbox"/> The power voltage is within the specification of the monitor. <input type="checkbox"/> The signal timing of the computer is within the specification of the monitor.
⑥ No sound.	<input type="checkbox"/> The audio equipment (computer etc.) is ON. <input type="checkbox"/> The Audio Cable is properly connected. <input type="checkbox"/> The Volume is turned up. <input type="checkbox"/> The Mute is OFF. <input type="checkbox"/> The audio output level of the audio equipment is within the specification of the monitor.
⑦ The sound is too loud or too quiet.	<input type="checkbox"/> The audio output level of the audio equipment is within the specification of the monitor.
⑧ A strange noise is heard.	<input type="checkbox"/> The Audio Cable is properly connected.
⑨ The touch screen shows no response.	<input type="checkbox"/> The USB Cable is firmly seated in the socket. <input type="checkbox"/> Touch screen driver software is installed.
⑩ The touch position does not deviate.	<input type="checkbox"/> The calibration function set up correctly.

RECYCLING INFORMATION

For better environment protection please don't dispose your monitor.
Please visit our web site: www.iiyama.com/recycle for monitor recycling.

ENGLISH

APPENDIX

Design and specifications are subject to change without prior notice.

SPECIFICATIONS

Touch Screen	Technology	Projected Capacitive 50points* ¹
	Light transmission	80% min.
	Hardness	10H
	Thickness	5mm
	Communication system	USB serial transfer
Size Category		65"
LCD Panel	Panel technology	IPS
	Size	Diagonal: 65" (165cm)
	Pixel pitch	0.372mm H × 0.372mm V
	Brightness	500cd/m ² (Typical: without Touch panel), 400cd/m ² (Typical: with Touch panel)
	Contrast ratio	1000 : 1 (Typical)
	Viewable angle	Horizontal : 178 degrees, Vertical: 178 degrees (Typical)
	Response time	8ms (Gray to Gray)
	Pixel format	3840(H), 2160(V) Pixels
Display Colors		Approx.16.7M
Sync Frequency		DisplayPort In/Out: Horizontal: 30.0-135.0kHz, Vertical: 24-30,55-75Hz HDMI1: Horizontal: 30.0-135.0kHz, Vertical: 24-30,55-75Hz HDMI2/3/4: Horizontal: 30.0-90.0kHz, Vertical: 24-30,55-75Hz
Supported max. resolution		DisplayPort In/Out: 3840 × 2160, 60Hz HDMI1: 3840 × 2160, 60Hz HDMI2/3/4: 3840 × 2160, 30Hz
Input Connector		HDMI × 4, DisplayPort In/Out ×1
Control Connector		RS-232C In/Out, LAN
Plug & Play		VESA DDC2B™
Input Video Signal		Digital: HDMI, DisplayPort
Speakers		8W × 2 (Stereo speakers, Support DisplayPort/HDMI-Audio)
IR Connector		IR Extender
Maximum Screen Size		1430.4mm W × 805.6mm H / 56.3" W × 31.7" H
Power Source		100-240VAC, 50/60Hz, 1.5A
Power Consumption* ²		105W typical, Power management mode: 0.5W maximum Energy Efficiency Class: A+
Dimensions / Net Weight		1530.5 × 905.5 × 67.5mm / 60.3 × 35.6 × 2.6" (W×H×D) 60.0kg / 132.3lbs
Environmental Considerations		Operating: Temperature 0 to 40°C / 32 to 104°F Humidity 85% (No condensation) Storage: Temperature -20 to 60°C / 4 to 140°F Humidity 85% (No condensation)
Approvals		CE, TÜV-Bauart, CU, IPX1* ³

NOTE *¹ Windows OS application software have a limited touch pts. (max. 10pts only)

*² USB peripherals / Audio equipment are not connected.

*³ IPX1 Standard Compliant : Only front face

DIMENSIONS

ENGLISH

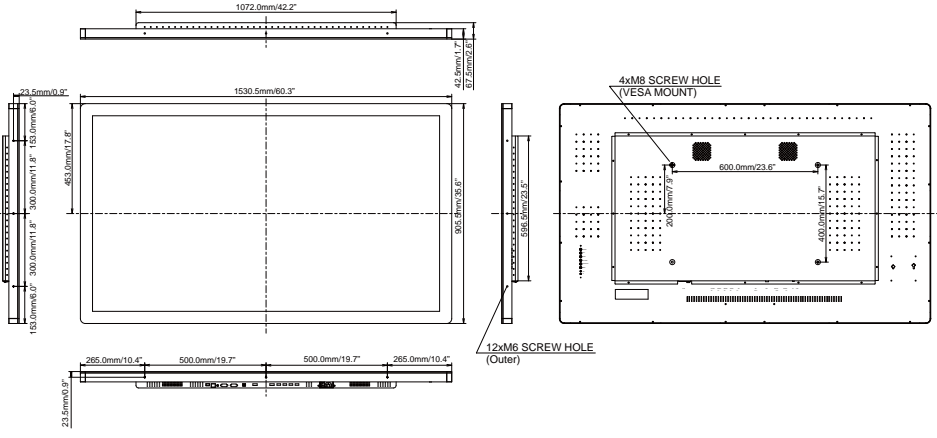

COMPLIANT TIMING

Video Mode			Horizontal Frequency	Vertical Frequency	Dot Clock	
VESA	VGA	640 × 480	31.469kHz	59.940Hz	25.175MHz	
	SVGA	800 × 600	37.879kHz	60.317Hz	40.000MHz	
	XGA	1024 × 768	48.363kHz	60.004Hz	65.000MHz	
		1280 × 768	47.776kHz	59.870Hz	79.500MHz	
	SXGA	1280 × 1024	63.981kHz	60.020Hz	108.000MHz	
	Full HD	1920 × 1080	66.590kHz	59.930Hz	138.500MHz	*1
		1920 × 2160	135.000kHz	60.000Hz	297.000MHz	*2
	WQHD	2560 × 1440	88.787kHz	59.951Hz	241.500MHz	
		3840 × 1080	135.000kHz	60.000Hz	297.000MHz	*3
UHD	3840 × 2160	67.430kHz	29.970Hz	296.700MHz	*4	
		133.313kHz	59.997Hz	533.250MHz	*5	
	480p	60Hz	31.469kHz	59.940Hz	27.000MHz	
	576p	50Hz	31.250kHz	50.000Hz	27.000MHz	
HD	720p	50Hz	37.500kHz	50.000Hz	74.250MHz	
	720p	60Hz	45.000kHz	60.000Hz	74.250MHz	
	1080p	24Hz	27.000kHz	24.000Hz	74.250MHz	
	1080p	30Hz	33.750kHz	30.000Hz	74.250MHz	
	1080p	50Hz	56.250kHz	50.000Hz	148.500MHz	
	1080p	60Hz	67.500kHz	60.000Hz	148.500MHz	

NOTE

- *1 Recommended to use on 4P.
- *2 Recommended to use on 2P LR.
- *3 Recommended to use on 2P TB.
- *4 HDMI2, HDMI3 and HDMI4 maximum supported resolution.
- *5 DisplayPort-In/Out and HDMI1 maximum supported resolution.