



# Touchscreen display

## Safety & Recommendations

[English](#)

[Deutsch](#)

[Nederlands](#)

[Français](#)

[Español](#)

## Table of contents

<b>01 IMPORTANT INFORMATION</b>	<b>3</b>
<b>1.1 USE</b>	<b>3</b>
<b>1.2 EXEMPTIONS</b>	<b>4</b>
<b>02 SAFETY INSTRUCTIONS</b>	<b>4</b>
<b>2.1 SAFETY PRECAUTIONS</b>	<b>4</b>
<b>2.2 MOVING AND CARRYING NOTICE</b>	<b>5</b>
<b>2.3 INSTALLATION</b>	<b>5</b>
<b>2.4 WALLMOUNT SAFETY NOTICE</b>	<b>6</b>
<b>2.5 RECOMMENDED USE</b>	<b>7</b>
<b>2.6 CLEANING</b>	<b>8</b>

# IMPORTANT INFORMATION

## 1. IMPORTANT INFORMATION



**WARNING:**

TO PREVENT FIRE OR SHOCK HAZARDS, DO NOT EXPOSE THIS UNIT TO RAIN OR MOISTURE. ALSO, DO NOT USE THIS UNIT'S POLARIZED PLUG WITH AN EXTENSION CORD RECEPTACLE OR OTHER OUTLETS UNLESS THE PRONGS CAN BE FULLY INSERTED. REFRAIN FROM OPENING THE E-SCREENS HOUSING AS THERE ARE HIGH VOLTAGE COMPONENTS INSIDE.



**CAUTION:**

TO REDUCE THE RISK OF ELECTRIC SHOCK, MAKE SURE POWER CORD IS UNPLUGGED FROM WALL SOCKET. TO FULLY DISENGAGE THE POWER TO THE UNIT, PLEASE DISCONNECT THE POWER CORD FROM THE AC OUTLET. DO NOT REMOVE COVER (OR BACK). NO USER SERVICEABLE PARTS INSIDE. REFER SERVICING TO QUALIFIED SERVICE.



**WARNING:**

FOR CONTINUED SAFETY, DEVICES WITH CLASS I CONSTRUCTION SHALL BE CONNECTED TO A MAIN SOCKET OUTLET WITH A PROTECTIVE EARTHING CONNECTION.



**WARNING:**

THIS IS A CLASS A PRODUCT MEANT TO BE USED IN PROFESSIONAL ENVIRONMENTS. - THIS PRODUCT MUST NOT BE USED IN RESIDENTIAL AREAS.

### 1.1. USE

- Transport the product upright with proper packaging. Avoid placing the product face up or down. Handle with care!
- Do not send a static (non-moving) image to the e-screen, it may cause image 'burn-in' or image retention.
- "Burn in" and/or image retention is not covered under warranty.
- Make sure to change the image on the e-screen periodically. It is recommended to turn off the e-screen for at least 6 hours after 16 hours of usage in a 24-hour period to help avoid image retention.

# SAFETY INSTRUCTIONS

## 1.2. EXEMPTIONS

- This product isn't warranted for any damage caused by natural disaster (such as earthquake, thunder, etc.), fire, acts by third parties, accidents, owner's intentional misuse and fault, or use in other improper conditions.
- This product isn't warranted for incidental damages (such as profit loss or interruption in business, modification or erasure of record data, etc.) caused by use or inability to use of this product.
- This product isn't warranted for any damage caused by inappropriate operation, or from not following the user manual.
- This product isn't warranted for any damage caused by misuse or malfunction through simultaneous use of this product and the connected equipment or software.
- This product isn't warranted for any damage caused by neglect of the installation instructions.
- This product isn't warranted for any damage caused by improper installation.
- This product isn't warranted for any damage caused by disassembly, modification or repair by non-authorized service centers or people.

## 2. SAFETY INSTRUCTIONS

Before using this e-screen, please read this user manual thoroughly to help protect against property damage and to ensure your personal safety and the safety of others.

- Read and follow all instructions and safety-warnings found in this manual.
- For installation or adjustment, please follow the instructions in this manual and refer all servicing to qualified service personnel.

## 2.1 SAFETY PRECAUTIONS

**If smoke or a peculiar smell comes from the e-Screen, remove the power plug from the outlet immediately.** Failure to do so may result in fire or electrical shock.

Contact your dealer for inspection.

**If the e-Screen has been turned on but there is no picture, remove the power plug from the outlet immediately.** Failure to do so may result in fire or electrical shock.

Contact your dealer for inspection.

**If water is spilled or objects are dropped inside the e-Screen, remove the power plug from the outlet immediately.** Failure to do so may result in fire or electrical shock.

Contact your dealer for inspection.

**If the e-Screen is dropped or the e-screen's housing is damaged, remove the power plug from the outlet immediately.** Failure to do so may result in fire or electrical shock.

Contact your dealer for inspection.

**If the power cord or plug is damaged or becomes hot, turn off the main power switch of the e-Screen, make sure the power plug has cooled down and remove the power plug from the outlet.**

If the e-Screen is still used in this condition, it may cause fire or electrical shock. Contact your dealer for replacement.

# SAFETY INSTRUCTIONS

## 2.2 MOVING AND CARRYING NOTICE

### Moving the product:

Moving the product requires at least four people. Attempting to move the product with fewer people may result in damage to the display or in serious injury of the people handling the screen. When moving a display in its shipping carton, lift the carton using the white handles.



### Carrying the product:

This product is heavy; please follow proper lifting techniques, as pictured below. Failure to do so may cause injury.



## 2.3 INSTALLATION

### Don't install in a high-temperature environment.

If the e-screen is used in high-temperatures or in direct sunlight, it may cause the housing of the product or other parts to become distorted or damaged, resulting in overheating or electrical shock.

### Don't install in a high-humidity environment.

This may cause overheating or electrical shock.

### Don't install near any heat sources such as radiators, heat registers, stoves, or other apparatus that produce heat.

This may cause fire or electrical shock.

### Don't overload outlets or cables beyond electrical capacity. Don't use extension cords as it may cause fire or electrical shock.

### Don't insert the power plug into an outlet other than 100~240V AC.

This may cause fire or electrical shock.

- Don't use a damaged power plug or worn outlet.
- Don't insert an improper power plug it may cause fire or electric shock.

### Don't place the e-screen on an unstable shelf or surface. The e-screen may fall, causing injury. Please install on a horizontal, stable, level surface.

### Don't place objects on the e-screen.

- If the e-screen is covered or the vents are blocked, the display could overheat and cause a fire.
- If objects or liquids get inside the e-screen, this may cause fire or electrical shock.
- Do not put heavy objects on the e-screen as they may fall, causing injury.
- Please keep a 10 cm minimum distance between e-screen, wall and/or other objects to ensure sufficient ventilation.

# SAFETY INSTRUCTIONS

Don't move the e-screen when it is connected to the power cord and AV cables.

- When moving the e-screen, make sure to remove all cables first.
- When unpacking or carrying the e-screen, at least 4 people are needed. Make sure the e-screen is carried upright.
- Transport the e-screen upright. Avoid placing the e-screen face up or down.
- Handle the e-screen gently. Do not drop.

## 2.4 WALLMOUNT SAFETY NOTICE

1. Please make sure that the bracket is mounted on a solid surface.

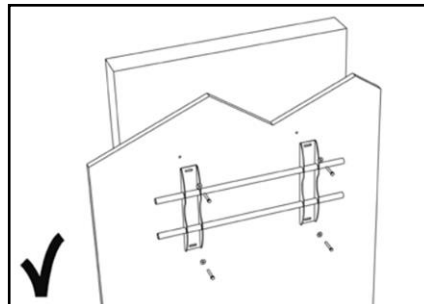
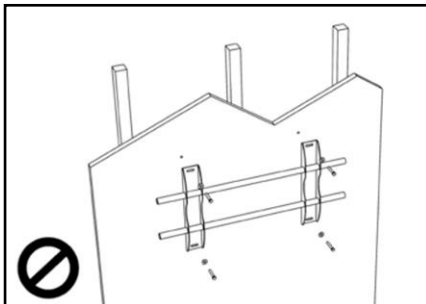

2. After mounting the screen, do not pull, push or shake the screen.

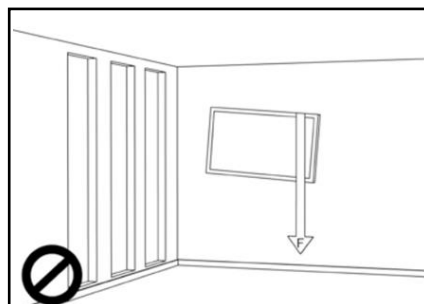
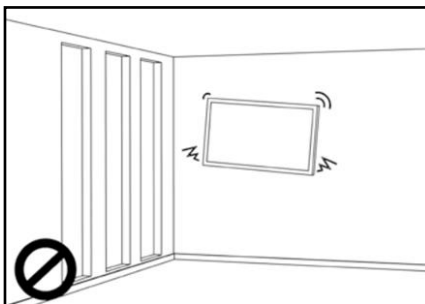

# SAFETY INSTRUCTIONS

1. Do not install screens in direct sunlight, humid conditions, or high temperatures.

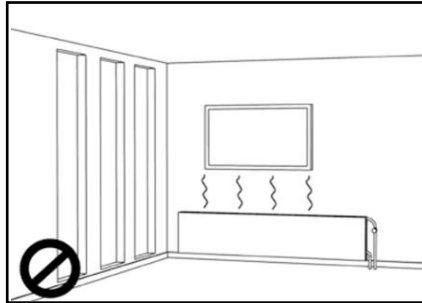
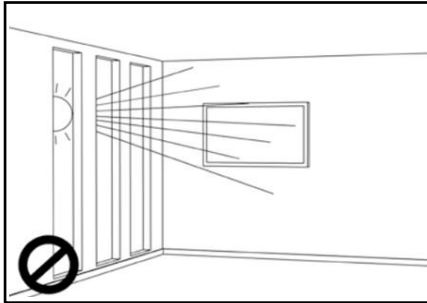

4.

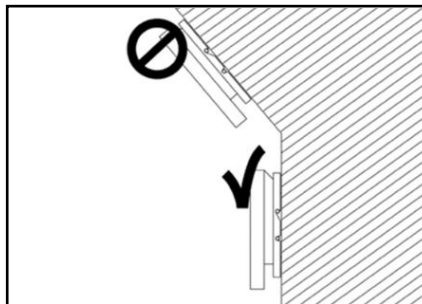
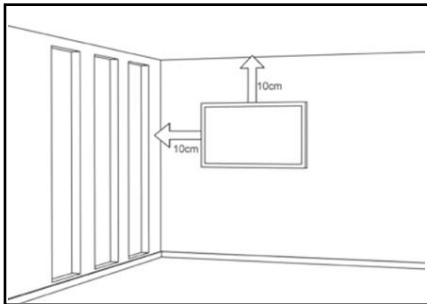

## 2.5 RECOMMENDED USE

If you encounter a problem during installation, please contact your supplier for assistance. Don't repair or open the e-screen by yourself. Failure to do so may result in fire or electrical shock.

Contact your dealer for inspection.

Protect and correctly use the power cord/plug.

- Don't pinch the power cord/plug between hard surfaces.
- Don't step on the power cord/plug.
- Before inserting the power plug into the wall outlet, connect the power cord to the display.
- Using an e-screen with a damaged or non-original power cord can damage the screen, cause fires or electrical shocks.

Using extension cords (not recommended)

If an extension cord must be used, ensure the voltage rating exceeds the max power consumption of the display. If the voltage rating is less than the display, it will cause the extension cord to overheat.

Do not operate the screen during thunder or lightning.

Remove the powerplug from the power outlet.

# SAFETY INSTRUCTIONS

**Don't use any kind of liquid on the e-screen.**

- If liquid is spilled on the e-screen, remove the power plug from the wall socket and ask qualified service personnel to check the product.
- If liquid gets on e-screens glass plate, clean it with a dry and soft cloth immediately.
- Don't use any chemicals on the e-screen.
- If metal or liquids get into the e-screen, it may cause a fire or an electrical shock.

**Don't install or remove the power plug with wet hands.** This may cause an electrical shock.

**If the e-screen will not be used for a long period of time, unplug the display. Preventing to do so may cause premature wear of electrical components or fire.**

**Handle the e-screen with care, prevent glass breakage.**

- If the glass of the e-screen is broken, liquids may escape. Please don't touch the liquid.
- If these liquids come into contact with skin or eyes, immediately wash it away with clean water and consult a medical professional.

**Precautions with the remote-control batteries**

- Please only use approved AAA type batteries.
- Please be sure to insert batteries by matching the + and -.
- Don't recharge, heat, disassemble, short or throw batteries into a fire.
- Don't mix a new battery with a used one.
- Don't mix different types of batteries together (only use the specified type).

## 2.6 CLEANING

Remove the power plug from the power outlet before cleaning.

Failure to do so may result in electrical shock or damage.

Cleaning the surface of the e-screen

- When the surface of the e-screen becomes dirty, wipe the surface lightly with a soft clean cloth.
- If the surface requires additional cleaning, lightly moisten the cloth.
- Do not to let any kind of liquid enter the e-screen as it may cause electrical shock or damage.
- Do not clean the e-screen with alcohol, solvents or ammonia, as this could damage the e-screen.





# Supreme Touchscreen display

## Product Content & Operation

English

Deutsch

Nederlands

Français

Español

## Table of contents

<b>01 PACKAGE CONTENT</b>	<b>11</b>
<b>1.1 UNPACKING</b>	<b>11</b>
<b>1.2 INCLUDED ACCESORIES</b>	<b>11</b>
<b>02 INSTALLATION</b>	<b>11</b>
<b>2.1 ENVIROMENT CONDITIONS</b>	<b>11</b>
<b>2.2 GENERAL OVERVIEW OF THE SCREEN</b>	<b>12</b>
<b>2.3 INPUT / OUTPUT CONNECTOR INFORMATION</b>	<b>13</b>
<b>2.4 REMOTE CONTROL</b>	<b>13</b>
<b>2.4.1 CHANGING THE REMOTE-CONTROL BATTERY</b>	<b>14</b>
<b>03 TURNING THE DISPLAY ON AND OFF</b>	<b>14</b>
<b>3.1 OPERATING THE SCREEN FOR THE FIRST TIME</b>	<b>15</b>
<b>3.2 LAUNCH MENU</b>	<b>16</b>
<b>3.3 SETTINGS MENU</b>	<b>17</b>
<b>3.4 UPDATING THE SCREEN</b>	<b>18</b>
<b>3.5 OPERATING THE SOFTKEY BUTTONS</b>	<b>19</b>
<b>3.6 QUICK SWITCH BUTTON FUNCTIONALITY</b>	<b>19</b>
<b>04 TROUBLESHOOTING</b>	<b>20</b>
<b>05 ACCESSORIES</b>	<b>20</b>
<b>5.1 SUPREME CAMERA</b>	<b>20</b>
<b>5.2 SUPREME SMARTBAR</b>	<b>20</b>

# PACKAGE CONTENT / INSTALLATION

## 1. PACKAGE CONTENT

### 1.1. UNPACKING

- The Touch Monitor is packed using cushions to protect the product during shipping.
- Before unpacking, prepare a stable, level, and clean surface near a wall outlet.
- Step 1: Place the box in an up-right stable position.
- Step 2: Remove the white handles and cut the banding
- Step 3: Smoothly lift the upper part of the box, this will reveal the touch monitor box content
- Step 4: Remove the top cushion and take the accessory bag out.
- Step 5: Extend the bag up and carefully cut the upper layer to unseal the touch monitor bag
- Step 6: Prepare your screen for installation, and then remove it from the box by lifting it.

### 1.2. INCLUDED ACCESORIES.

ITEMS
Power Cord 1.8m
Remote Control
HDMI Cable 1.8m
USB-A/USB-B 3.0 Cable 1.8m
USB-C/USB-C Cable 1.8m
Cable Clip x 7
Stylus x 2

## 2. INSTALLATION

### 2.1 ENVIROMENT CONDITIONS

When operating the screen, ambient room conditions should not exceed the following:

- Operating temperature: -5°C to 45°C (41°F to 104°F)
- Humidity: less than 90% RH (Max)

# OVERVIEW

## 2.2 GENERAL OVERVIEW OF THE SCREEN



# OVERVIEW



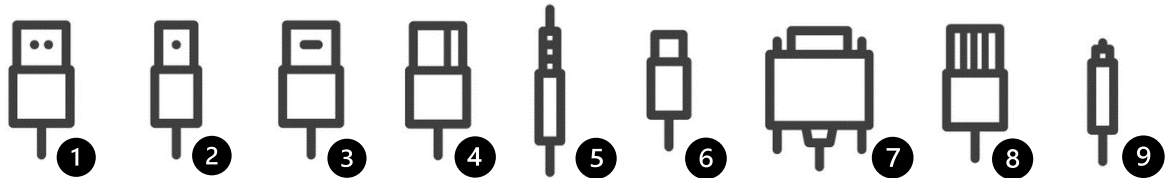





## 2.3 INPUT / OUTPUT CONNECTOR INFORMATION



- 1 USB-A 2.0 (x1) / USB-A 3.0 (x3)
- 2 USB-B 3.0 (x3) / USB-B 3.0 (x1 Touch IN)
- 3 HDMI 2.0 (x3) / HDMI Out (x1)
- 4 DP 1.2 (x1)
- 5 Minijack 3,5 Stereo (x1)
- 6 USB-C
- 7 RS-232 (Serial)
- 8 RJ-45 (x1 IN) / RJ-45 (x1 Out)
- 9 SPDIF (Optical Audio)

## 2.4 REMOTE CONTROL



-  Turn the display ON and OFF.
-  Home: Head directly to the main home page
-  Source Selection Displays the input selection screen to select from
-  Navigation Buttons Easy navigation wheel
-  Select / Confirm: Confirm your on screen selection
-  Back / Return to previous MENU Returns to the previously selected on screen MENU.
-  Volume Down Lowers the audio volume.
-  Volume Up Raises the audio volume.
-  Settings MENU Direct access to the main settings MENU

# OVERVIEW / OPERATING THE SCREEN

## 2.4.1 CHANGING THE REMOTE-CONTROL BATTERY

### 1. Remove the battery cover:

On the backside of the remote-control, slide down the battery cover.

### 2. Insert batteries:

Use two AAA batteries and insert them according to the plus and minus indicators in the remote control.

### 3. Close the battery cover by sliding it back into place.

I. Discard batteries according to the local waste reduction and recovery regulations.

II. Do not keep used, empty batteries in the remote control. They can leak and result in damages to the remote control.

III. Only use batteries according to the instructions and regulations found in this manual and to the instructions and regulations set forth by the batterie's manufacturer.

#### About the remote control

- Do not drop, shake, or bump.
- Avoid moist conditions, liquids, high-temperatures and/or exposure to direct sunlight.
- Don't dismantle.

## 3. TURNING THE DISPLAY ON AND OFF

Please make sure the display is connected to an AC power-socket using the supplied power cable.

Set the AC-switch to "I ". The Touch monitor will start up, if not.

To switch the display on, push the power-button on the screen once, or push the power-button on the remote control.

To switch the monitor off, press the power-button on the screen, or push the power button on the remote control. The display will switch to stand-by mode.

To turn off power completely, turn the AC switch to "O "or disconnect the AC power cord from the power outlet.

# OPERATING THE SCREEN

## 3.1 OPERATING THE SCREEN FOR THE FIRST TIME

When first starting up your screen you will be prompted to set-up some basic options:

**Step 1:** Language

**Step 2:** Time Zone

**Step 3:** Picture Settings

**Step 4:** Ethernet network connection set

**Step 5:** Home Screen Configuration

- **No Home configuration:** This option will disable the main home screen.
  - 1. Center Menu Configuration:** This option 1 will position the main home inputs centered on your screen.
  - 2. Bottom Menu Configuration:** This option 2 will position the main home inputs on the bottom center of your screen.
  - 3. Right side Menu Configuration:** This Option 3 will position the main home inputs on the right side of your main home menu of your screen.

**Step 6:** Customizing your Home Screen.

You will be prompted with a simple menu on which you will be able to modify your home screen inputs and information:

- **Selecting active Inputs:** from a simple toggle option you are able to select the active inputs to be displayed on the home screen. As a default all input will be ON and you will need to select the ones to include in your home screen.
- **Setting Input Logos:** By selecting the active inputs you can customize the specific logo to be shown in order to ease the user experience.
- **Changing Input Names:** You will be able to keep the default names for said active inputs or change them to your liking by tapping on the inputs name to your right.

In case you need to alter this selection after already running the first time set up you can select any other option through the settings menu.

**Step 7:** Select your Quick input sources, you will be prompted with a simple menu from which you can choose your most frequently used inputs to quickly switch between.

**Step 8:** Your configuration is complete, enjoy your screen.

# OPERATING THE SCREEN

## 3.2 LAUNCH MENU

By pushing the Home button on your remote control or Legamaster Logo on your screen once, the Home Screen will open. From this customizable menu, the most used inputs of the screen can quickly be switched.



All this option can be customized and suited to the users needs, changing the amount of direct input access icons, images and names.



# OPERATING THE SCREEN

## 3.3 SETTINGS MENU

MAIN SETTINGS	LEVEL 1	VALUES	EXPLANATION	
Settings	Customization	Source & Home Screen Personalization		Change Active homescreen icons and input names
		Home Source	HDMI 1/ HDMI 2 / HDMI 3 / OPS / DisplayPort / Type-C / Home Screen	Select the Home button source switch
		Quick input 1	HDMI 1/ HDMI 2 / HDMI 3 / OPS / DisplayPort / Type-C / None	Select the Quick Switch Input 1
		Quick Input 2	HDMI 1/ HDMI 2 / HDMI 3 / OPS / DisplayPort / Type-C / None	Select the Quick Switch Input 2
		Homescreen Layout	Option 1/ Option 2/ Option 3 / Homescreen Disabled	Select the homescreen Layout from the given options.
		AutoSense		AutoSense Options and Configurations.
		Auto-Detect	ON/OFF	Turn Auto-Detect ON & OFF.
		AutoLoop	ON/OFF	Turn AutoLoop ON & OFF.
		OSD Time Out	5 sec. / 10 sec. / 20 sec. / 30 sec. / 60 sec. / OFF	Select the OSD time out timer.
		Power	Power ON Input	HDMI 1/ HDMI 2 / HDMI 3 / OPS / DisplayPort / Type-C / Home Screen / Last
	Schedule		ON/OFF	Turn the scheduler on ON & OFF.
	Power ON Time		Time settings	Time set up for the screen to turn ON.
	Power OFF Time		Time settings	Time set up for the screen to turn OFF.
	Scheduled Days		Week Calendar	Select Days on which to apply power timer settings.
	Motion Wake-Up		ON/OFF	Turn Motion Wake-Up ON & OFF.
	Motion Detection		OFF / 5min. / 15 min. / 30 min. / 45 min. / 60 min.	Set Motions Detection timer.
	OPS Power		Auto / Always ON	Set OPS power Settings.
	OPS Boot		ON/OFF	Set OPS to Boot up when the screen does.
	Smart Light Control		ON/OFF	Turn Smart light Control ON & OFF.
	Power Saving Config	ECO / Wake on LAN / Wake on All / Always ON	Select the Power Configuration Options.	
	Picture	Scheme	Standard / Soft / Vivid / Natural / Sports	Select a picture scheme to apply to the screen's picture settings.
		Contrast	0-100	Adjust Contrast Settings.
		Brightness	0-100	Adjust Brightness Settings.
		Sharpness	0-100	Adjust Sharpness Settings.
		Hue	0-100	Adjust Hue.
		Saturation	0-100	Adjust Sturation Settings.
		Backlight	0-100	Adjust the Backlight intensity
		Gamma	OFF / 2.2	Select Gamma Options.
		Color Temperature	9300k / 7500k / 6500k / 5000k	Select Color Temperature.
	HDMI Color Range	Auto / 0-255 / 16-235	Adjust HDMI Color Range	
	Audio	Volume	0-100	Adjust Volume Level.
		Audio Mode	User / Music / Movie / Video Conference	Select the desired Audio Mode
		Treble	-6 - 6	Adjust Treble Settings.
		Bass	-6 - 6	Adjust Bass Settings
		Speaker	ON/OFF	Set Speackers ON & OFF
		Audio Source	Auto / Default / USB Audio	Select the Audio Source to be used.
	System	Model Name		Screen's Model Name
		Version		Screens's Firmware Version
		Serial Number		Screens's Serial Number
		Language	English / Deutsch / Nederlands / Francais / Español	Select the Screens UI Language
		Firmware Update (USB)		Perform a Firmware Update through an USB Drive.
		Firmware Update (OTA)		Perform a Firmware Update using the Over The Air service.
Factory Reset			Perform a factory reset.	

# OPERATING THE SCREEN

MAIN SETTINGS		LEVEL 1	VALUES	EXPLANATION	
Settings	Time & Date	Use Network Time	ON/OFF	Retrieve Time setting from the available network.	
		Date		Set Date	
		Time		Set Time	
		Timezone		Set TimeZone	
		Use 24 Hour Time	ON/OFF	Set clock to use 24 Hour Time	
		Date Format		Select the format on which the Date will be displayed	
	Network and Control	Ethernet	DHCP		Turn DHCP ON/OFF
			IP Address		Displays the Screen's IP Address
			Subnet		Displays the Screen's Subnet
			Gateway		Displays the Screen's Gateway
			DNS 1		Displays the Screen's First DNS
			DNS 2		Displays the Screen's Second DNS
		Ethernet MAC		Displays the Screen's Ethernet Adaptors MAC	
		LAN IP		Displays the Screen's LAN IP	
		Wi-Fi	DHCP		Turn DHCP ON/OFF
			IP Address		Displays the Screen's IP Address
			Subnet		Displays the Screen's Subnet
			Gateway		Displays the Screen's Gateway
			DNS 1		Displays the Screen's First DNS
			DNS 2		Displays the Screen's Second DNS
		Wi-Fi MAC		Displays the Screen's Wi-Fi Adaptors MAC	
		Wi-Fi IP		Displays the Screen's Wi-Fi IP	
		Control Over TCP			
Enable Control over TCP	ON/OFF		Turn Control over TCP ON & OFF.		
TCP Port			TCP Port information.		
RS232 Baud Rate	9600 / 19200 / 38400 / 115200		Select the baud rate to be used.		

## 3.4 UPDATING THE SCREEN

Before first using the screen, please update it to the latest firmware version. Supreme touch monitor can be updated in 2 ways, Over-the-Air (Internet connection required) or using a USB-drive.

To update to the latest firmware version using OTA, open the Quick Launch menu by tapping the menu softkey on the touch monitor. From this menu, click on the Setting option to open the main settings-menu and navigate to System -> Firmware Update (OTA). You will be prompted with a download option if an update is available.

To update to the latest firmware version using a USB Drive, open the Quick Launch menu by tapping the menu softkey on the touch monitor. From this menu, click on the Setting option to open the main settings-menu and navigate to System -> Firmware Update (USB).

# OPERATING THE SCREEN

## 3.5 OPERATING THE SOFTKEYS



- 1. Menu Softkey:** This Softkey will open your Quick launch menu. From this menu you will be able to modify and customize the screen and its content.
- 2. Home Softkey:** This Softkey will take you to the Home screen.
- 3. Quick Switch Softkey:** This Softkey will switch between two pre-selected inputs.

## 3.6 QUICK SWITCH BUTTON FUNCTIONALITY



The Quick Switch button (1) can be configured to switch between two input sources rapidly and easily.

This configuration can be done either following the first time set up steps or configuring it through the main settings options under the “Customization” menu.

As an example you could configure your Quick Switch Input 1 to OPS and Quick Switch input 2 to your AirServer Connect, this will provide the user with a easy and smooth switch between both inputs.

# OPERATING THE SCREEN

## 4. TROUBLESHOOTING

FOR FREQUENTLY ASKED QUESTIONS, PLEASE VISIT: [FAQ.LEGAMASTER.COM](https://faq.legamaster.com)

## 5. ACCESSORIES

### 5.1 SUPREME CAMERA

Enjoy the full Supreme solution with the new Supreme Camera.

You will be able to integrate this camera on top of your screen in an instant and even have the option to rotate and slide it to the side on the 75" and 86" screens.

- **Optical Resolution:** 1920 x 1080
- **Frame Rate:** 30 fps 200 lux
- **Field of View:** 103 (H) x 70 (V)
- **Microphones:** 5ch. Digital, Omnidirectional
- **Microphone Range:** 5m
- **Dimensions (mm):** 183.4 x 93.9 x 57.8



### 5.2 SUPREME SMARTBAR

Enjoy the full Supreme solution with the new Supreme Smartbar.

You will be able to integrate this Smartbar to your Supreme screen and enjoy the best Videoconferencing audio standards and enable the presence sensing solution.

- **Detection Range:** 3.5m +/- 0.5m @120 deg.
- **Detection Frequency:** 2-4 Sec.

