



Owner's Manual IPS LED MONITOR (LED MONITOR*)

*LG LED Monitors are LCD Monitors with LED Backlighting.

Please read the safety information carefully before using the product.

IPS LED Monitor (LED Monitor) Model List

43UD79

43UD79T

CONTENTS

3 LICENSE

4 ASSEMBLING AND PREPARING

- 4 Product Components
- 5 Supported Drivers and Software
- 6 Component and Button Description
 - 6 - How to Use the Joystick Button
- 7 - How to Use the Joystick Button
- 8 Input Connector
- 10 Moving and Lifting the Monitor
- 11 Installing the Monitor
 - 11 - Assembling the stand base
 - 12 - Assembling the stand base
 - 13 - Using the cable holder
 - 14 - Installing onto a table
 - 15 - Adjusting the angle
 - 15 - Using the Kensington lock
 - 16 - Installing the wall mount plate
 - 16 - Installing to a wall

18 REMOTE CONTROL

19 USING THE MONITOR

- 19 Connecting to a PC
 - 19 - HDMI connection
 - 19 - DisplayPort connection
 - 20 - USB-C connection
- 20 Connecting to AV Devices

- 20 - HDMI connection
- 21 Connecting Peripherals
 - 21 - USB Cable connection - PC
- 22 Connecting to External Devices
 - 22 - Connecting Headphones

23 USER SETTINGS

- 23 Activating the Main Menu
 - 23 - Main Menu Features
- 24 User Settings
 - 24 - Menu Settings

29 TROUBLESHOOTING

31 SPECIFICATIONS

- 31 43UD79
- 32 43UD79T
- 33 Factory Support Mode (Preset Mode, PC)
- 33 HDMI
- 34 DisplayPort / USB-C
- 35 HDMI Timing (Video)
- 35 Power LED

36 EXTERNAL CONTROL DEVICE SETUP

- 36 - Communication Parameters
- 36 - Transmission
- 36 - OK Acknowledgement
- 36 - Error Acknowledgement
- 37 - Command Reference List

LICENSE

Each model has different licenses. Visit www.lg.com for more information on the license.



The terms HDMI and HDMI High-Definition Multimedia Interface, and the HDMI logo are trademarks or registered trademarks of HDMI Licensing LLC in the United States and other countries.



VESA, VESA logo, DisplayPort compliance logo and DisplayPort compliance logo for dual-mode source devices are all registered trademarks of the Video Electronics Standards Association.



The SuperSpeed USB Trident logo is a registered trademark of USB Implementers Forum, Inc.

The following content is only applied to the monitor which is sold in Europe market and which needs to meet the ErP Directive:

* This monitor is set to be turned off automatically in 4 hours after you turned on display if there is no adjustment to display.

* To make this setting be disabled, change the option to 'Off' in OSD menu of "Automatic Standby".

ASSEMBLING AND PREPARING

Product Components

Please check whether all the components are included in the box before using the product. If there are missing components, contact the retail store where you purchased the product. Note that the product and components may look different from those shown here.



CD(Owner's Manual) / Card



Power Cord
(Depending on the country)

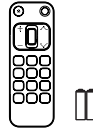

Remote control, Batteries (AAA)

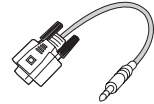

RS-232C Gender
(This gender is not included in all countries.)

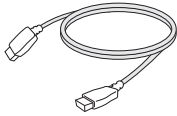

HDMI Cable
(This cable is not included in all countries.)

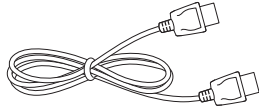

DisplayPort Cable
(This cable is not included in all countries.)

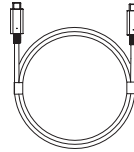

USB C-C cable
(This cable is not included in all countries.)

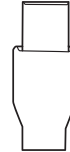

USB C-A Gender
(This gender is not included in all countries.)

43UD79

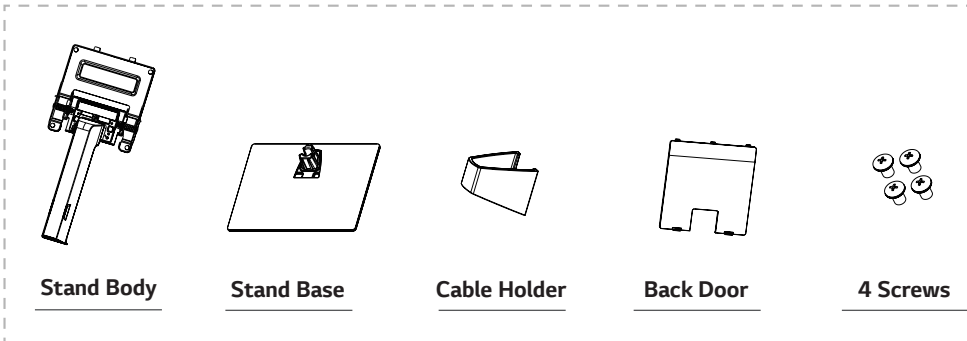

Stand Body

Stand Base

Cable Holder

Back Door

4 Screws

43UD79T

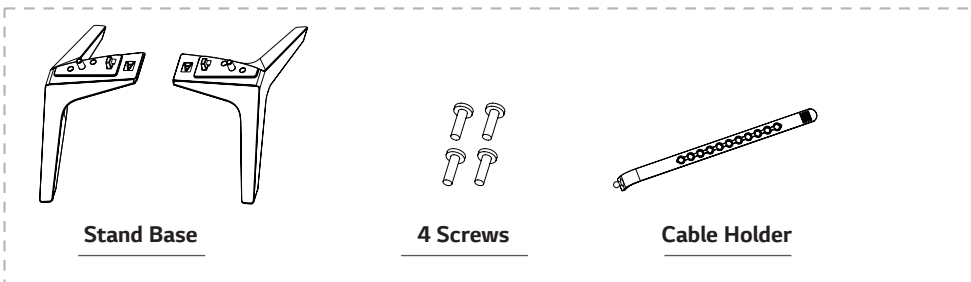

Stand Base

4 Screws

Cable Holder

**CAUTION**

- Always use genuine components to ensure safety and product performance.
- The product warranty will not cover damage or injury caused by the use of counterfeit components.
- It is recommend that use the supplied components.
- If you use generic cables not certified by LG, the screen may not display or there may be image noises.

**NOTE**

- Note that the components may look different from those shown here.
- Without prior notice, all information and specifications in this manual are subject to change to improve the performance of the product.
- To purchase optional accessories, visit an electronics store or online shopping site or contact the retail store where you purchased the product.

Supported Drivers and Software

Check the drivers and software supported by your product and refer to the manuals on the CD enclosed in the product package.

Drivers and Software	Installation Priority	43UD79,43UD79T
Monitor Driver	Recommended	0
On Screen Control	Recommended	0
Dual Controller	Optional	0

- Required and Recommended: You can download and install the latest version from the enclosed CD or from the LGE website (www.lg.com).
- Optional: You can download and install the latest version from the LGE website (www.lg.com).

Component and Button Description



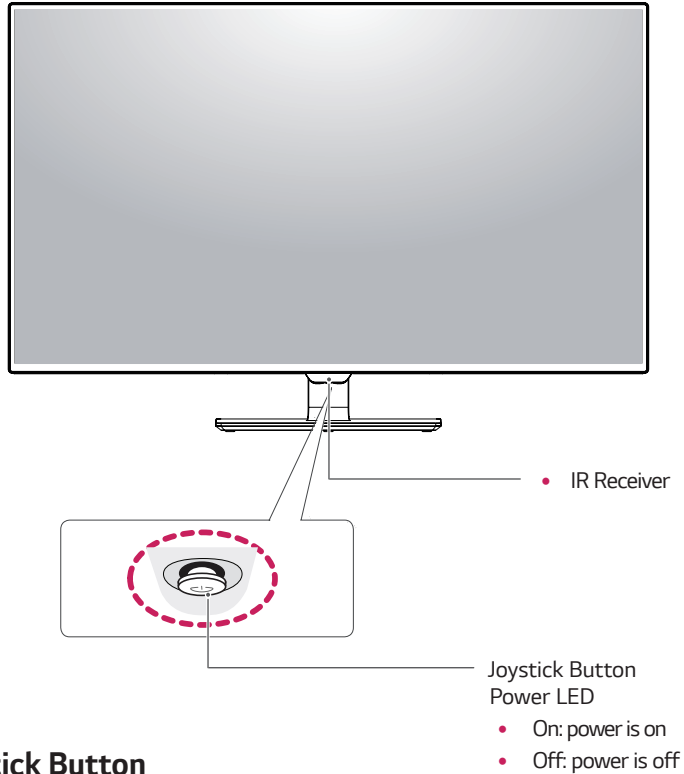

43UD79



How to Use the Joystick Button

You can easily control the functions of the monitor by pressing the joystick button or moving it left/right with your finger.

Basic Functions

		Power on	Press the joystick button once with your finger to turn on the monitor.
		Power off	Press and hold the joystick button once with your finger to turn off the monitor.
		Volume Control	You can control the volume by moving the joystick button left/right.

NOTE

- The joystick button is located at the bottom of the monitor.

43UD79T

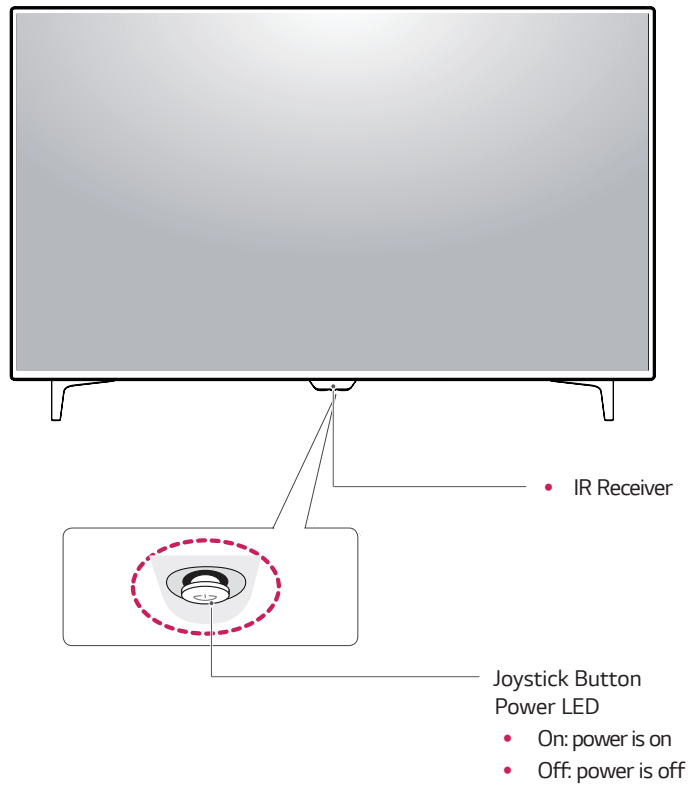

How to Use the Joystick Button

You can easily control the functions of the monitor by pressing the joystick button or moving it left/right with your finger.

Basic Functions

		Power on	Press the joystick button once with your finger to turn on the monitor.
		Power off	Press and hold the joystick button once with your finger to turn off the monitor.
		Volume Control	You can control the volume by moving the joystick button left/right.

NOTE

- The joystick button is located at the bottom of the monitor.

Input Connector

43UD79

ENGLISH

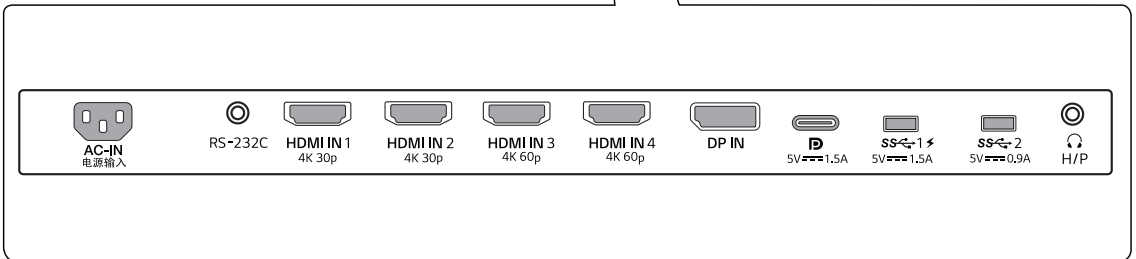
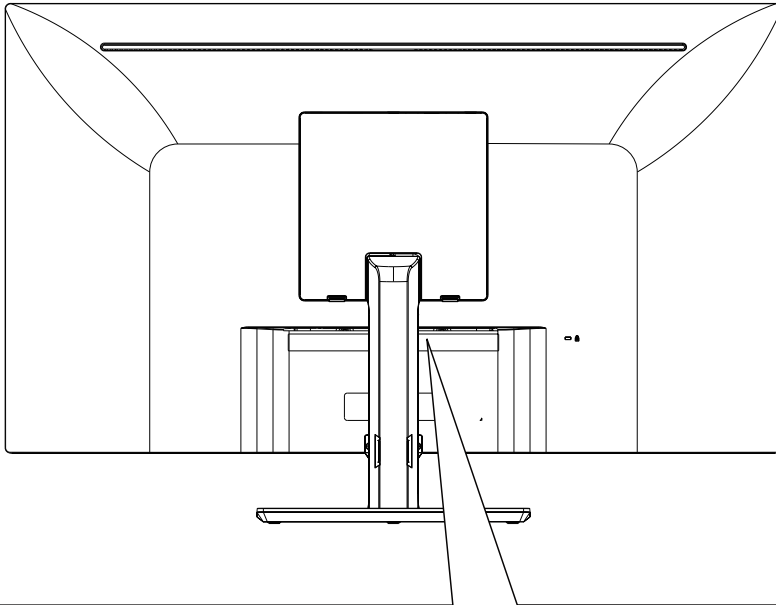

43UD79T

ENGLISH

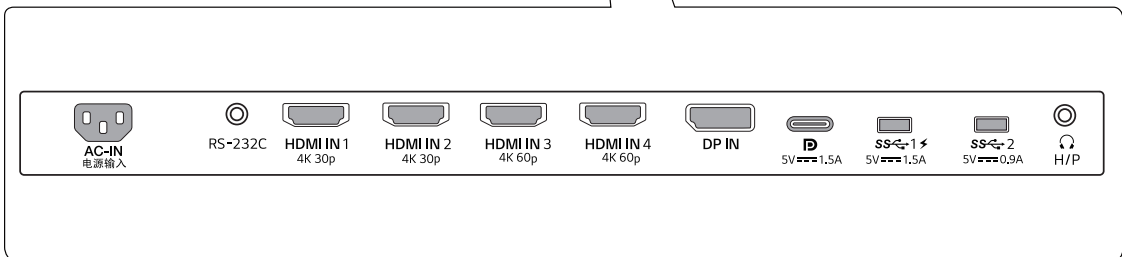
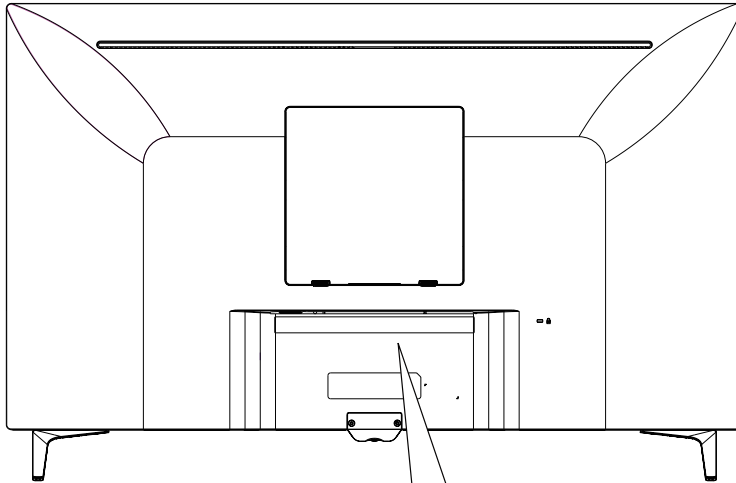

Moving and Lifting the Monitor

When moving or lifting the monitor, follow these instructions to prevent the monitor from being scratched or damaged and to ensure safe transportation regardless of its shape or size.

- It is advisable to place the monitor in the original box or packing material before attempting to move it.
- Before moving or lifting the monitor, disconnect the power cord and all cables.
- Hold the top and bottom of the monitor frame firmly. Do not hold the screen itself.

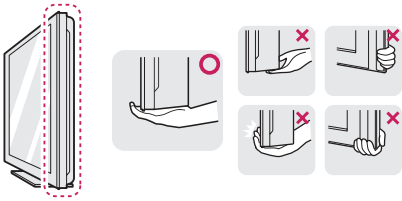

- When holding the monitor, the screen should face away from you to prevent it being scratched.

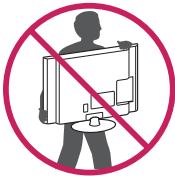

- When moving the monitor, avoid any strong shock or vibrations to the product.
- When moving the monitor, keep it upright, never turn the monitor on its side or tilt it sideways.

CAUTION

- As far as possible, avoid touching the monitor screen. This may result in damage to the screen or some of the pixels used to create images.

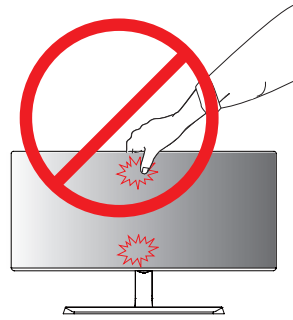

Or

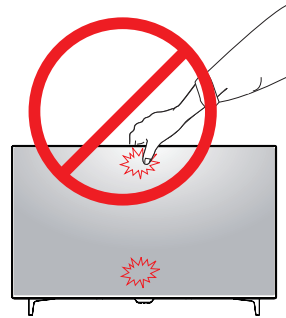

- If you use the monitor panel without the stand base, its joystick button may cause the monitor to become unstable and fall, resulting in damage to the monitor or human injury. In addition, this may cause the joystick button to malfunction.

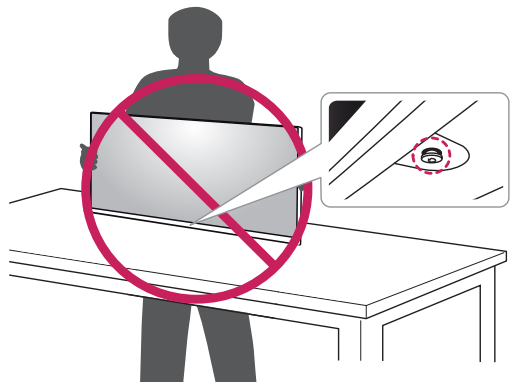

Installing the Monitor

Assembling the stand base

43UD79

- 1 Please put a soft cloth on a low table or box to protect the screen of the monitor.

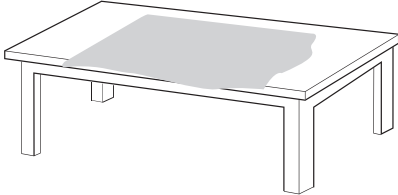

- 2 Please put the monitor on the soft cloth with the screen facing down.

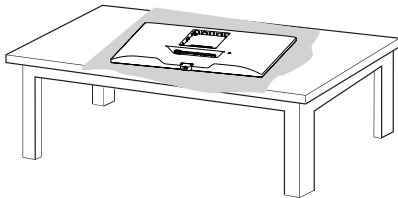

- 3 **1** Assemble the **Head** and **Stand body**.
2 Assemble the **Stand body** and **Stand base**.

Turn the screw clockwise to secure the **stand base**.

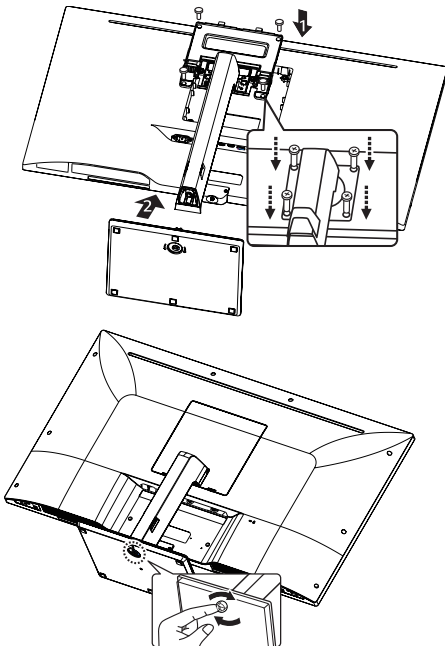

- 4 Assemble the **Head** and **Back door**.

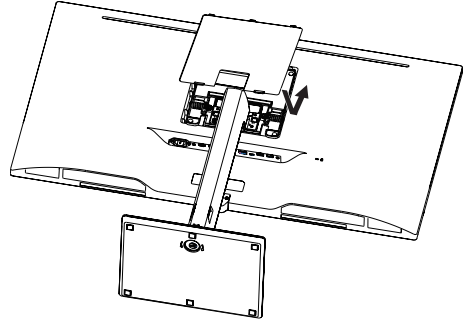

CAUTION

- To avoid injury to the fingers and foot when Assembly **Stand Body** and **Base**, should hold **Base** when assembly stand body and base.
- Do not apply foreign substances (oils, lubricants, etc.) to the screw parts when assembling the product.
(Doing so may damage the product.)



Assembling the stand base

43UD79T

- 1 Please put a soft cloth on a low table or box to protect the screen of the monitor.

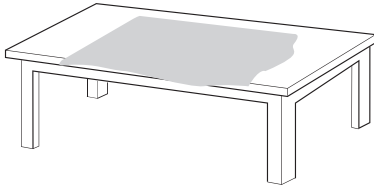

- 2 Please put the monitor on the soft cloth with the screen facing down.

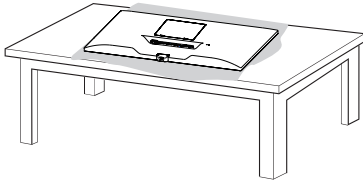

- 3 Assemble the **Stand base** and **Head**.
Turn the screw clockwise to secure the **stand base**.

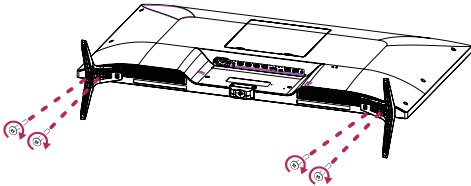

CAUTION

- To avoid injury to the fingers and foot when Assembly **Stand Body** and **Base**, should hold Base when assembly stand body and base.
- Do not apply foreign substances (oils, lubricants, etc.) to the screw parts when assembling the product.
(Doing so may damage the product.)



**CAUTION**

- Illustrations in this document represent typical procedures, so they may look different from the actual product.
- Do not carry the monitor upside down by just holding the stand base. This may cause the monitor to fall off the stand and could result in personal injury.
- When lifting or moving the monitor, do not touch the monitor screen. The force applied to the monitor screen may cause damage to it.
- Do not apply foreign substances (oils, lubricants, etc.) to the screw parts when assembling the product. (Doing so may damage the product.)
- Applying excessive force when tightening screws may cause damage to the monitor. Damage caused in this way will not be covered by the product warranty.

**NOTE**

- You can disassemble the stand in the reverse order of the assembly.

Using the cable holder

Arrange the cables using the cable holder as shown in the illustration.

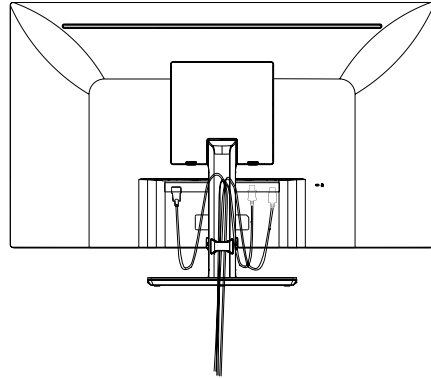
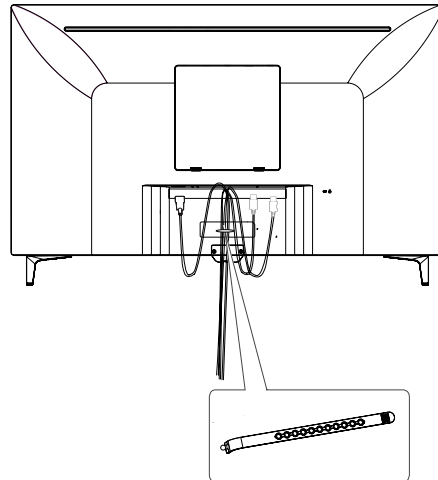
43UD79**43UD79T****Cable Holder**

Installing onto a table

- 1 Lift the monitor and place it on the table in an upright position.

Place at least **100 mm** away from the wall to ensure sufficient ventilation.

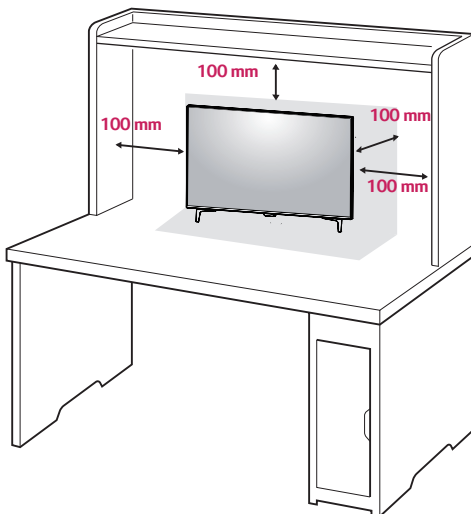
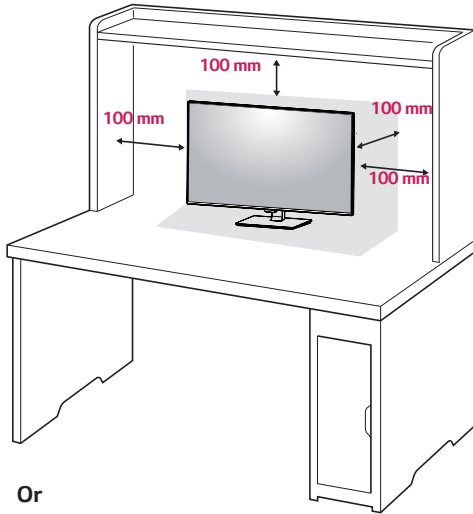

- 2 Connect the Power cord to the monitor, then plug the power cord into the wall outlet.

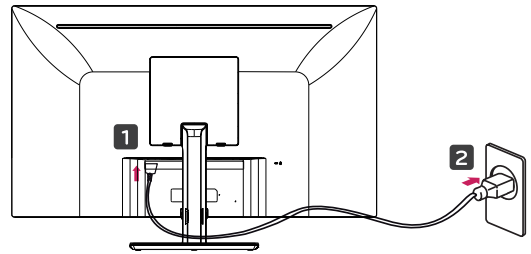

Or

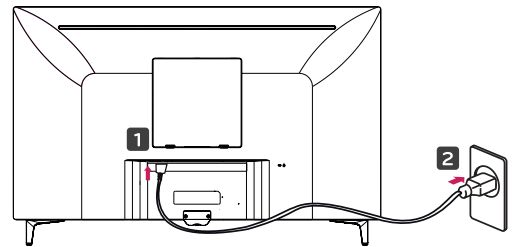

- 3 Press the joystick button on the bottom of the monitor to turn on the monitor.

CAUTION

- Unplug the power cord prior to moving or installing the monitor. There is risk of electric shock.

Cautions When Connecting Power Cord

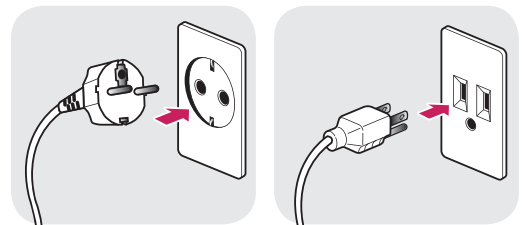

100-240 V~

- Make sure to use the power cord that is provided in the product package and connect it to a grounded power outlet.
- If you need another power cord, please contact your local dealer or the nearest retail store.

Adjusting the angle

- 1 Place the monitor in an upright position, mounted on the stand base.
- 2 Adjust the angle of the screen. The angle of the screen can be adjusted forwards or backwards for a comfortable viewing experience.

43UD79

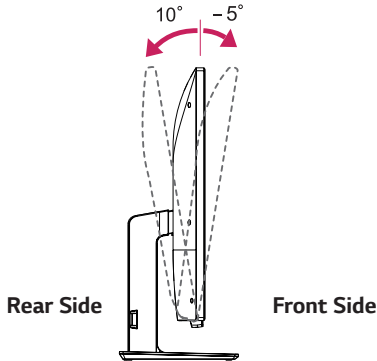

! WARNING

- To avoid injury to the fingers when adjusting the screen, do not hold the lower part of the monitor's frame as illustrated below.

43UD79

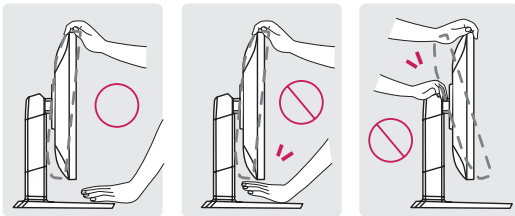

- Be careful not to touch or press the screen area when adjusting the angle of the monitor.

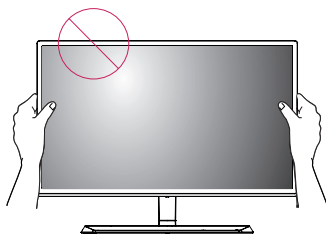

Or

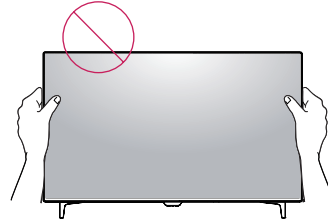

Using the Kensington lock

The Kensington security system connector is located at the back of the Monitor set.

For more information on installation and usage, refer to the Kensington lock user manual or visit the website at <http://www.kensington.com>.

Connect the Kensington security system cable between the Monitor set and a table.

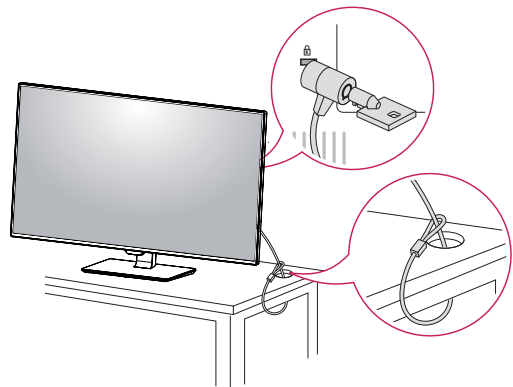

Or

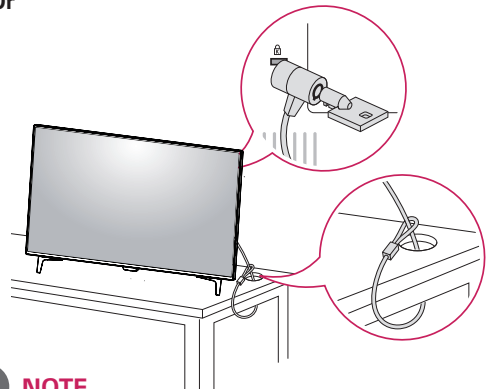

! NOTE

- Use of the Kensington lock is optional. The accessories can be purchased at your local electronics store.

Installing the wall mount plate

This monitor supports the specification of the standard wall mount plate or compatible device.

- 1 Place the screen face down. To protect the screen from scratches, cover the surface with a soft cloth.
- 2 Place the wall mount plate onto the monitor and align it with the screw holes.
- 3 Tighten the four screws to fix the plate to the monitor using a screwdriver.



NOTE

- The wall mount plate is sold separately.
- For more information on installation, refer to the wall mount plate's installation guide.
- Be careful not to use excessive force when mounting the wall mount plate, as this can damage the monitor's screen.

Installing to a wall

Install the monitor at least 100 mm away from the wall and leave about 100 mm of space at each side of the monitor to ensure sufficient ventilation. Detailed installation instructions can be obtained from your local retail store. Please refer to the manual to install and set up a tilting wall mounting bracket.

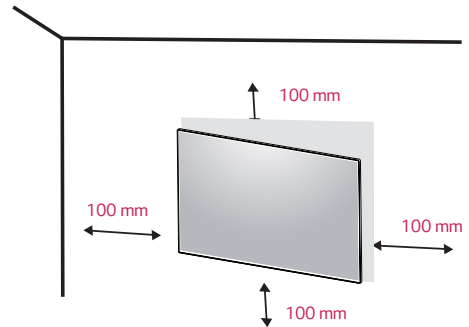

To install the monitor to a wall, attach a wall mounting bracket (optional) to the back of the monitor. Make sure that the wall mounting bracket is securely fixed to the monitor and to the wall.

- 1 If you use screw longer than standard, the monitor might be damaged internally.
- 2 If you use improper screw, the product might be damaged and drop from mounted position.
In this case, LG Electronics is not responsible for it.

Wall Mount (A x B)	200 x 200
Standard screw	M6
Number of screws	4
Wall Mount Plate (Optional)	LSW240B

- Wall Mount (A x B)

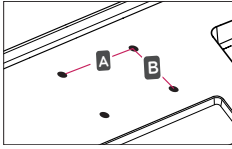

CAUTION

- Unplug the power cord before moving or installing the monitor to avoid electric shocks.
- Installing the monitor on the ceiling or on a slanted wall may result in the monitor falling off, which could lead to injury. Please use the genuine LG wall mounting bracket. For more information, contact your local retail store or a qualified installer.
- Applying excessive force when fastening screws may cause damage to the monitor. Damage caused in this way will not be covered by the product warranty.
- Use the wall mounting bracket and screws that conform to the VESA standard. Damage caused by the use or misuse of inappropriate components will not be covered by the product warranty.



NOTE

- Use the screws specified by the VESA standard.
- The wall mount kit includes the installation guide and all necessary parts.
- The wall mounting bracket is optional. The accessories can be purchased at your local retail store.
- The length of the screw may differ for each wall mounting bracket. Ensure the correct length screw is used.
- For more information, please refer to the user manual for the wall mounting bracket.

REMOTE CONTROL

The descriptions in this manual are based on the buttons on the remote control. Please read this manual carefully to use the monitor correctly.





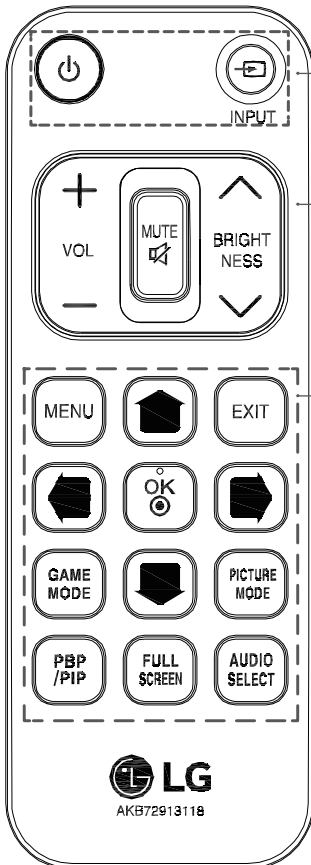
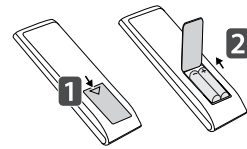

To install batteries, open the battery cover, place batteries (1.5 V AAA) matching ⊕ and ⊖ terminals to the labels inside the compartment, and close the battery cover.

To remove the batteries, perform the installation actions in reverse. The illustrations may differ from the actual accessories.

 **CAUTION**

- Do not mix old and new batteries, as this may damage the remote control.
- Be sure to point the remote control toward the remote control sensor on the monitor.
- The GAME MODE and PICTURE MODE are disabled when PBP/PIP on



<p> (POWER) Turns the monitor on or off.</p> <p> INPUT Selects the input mode.</p>
<p>Volume Up/Down Button Adjusts the volume.</p> <p>MUTE Mutes all sounds.</p> <p>BRIGHTNESS Adjust the brightness by pressing the Up and Down buttons on the remote control.</p>
<p>MENU Configures the screen setting</p> <p> /  /  / </p> <p>Configures the options by moving the up/down/left/right button</p> <p>EXIT Exits the main menu</p> <p>OK Selects menus or options and confirms your input.</p> <p>GAME MODE Enters the Game features.</p> <p>PICTURE MODE Selects the picture mode</p> <p>PBP/PIP Change PBP/PIP mode</p> <p>FULL SCREEN Converts the sub screen in PBP/PIP mode to wide screen.</p> <p>AUDIO SELECT Change the audio output in PBP/PIP mode</p>

USING THE MONITOR

Connecting to a PC

- This monitor supports the *Plug and Play feature.
*Plug and Play: A feature that allows you to add a device to your computer without having to reconfigure anything or install any manual drivers.

HDMI connection

Transmits the digital video and audio signals from your PC and A/V devices to the monitor. Connect your PC and AV device to the monitor with the HDMI cable as illustrated below.

Press the menu button and then select the input option from the input menu.

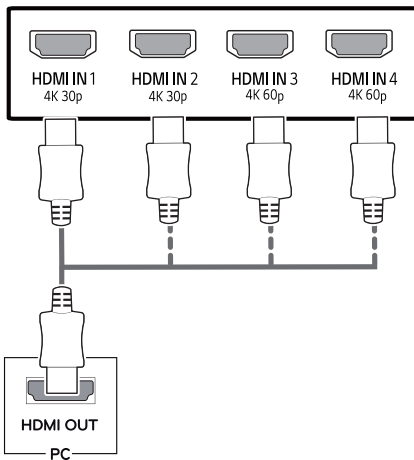

! NOTE

- If you use HDMI PC, it can cause compatibility problem.
- Use a certified cable with the HDMI logo attached. If you do not use a certified HDMI cable, the screen may not display or a connection error may occur.
- Recommended HDMI cable types
 - High-Speed HDMI[®]/™ Cable
 - High-Speed HDMI[®]/™ Cable with Ethernet
 - HDMI 1/2 only support 4K@30Hz
 - HDMI 3/4 can support 4K@60Hz

DisplayPort connection

Transmits the digital video and audio signals from your PC to the monitor. Connect your PC to the monitor using the DisplayPort cable as illustrated below.

Press the menu button and then select the input option from the input menu.

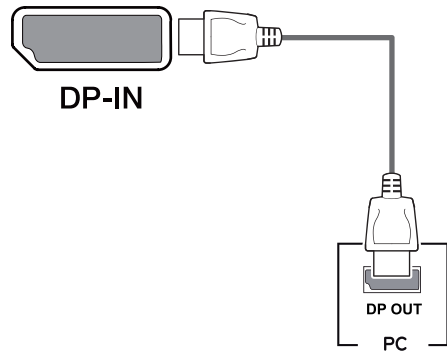

! NOTE

- There may be no video or audio output depending on the DP version of the PC.
- If you use generic cables not certified by LG, the screen may not display or there may be image noises.

USB-C connection

Transmits digital video and audio signals from your PC to the monitor.

Connect the monitor to your PC using the USB C-C cable as shown in the illustration below. Press the menu button and then select the input option from the input menu.

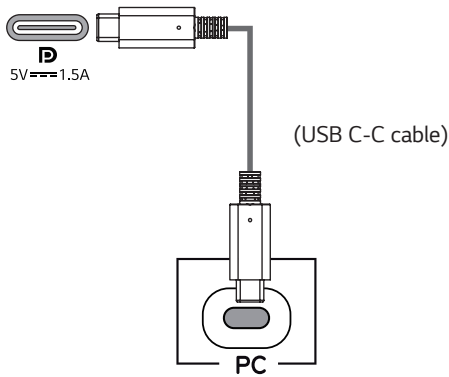

NOTE

- PD(Power Delivery) and DP Alternate Mode(DP over USB-C) are supported via USB-C Port.
- Features may not work properly depending on the connected device's specifications and the environment.
- USB-C port is not for the Monitor Power source but for a PC power source. Connect Adapter to supply power to the Monitor

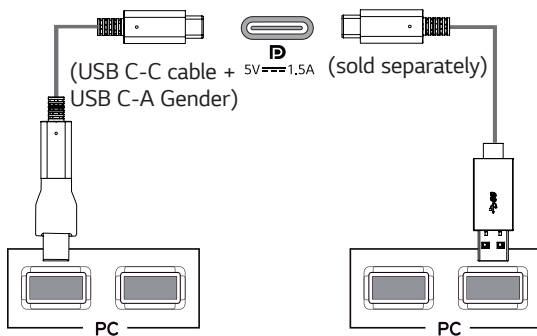

Connecting to AV Devices

HDMI connection

Transmits the digital video and audio signals from your PC and A/V devices to the monitor. Connect your PC and AV device to the monitor with the HDMI cable as illustrated below.

Press the menu button and then select the input option from the input menu.

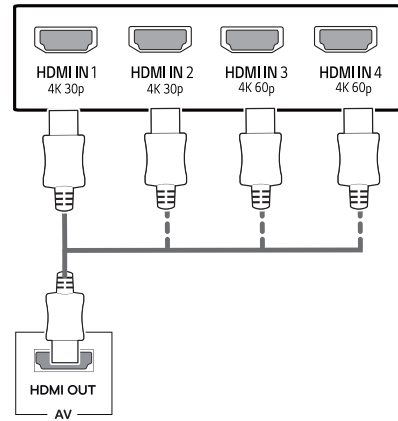

NOTE

- Use a certified cable with the HDMI logo attached. If you do not use a certified HDMI cable, the screen may not display or a connection error may occur.
- Recommended HDMI cable types
 - High-Speed HDMI[®]/TM Cable
 - High-Speed HDMI[®]/TM Cable with Ethernet
 - HDMI 1/2 only support 4K@30Hz
 - HDMI 3/4 can support 4K@60Hz

Connecting Peripherals

USB Cable connection - PC

The USB port on the product functions as a USB hub. Please connect the USB C-C cable to the PC.

NOTE

- Make sure to install the most recent Windows OS service pack before using the product.
- Peripheral devices are sold separately.
- A keyboard, mouse, or USB device can be connected to the USB port.
- **Quick Charge** is available through the USB1 port.
- The charging speed may vary depending on the device.

- The items supplied with your product may vary depending on the model.
- Product specifications or contents of this manual may be changed without prior notice due to upgrade of product functions.
- For an optimal connection, HDMI cables and USB devices should have bezels less than 10 mm thick and 18 mm width.
- Use an extension cable that supports USB2.0 or 3.0 if the USB cable or USB memory stick does not fit into Your Monitor USB port.

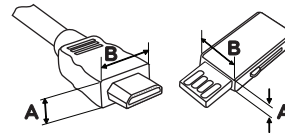

*A ≤ 10 mm

*B ≤ 18 mm

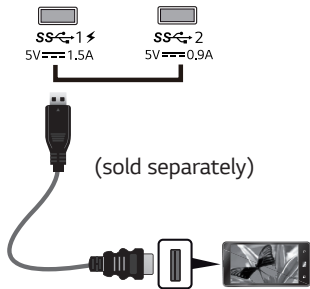

- Use a certified cable with the HDMI logo attached. If you do not use a certified HDMI cable, the screen may not display or a connection error may occur.
- Recommended HDMI cable types
 - High-Speed HDMI®/™ cable
 - High-Speed HDMI®/™ cable with Ethernet

CAUTION

Cautions When Using a USB Device

- A USB device with an automatic recognition program installed, or that uses its own driver, may not be recognized.
- Some USB devices may not be supported or may not work properly.
- It is recommended to use a USB hub or hard disk drive with power supplied. (If the power supply is not adequate, the USB device may not be recognized properly.)
- If the USB C-C cable is not connected with Host PC, monitor may not support 'Charge'.

Connecting to External Devices

Connecting Headphones

Connect peripherals to the monitor via the headphones port. Connect as illustrated.

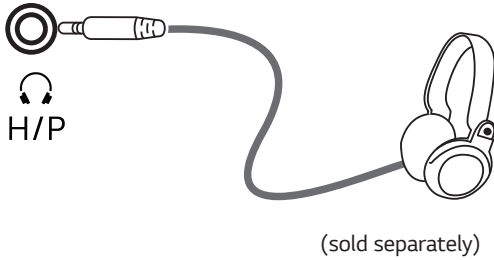

! NOTE

- Peripheral devices are sold separately.
- If you use angled earphones, it may cause a problem with connecting another external device to the monitor. Therefore, it is recommended to use straight earphones.



Angled



Straight



- Depending on the audio settings of the PC and external device, headphones and speaker functions may be limited.

USER SETTINGS

Activating the Main Menu

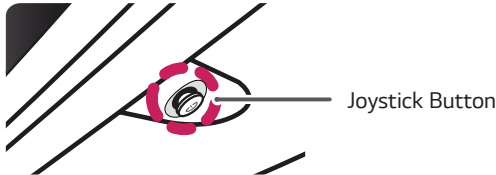
- 1 Press the joystick button on the bottom of the monitor.
- 2 Move the joystick up/down (▲/▼) and left/right(◀/▶) to set the options.
- 3 Press the joystick button once more to exit the main menu.



Button	Menu Status	Description
	Main menu disabled	Enables the main menu.
	Main menu enabled	Exits the main menu. (Holding down the button to turn off the monitor. You can turn off the monitor this way at any time, including when the OSD is on.)
	◀ Main menu disabled	Adjusts the monitor volume level.
	◀ Main menu enabled	Enters the Input feature.
	▶ Main menu disabled	Adjusts the monitor volume level.
	▶ Main menu enabled	Enters the Menu features.
	▲ Main menu disabled	Displays information on the current input.
	▲ Main menu enabled	Turns off the monitor.
	▼ Main menu disabled	Displays information on the current input.
	▼ Main menu enabled	Enters the Game features.

Main Menu Features



Main Menu	Description
Menu	Configures the screen settings.
Game Mode	You can change Picture Mode to a gaming mode.
Input	Sets input mode.
Power Off	Turns off the monitor.
Exit	Exits the main menu.

User Settings

Menu Settings

- 1 To view the OSD menu, press the joystick button at the bottom of the monitor and then enter the Menu.
- 2 Configure the options by moving the joystick up/down/left/right.
- 3 To return to the upper menu or set other menu items, move the joystick to ◀ or pressing (⊙ / Ok) it.
- 4 If you want to exit the OSD menu, move the joystick to ◀ until you exit.
 - When you enter the menu, instructions on how to use the button will appear in the bottom right corner of the screen.



Quick Settings



Input



Picture



General



CAUTION

- Your monitor's OSD (On Screen Display) may differ slightly from that shown in this manual.

Each option is described below.

Menu > Quick Settings	Description
Brightness	Adjusts the color contrast and brightness of the screen.
Contrast	
Volume	Adjusts the volume level. <div style="margin-top: 10px;"> NOTE <ul style="list-style-type: none"> • You can adjust Mute / Unmute by moving the joystick button to ▼ in the Volume menu. </div>

[PBP/PIP OFF]

Menu > Input	Description	
Input List	Selects the input mode.	
Aspect Ratio	Adjusts the aspect ratio of the screen.	
	Full Wide	Displays the video in wide-screen, regardless of the video signal input.
	Original	Displays video according to the aspect ratio of the video signal input.
	1:1	The aspect ratio is not adjusted from the original.
	NOTE <ul style="list-style-type: none"> • The display may look the same for Full Wide , Original, and 1:1 options at the recommended resolution (3840 x 2160). 	
Underscan	Reduce the display area	
PBP/PIP	You can select the various PBP or PIP combination.	

[PBP/PIP ON]

Menu > Input	Description		
Input List	Displays the screens of main input and sub input		
Aspect Ratio	Adjusts the aspect ratio of the screen.		
	Main input	Full Wide	Displays the video to fit the PBP/PIP screen, regardless of the video signal input.
		Original	Displays the video in the aspect ratio of the video signal input on the PBP/PIP screen.
	Sub input	Full Wide	Displays the video to fit the PBP/PIP screen, regardless of the video signal input.
Original		Displays the video in the aspect ratio of the video signal input on the PBP/PIP screen.	
Underscan	Reduce the display area		
PBP/PIP	You can select the various PBP or PIP combination		
PIP Size	Sets the size of the PIP Sub window. (Small/Medium/Large)		
Transparency	Sets the opacity of PIP		
Sound Out	Select the audio output in PBP/PIP mode		

**NOTE**



- If not using the **PBP/PIP** feature, **PIP Size**, **Transparency** and **Sound Out** are deactivated.

Each option is described below.



Menu > Picture	Description	
Picture Mode	Custom	Allows the user to adjust each element. The color mode of the main menu can be adjusted.
	Reader	Optimizes the screen for viewing documents. You can brighten the screen in the OSD menu.
	Photo	Optimizes the screen for photos.
	Cinema	Optimizes the screen for video.(This mode raises vividness when use the Set-top Box.)
	Dark Room 1	This mode adjusts the brightness to the optimal level for working in a dark environment.
	Dark Room 2	This mode sets the brightness to a lower level than Dark Room 1.
	Color Weakness	This mode is for users who cannot distinguish between red and green. It enables users with color weakness to easily distinguish between the two colors.
	FPS Game 1	This mode is optimized for FPS games.
	FPS Game 2	It has a higher Black Stabilizer value than FPS Game 1. It is suitable for very dark FPS games.
	RTS Game	This mode is optimized for RTS Game.
Custom (Game)	In this mode, users can customize various elements including game-related options.	

**NOTE**

- If the **picture mode** is changed in the DP (DisplayPort) input, the screen may flicker or the resolution of your PC screen may be affected.

Picture Adjust	Brightness	Adjusts the brightness of the screen.			
	Contrast	Adjusts the contrast of the screen.			
	Sharpness	Adjusts the sharpness of the screen.			
	SUPER RESOLUTION+	High	Optimized picture quality is displayed when a user wants crystal clear images. It is effective for high quality video or game.		
		Middle	The optimized picture quality is displayed when a user wants images between low and high modes for comfortable viewing. It is effective for UCC or SD video.		
		Low	The optimized picture quality is displayed when a user wants smooth and natural images. It is effective for slow-moving pictures or still images.		
		Off	Select this option for everyday viewing. SUPER RESOLUTION+ is turned off in this mode.		
		 NOTE		<ul style="list-style-type: none"> Because this is a function to increase the sharpness of low resolution pictures, it is not recommended to use the function for normal text or for desktop icons. Doing so may result in unnecessarily high sharpness. 	
	Black Level	Sets the offset level (for HDMI only). <ul style="list-style-type: none"> Offset: as a reference for a video signal, this is the darkest color the monitor can display. 			
		High	Keeps the current contrast ratio of the screen.		
		Low	Lowers the black levels and raises the white levels from the current contrast ratio of the screen.		
	HDMI ULTRA HD Deep Color	Provides sharper images when connected to a device supporting ULTRA HD Deep Color.			
		4K@60 Hz Support Format¹⁾			
		Resolution	Frame rate (Hz)	Color Depth / Chroma Sampling	
				8 bit	10 bit
3840 x 2160		59.94 60.00	YCbCr 4:2:0		
			YCbCr 4:4:4	-	
			RGB 4:4:4	-	
1) Supported when HDMI ULTRA HD Deep Color is set to On.					
 NOTE		<ul style="list-style-type: none"> If the connected device does not support ULTRA HD Deep Color, the feature may not work properly. If a problem occurs, set the HDMI ULTRA HD Deep Color option to Off. 			
DFC	On	Adjusts the brightness automatically according to the screen.			
	Off	Disables the DFC feature.			
Game Adjust	Response Time	Sets a response time for displayed pictures based on the speed of the screen. For a normal environment, it is recommended that you use Normal . For a fast-moving picture, it is recommended that you use Fast . Setting to Fast may cause image sticking.			
		Fast	Sets the response time to Fast.		
		Normal	Sets the response time to Normal.		
		Slow	Sets the response time to Slow.		
		Off	Does not use the response time improvement feature.		
	Black Stabilizer	You can control the black contrast to have better visibility in dark scenes. Increasing the Black Stabilizer value brightens the low gray level area on the screen. (You can easily distinguish objects on dark game screens.) Reducing the Black Stabilizer value darkens the low gray level area and increases the dynamic contrast on the screen.			

Color Adjust	Gamma	Mode 1, Mode 2, Mode 3	The higher the gamma value, the darker the image becomes. Likewise, the lower the gamma value, the lighter the image becomes.
		Mode 4	If you do not need to adjust the gamma settings, select Mode 4.
		Color Temp	Custom
		Warm	Sets the screen color to a reddish tone.
		Medium	Sets the screen color between a red and blue tone.
		Cool	Sets the screen color to a bluish tone.
	Red	You can customize the picture color using Red , Green , and Blue colors.	
	Green		
	Blue		
	Six Color	Meets the user requirements for colors through adjusting the color and saturation of the six colors(Red_Hue, Red_Saturation, Green_Hue, Green_Saturation, Blue_Hue, Blue_Saturation, Cyan_Hue, Cyan_Saturation, Magenta_Hue, Magenta_Saturation, Yellow_Hue, Yellow_Saturation) and saving the settings.	
	Hue	Adjusts the tone of the screen colors.	
	Saturation	Adjusts the saturation of the screen colors. The lower the value, the less saturated and brighter the colors become. The higher the value, the more saturated and darker the colors become.	
Picture Reset	Do you want to reset your settings?		
	Yes	Returns to the default settings.	
	No	Cancel the select.	

Menu > General	Description	
Language	Sets the menu screen to the desired language.	
Sound Optimizer	Allows optimized sound for individual Monitor installation.	
	Stand Type	Optimized sound for a stand-mounted Monitor.
	Wall Mount Type	Optimized sound for a wall-mounted Monitor.
SMART ENERGY SAVING	High	Saves energy using the high-efficiency SMART ENERGY SAVING feature.
	Low	Saves energy using the low-efficiency SMART ENERGY SAVING feature.
	Off	Disables the SMART ENERGY SAVING feature.
Set ID	You can choose the Set ID 01~Set ID 10	
Power LED	Turns the power LED on the bottom of the monitor on or off.	
	On	The power LED turns on automatically.
	Off	The power LED turns off.
Automatic Standby	Feature that automatically turns off the monitor when there is no movement on the screen for a period of time. You can set a timer for the auto-off function. (Off, 4 H, 6 H, and 8 H)	
DisplayPort 1.2	Enables or disables DisplayPort 1.2.	
	 NOTE <ul style="list-style-type: none"> Be sure to configure this option according to the DisplayPort version supported by your graphics card. Set this option to Disable if your graphics card does not support DisplayPort 1.2. 	
Buzzer	This feature lets you set the sound generated from Buzzer when your monitor powers on.	
	On	Enables your monitor's Buzzer .
	Off	Disables your monitor's Buzzer .
Quick Charge	Quick Charge is a feature that rapidly charges the device connected to the USB 1 port.	
	On	Enables Quick Charge .
	Off	Disables Quick Charge .
OSD Lock	This feature disables the configuration and adjustment of menus.	
	On	Enables OSD Lock.
	Off	Disables OSD Lock.
	 NOTE <ul style="list-style-type: none"> All features are disabled except Brightness, Contrast, Volume, Input, OSD Lock in General and the Exit button. 	
OSD Size	User can select OSD Size to Large or Small.	
Reset	Do you want to reset your settings?	
	Yes	Returns to the default settings.
	No	Cancel the select.

 **NOTE**

- Saving Data depends on the Panel. So, these values may be different from each panel and/or panel vendor. If the SMART ENERGY SAVING option is High or Low, monitor luminance become higher or lower depending on the source.

TROUBLESHOOTING

Nothing is displayed on the screen.	
Is the monitor's power cord plugged in?	<ul style="list-style-type: none"> Check if the power cord is correctly plugged into the power outlet.
Is the power LED on?	<ul style="list-style-type: none"> Check the power cable connection and press the power button.
Is the power on and the power LED displaying white?	<ul style="list-style-type: none"> Check that the connected input is enabled (Menu > Input > Input list).
Is the OUT OF RANGE message being displayed?	<ul style="list-style-type: none"> This occurs when signals transferred from the PC (graphics card) are out of the horizontal or vertical frequency range of the monitor. Please see the Product Specification section of this manual to set the appropriate frequency.
Is the No Signal message being displayed?	<ul style="list-style-type: none"> This is displayed when the signal cable between the PC and the monitor is missing or disconnected. Check the cable and reconnect it.

The OSD lock message is being displayed.	
Are some functions not available when you press the Menu button?	<ul style="list-style-type: none"> The OSD is locked. Go to Menu > General and set OSD Lock to Off.

The screen retains an image.	
Does image sticking occur even when the monitor is turned off?	<ul style="list-style-type: none"> Displaying a still image for a prolonged time may cause damage to the screen, resulting in the retention of the image. To extend the lifetime of the monitor, use a screensaver.

Screen display is unstable and shaky / Images displayed on the monitor leave shadow trails.	
Did you select the appropriate resolution?	<ul style="list-style-type: none"> If the selected resolution is HDMI 1080i 60/50 Hz (interlaced), the screen may be flickering. Change the resolution to 1080P or the recommended resolution.

NOTE

- Vertical frequency** In order to display an image, the screen must be refreshed dozens of times per second, like a fluorescent lamp. The number of times the screen is refreshed per second is called vertical frequency, or refresh rate, and is represented by Hz.
- Horizontal frequency** The time it takes to display one horizontal line is called the horizontal cycle. If 1 is divided by the horizontal interval, the result is the number of horizontal lines displayed per second. This is called horizontal frequency and is represented by kHz.
- LED can be lighted with Set OSD Menu.

Menu – General – Power LED – On

**NOTE**

- Check if the graphics card's resolution or frequency is within the range allowed by the monitor and set it to the recommended (optimal) resolution in **Control Panel > Display > settings**.
- Not setting the graphics card to the recommended (optimal) resolution may result in blurred text, a dimmed screen, a truncated display area, or misalignment of the display.
- The setting methods may be different depending on the computer or operating system, and some resolutions may not be available depending on the performance of the graphics card. If this is the case, contact the manufacturer of the computer or graphics card for assistance.
- Some graphics cards may not support 3840 x 2160 resolution. If the resolution cannot be displayed, contact the manufacturer of your graphics card.

The display color is abnormal.	
Does the display appear discolored (16 colors)?	<ul style="list-style-type: none"> • Set the color to 24 bit (true color) or higher. In Windows, go to Control Panel > Display > Settings > Color Quality.
Does the display color appear unstable or monochrome?	<ul style="list-style-type: none"> • Check if the signal cable is connected properly. Reconnect the cable or reinsert the PC's graphics card.
Are there spots on the screen?	<ul style="list-style-type: none"> • When using the monitor, pixilated spots (red, green, blue, white, or black) may appear on the screen. This is normal for an LCD screen. It is not an error, nor is it related to the monitor's performance.

Do you see an "Unrecognized monitor, Plug&Play (VESA DDC) monitor found" message?	
Have you installed the display driver?	<ul style="list-style-type: none"> • Be sure to install the display driver from the display driver CD (or diskette) that comes with your display. Or, you can also download the driver from our web site: http://www.lg.com. • Make sure to check if the video card supports Plug&Play function.

No sound from the headphone port or speaker.	
Are images displayed using DisplayPort or HDMI input without sound?	<ul style="list-style-type: none"> • Try increasing the volume using the button on the monitor. • Set the audio output of the PC to the monitor you are using. On Microsoft Windows, go to Control Panel > Hardware and Sound > Sound > set the monitor as default device.

SPECIFICATIONS

43UD79

LCD Screen	Type	TFT (Thin Film Transistor) LCD (Liquid Crystal Display) Screen
	Pixel Pitch	0.2451 mm x 0.2451 mm
Resolution	Maximum Resolution	HDMI IN 1/2 : 3840 x 2160 @ 30 Hz HDMI IN 3/4 : 3840 x 2160 @ 60 Hz DP IN (USB-C IN) : 3840 x 2160 @ 60 Hz
	Recommended Resolution	HDMI IN 1/2 : 3840 x 2160 @ 30 Hz HDMI IN 3/4 : 3840 x 2160 @ 60 Hz DP IN (USB-C IN) : 3840 x 2160 @ 60 Hz
Video Signal	Horizontal Frequency	30 kHz to 135 kHz
	Vertical Frequency	56 Hz to 61 Hz
Input Connector	HDMI1,2,3,4, DP(DisplayPort) IN, H/P, USB-C, USB (SS↔) 1/2, RS-232C	
Power input	100 - 240 V~ 50/60 Hz 1.5 A	
Power consumption (Typ.)	On mode: 70 W Typ. (Outgoing condition)* Sleep Mode ≤ 0.5 W Off Mode ≤ 0.3 W	
Environmental Conditions	Operating Condition	Temperature: 0°C to 40°C; Humidity: < 80%
	Storing Condition	Temperature: -20°C to 60°C; Humidity: < 85%
Dimension	Monitor Size (Width x Height x Depth)	
	With Stand	967 mm x 647.6 mm x 275 mm
	Without Stand	967 mm x 575.2 mm x 70.6 mm
Weight (Without Packaging)	With Stand	15.9 kg
	Without Stand	12.3 kg

The specifications are subject to change without notice.

* The power consumption level can be different by operating condition and monitor setting.

* The On mode power consumption is measured with LGE test standard (Full White pattern, Maximum resolution).

43UD79T

LCD Screen	Type	TFT (Thin Film Transistor) LCD (Liquid Crystal Display) Screen
	Pixel Pitch	0.2451 mm X 0.2451 mm
Resolution	Maximum Resolution	HDMI IN 1/2 : 3840 x 2160 @ 30 Hz HDMI IN 3/4 : 3840 x 2160 @ 60 Hz DP IN (USB-C IN) : 3840 x 2160 @ 60 Hz
	Recommended Resolution	HDMI IN 1/2 : 3840 x 2160 @ 30 Hz HDMI IN 3/4 : 3840 x 2160 @ 60 Hz DP IN (USB-C IN) : 3840 x 2160 @ 60 Hz
Video Signal	Horizontal Frequency	30 kHz to 135 kHz
	Vertical Frequency	56 Hz to 61 Hz
Input Connector	HDMI1,2,3,4, DP(DisplayPort) IN, H/P, USB-C, USB (SS) 1/2, RS-232C	
Power input	100 - 240 V~ 50/60 Hz 1.5 A	
Power consumption (Typ.)	On mode: 70 W Typ. (Outgoing condition)* Sleep Mode ≤ 0.5 W Off Mode ≤ 0.3 W	
Environmental Conditions	Operating Condition	Temperature: 0°C to 40°C; Humidity: < 80%
	Storing Condition	Temperature: -20°C to 60°C; Humidity: < 85%
Dimension	Monitor Size (Width x Height x Depth)	
	With Stand	967 mm x 624.1 mm x 233 mm
	Without Stand	967 mm x 575.2 mm x 70.6 mm
Weight (Without Packaging)	With Stand	13.0 kg
	Without Stand	12.8 kg

The specifications are subject to change without notice.

* The power consumption level can be different by operating condition and monitor setting.

* The On mode power consumption is measured with LGE test standard (Full White pattern, Maximum resolution).

Factory Support Mode (Preset Mode, PC)

HDMI

Display Modes (Resolution)	Horizontal Frequency(kHz)	Vertical Frequency(Hz)	Polarity(H/V)	Remarks
640 x 480	31.469	59.94	-/-	
800 x 600	37.879	60.317	+/+	
1024 x 768	48.363	60	-/-	
1152 x 864	54.347	60.05	+/+	
1280 x 720	45	60	+/+	
1280 x 1024	63.981	60.02	+/+	
1600 x 900	60	60	+/+	
1920 x 1080	67.5	60	+/-	
2560 x 1440	88.79	59.95	+/-	
3840 x 2160	67.5	30	+/-	
3840 x 2160	135	60	+/-	When HDMI ULTRA HD Deep Color is set to ON.

DisplayPort / USB-C

Display Modes (Resolution)	Horizontal Frequency(kHz)	Vertical Frequency(Hz)	Polarity(H/V)	Remarks
640 x 480	31.469	59.94	-/-	
800 x 600	37.879	60.317	+/+	
1024 x 768	48.363	60	-/-	
1152 x 864	54.347	60.05	+/+	
1280 x 720	45	60	+/+	
1280 x 1024	63.981	60.02	+/+	
1600 x 900	60	60	+/+	
1920 x 1080	67.5	60	+/-	
2560 x 1440	88.79	59.95	+/-	
3840 x 2160	66.66	30	+/-	
3840 x 2160	133.32	60	+/-	

HDMI Timing (Video)

Factory support mode (Preset Mode)	Horizontal Frequency(kHz)	Vertical Frequency(Hz)	Remarks
480p	31.5	60	
720p	45.0	60	
1080p	67.5	60	
2160p	135	60	When HDMI ULTRA HD Deep Color is set to ON.

Power LED

Mode	LED Color
On Mode	White (For a few seconds)
Sleep Mode	Off
Off Mode	Off

EXTERNAL CONTROL DEVICE SETUP

Communication Parameters

Baud rate : 9600 bps (UART)
Data length : 8 bits
Parity : None
Stop bit : 1 bit
Communication code : ASCII code
Use a crossed (reverse) cable.

Transmission

[Command1][Command2][][Set ID][][Data][Cr]

- * [Command 1] : First command to control the Monitor.
- * [Command 2] : Second command to control the Monitor.
- * [Set ID] : You can adjust the set ID to choose desired monitor ID number in optionmenu.
Adjustment range is 1 ~ 10.
When selecting Set ID '0', every connected set is controlled.
Set ID is indicated as decimal (1~10) on menu and as Hexa decimal (0x0-0x0A) on transmission/receiving protocol.
- * [DATA] : To transmit command data.
- * [Cr] : Carriage Return
ASCII code '0x0D'
- * [] : ASCII code 'space (0x20)'

[Command1][Command2][][Set ID][][Data][Cr]

OK Acknowledgement

[Command2][][Set ID][][OK][Data][x]

* The Monitor transmits ACK (acknowledgement) based on this format when receiving normal data. At this time, if the data is in data read mode, it indicates present status data. If the data is in data write mode, it returns the data of the PC computer.

Error Acknowledgement

[Command2][][Set ID][][NG][Data][x]

* The Monitor transmits ACK (acknowledgement) based on this format when receiving abnormal data from nonviable functions or communication errors.

Command Reference List

Title	Command 1	Command 2	Data(Hex)
Power	k	a	00 ~ 01
Screen Mute	k	d	00 ~ 01
Input select (Main)	x	b	00 ~ FF
Input select (Sub)	x	c	00 ~ FF
Input select (Sub2)	x	d	00 ~ FF
Input select (Sub3)	x	e	00 ~ FF
Aspect Ratio (Main)	x	f	00 ~ 02
Aspect Ratio (Sub)	x	g	00 ~ 01
Aspect Ratio (Sub2)	x	h	00 ~ 01
Aspect Ratio (Sub3)	x	i	00 ~ 01
PBP/PIP	k	n	00 ~ 09
PIP Size	k	p	00 ~ 02
Main/Sub Screen Change	m	a	01
Picture Mode	d	x	00 ~ 14
Brightness	k	h	00 ~ 64
Contrast	k	g	00 ~ 64
Sharpness	k	k	00 ~ 64
Brightness Stabilization	m	b	00 ~ 01
SUPERRESOLUTION+	m	c	00 ~ 03
BlackLevel	m	d	00 ~ 01
HDMIULTRAHD DeepColor	m	e	00 ~ 01
DFC	m	f	00 ~ 01
Response Time	m	g	00 ~ 03
Black Stabilizer	m	h	00 ~ 64
Uniformity	m	i	00 ~ 01
Gamma	m	j	00 ~ 09
Color Temp	k	u	00 ~ 04
Red Gain	j	w	00 ~ 64
Green Gain	j	y	00 ~ 64
Blue Gain	j	z	00 ~ 64
Language	f	i	00 ~ 10
SMART ENERGY SAVING	m	k	00 ~ 02
LED Control Button	m	l	00 ~ 03
DVI Power Supply	m	m	00 ~ 01
Auto Screen Off	m	n	00 ~ 01
DisplayPort1.2	m	o	00 ~ 01
OSDLock	k	m	00 ~ 01
Reset	f	k	00 ~ 01

Title	Item
Power	00: Power Off, 01: Power On
Screen Mute	00: Screen Mute Off, 01: Screen Mute On
Input select (Main)	90:HDMI1, 91:HDMI2, 92:HDMI3, 93:HDMI4, C0:DP, E0:USB-C
Input select (Sub)	90:HDMI1, 91:HDMI2, 92:HDMI3, 93:HDMI4, C0:DP, E0:USB-C
Input select (Sub2)	90:HDMI1, 91:HDMI2, 92:HDMI3, 93:HDMI4, C0:DP, E0:USB-C
Input select (Sub3)	90:HDMI1, 91:HDMI2, 92:HDMI3, 93:HDMI4, C0:DP, E0:USB-C
Aspect Ratio (Main)	00:Full Wide, 01:Original, 02: "1 : 1", 03:Cinema1, 04:Cinema2
Aspect Ratio (Sub)	00:Full Wide, 01:Original
Aspect Ratio (Sub2)	00:Full Wide, 01:Original
Aspect Ratio (Sub3)	00:Full Wide, 01:Original
PBP/PIP	00:OFF, 01:PBP, 02:PBP2, 03:PIP_LT, 04:PIP_RT, 05:PIP_LB, 06:PIP_RB,07:PBP_3P(NA), 08:PBP_L1P_R2P(NA), 09:PBP_4P
PIP Size	00:Small, 01:Medium, 02:Large
Main/Sub Screen Change	01: Main/Sub Screen exchange
Picture Mode	00:custom, 01:mono, 02:Reader, 04:Photo, 05:Cinema, 06:sRGB, 07:Color Weakness, 08:Game, 09:FPS Game1, 0A:FPS Game2, 0B:RTS Game, 0C:Custom Game, 0D:EBU, 0E:REC 709, 0F:SMPTE C, 10:DICOM, 11:Calibration1, 12:Calibration2, 13:DarkRoom1, 14:DarkRoom2,
Brightness	0 ~ 64 (Hex) ※ Auto Brightness : Backlight Stabilization On
Contrast	0 ~ 64 (Hex)
Sharpness	0 ~ 64 (Hex)
Brightness Stabilization	00: Off, 01: On
SUPERRESOLUTION+	00: High, 01:Middle, 02:Low, 03:Off
BlackLevel	00:High, 01:Low
HDMIULTRAHD DeepColor	00: On, 01: Off
DFC	00: On, 01: Off
Response Time	00:Fast, 01:Normal, 02:Slow, 03:Off
Black Stabilizer	0 ~ 64 (Hex)
Uniformity	00: On, 01: Off
Gamma	00:Mode4, 01:Mode1, 02:Mode2, 03Mode3, 04:Gamma 1.8, 05:Gamma 2.0, 06:Gamma 2.2, 07:Gamma 2.4, 08:Gamma 2.6, 09:DICOM Gamma
Color Temp	00:Manual, 01:Custom, 02:WARM, 03:MEDIUM, 04:COOL
Red Gain	0 ~ 64 (Hex)
Green Gain	0 ~ 64 (Hex)
Blue Gain	0 ~ 64 (Hex)
Language	00:Eng, 01:Ger, 02:Fre, 03:Spa, 04:Ita, 05:Swe, 06:Fin, 07:Por, 08:Bra, 09:Pol, 0A:Rus, 0B:Grc, 0C:Ukr, 0D:Chi, 0E:ChiT, 0F:Jap, 10:Kor
SMART ENERGY SAVING	00:High, 01:Low, 02:Off
LED Control Button	00:Always On, 01:20sec Time out, 02:10sec Time out, 03:5sec Time out
DVI Power Supply	00: On, 01: Off
Auto Screen Off	00: On, 01: Off
DisplayPort 1.2	00:Enable, 01:Disable,
OSD Lock	00: Off, 01: On
Reset	00: Picture Reset, 01:Factory Reset

 **NOTE**

- Some commands are not supported according to model.



Declaration of Conformity

Trade Name: LG

Model : 43UD79, 43UD79T

Responsible Party: LG Electronics Inc.

Address : 1000 Sylvan Ave. Englewood Cliffs

NJ 07632 U.S.A

TEL: 201-266-2534

*above information is only for USA FCC Regulatory

This device meets the EMC requirements for home appliances (Class B) and is intended for home usage. This device can be used in all regions. Read the owner's manual (CD) carefully and keep it at hand. Please note that the label attached to the product provides information for technical support.

MODEL _____

SERIAL _____