



OWNER'S MANUAL

IPS LED COMPUTER MONITOR (LED COMPUTER MONITOR*)

*Disclaimer: LG LED Monitor applies LCD screen with LED backlights.
This product is a computer monitor and not for television purpose.

Please read the safety information carefully before using the product.

IPS LED Monitor (LED Monitor) Model List

27MB85Z

27MB85R

CONTENTS

3 LICENSE

4 ASSEMBLING AND PREPARING

- 4 Product Composition
- 5 Component and Button Description
- 6 Moving and Lifting the Monitor
- 7 Installing the Monitor
 - 7 - Assembling the Stand Base
 - 8 - Detaching the Stand Base
 - 8 - Installing on a Table
 - 9 - Adjusting the Stand Height
 - 10 - Adjusting the Angle
 - 10 - Tidying Cables
 - 11 - Pivot Feature
 - 12 - Using the Kensington Lock
 - 12 - Detaching the Stand Body
 - 13 - Installing the Wall Mount Plate
 - 13 - Installing on the Wall

15 USING THE MONITOR

- 15 Connecting to a PC
 - 15 - HDMI Connection
 - 16 - DVI Connection
 - 16 - DisplayPort Connection
 - 17 - Thunderbolt (⚡) Connection
- 17 Connecting Peripherals
 - 17 - USB Cable Connection - PC
 - 18 - Headphone Port Connection

19 INSTALLING LG MONITOR SOFTWARE

22 CUSTOMIZING SETTINGS

- 22 Activating the Main Menu
- 23 Customizing Settings
 - 23 - Menu Settings
 - 24 - Ratio Settings
 - 25 - Super Energy Saving (SES) Settings
 - 26 - Mode Settings
 - 27 - PIP settings
 - 29 - Picture
 - 30 - Color
 - 31 - Settings

32 TROUBLESHOOTING

34 SPECIFICATIONS

- 36 Factory Support Mode (Preset Mode PC)
- 36 HDMI Timing (Video)
- 36 Power Indicator

37 PROPER POSTURE

LICENSE

Each model has different licenses. Visit www.lg.com for more information on the license.



The terms HDMI and HDMI High-Definition Multimedia Interface, and the HDMI logo are trademarks or registered trademarks of HDMI Licensing LLC in the United States and other countries.



VESA, VESA logo, Display Port Compliance Logo and Display Port Compliance Logo for dual-mode source are all registered trademarks of the Video Electronics Standards Association.

ASSEMBLING AND PREPARING

Product Composition

Please check whether all the components are included in the box before using the product. If there are missing components, contact the retail store where you purchased the product. Note that the product and components may look different from those shown here.

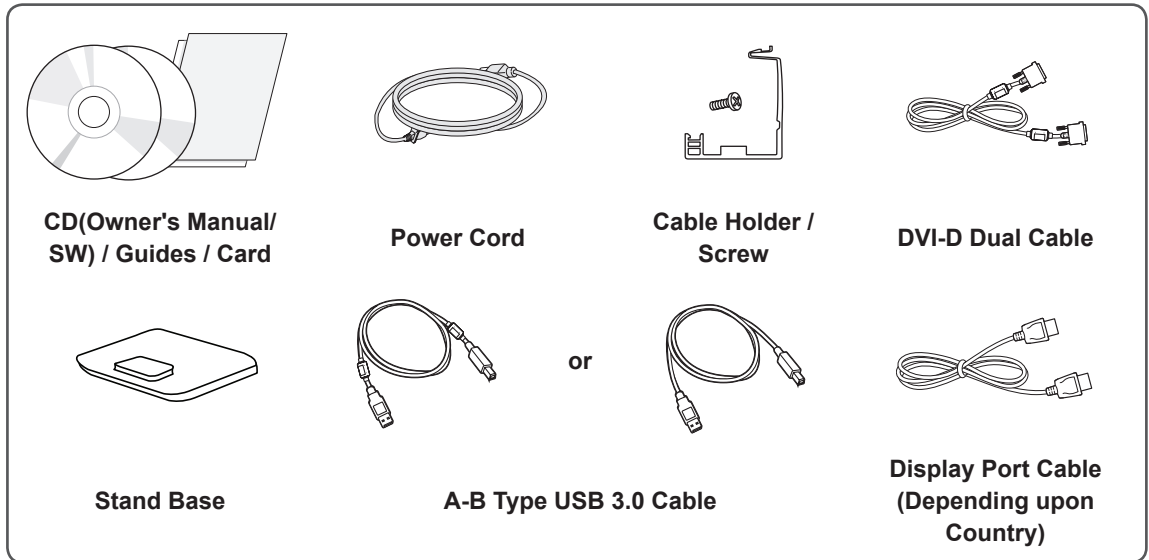

Separate Purchase

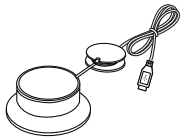

**Calibrator
(ACB8300)**
(Depending upon
Country)



CAUTION

- Always use genuine components to ensure safety and product performance.
- The product warranty will not cover damage or injury caused by the use of unauthorized components.



NOTE

- Note that the components may look different from those shown here.
- Without prior notice, all information and specifications in this manual are subject to change to improve the performance of the product.
- Separate purchase are not included for all models. To purchase optional accessories, visit an electronics store or online shopping site or contact the retail store where you purchased the product.

Component and Button Description

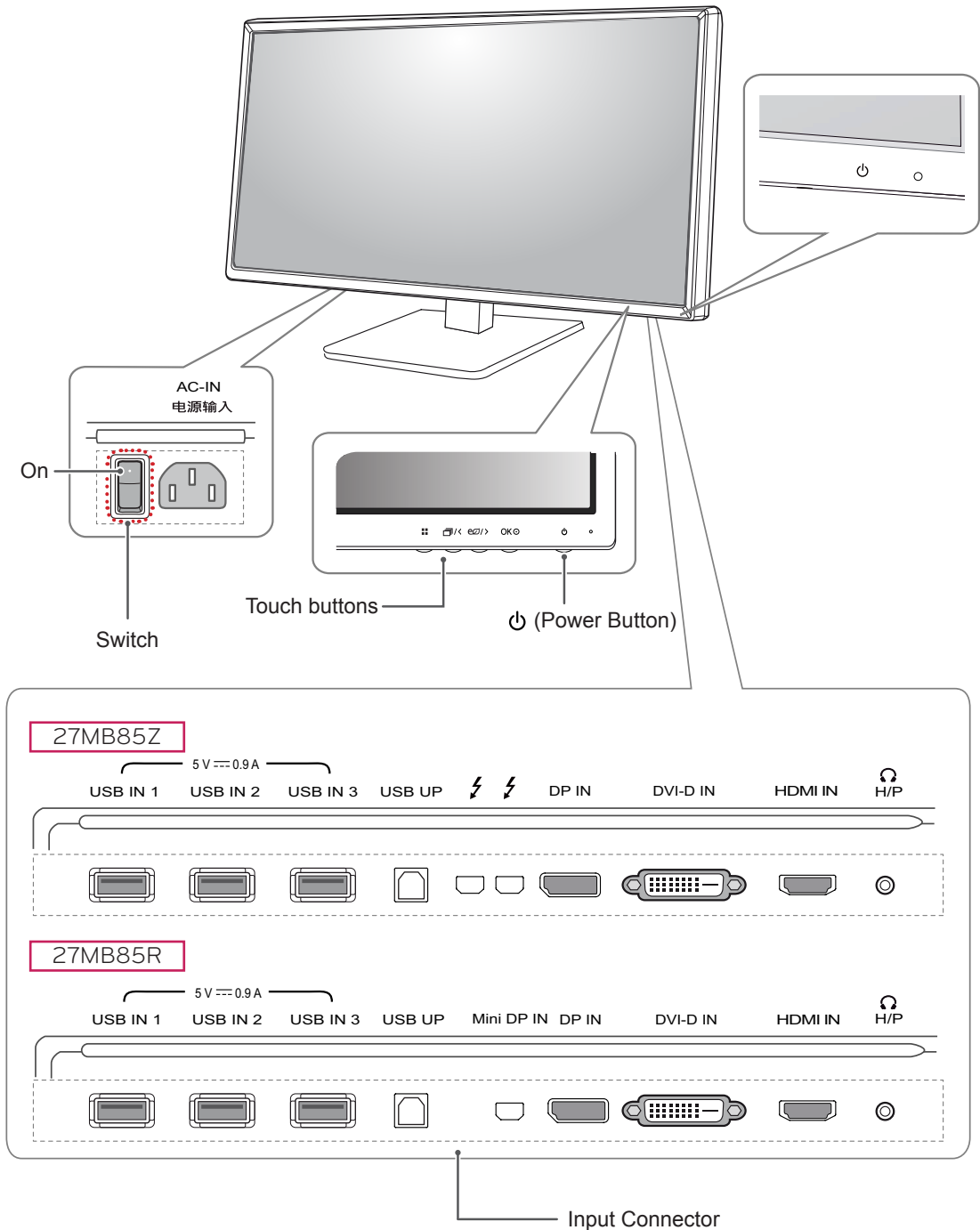

NOTE

- Before turning on the monitor, please make sure that the switch on the rear side of product is On.

Moving and Lifting the Monitor

When moving or lifting the monitor, follow these instructions to prevent the monitor from being scratched or damaged and to ensure safe transportation regardless of its shape or size.



CAUTION

- As much as possible, avoid touching the monitor screen. This may result in damage to the screen or some of the pixels used to create images.
- It is advisable to place the monitor in the original box or packing material before attempting to move it.
- Before moving or lifting the monitor, disconnect the power cord and all cables.
- Hold the top and bottom of the monitor frame firmly. Do not hold the panel itself.

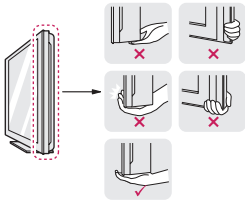

- When holding the monitor, the screen should face away from you to prevent it being scratched.



- When transporting the monitor, do not expose the monitor to jolts or excessive vibration.
- When moving the monitor, keep it upright; never turn the monitor on its side or tilt it sideways.



CAUTION

- Avoid touching the monitor screen as much as possible.
 - This may result in damage to the screen or some of the pixels used to create images.

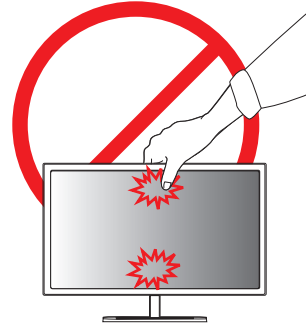

Installing the Monitor

Assembling the Stand Base

- 1 Place the screen face down.
- 2 Rotate the **Stand Body** 90° counter clockwise.

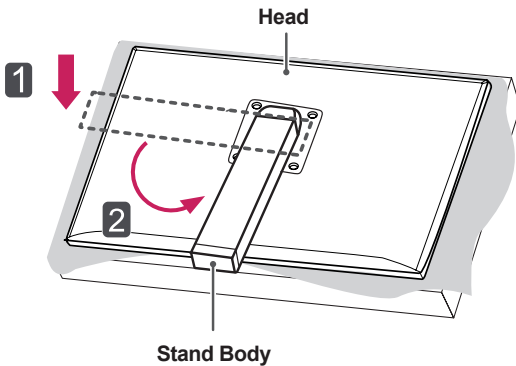

- 3 Align the hole on the **Stand Base** with the **Stand Body** and push it all the way up. Turn the screws on the **Stand Base** to the right.

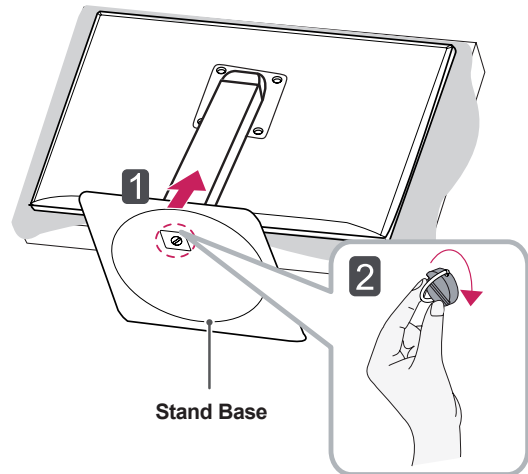

CAUTION

- To protect the screen from scratches, cover the surface with a soft cloth.
- To avoid scratching the head, make sure that when rotating the **Stand Body**, the stand body does not make contact with the head.



CAUTION

- Applying excessive force when tightening screws may cause damage to the monitor. Damage caused in this way will not be covered by the product warranty.

Detaching the Stand Base

- 1 Place the screen face down.



CAUTION

- To protect the screen from scratches, cover the surface with a soft cloth.

- 2 BodyTurn the screws on the **Stand Base** to the left to detach the **Stand Base** from the **Stand Body**.

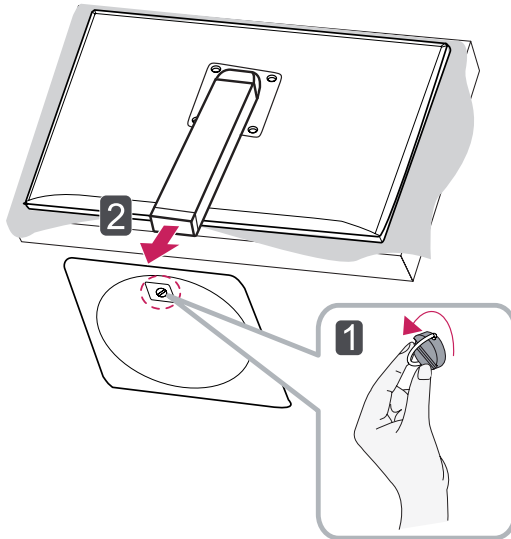

CAUTION

- The components in the illustrations may differ from the actual product.
- Do not carry the monitor upside down, as this may cause it to fall off its stand and result in damage or injury.
- To avoid damaging the screen when lifting or moving the monitor, only hold the stand or the plastic cover. This avoids putting unnecessary pressure on the screen.

Installing on to a Table

- 1 Lift the monitor and place it on the table in an upright position. Place at least **10 cm** away from the wall to ensure sufficient ventilation.

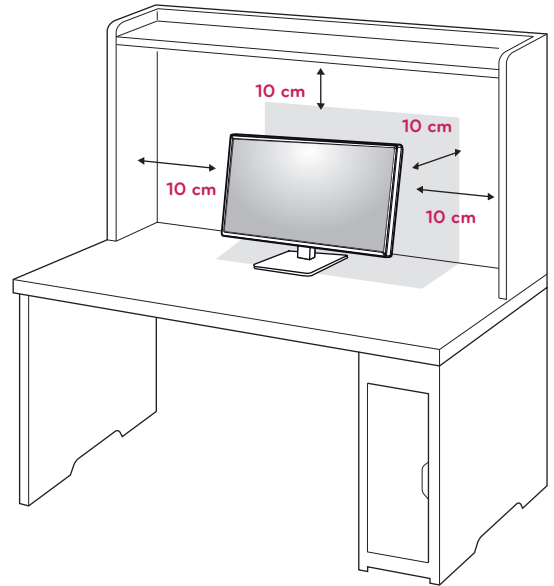

- 2 Connect the **Power Cord** to a wall outlet.

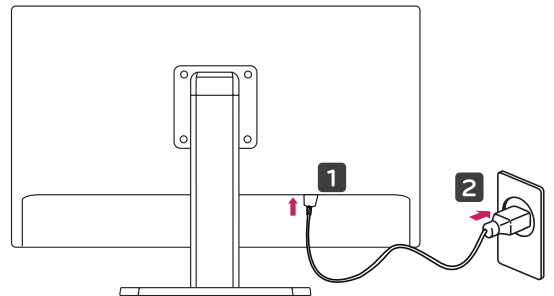

- 3 Press the  (Power) button on the bottom of the monitor to turn it on.



CAUTION

- Disconnect the power cord first, and then move or install the monitor. There is risk of electric shock.

Adjusting the Stand Height

- 1 Place the monitor mounted on the stand base in an upright position.
- 2 Push the **Head** downward and pull out the **Locking Pin**.

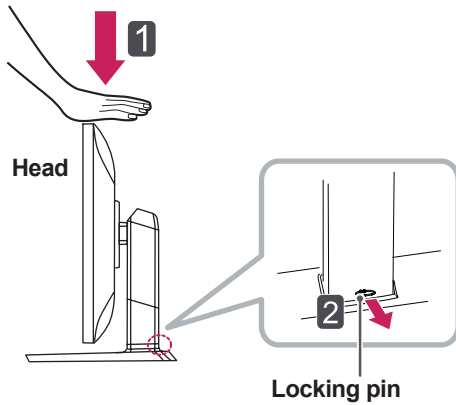

! CAUTION

- Once the pin is removed, it is not necessary to re-insert it to adjust the height.

! WARNING

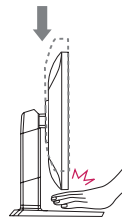

- Do not put your fingers or hand between the screen and the base (chassis) when adjusting the screen's height.

- 3 Handle the monitor with both hands for safety.

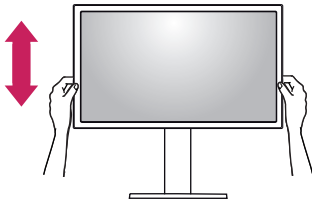

- 4 The height can be adjusted up to **130.0 mm**.

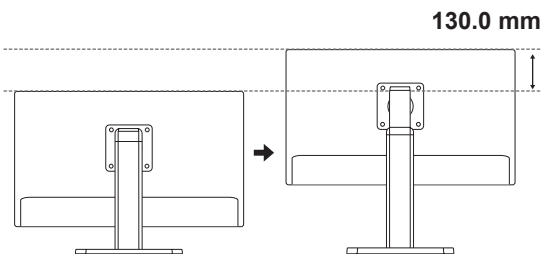

Adjusting the Angle

- 1 Place the monitor in an upright position, mounted on the stand base.
- 2 Adjust the angle of the screen. The angle of the screen can be adjusted forwards or backwards from -5° to 35° for a comfortable viewing experience.

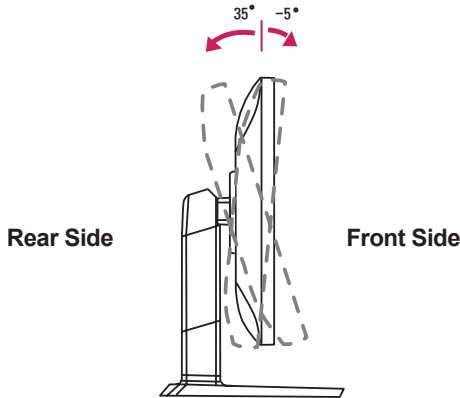

WARNING

- Do not put your fingers or hand between the screen and the base (chassis) when adjusting the screen's height.

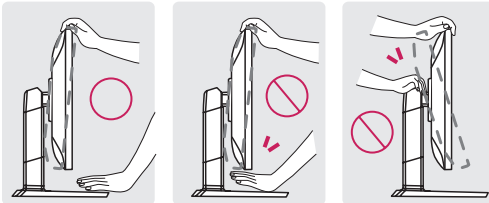

- Be careful not to touch or press the screen area when adjusting the angle of the monitor.

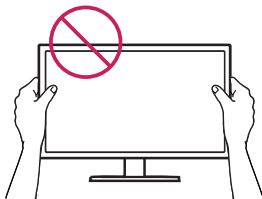

Tidying Cables

- 1 Use the screw provided to attach the cable holder to the stand body as illustrated.

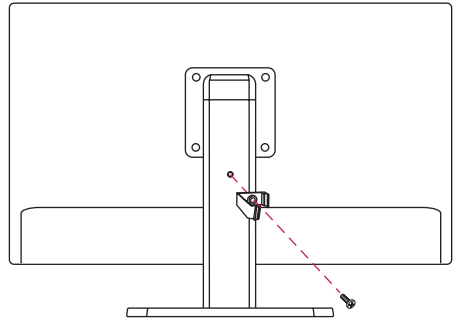

- 2 Gather and bind the cables with the supplied cable holder.

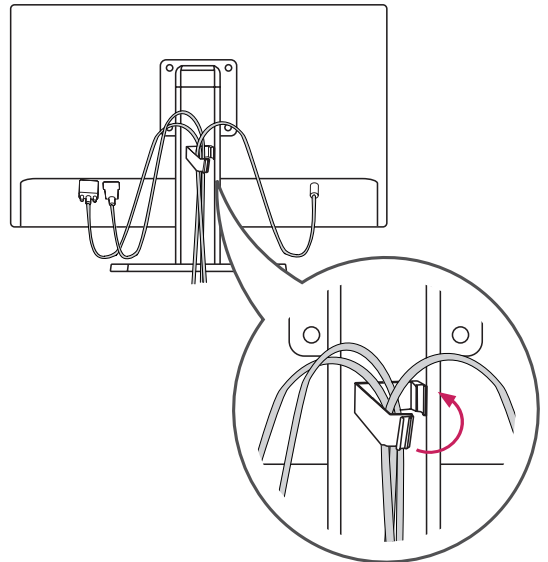

Pivot Feature

The pivot feature allows the monitor to rotate 90° clockwise.

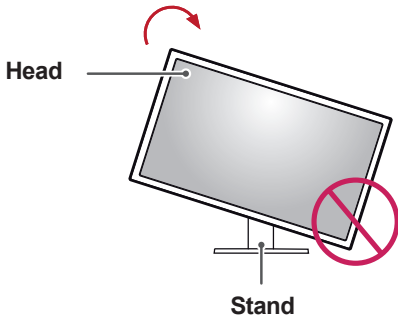

! WARNING

- To avoid scratching the stand base, make sure that when rotating the monitor using the pivot feature, the stand does not make contact with the monitor.

- 1 Raise the monitor to the maximum height.

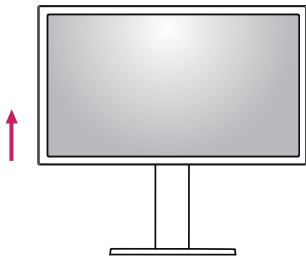

- 2 Adjust the angle of the monitor in the direction of the arrow as shown in the figure.

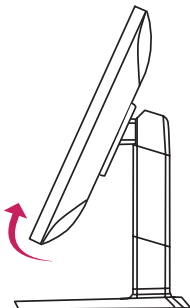

- 3 Rotate the monitor clockwise as shown in the figure.

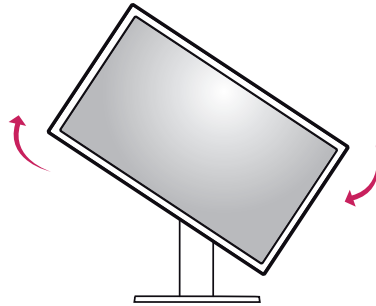

- 4 Complete the installation by rotating the monitor 90° as shown below.



! NOTE

- Auto Pivot feature of the display is not supported.
- The screen can be rotated easily using the screen pivot shortcut key provided with your Windows operating system. Note that some Windows versions may use different settings for the screen pivot key or may not support the pivot key at all.
- Supported Windows versions: Windows 7 and Windows 8
- Windows screen pivot shortcut keys
 - 0°: Ctrl + Alt + Up arrow key (↑)
 - 90°: Ctrl + Alt + Left arrow key (←)
 - 180°: Ctrl + Alt + Down arrow key (↓)
 - 270°: Ctrl + Alt + Right arrow key (→)

! WARNING

- Take care when rotating the monitor if the cable is connected.
- To avoid injury when rotating the display, do not place your fingers between the display and the stand base.

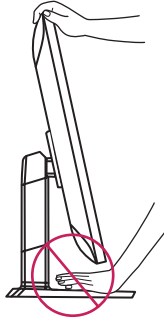
**Using the Kensington Lock**

The Kensington security system connector is located at the back of the Monitor set.

For more information on installation and usage, refer to the Kensington lock user manual or visit the website at <http://www.kensington.com>.

Connect the Kensington security system cable between the Monitor and a table.

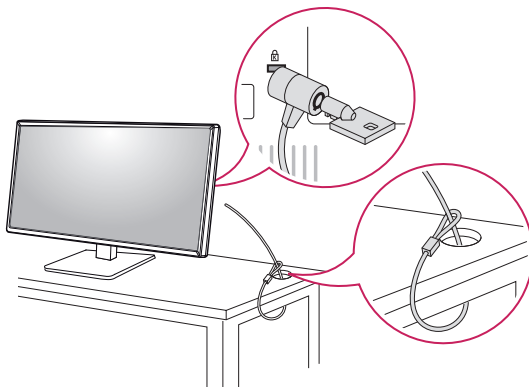
**! NOTE**

- The Kensington security system is optional. You can obtain additional accessories from most electronics stores.

Detaching the Stand Body

- 1 Place the monitor's screen face down. To protect the screen from scratches, cover the surface with a soft cloth.
- 2 Using a screwdriver, remove the four screws and detach the stand from the monitor.

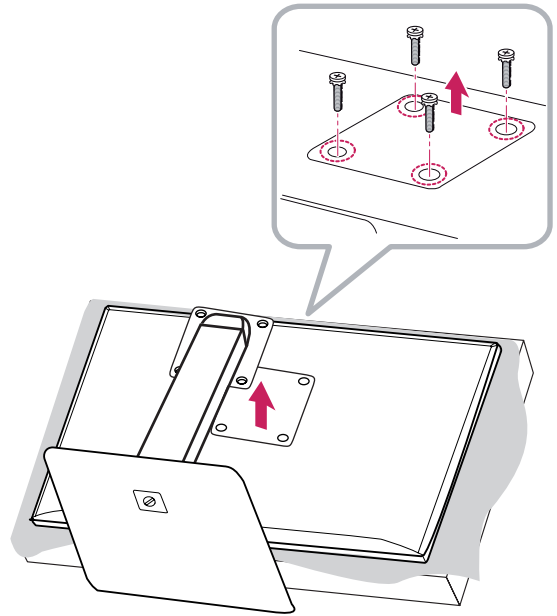

Installing the Wall Mount Plate

This monitor meets the specifications for the wall mount plate or other compatible devices.

- 1 Place the screen face down. To protect the screen from scratches, cover the surface with a soft cloth.
- 2 Place the wall mount plate onto the monitor and align it with the screw holes.
- 3 Tighten the four screws to fix the plate to the monitor using a screwdriver.

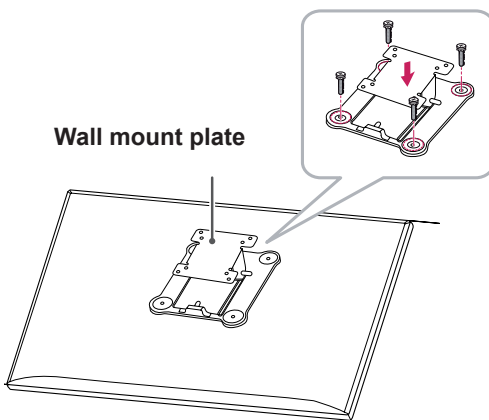

! NOTE

- The wall mount plate is sold separately.
- For more information on installation, refer to the wall mount plate's installation guide.
- Be careful not to apply too much force while mounting the wall mount plate as it may cause damage to the screen.

Installing on the Wall

Install the monitor at least 10 cm away from the wall and leave about 10 cm of space at each side of the monitor to ensure sufficient ventilation.

Detailed installation instructions can be obtained from your local retail store. Alternatively, please refer to the manual for how to install and set up a tilting wall mounting bracket.

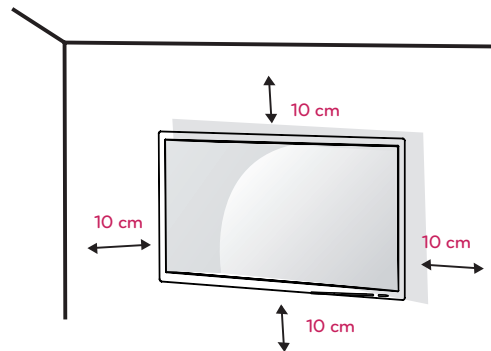

To install the monitor to a wall, attach a wall mounting bracket (optional) to the back of the monitor.

Make sure that the wall mounting bracket is securely fixed to the monitor and to the wall.

- 1 Use the screws and wall mounting bracket that conform to VESA standards.
- 2 If you use screws longer than the standard length, it may damage the inside of the product.
- 3 A non-VESA standard screw may damage the product and cause the monitor to fall. LG Electronics is not liable for any accidents relating to the use of non-standard screws.
- 4 VESA compatible only with respect to screw mounting interface dimensions and mounting screw specifications.
- 5 Use the wall mount plate and fixing screws that conform to VESA standards as specified below.
 - 784.8 mm or less
 - * Thickness of the wall mount plate: 2.6 mm
 - * Fixing screw: Diameter 4.0 mm x Pitch 0.7 mm x Length 10 mm
 - 787.4 mm or more
 - * Use the wall mount plate and screws that conform to VESA standards.

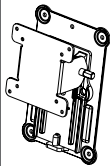
Model	27MB85Z
	27MB85R
VESA (A x B)	100 x 100
Stand Screw	M4 x L10
Required Screws	4
Wall Mount Plate (Optional)	RW120 

- VESA (A x B)

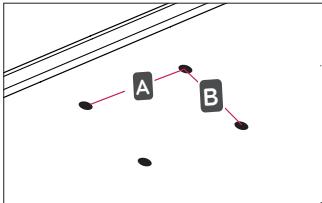

NOTE

- Use the screws specified by VESA standards.
- The wall mount kit includes the installation guide and all necessary parts.
- The wall mounting bracket is optional. You can obtain optional accessories from your local dealer.
- The length of the screw may differ for each wall mounting bracket. Be sure to use the proper length.
- For more information, please refer to the user manual for the wall mounting bracket.

CAUTION

- Unplug the power cord before moving or installing the monitor to avoid electric shock.
- Installing the monitor on the ceiling or on a slanted wall may result in the monitor falling off, which could lead to injury. Use an authorized LG wall mount and contact the local dealer or qualified personnel.
- Applying excessive force when tightening screws may cause damage to the monitor. Damage caused in this way will not be covered by the product warranty.
- Use the wall mounting bracket and screws that conform to VESA standards. Damage caused by the use or misuse of inappropriate components will not be covered by the product warranty.
- To prevent injury, this apparatus must be securely attached to the wall in accordance with the installation instructions. (This only pertains to Australia and New Zealand.)
- When measured from the back of the monitor, the length of each installed screw must be 8 mm or less.

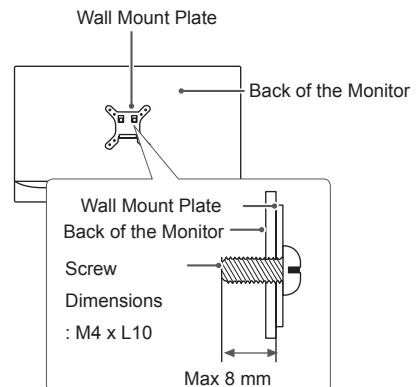

USING THE MONITOR



CAUTION

- Do not press on the screen for a prolonged period of time. This may cause image distortion.
- Do not display a still image on the screen for a prolonged period of time. This may cause image retention. Use a screensaver if possible.



NOTE

- When connecting the power cord to the outlet, use a grounded (3-hole) multi-socket or a grounded power outlet.
- The monitor may flicker when turned on in an area of low temperature. This is normal.
- Sometimes red, green, or blue spots may appear on the screen. This is normal.

Connecting to a PC

- This monitor supports the *Plug and Play feature.
*Plug and Play: A feature that allows you to add a device to your computer without having to reconfigure anything or install any manual drivers.

HDMI Connection

Transmits digital video and audio signals from your PC to the monitor. Connect your PC to the monitor using the HDMI cable as shown in the illustration below.

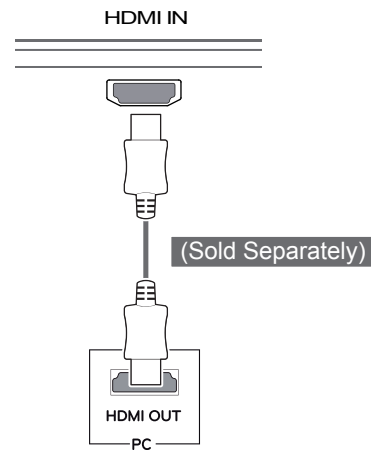

CAUTION

- Connecting your PC to the monitor using the HDMI cable may cause device compatibility issues.
- Using a DVI to HDMI / DP(DisplayPort) to HDMI) cable may cause compatibility issues.

DVI Connection

Transmits digital video signals to the monitor. Connect the monitor using the DVI cable as illustrated below.

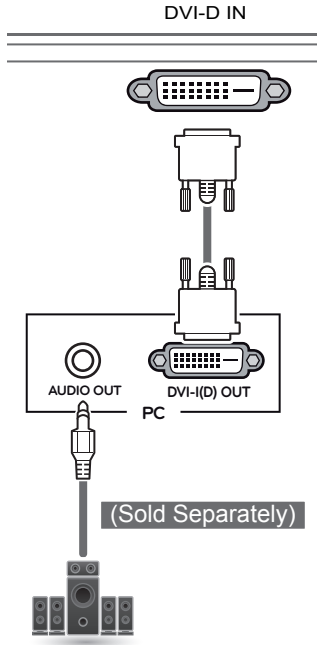

CAUTION

- Connect the input signal cable and turn in the direction of the arrow. To prevent disconnection secure the cable tightly.

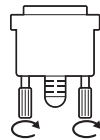

NOTE

- Using a DVI to HDMI cable may cause compatibility issues.
- If you connect a DVI signal cable, use the DVI-D dual cable.

DisplayPort Connection

Transmits digital video and audio signals from your PC to the monitor. Connect the monitor to your PC using the display port cable as shown in the illustration below:

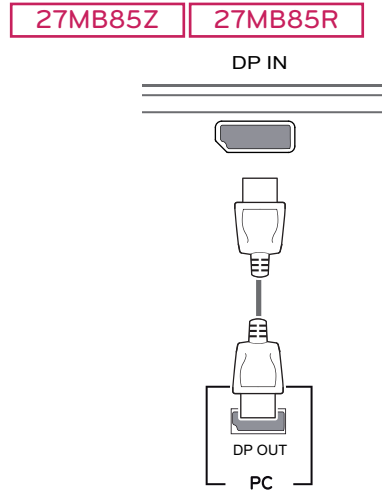

(Sold Separately)

NOTE

- There may be no video or audio output depending on the DP (DisplayPort) version of the PC.
- When using a Mini DP to DP (Mini DisplayPort to DisplayPort) cable, a cable with DisplayPort 1.1a specifications or above is recommended.

Thunderbolt (⚡) Connection

27MB85Z

You can connect your high-resolution display or high-performance data device to the monitor via a Thunderbolt port. Connect your external device to the monitor using the Thunderbolt cable as illustrated below.

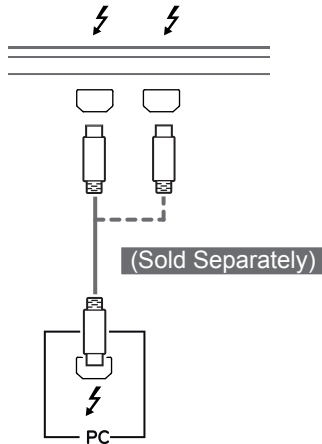

NOTE

- The maximum data transmission rate of each port is 20 Gb/s.
- Make sure to use a Thunderbolt (⚡) certified cable. Otherwise, this may cause the device to malfunction.
- Thunderbolt (⚡) is supported in such environments as Windows 7, Windows 8 and New Mac Pro (Mac OS 10.9).
- To use the Thunderbolt (⚡) port, the ASM driver in the Owner's Manual CD must be installed.
- Dual monitor connection using Thunderbolt (⚡) daisy-chain may not be supported depending on performance of the graphics card.
- Connecting the Thunderbolt (⚡) cables using the daisy-chain method may cause delays in screen display.

Connecting Peripherals

USB Cable Connection - PC

The USB port on the product functions as a USB hub.

NOTE

- Make sure to install the most recent Windows OS service pack before using the product.
- Peripheral devices are sold separately.
- A keyboard, mouse, or USB device can be connected to the USB port.

CAUTION

Cautions When Using a USB Device

- A USB device with an automatic recognition program installed or that uses its own driver may not be recognized.
- Some USB devices may not be supported or may not work properly.
- It is recommended to use a USB hub or hard disk drive with power supplied. (If the power supply is not adequate, the USB device may not be recognized properly.)

HDMI/DP (DisplayPort) Connection

To use USB 3.0, connect the A-B type USB 3.0 cable of the product to the PC. Peripheral devices connected to the USB IN port can be controlled from the PC.

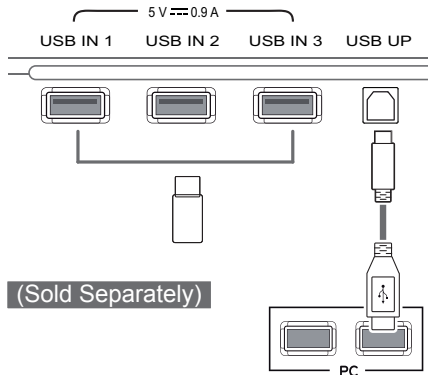

Thunderbolt (⚡) Connection

27MB85Z

Peripheral devices connected to the USB IN port can be controlled from the PC. If you change the input on the menu while a device is in connection via the Thunderbolt port, then the device in connection via the USB port may not work properly.

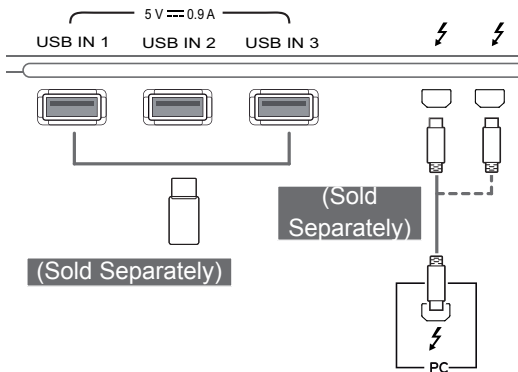

Headphone Port Connection

Use the headphone port to connect a peripheral device to the monitor. Connect as illustrated.

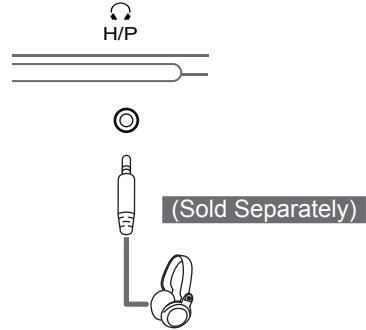

NOTE

- Peripheral devices are sold separately.
- For an angle plug earphone, it is difficult to connect it with a peripheral device, so use a straight type.



Angle Type

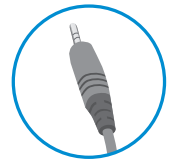

Straight Type

- Depending on the audio settings of the PC and external device, headphone and speaker functions may be limited.

INSTALLING LG MONITOR SOFTWARE

Insert the Software CD included in the product packaging into your PC's CD drive and install the LG Monitor Software.

The installation screen images are for reference only. The actual installation screen images may vary depending on the model.

- 1 Set the default Web browser to Internet Explorer.

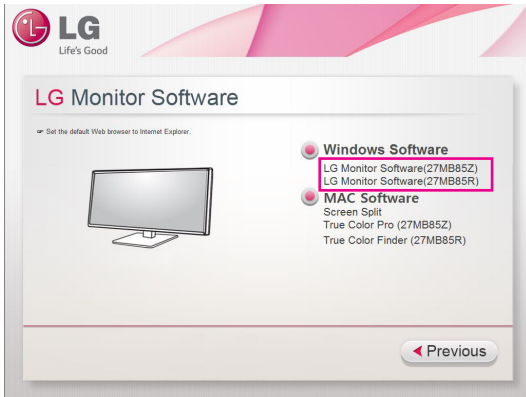

- 2 Click the **LG Monitor Software** on the CD's main screen. When the file download window appears, click the Run button. (The file download window may vary depending on the operating system and the Internet Explorer version, but the installation procedures are same.)



CAUTION

- Service Pack 1 or higher is required for Windows 7.

- 3 Follow the instructions to proceed with the installation.

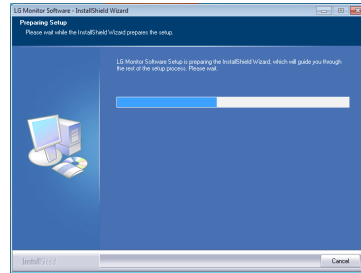

- 4 Check **I accept the terms of the agreement** on the License Agreement screen and then click the **Next** button.

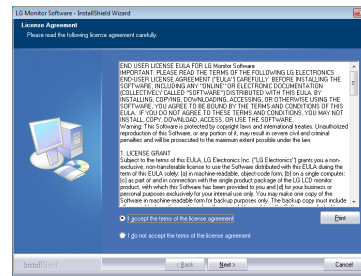

- 5 Select the program that you want to install.

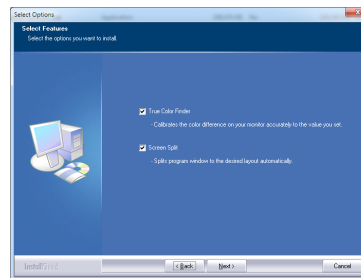

NOTE

- Screen Split: This program automatically splits the program window as desired.
- True Color Finder/ True Color Pro: This program calibrates the precise color output of the monitor to suit your needs.

- 6 The LG Monitor Software installation starts as shown below.

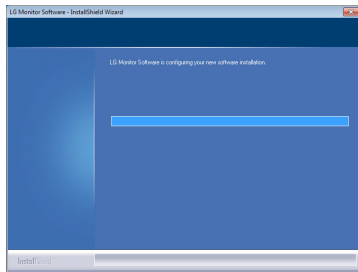

- 7 If the ASM driver has not been installed, the driver will be installed automatically. (Only 27MB85Z model)

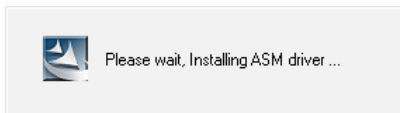

- 8 If the TUSB3410 driver has not been installed, it will install automatically. Select **Install this driver software anyway (I)** if the Windows security message is displayed as below.

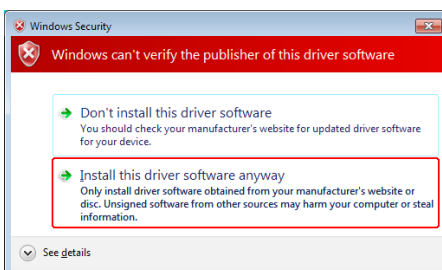

- 9 The program you selected on the Select Features page will install automatically.

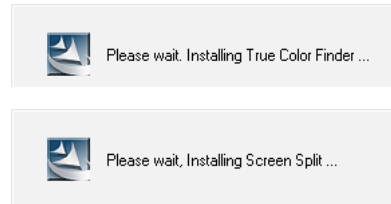

- 10 When the installation is complete, restart your system.

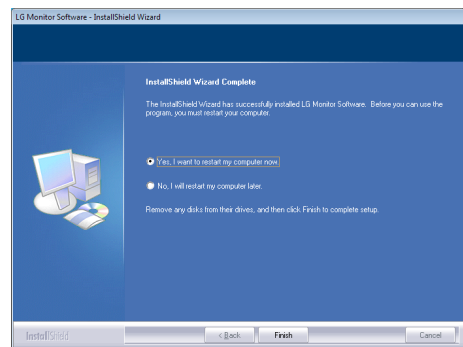

NOTE

When you run the True Color Finder/ True Color Pro software, the True Color Finder/ True Color Pro icon  appears in the system tray at the right bottom of the PC screen.

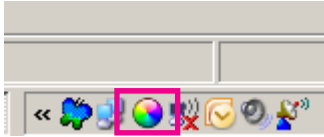

Right-click the True Color Finder icon and select **Start Program** to start the program.

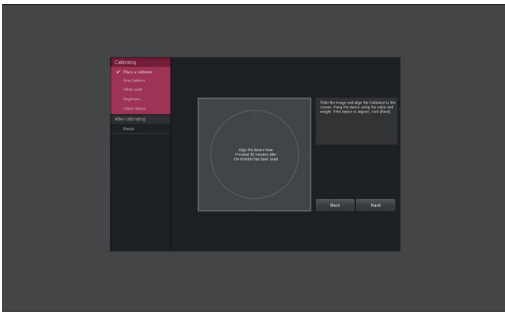

CAUTION

- Once you have completed the monitor calibration with the True Color Finder/ True Color Pro software, remove the calibrator from the monitor and store it at room temperature away from direct sunlight or put it in the box.
 - If the calibrator's measuring part is exposed to direct sunlight for a long time, this may cause damage to the calibrator.
 - Do not store it in an environment with too low/high temperature and high humidity.
- If any third-party calibration application is already installed on your PC, the image quality may be affected by a conflict between the two applications. For the best performance, it is recommended to uninstall the other calibration application.

NOTE

- To use the True Color Finder/ True Color Pro function, you must purchase the supported calibrator.
- For details on supported calibrators and graphic cards, see the True Color Finder/ True Color Pro user guide.
- If you have changed the input port, it is recommend that you calibrate the monitor's picture quality again.

NOTE

If you run Screen Split, the Screen Split icon  appears in the system tray at the right bottom of the PC screen.



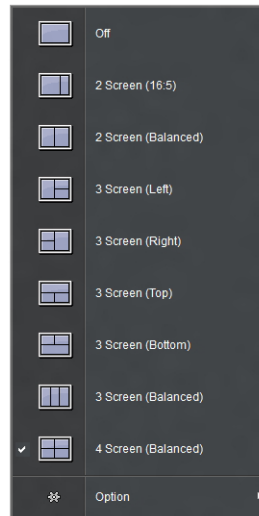

Right-click the Screen Split icon and select a layout you want.





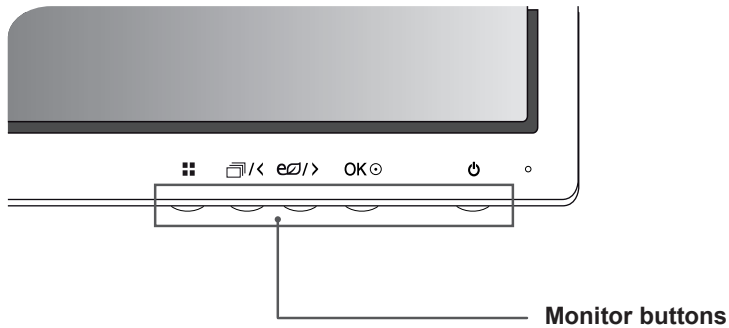

CUSTOMIZING SETTINGS

Activating the Main Menu

- 1 Press the **Menu** () button.
- 2 Use the < > button to adjust the options.
To return to the upper menu or set other menu items, use the **Menu** () button.
- 3 Press and hold the **Menu** () button to exit the OSD menu.





Button	Description	
Menu ()	If the menu is inactive	Activates the main menu.
	If the menu is active	Returns to the previous menu.
 / <	If the menu is inactive	Activates/deactivates a picture mode.
	If the menu is active	Left directional key
 / >	If the menu is inactive	Activates/deactivates the Super Energy Saving (SES) mode.
	If the menu is active	Right directional key
OK 	If the menu is inactive	Confirms the selection.
	If the menu is active	Pressing OK shows the resolution of the current signal (only when there is input signal).
 (Power Button)	Powers on or off.	
	Power Indicator	When the monitor is in operating mode, the power indicator will turn white (on mode). When the monitor is in power-saving mode, the power indicator will blink white.

NOTE

- All of the buttons are touch sensitive and can be operated by simply touching them on the bottom front of the monitor with your finger.

Customizing Settings

Menu Settings

- 1 To view the menu OSD, press the **Menu** () button at the bottom of the monitor.
- 2 Use the < or > button to set the options.
- 3 Select  to exit the OSD menu.
To return to the upper menu or set other menu items, use the **Menu** () button.

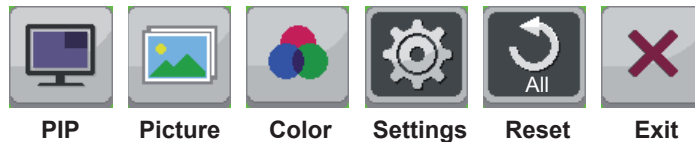
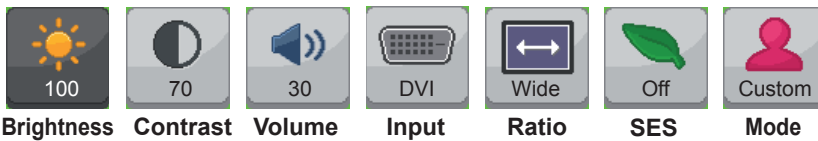



Menu	Description
Brightness	Adjusts the brightness and contrast of the screen.
Contrast	
Volume	Adjusts the volume.
	<div style="border: 1px solid gray; padding: 10px;"> <p> NOTE</p> <ul style="list-style-type: none"> • The volume is disabled in the DVI input mode. • Selecting the OK button in the Volume menu will enable/disable the Mute function. </div>
Input	Selects the current input mode.
Wide/Original	Adjusts the screen ratio.
Super Energy Saving (SES)	Enables or disables the Super Energy Saving function.
Mode	Sets to Custom, sRGB, Adobe RGB (Only 27MB85Z model), DCM Sim., Reader or Calibration.
PIP	Displays the screens of two input modes on one monitor.
Picture	Adjusts the sharpness, black level, and response time of the screen.
Color	Adjusts the gamma, color temperature and color balance of the screen
Settings	Sets the language, main audio, button tone, power indicator, Automatic Standby and OSD lock.
Reset	Resets to the default settings as of the day of purchase.
Exit	Exits the OSD menu.

 **CAUTION**

- Your monitor's OSD (On Screen Display) may differ slightly from that shown in this manual.

Ratio Settings

- 1 To view the menu OSD, press the **Menu** () button at the bottom of the monitor.
- 2 Press < or > to go to **Ratio**.
- 3 Press **OK** to select **Ratio**.
- 4 Use the < or > button to set the options.
- 5 Select  to exit the OSD menu.
To return to the upper menu or set other menu items, use the **Menu** () button.



Sub Menu



Each option is described below.



Menu > Ratio	Description
Wide	Displays the video in wide-screen, regardless of the video signal input.
Original	Displays a video according to the input video signal aspect ratio.
1:1	The aspect ratio is not adjusted from the original.
Back	Moves to the previous OSD screen.
Exit	Exits the OSD menu.

NOTE

- The display may look the same for Wide, Original, and 1:1 options at the recommended resolution (2560 x 1440).
- The ratio is disabled in the interlaced signal.

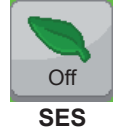
Super Energy Saving (SES) Settings



- 1 To view the menu OSD, press the **Menu** () button at the bottom of the monitor.
- 2 Press < or > to go to **Super Energy Saving (SES)**.
- 3 Press **OK** to select **Super Energy Saving (SES)**.
- 4 Use the < or > button to set the options.
- 5 Select  to exit the OSD menu.
To return to the upper menu or set other menu items, use the **Menu** () button.

Sub Menu

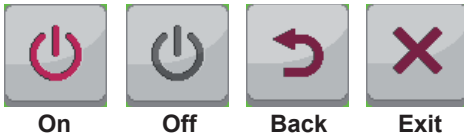

On

Off

Back

Exit



Each option is described below.

Menu > SES	Description	
Super Energy Saving (SES)	On	Enables the Super Energy Saving (SES) function, which allows you to save energy according to the Super Energy Saving (SES) efficiency level.
	Off	Disables the Super Energy Saving (SES) function.

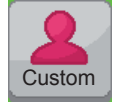
Mode Settings





Mode

- 1 To view the menu OSD, press the **Menu** () button at the bottom of the monitor.
- 2 Press < or > to go to Mode.
- 3 Press OK to select Mode.
- 4 Use the < or > button to set the options.
- 5 Select  to exit the OSD menu.
To return to the upper menu or set other menu items, use the **Menu** () button.

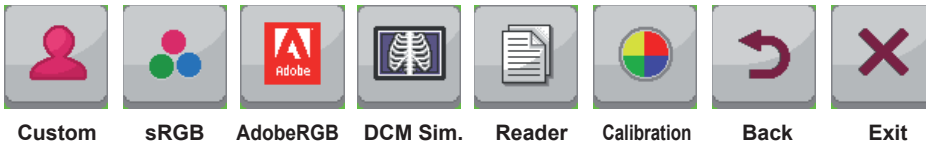

Sub Menu



Each option is described below.

Menu > Mode	Description
Custom	Allows the user to adjust each element. The color mode of the main menu can be adjusted.
sRGB	A standard RGB color space for the monitor and printer.
AdobeRGB (Only 27MB85Z model)	A much larger color space than sRGB. This option is suitable for printing pictures.
DCM Sim.	Optimizes the screen for viewing X-ray images. You can brighten the screen in the OSD menu. <div style="border: 1px solid black; padding: 5px;"> <p> NOTE</p> <ul style="list-style-type: none"> This product has been approved as an IT device and not as a medical device. It is intended for office use only. (It may be used for education and reference purposes but not for medical diagnosis.) </div>
Reader	Optimizes the screen for viewing documents. You can brighten the screen in the OSD menu.
Calibration	Applies the value calibrated by True Color Pro / True Color Finder. <div style="border: 1px solid black; padding: 5px;"> <p> NOTE</p> <ul style="list-style-type: none"> Run the True Color Pro / True Color Finder program. Calibration settings for DVI / HDMI / DP(DisplayPort) & Thunderbolt will be saved separately. (Only 27MB85Z model) Calibration settings for DVI / HDMI / DP(DisplayPort) & miniDP(Mini DisplayPort) will be saved separately. (Only 27MB85R model) </div>
Back	Moves to the previous OSD screen.
Exit	Exits the OSD menu.

PIP settings

- 1 To view the **Menu** OSD, press the **Menu** () button at the bottom of the monitor.
- 2 Press < or > to go to **PIP**.
- 3 Press **OK** to select **PIP**.
- 4 Use the < or > buttons to set the options.
- 5 Select  to exit the OSD menu.
To return to the upper menu or set other menu items, use the **Menu** () button.



Sub Menu



Each option is described below.

Menu > PIP	Description							
PIP	Displays the screens of two input modes on one monitor.							
	<div style="border: 1px solid gray; padding: 5px;"> <p> NOTE</p> <ul style="list-style-type: none"> DP : DisplayPort / TBT : Thunderbolt(¢) / mDP : Mini DisplayPort </div>							
	PIP Connection		Sub screen (Right)					
			DVI-D	HDMI	DP	TBT (27MB85Z)	mDP (27MB85R)	
	Main screen (Left)	DVI-D	-	X	O	O	O	
		HDMI	X	-	O	O	O	
DP		O	O	-	X	X		
TBT (27MB85Z)		O	O	X	-	X		
mDP (27MB85R)		O	O	X	X	-		
Main Audio	Changes the audio output in PIP mode.							
Swap	Toggles between the main screen and sub screen in PIP mode.							
Size	Adjusts the size of the secondary screen.							
	Balanced	Uses a balanced size for the secondary screen.						
	Small	Shows the secondary screen in a small size display.						
	Medium	Shows the secondary screen in a normal size display.						
	Large	Shows the secondary screen in a large size display.						

Menu > PIP	Description	
Position	Adjusts the position of the secondary screen. The default value is Bottom Right.	
	Bottom Right	Shows the secondary screen in the bottom right of the display.
	Bottom Left	Shows the secondary screen in the bottom left of the display.
	Top Left	Shows the secondary screen in the top left of the display.
	Top Right	Shows the secondary screen in the top right of the display.
Ratio	Adjusts the aspect ratio of the sub screen. • Only applicable when Size is set to Balanced.	
	Wide	Displays the video to fit the PIP screen, regardless of the video signal input.
	Original	Displays the video in the input video signal aspect ratio on the PIP screen.
Transparency	Sets the transparency for the sub screen. • Only applicable when Size is set to either Small, Medium or Large.	
	Off	Transparency menu is disabled.
	25%	Sets the transparency to 25%.
	50%	Sets the transparency to 50%.
	75%	Sets the transparency to 75%.
Back	Moves to the previous OSD screen.	
Exit	Exits the OSD menu.	



**NOTE**

- If PIP mode is set to Off, the Main Audio, Swap, Size, Position, Ratio, and Transparency menus are disabled.
If Size is set to Balanced, the Position and Transparency menus are disabled.
The Ratio menu is only enabled in Balanced mode, and is disabled if there is no PIP input signal.

Picture



Picture

- 1 To view the menu OSD, press the **Menu** () button at the bottom of the monitor.
- 2 Press < or > to go to **Picture**.
- 3 Press **OK** to select **Picture**.
- 4 Use the < or > button to set the options.
- 5 Select  to exit the OSD menu.
To return to the upper menu or set other menu items, use the **Menu** () button.

Sub Menu

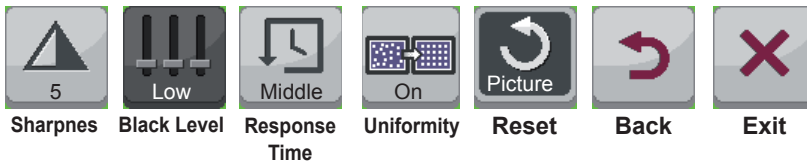

Sharpnes Black Level Response Time Uniformity Reset Back Exit

Each option is described below.

Menu > Picture	Description
Sharpness	Adjusts the sharpness of the screen.
Black Level	Sets the offset level (for HDMI only). • Offset: as a reference for a video signal, this is the darkest color the monitor can display.
	High The picture of the screen gets brighter.
	Low The picture of the screen gets darker.
Response Time	Sets a response time for displayed pictures based on the speed of the screen. For a middle environment, it is recommended that you use Middle. For a fast-moving picture, it is recommended that you use High. Setting to High may cause image sticking.
	High Sets the response time to High.
	Middle Sets the response time to Middle.
	Low Sets the response time to Low.
Uniformity	Adjusts uniformity of the image. <div style="border: 1px solid black; padding: 10px; margin-top: 10px;"> <p> NOTE</p> <ul style="list-style-type: none"> • The Uniformity menu is activated only in sRGB and Adobe RGB (supported by 27MB85Z only) modes. Enabling Uniformity may reduce the overall brightness of the image. </div>
Reset	Resets the picture function to the default settings.
Back	Moves to the previous OSD screen.
Exit	Exits the OSD menu.

Color



Color

- 1 To view the menu OSD, press the **Menu** () button at the bottom of the monitor.
- 2 Press < or > to go to **Color**.
- 3 Press **OK** to select **Color**.
- 4 Use the < or > button to set the options.
- 5 Select to exit the OSD menu.
To return to the upper menu or set other menu items, use the **Menu** () button.

Sub Menu





Each option is described below.

Menu > Color	Description	
Gamma	Custom gamma setting: When using the gamma 2.0, gamma 2.2, and gamma 2.4 monitor settings, higher gamma settings mean a brighter image is displayed and vice versa.	
Color Temp	Adjusts the color temperature in 500K increments. (Note that 9300K is supported instead of 9500K.)	
Red	You can customize the picture color using Red, Green, and Blue colors.	
Green		
Blue		
Six Color	Meets the user requirements for colors through adjusting the color and saturation of the six colors (red, green, blue, cyan, magenta, yellow) and saving the settings.	
	Hue	Adjusts tone of the screen.
	Saturation	Adjusts the saturation of the screen colors. The lower the value, less saturated and bright the colors become. The higher the value, the more saturated and dark the colors become.
Reset	Returns the color settings to the default settings.	
Back	Moves to the previous OSD screen.	
Exit	Exits the OSD menu.	

Settings



Settings

- 1 To view the menu OSD, press the **Menu** () button at the bottom of the monitor.
- 2 Press < or > to go to **Settings**.
- 3 Press **OK** to select **Settings**.
- 4 Use the < or > button to set the options.
- 5 Select  to exit the OSD menu.
To return to the upper menu or set other menu items, use the **Menu** () button.

Sub Menu

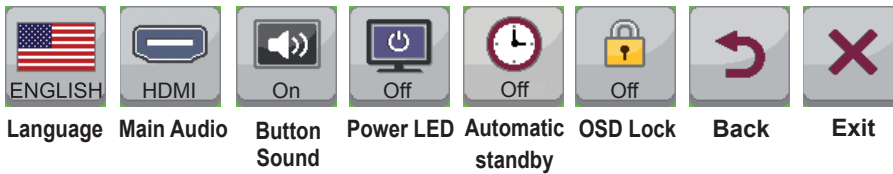

Each option is described below.

Menu > Settings	Description				
Language	Sets the menu screen to the desired language.				
Main Audio	Outputs the sound through the monitor's headset connected the digital input (except for DVI). <div style="border: 1px solid gray; padding: 5px;"> <p>NOTE</p> <ul style="list-style-type: none"> This option is available only when the PIP option is set to HDMI + DP, HDMI + TBT (Mini DP), DP + HDMI, or TBT (Mini DP) + HDMI. </div>				
Button Sound	Controls the button tone. The button tone is heard for the following actions. <ul style="list-style-type: none"> DC Power On/Off Menu OSD On/Off 				
Power LED	Turns the power indicator on the front side of the monitor on/off. <table border="1" style="width: 100%; margin-top: 5px;"> <tr> <td style="width: 10%;">On</td> <td>The power indicator is turned on.</td> </tr> <tr> <td>Off</td> <td>The power indicator is turned off.</td> </tr> </table>	On	The power indicator is turned on.	Off	The power indicator is turned off.
On	The power indicator is turned on.				
Off	The power indicator is turned off.				
Automatic Standby	Feature that automatically turns off the monitor when there is no movement on the screen for a period of time. You can set a timer for the auto-off function. (Off, 4 H, 6 H, and 8 H)				
OSD Lock	Prevents incorrect key input. <table border="1" style="width: 100%; margin-top: 5px;"> <tr> <td style="width: 10%;">On</td> <td>Key input is disabled.</td> </tr> <tr> <td>Off</td> <td>Key input is enabled.</td> </tr> </table> <div style="border: 1px solid gray; padding: 5px;"> <p>NOTE</p> <ul style="list-style-type: none"> All functions except for the OSD Lock mode and the Exit button for Brightness, Contrast, Volume, Input, and Settings are disabled. </div>	On	Key input is disabled.	Off	Key input is enabled.
On	Key input is disabled.				
Off	Key input is enabled.				
Back	Moves to the previous OSD screen.				
Exit	Exits the OSD menu.				

TROUBLESHOOTING

Nothing is displayed on the screen.	
Is the monitor's power cord plugged in?	<ul style="list-style-type: none"> • Check if the power cord is correctly plugged in to the power outlet.
Is the power LED on?	<ul style="list-style-type: none"> • Check the power indicator.
Is the power on and the power LED displaying white?	<ul style="list-style-type: none"> • Check that the connected input is enabled (Menu - Input).
Is the power LED blinking?	<ul style="list-style-type: none"> • If the monitor is in power-saving mode, move the mouse or press any key on the keyboard to switch the display on. • Check if the computer is turned on.
Is the OUT OF RANGE message displayed?	<ul style="list-style-type: none"> • This occurs when signals transferred from the PC (video card) are out of the horizontal or vertical frequency range of the monitor. Please see the Product Specification section of this manual to set the appropriate frequency.
Is the CHECK SIGNAL CONNECTION message is displayed?	<ul style="list-style-type: none"> • This is displayed when the signal cable between the PC and the monitor is missing or disconnected. Check the cable and reconnect.

The OSD LOCKED message is displayed.	
Are some functions unavailable when pressing the Menu button?	<ul style="list-style-type: none"> • The OSD is locked. Go to Menu > Settings and set OSD Lock to Un-lock.

The screen retains an image.	
Does image sticking occur even when the monitor is turned off?	<ul style="list-style-type: none"> • Displaying a still image for a prolonged time may cause damage to the screen, resulting in the retention of the image. • Use a screen saver to protect the screen when using the monitor for a prolonged period of time.

NOTE

- **Vertical Frequency:** In order to display an image, the screen must be refreshed dozens of times per second like a fluorescent lamp. The number of times the screen is refreshed per second is called vertical frequency or refresh rate and is represented by Hz.
- **Horizontal Frequency:** The time it takes to display one horizontal line is called the horizontal cycle. The number of horizontal lines displayed in one second can be calculated by dividing one by the horizontal cycle. This is called horizontal frequency and is represented by kHz.

NOTE

- Check if the video card's resolution or frequency is within the range allowed by the monitor and set to the recommended (optimal) resolution in **Control Panel > Display > Settings**.
- Failing to set the video card to the recommended (optimal) resolution may result in blurred text, a dimmed screen, a truncated display area or misalignment of the display.
- The configuration procedure may differ depending on your computer and/or operating system. Also, some video cards may not support certain resolutions. If this is the case, contact the manufacturer of the computer or video card for assistance.
- Some video cards may not support 2560 x 1440 resolution. If the resolution cannot be displayed, contact the manufacturer of your video card.

The display color is abnormal.

Does the display appear discolored (16 color)?	<ul style="list-style-type: none"> • Set the color to 24 bit (true color) or higher. In Windows, go to Control Panel > Display > Settings > Color Quality.
Does the display color appear unstable or in monochrome?	<ul style="list-style-type: none"> • Check if the signal cable is connected properly. Reconnect the cable or reinsert the PC's video card.
Are there spots on the screen?	<ul style="list-style-type: none"> • When using the monitor, pixilated spots (red, green, blue, white or black) may appear on the screen. This is normal for the LCD screen. It is not an error nor is it related to the monitor's performance.

SPECIFICATIONS

27MB85Z

LCD Screen	Type	68 cm TFT (Thin Film Transistor) LCD (Liquid Crystal Display) Screen Diagonal length of the screen: 68 cm		
	Pixel Pitch	0.2331 mm x 0.2331 mm		
	Color Depth	Thunderbolt(⚡)	8-bit color is supported.	
		DVI-D		
DP(DisplayPort)		10-bit color is supported.		
	HDMI			
Resolution	Maximum Resolution	2560 x 1440 @ 60 Hz		
	Recommended Resolution	2560 x 1440 @ 60 Hz		
Video Signal (Video Signal)	Horizontal Frequency	30 kHz to 90 kHz		
	Vertical Frequency	57 Hz to 75 Hz		
	Synchronization	Separate Sync.		
Input Connector	USB IN 1, 2, 3, USB UP, Thunderbolt(⚡), DP(DisplayPort) IN, DVI-D IN, HDMI IN, H/P OUT			
Power	Voltage	AC 100-240 V~ 50 / 60 Hz 1.4 A		
	Power consumption (Typ.)	On Mode: 80 W Power Saving Mode ≤ 1.2 W		
		Off Mode	Power Button	≤ 0.5 W
		Switch	0 W	
Stand Angle	Forward/Backward: -5° to 35° (Head)			
Environmental Conditions	Operating Condition	Temperature: 10°C to 35°C; Humidity: 20% to 80%		
	Storing Condition	Temperature: -10°C to 60°C; Humidity: 5% to 90%		
Dimension	Monitor Size (Width x Height x Depth)			
	With stand	643 mm x 417 mm x 258.6 mm		
	Without Stand	643 mm x 417 mm x 55.6 mm		
Weight (Without Packaging)	7.6 kg			

The specifications are subject to change without notice.

27MB85R

LCD Screen	Type	68 cm TFT (Thin Film Transistor) LCD (Liquid Crystal Display) Screen Diagonal length of the screen: 68 cm		
	Pixel Pitch	0.2331 mm x 0.2331 mm		
	Color Depth	8-bit color is supported.		
Resolution	Maximum Resolution	2560 x 1440 @ 60 Hz		
	Recommended Resolution	2560 x 1440 @ 60 Hz		
Video Signal (Video Signal)	Horizontal Frequency	30 kHz to 90 kHz		
	Vertical Frequency	57 Hz to 75 Hz		
	Synchronization	Separate Sync.		
Input Connector	USB IN 1, 2, 3, USB UP, Mini DP(Mini DisplayPort) IN, DP(DisplayPort) IN, DVI-D IN, HDMI IN, H/P OUT			
Power	Voltage	AC 100-240 V~ 50 / 60 Hz 1.3 A		
	Power consumption (Typ.)	On Mode: 60 W Power Saving Mode ≤ 1.2 W		
		Off Mode	Power Button Switch	≤ 0.5 W 0 W
Stand Angle	Forward/Backward: -5° to 35° (Head)			
Environmental Conditions	Operating Condition	Temperature: 10°C to 35°C; Humidity: 20% to 80%		
	Storing Condition	Temperature: -10°C to 60°C; Humidity: 5% to 90%		
Dimension	Monitor Size (Width x Height x Depth)			
	With stand	643 mm x 417 mm x 258.6 mm		
	Without Stand	643 mm x 417 mm x 55.6 mm		
Weight (Without Packaging)	6.7 kg			

The specifications are subject to change without notice.

Factory Support Mode (Preset Mode PC)

Preset Mode, PC	Horizontal Frequency (kHz)	Vertical Frequency (Hz)	Polarity (H/V)	Remarks
720 x 400	31.468	70.08	-/+	
640 x 480	31.469	59.94	-/-	
640 x 480	37.5	75	-/-	
800 x 600	37.879	60.317	+/+	
800 x 600	46.875	75	+/+	
1024 x 768	48.363	60	-/-	
1024 x 768	60.123	75.029	+/+	
1152 x 864	67.5	75	+/+	
1280 x 1024	63.981	60.02	+/+	
1280 x 1024	79.976	75.025	+/+	
1680 x 1050	65.29	59.954	-/+	
1600 x 1200	75	60	+/+	
1920 x 1080	67.5	60	+/-	
1920 x 1200	74.038	59.950	+/-	
2560 x 1440	88.79	59.95	+/-	Recommended Mode

* D-SUB/DVI DTV modes (interlace mode) are not supported.

HDMI Timing (Video)

Preset Mode, PC	Horizontal Frequency (kHz)	Vertical Frequency (Hz)	Remarks
480P	31.50	60	
576P	31.25	50	
720P	37.50	50	
720P	45.00	60	
1080i	28.12	50	
1080i	33.75	60	
1080P	56.25	50	
1080P	67.50	60	

Power LED

Mode	LED Color
On Mode	Illuminates white
Power-saving	Blinking in white
Off Mode	Off

PROPER POSTURE

Adjust the screen so that you can comfortably look at it at a slight downward angle from your natural eye level.

- Take a break for approximately 10 minutes every hour to reduce any fatigue caused by long-time usage.
- The stand of the touch monitor allows the product to be used in the optimum position. Adjust the stand angle from -5° to 35° to obtain the best view of the screen.

You should be looking slightly down at the screen.

Adjust the angle -5° to 35°

So that there is no reflection or glare from the screen.

Place your hands gently on the keyboard, keeping your arms bent at the elbows and extended horizontally in front of you.

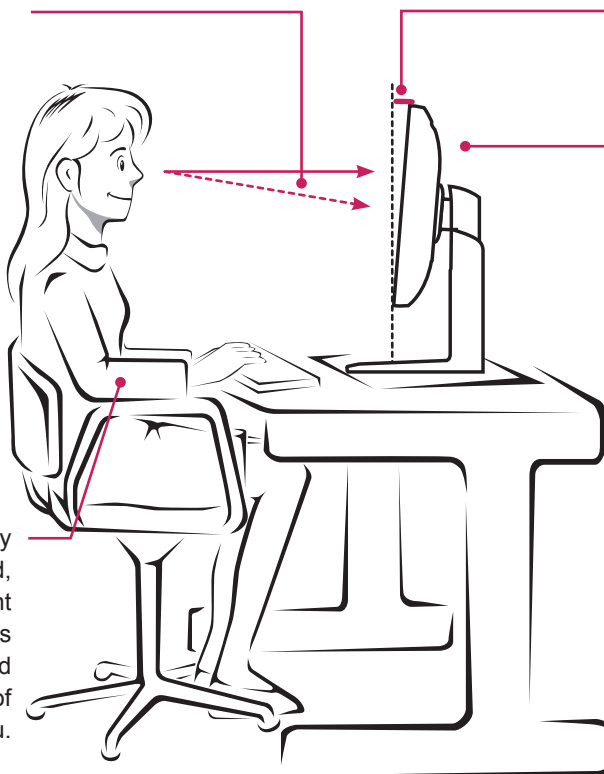



This device meets the EMC requirements for home appliances (Class B) and is intended for home usage. This device can be used in all regions. Read the owner's manual (CD) carefully and keep it at hand. Please note that the label attached to the product provides information for technical support.

Model _____
Serial No. _____

ENERGY STAR is a set of power-saving guidelines issued by the U.S. Environmental Protection Agency (EPA).



As an ENERGY STAR Partner LGE U. S. A., Inc. has determined that this product meets the ENERGY STAR guidelines for energy efficiency.

Refer to ENERGY STAR.gov for more information on the ENERGY STAR program.