



OWNER'S MANUAL

MEDICAL MONITOR

Please read this manual carefully before operating your set and retain it for future reference.

32HL512D

www.lg.com

Copyright © 2019 LG Electronics Inc. All Rights Reserved.

CONTENTS

ON CLEANING	3
LICENSE	4
OPEN SOURCE SOFTWARE NOTICE INFORMATION	4
ASSEMBLY AND PREPARING	5
USING THE MONITOR.....	19
USER SETTINGS	21
TROUBLESHOOTING	34
PRODUCT SPECIFICATIONS	37

Please note that this information is for proper use and safety of the equipment. The following symbols may indicate a hazardous situation in which, if not heeded, may result in serious injury or even death to the user or others, or damage to the equipment.

WARNING

- Indicates warning and safety instructions. If not adhered to, it could result in death or serious injury to the user or others.

CAUTION

- Indicates a hazardous situation which, if not heeded, may result in minor or moderate injury to the user or others, or damage to the equipment.

ON CLEANING

Recommended Cleaning Chemicals

- Isopropanol 70 %
- Ethanol 70 %
- 0.9 % NaCl solution

How to Use Cleaner

- Prior to cleaning, turn off the monitor and remove the power cable.
- Soak a soft cloth in a recommended cleaner, then lightly rub the screen with no more than 1 N of force.
- The cleaner could cause serious damage if it leaks inside the monitor while cleaning.
- The display could be damaged, so only clean the parts of the monitor other than the screen's LCD panel.
- Do not use benzene, thinner, acids or alkaline cleaners or other such solvents.
- Cleaning guidelines for displays must only be carried out by medical professionals (Doctors or Nurses) and must not be handled by patients.

LICENSE

Each model has different licenses. Visit www.lg.com for more information on the license.



The terms HDMI, HDMI High-Definition Multimedia Interface, and the HDMI Logo are trademarks or registered trademarks of HDMI Licensing Administrator, Inc.

OPEN SOURCE SOFTWARE NOTICE INFORMATION

To obtain the source code under GPL, LGPL, MPL, and other open source licenses, that is contained in this product, please visit <http://opensource.lge.com>. In addition to the source code, all referred license terms, warranty disclaimers and copyright notices are available for download. LG Electronics will also provide open source code to you on CD-ROM for a charge covering the cost of performing such distribution (such as the cost of media, shipping, and handling) upon email request to opensource@lge.com. This offer is valid for a period of three years after our last shipment of this product. This offer is valid to anyone in receipt of this information.

ASSEMBLY AND PREPARING

Product Composition

Please check whether all the components are included in the box before using the product. If there are any missing components, contact the retailer where you purchased the product. Note that the product and related components may look different from those shown here.



CD (Owner's Manual / Software)/Regulatory Manual/Cards

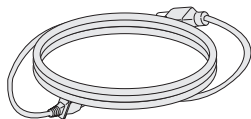

Power Cord

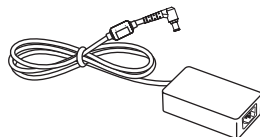

AC/DC Adaptor



Cable Holder

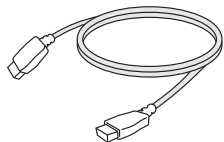

HDMI Cable

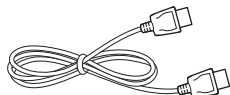

DisplayPort Cable

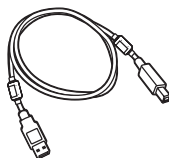

USB 2.0 Cable

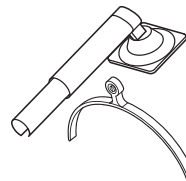

Stand Body / Stand Base

⚠ CAUTION

- Always use genuine LG components to ensure safety and product performance.
- The product warranty will not cover damage or injury caused by the use of unauthorized components.
- It is recommend that use the supplied components.
- If you use generic cables not certified by LG, the screen may not display or there may be image noises.
- Only use components listed below that meet the listed standard. Unauthorized components may cause damage to and malfunction of the product.

Component	Standard
HDMI Cable	UL, Impedance 100 ohm
DisplayPort Cable	UL, Impedance 100 ohm
USB 2.0 Cable	UL
Power Cord	US – Approved Medical grade regulation Others – Approved country safety regulation

- The AC/DC adaptors and etc. except the upper components need to be used only supplied by manufacturer.

! NOTE

- The components may look different from those illustrated here.
- Without prior notice, all product information and specifications contained in this manual are subject to change to improve the performance of the product.
- To purchase optional accessories, visit an electronics store or an online shopping site, or contact the retailer from which you purchased the product.
- The power cord provided may differ depending upon the region.

Supported Software

Check the drivers and software supported by your product and refer to the manuals on the CD enclosed in the product package.

Drivers and Software	Installation Priority
PerfectLum	Recommended
On Screen Control	Optional
Dual Controller	Optional



- The [PerfectLum Serial Number] can be found in [General] > [Information].
- PerfectLum calibrates the color output of the monitor using Hardware Calibration. The program supports USB communication, so connect your PC and monitor using a USB cable and launch the PerfectLum program.
- Required and Recommended: You can download and install the latest version from the enclosed CD or from the LGE website (www.lg.com).
- Optional: You can download and install the latest version from the LGE website (www.lg.com).

Product and Button Description



How to Use the Joystick Button

You can easily control the functions of the monitor by pressing the joystick button or moving it left/right/up/down with your finger.

		Power on	Press the joystick button once with your finger to turn on the monitor.
		Power off	Press and hold the joystick button once more than 5 seconds with your finger to turn off the monitor.

! NOTE

- The joystick button is located at the bottom of the monitor.

Connectors

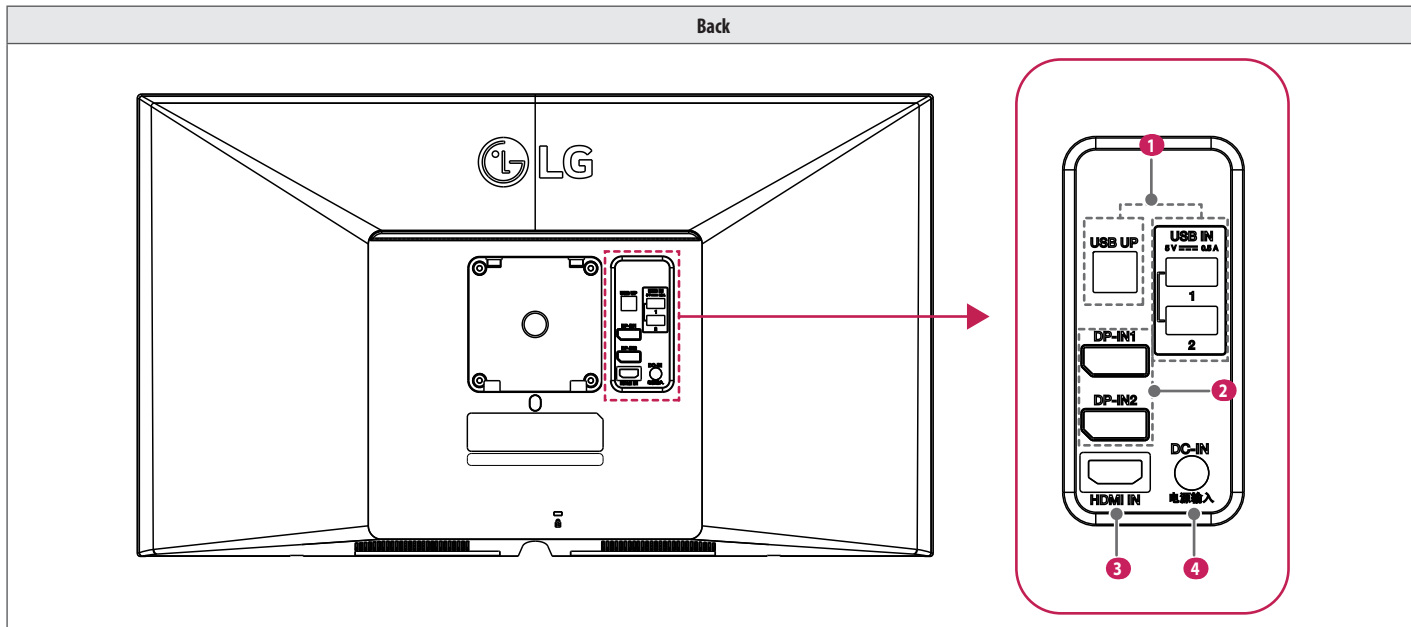

<p>1</p>	<p>USB IN 5 V --- 0.5 A / USB UP</p> <ul style="list-style-type: none"> • Used for HW Calibrator (Optional Accessory) connection. • Connect peripheral device to the USB input port. • A keyboard, mouse, or USB storage device can be connected. • To use USB 2.0, connect the A-B type USB 2.0 cable to the PC. <p> CAUTION</p> <p>Cautions When Using a USB Storage Device</p> <ul style="list-style-type: none"> • A USB storage device which has a built-in automatic recognition program or uses its own driver might not be recognizable. • Some USB storage devices may not be supported or may not work properly. • It is recommended to use a USB hub or hard disk drive with power supplied. (If the power supplied is not enough, the USB device may not be detected properly.)
<p>2</p>	<p>DP-IN1 / DP-IN2</p> <ul style="list-style-type: none"> • Receives or transmits digital video signals. • There may be no video output depending on the DisplayPort version of your PC. • A cable with DisplayPort 1.2 specifications is recommended when using a Mini DisplayPort to DisplayPort cable.
<p>3</p>	<p>HDMI IN</p> <ul style="list-style-type: none"> • Input digital video signal. • Using a DVI to HDMI / DisplayPort to HDMI cable may cause compatibility issues. • Use a certified cable that displays the HDMI logo. The screen may not appear or a connection error could occur if a non-certified cable is used. • Recommended HDMI cable types <ul style="list-style-type: none"> - High-speed HDMI[®]/TM cable - High-speed HDMI[®]/TM Ethernet cable
<p>4</p>	<p>DC-IN</p> <ul style="list-style-type: none"> • Connect an AC/DC adapter. • The output of the enclosed adaptor is 19 V.

! NOTE

- This monitor supports the *Plug and Play feature.
- * Plug and Play: A feature that allows you to add a device to your computer without the need for physical device configuration or user intervention.

Assembling the Stand base

1

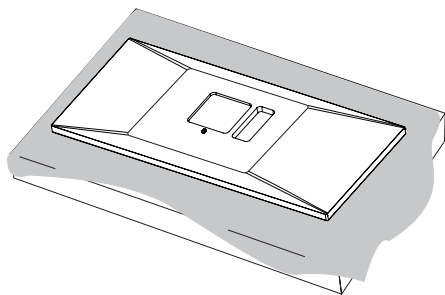

⚠ CAUTION

- To protect the screen from scratches, cover the surface with a soft cloth.

2

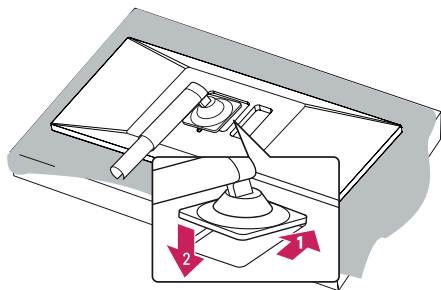

3

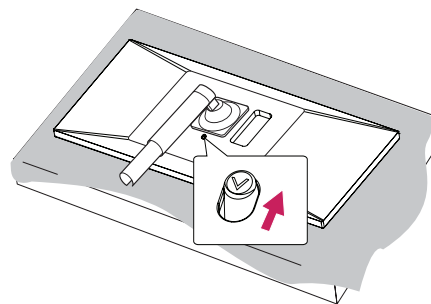

4

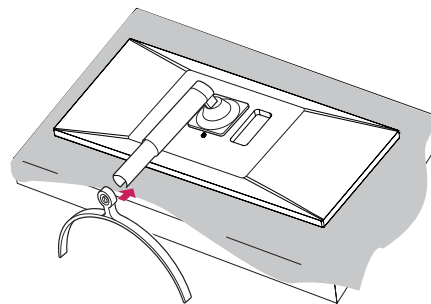

5

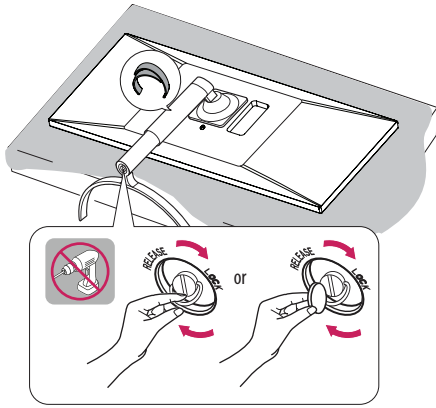

6

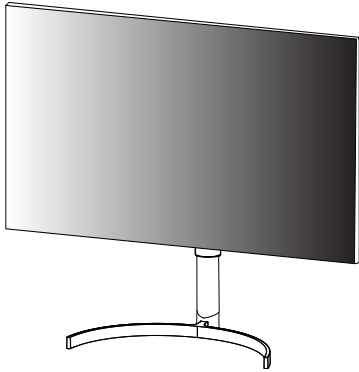

7

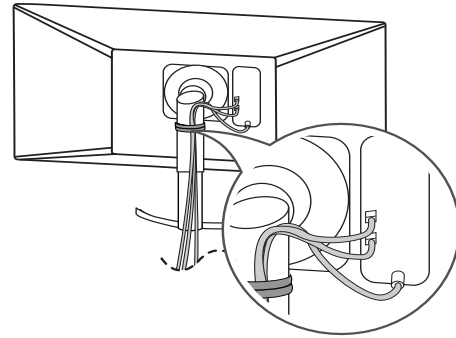

⚠ CAUTION

- Illustrations in this document represent typical procedures, so they may look different from the actual product.
- Do not apply foreign substances (oils, lubricants, etc.) to the screw parts when assembling the product. (Doing so may damage the product.)
- Applying excessive force when tightening screws may cause damage to the monitor. Damage caused in this way will not be covered by the product warranty.
- Do not carry the monitor upside down by just holding the base. This may cause the monitor to fall off the stand and could result in personal injury.
- When lifting or moving the monitor, do not touch the monitor screen. The force applied to the monitor screen may cause damage to it.

! NOTE

- You can disassemble the stand in the reverse order of the assembly.

Moving and Lifting the Monitor

When moving or lifting the monitor, follow these instructions to prevent the monitor from being scratched or damaged and to ensure safe transportation, regardless of its shape or size.

- Place the monitor in the original box or packing material before attempting to move it.
- Before moving or lifting the monitor, disconnect the power cord and all other cables.
- Hold the bottom and side of the monitor frame firmly. Do not hold the panel itself.
- When holding the monitor, the screen should face away from you to prevent it from being scratched.
- When transporting the monitor, do not expose the monitor to shock or excessive vibration.
- When moving the monitor, keep it upright and never turn the monitor on its side or tilt it sideways.

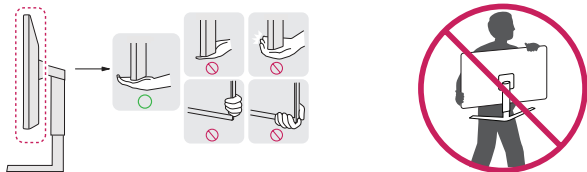

⚠ CAUTION

- Avoid touching the monitor screen as much as possible.
 - This may result in damage to the screen or some of the pixels used to create images.
- If you use the monitor panel without the stand base, its joystick button may cause the monitor to become unstable and fall, resulting in damage to the monitor or human injury. In addition, this may cause the joystick button to malfunction.

Installing on a Table

- Lift the monitor and place it on the table in an upright position. Place the monitor at least 100 mm (3.9 inches) away from the wall to ensure sufficient ventilation.

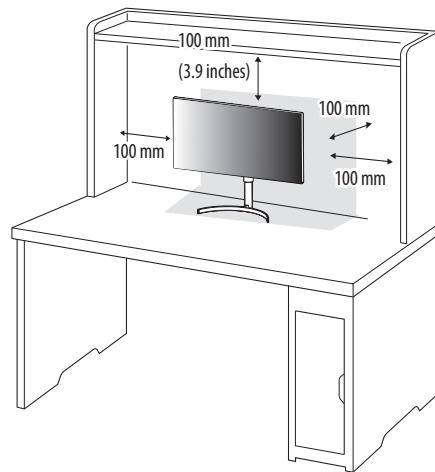

⚠ CAUTION

- Unplug the power cord before moving or installing the monitor. There is risk of electric shock.
- Make sure to use the power cord that is provided in the product package and connect it to a grounded power outlet.
- If you need another power cord, please contact your local dealer or the nearest retail store.

Precautions for Connecting the Power Cord

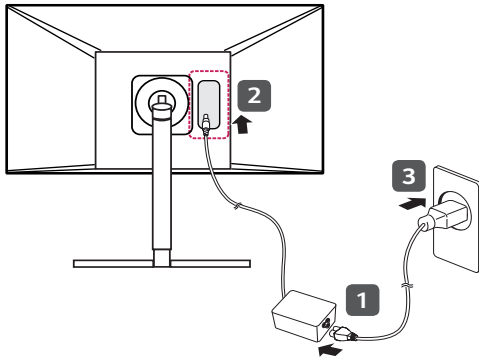

CAUTION

- Make sure to use the power cord that is provided in the product package. Connect the cord to a grounded power outlet.
- If you need another power cord, please contact your local dealer or the nearest retail store.

Adjusting the Stand Height

- 1 Place the monitor mounted on the stand base in an upright position.
- 2 Handle the monitor with both hands for safety.

Max 110.0 mm (4.3 inches)

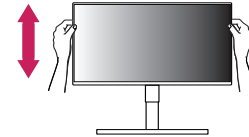

WARNING

- When adjusting the screen height, do not place your hand on the stand body to avoid injury to your fingers.

Adjusting the Angle

- 1 Place the monitor mounted on the stand base in an upright position.
- 2 Adjust the angle of the screen.

NOTE

- The angle of the screen can be adjusted forward or backward from -5° to 20° for a comfortable viewing experience.

WARNING

- To avoid injury to the fingers when adjusting the screen, do not hold the lower part of the monitor's frame as illustrated below.
- Be careful not to touch or press the screen area when adjusting the angle of the monitor.



Pivot Feature

The pivot feature allows the monitor to rotate 90 degrees clockwise or counter-clockwise.

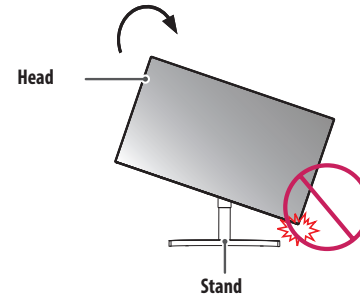

WARNING

- To avoid scratching the stand base, make sure that when rotating the monitor using the pivot feature, the stand does not make contact with the monitor.

- 1 Raise the monitor to the maximum height.



- 2 Adjust the angle of the monitor in the direction of the arrow as shown in the figure.

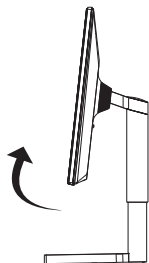

- 3 Rotate the monitor clockwise or counter-clockwise as shown in the figure.

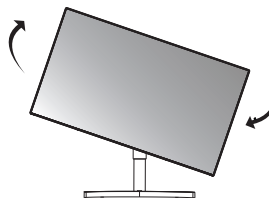

- 4 Complete the installation by rotating the monitor 90° as shown below.



! NOTE

- Auto Pivot feature of the display is not supported.
- The screen can be rotated easily using the screen pivot shortcut key provided with your Windows operating system. Note that some Windows versions and some graphics card drivers may use different settings for the screen pivot key or may not support the pivot key at all.
- Windows screen pivot shortcut keys
 - 0°: Ctrl + Alt + Up arrow key (↑)
 - 90°: Ctrl + Alt + Left arrow key (←)
 - 180°: Ctrl + Alt + Down arrow key (↓)
 - 270°: Ctrl + Alt + Right arrow key (→)

! WARNING

- Take care when rotating the monitor if the cable is connected.
- To avoid injury when rotating the display, do not place your fingers between the display and the stand base.

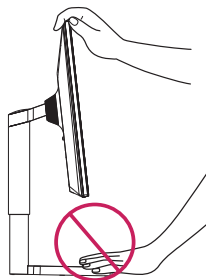
**Using the Kensington Lock**

For more information on installation and usage, refer to the Kensington lock owner's manual or visit the website at <http://www.kensington.com>.

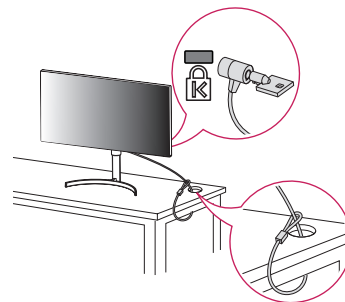
**! NOTE**

- The Kensington Lock is optional. You can obtain optional accessories from most electronics stores.

Installing on the Wall

Install the monitor at least 100 mm (3.9 inches) away from the wall on each side of the monitor to ensure sufficient ventilation. Detailed installation instructions can be obtained from your local dealer. Please refer to the manual to install and set up a tilting wall mounting bracket.

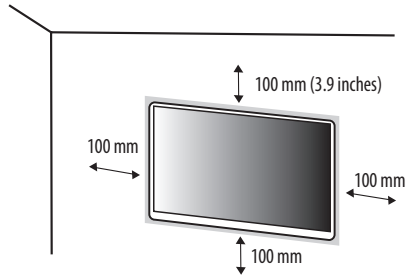

To install the monitor to a wall, attach a wall mount plate (optional) to the back of the monitor. Make sure that the wall mount plate (optional) is securely fixed to the monitor and to the wall.

Installing the Wall Mount Plate

This monitor meets the specifications for the wall mount plate or other compatible devices.

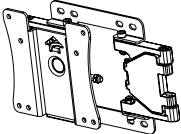
Wall Mount	100 mm x 100 mm (3.9 inches x 3.9 inches)
Standard screw	M4 x L10
Required screws	4
Wall Mount Plate (Optional)	LSW149 

! NOTE

- A non-VESA standard screw may damage the product and cause the monitor to fall. LG Electronics is not liable for any accidents relating to the use of non-standard screws.
- The wall mount kit includes the installation guide and all necessary parts.
- The wall mounting bracket is optional. You can obtain optional accessories from your local dealer.
- The length of the screw may differ for each wall mounting bracket. If you use screws longer than the standard length, it may damage the inside of the product.
- For more information, please refer to the user manual for the wall mounting bracket.
- Be careful not to apply too much force while mounting the wall mount plate as it may cause damage to the screen.
- Remove the stand before installing the monitor on a wall mount by performing the stand attachment in reverse.

⚠ CAUTION

- Disconnect the power cord first. Then move or install the monitor. There is risk of electric shock.
- Installing the monitor on the ceiling or on a slanted wall may result in the monitor falling off, which could lead to injury. Use an authorized LG wall mount and contact the local dealer or qualified personnel.
- To prevent injury, this apparatus must be securely attached to the wall in accordance with the installation instructions.
- Applying excessive force when tightening screws may damage the monitor. Such damage is not covered by the product warranty.
- Use the wall mounting bracket and screws that conform to VESA standards. Damage caused by the use or misuse of inappropriate components is not covered by the product warranty.
- When measured from the back of the monitor, the length of each installed screw must be 8 mm (0.3 inches) or less.

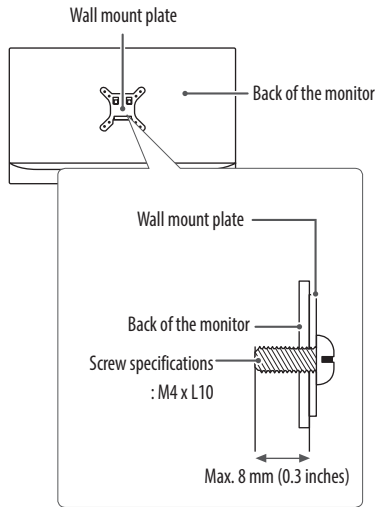

USING THE MONITOR

- Illustrations in this manual may differ from the actual product.

Press the joystick button, go to [Settings] → [Input], and then select the input option.

CAUTION

- Do not press the screen for a prolonged time. This may cause image distortion.
- Do not display a still image on the screen for a prolonged time. This may cause image retention. Use a PC screensaver if possible.
- When connecting the power cord to the outlet, use a grounded (3-hole) power strip or a grounded power outlet.
- The monitor may flicker when turned on in an area where the temperature is low. This is normal.
- Sometimes red, green, or blue spots may appear on the screen. This is normal.

Connecting to a PC

- This monitor supports the *Plug and Play feature.
- * Plug and Play: A feature that allows you to add a device to your computer without having to reconfigure anything or install any manual drivers.

HDMI Connection

Transmits digital video and audio signals from your PC to the monitor.



CAUTION

- Using a DVI to HDMI / DisplayPort to HDMI cable may cause compatibility issues.
- Use a certified cable with the HDMI logo attached. If you do not use a certified HDMI cable, the screen may not display or a connection error may occur.
- Recommended HDMI cable types
 - High-Speed HDMI[®]/TM cable
 - High-Speed HDMI[®]/TM cable with Ethernet

DisplayPort Connection

Transmits digital video and audio signals from your PC to the monitor.



! NOTE

- There may be no video or audio output depending on the DisplayPort version of the PC.
- Make sure to use the supplied DisplayPort cable of the product. Otherwise, this may cause the device to malfunction.
- If you are using a Mini DisplayPort output graphics card, use a Mini DisplayPort to DisplayPort cable or gender that supports DisplayPort1.4. (Sold separately)

Connecting AV Devices

HDMI Connection

HDMI transmits digital video and audio signals from your AV device to the monitor.

! NOTE

- Using a DVI to HDMI / DP (DisplayPort) to HDMI cable may cause compatibility issues.
- Use a certified cable with the HDMI logo attached. If you do not use a certified HDMI cable, the screen may not display or a connection error may occur.
- Recommended HDMI cable types
 - High-Speed HDMI[®]/TM cable
 - High-Speed HDMI[®]/TM cable with Ethernet

Connecting Peripherals

USB Device connection

The USB port on the product functions as a USB hub.

Peripheral devices connected to the USB IN port can be controlled from the PC.



! NOTE

- It is recommended you install all Windows Updates to keep your Windows up-to-date before connecting to the product for use.
- Peripheral devices are sold separately.
- A keyboard, mouse, or USB device can be connected to the USB port.

USER SETTINGS



! NOTE

- Your monitor's OSD (On Screen Display) may differ slightly from that shown in this manual.

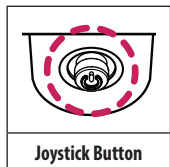
Activating the Main Menu



- 1 Press the joystick button on the bottom of the monitor.
- 2 Move the joystick up/down and left/right to set the options.
- 3 Press the joystick button once more to exit the main menu.

Button	Menu Status	Description	
	Main menu disabled	Enables the main menu.	
	Main menu enabled	Exits the main menu. (Holding down the button more than 5 seconds to turn off the monitor. You can turn off the monitor this way at any time, including when the OSD is on.)	
	◀	Main menu disabled	Enables the main menu.
		Main menu enabled	Enters the [Input] features.
	▶	Main menu disabled	Enables the main menu.
		Main menu enabled	Enters the [Settings] feature.
	▲	Main menu disabled	Displays the information on the current input.
		Main menu enabled	Turns off the monitor.
	▼	Main menu disabled	Displays the information on the current input.
		Main menu enabled	Enters the [Picture Mode] feature.

Main Menu Features

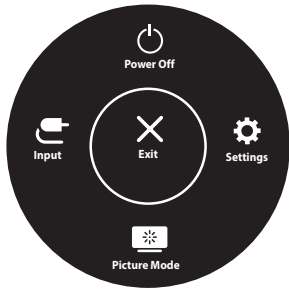

Main Menu	Description
[Input]	Sets input mode.
[Power Off]	Turns off the monitor.
[Settings]	Configures the screen settings.
[Exit]	Exits the main menu.
[Picture Mode]	Sets the Picture mode.

Menu Settings

- 1 To view the OSD menu, press the joystick button at the bottom of the monitor and then enter the [Settings].
- 2 Move the joystick up/down and left/right to set the options.
- 3 To return to the upper menu or set other menu items, move the joystick to ◀ or pressing (⏪) it.
- 4 If you want to exit the OSD menu, move the joystick to ▶ until you exit.



[Quick Settings]



[Input]



[Picture]



[General]

! NOTE

- : On
- : Off

[Quick Settings]

[Settings] > [Quick Settings]	Description
[Brightness] [Contrast]	Adjusts the contrast and brightness of the screen.
[Color Temp]	Set color temperature. ([Custom], [6500K], [7500K], [9300K], [Manual])
[User Preset]	User Preset allows the user to save or load up to 10 picture quality settings for multiple connected devices in each preset.  NOTE <ul style="list-style-type: none">• You can use User Preset to import or save items in [Picture Adjust] and [Color Adjust] of the [Picture] menu.

[Input]

[Settings] > [Input]	Description
[Input List]	Selects the input mode.
[Aspect Ratio]	Adjusts the aspect ratio of the screen.
	[Full Wide] Displays the video in widescreen, regardless of the video signal input.
	[Original] Displays video according to the aspect ratio of the video signal input.
	[Just Scan] The aspect ratio is not adjusted from the original.
	! NOTE <ul style="list-style-type: none">• The display may look the same for [Full Wide], [Original] and [Just Scan] options at the recommended resolution (3840 x 2160).
[Select Resolution]	The recommended resolution of the monitor can be changed to [8MP], [6MP], and [4MP]. ! NOTE <ul style="list-style-type: none">• When the [PBP] mode is activated, the menu is deactivated.
[PBP]	Displays the screens of two input modes on one monitor.
[Main/Sub Screen Change]	Toggles between the main screen and sub screen in [PBP] mode.

[PBP]

[Settings] > [Input]	Description				
[Input List]	Displays the screens of two input modes on one monitor.				
	[Main Input List]	Please refer to the table below for possible PBP combinations.			
	[Sub Input List]				
	PBP Connection		Sub Screen (Right)		
			HDMI	DisplayPort 1	DisplayPort 2
Main Screen (Left)	HDMI	-	0	0	
	DisplayPort 1	0	-	0	
	DisplayPort 2	0	0	-	
[Aspect Ratio]	Adjusts the aspect ratio of the screen.				
	[Main Aspect Ratio]	[Full Wide]	Displays the video to fit the PBP screen, regardless of the video signal input.		
		[Original]	Displays the video in the aspect ratio of the video signal input on the PBP screen.		
	[Sub Aspect Ratio]	[Full Wide]	Displays the video to fit the PBP screen, regardless of the video signal input.		
[Original]		Displays the video in the aspect ratio of the video signal input on the PBP screen.			
[Select Resolution]	<p>The recommended resolution of the monitor can be changed to [8MP], [6MP], and [4MP].</p> <p>! NOTE</p> <ul style="list-style-type: none"> When the [PBP] mode is activated, the menu is deactivated. 				
[PBP]	You can disable the feature that displays images from two input modes simultaneously on one monitor.				
[Main/Sub Screen Change]	Toggles between the main screen and sub screen in [PBP] mode.				

[Picture]**! NOTE**

- The [Picture Mode] that can be set depends on the Input signal.

[Picture Mode] on SDR (Non HDR) signal

[Settings] > [Picture]	Description	
[Picture Mode]	[Custom]	Allows the user to adjust each element.
	[Vivid]	Heightens contrast, brightness and sharpness to display vivid images.
	[HDR Effect]	Optimizes the screen for high dynamic range.
	[Reader]	Optimizes the screen for reading documents. You can brighten the screen in the OSD menu.
	[Mono]	Mono (black and white) color mode.
	[Pathology]	Turn on pathology mode. Image clarity and accuracy as if you were looking at a microscope.
	[DICOM(Clinical)]	A mode that optimizes the screen settings so you can view images for medical use.
	[DICOM(Diagnostic)]	! NOTE <ul style="list-style-type: none"> • The two modes have different levels of brightness.
	[Calibration 1]	Adjusts to the last calibrated screen.
	[Calibration 2]	Adjusts to the previously calibrated screen.
	! NOTE <ul style="list-style-type: none"> • If the [Picture Mode] is changed in the DP (DisplayPort) input, the screen may flicker or the resolution of your PC screen may be affected. • [Calibration 2]: Installation of PerfectLum will enable this menu. 	

[Picture Mode] on HDR signal

[Settings] > [Picture]	Description	
[Picture Mode]	[Custom]	Allows the user to adjust each element.
	[Vivid]	Optimized the screen for HDR vivid colors.
	[Standard]	Optimized the screen for HDR standard.
	! NOTE <ul style="list-style-type: none">• HDR content may not display correctly depending on Windows 10 OS settings, please check HDR On/Off settings in Windows.• When the HDR function is turned on, the characters or picture quality may be poor according to Graphic card performance.• While the HDR function is on, screen flickering or cracking may occur when changing the monitor input or power on/off according to Graphic card performance.	

[Settings] > [Picture]	Description		
[Picture Adjust]	[Brightness]	Adjusts the color contrast and brightness of the screen.	
	[Contrast]		
	[Sharpness]	Adjusts the sharpness of the screen.	
	[Brightness Stabilization]	A function for maintaining a set brightness appropriate for treatment environments.	
		[On]	Automatically adjusts brightness.
		[Off]	Deactivates the applicable function and the user can adjust the brightness.
	[SUPER RESOLUTION+]	[High]	Optimizes the screen for crystal clear images. Best for high-definition video or games.
		[Middle]	Optimizes the screen for comfortable viewing, with images at the middle level between the low and high modes. Best for UCC or SD videos.
		[Low]	Optimizes the screen for smooth and natural images. Best for still images or images with less movement.
		[Off]	Displays in the most common setting. Disables [SUPER RESOLUTION+].
		<p>! NOTE</p> <ul style="list-style-type: none"> Because this is a function to increase the sharpness of low resolution pictures, it is not recommended to use the function for normal text or for desktop icons. Doing so may result in unnecessarily high sharpness. 	
	[Black Level]	Sets the offset level (for HDMI only).	
		<ul style="list-style-type: none"> Offset: as a reference for a video signal, this is the darkest color the monitor can display. 	
		[High]	Keeps the current contrast ratio of the screen.
		[Low]	Lowers the black levels and raises the white levels from the current contrast ratio of the screen.
[DFC]	[On]	Automatically adjusts brightness depending on the screen.	
	[Off]	Deactivates the [DFC] function.	

[Settings] > [Picture]	Description		
[Picture Adjust]	[Response Time]	Sets a response time for displayed pictures based on the movement of the picture on the screen. For a normal environment, it is recommended that you use [Fast]. When there is a lot of motion, it is recommended that you use [Faster]. Setting to [Faster] may cause image sticking.	
		[Faster]	Sets the response time to [Faster].
		[Fast]	Sets the response time to [Fast].
		[Normal]	Sets the response time to [Normal].
		[Off]	Does not use the response time improvement feature.
	[Black Stabilizer]	You can control the black contrast to have better visibility in dark scenes. Increasing the [Black Stabilizer] value brightens the low gray level area on the screen. (You can easily distinguish objects on dark game screens.) Reducing the [Black Stabilizer] value darkens the low gray level area and increases the dynamic contrast on the screen.	
	[Uniformity]	Automatically adjusts the brightness uniformity of the screen. ! NOTE • If [Uniformity] is activated, the screen may become darker.	
		[On]	Activates the [Uniformity] function.
		[Off]	Deactivates the [Uniformity] function.

[Settings] > [Picture]	Description		
[Color Adjust]	[Gamma]	Set gamma value. ([Gamma 1.8], [Gamma 2.0], [Gamma 2.2], [Gamma 2.4], [Gamma 2.6], [DICOM Gamma Curve]) Higher gamma settings mean a darker image is displayed or vice versa.	
	[Color Temp]	Set color temperature.	
		[Custom]	The user can customize the red, green and blue color.
		[6500K]	Sets the picture color to the color temperature of a reddish 6500K.
		[7500K]	Sets the picture color to the color temperatures of 7500K, setting to a color between red and blue.
		[9300K]	Sets the picture color to the color temperature of a bluish 9300K.
	[Manual]	Adjusts the color temperature in 500K increments. (Note that 9300K is supported rather than 9500K.)	
	[Red], [Green], [Blue]	You can customize the picture color using [Red], [Green], and [Blue] colors.	
	[Six Color]	Meets the user requirements for colors by adjusting the hue and saturation of the six colors (red, green, blue, cyan, magenta, and yellow) and then saving the settings.	
		Hue	Adjusts the tone of the screen colors.
Saturation		Adjusts the saturation of the screen colors. The lower the value, the less saturated and brighter the colors become. The higher the value, the more saturated and darker the colors become.	
[Picture Reset]	[Do you want to reset your picture settings?]	[Yes]	Returns color to the default settings.
		[No]	Cancel the select.

[General]

[Settings] > [General]	Description	
[Language]	Sets the menu screen to the desired language.	
[SMART ENERGY SAVING]	Conserve energy by using luminance compensation algorithm.	
	[High]	Saves energy using the high-efficiency [SMART ENERGY SAVING] feature.
	[Low]	Saves energy using the low-efficiency [SMART ENERGY SAVING] feature.
	[Off]	Disables the feature.
[Power LED]	Turns the power LED on the front of the monitor on or off.	
	<p>! NOTE</p> <ul style="list-style-type: none"> When the Power LED function is turned on, it operates as follows: <ul style="list-style-type: none"> On Mode: White Sleep Mode: White Blinking Off Mode: Off 	
[Automatic Standby]	Feature that automatically turns off the monitor when there is no movement on the screen for a period of time. You can set a timer for the auto-off function. ([8H], [6H], [4H], and [Off])	
[User Preset]	<p>User Preset allows the user to save or load up to 10 picture quality settings for multiple connected devices in each preset.</p> <p>! NOTE</p> <ul style="list-style-type: none"> You can use User Preset to import or save items in [Picture Adjust] and [Color Adjust] of the [Picture] menu. 	
[DisplayPort Version]	DisplayPort 1	Set DisplayPort Version to the same version as the connected external device. ([1.4], [1.2], and [1.1]) To use the HDR function, set to [1.4].
	DisplayPort 2	Set DisplayPort Version to the same version as the connected external device. ([1.4], [1.2], and [1.1]) To use the HDR function, set to [1.4].

[Settings] > [General]	Description			
[HDMI ULTRA HD Deep Color]	Provides sharper images when connected to a device supporting [HDMI ULTRA HD Deep Color].			
	4K @ 60 Hz Support Format			
	Resolution	Frame rate (Hz)	Color Depth / Chroma Sampling	
			8 bit	10 bit
	3840 x 2160	59.94	YCbCr 4:2:0	
			YCbCr 4:2:2	
		60.00	YCbCr 4:4:4	-
RGB 4:4:4			-	
<p>! NOTE</p> <ul style="list-style-type: none"> • To use [HDMI ULTRA HD Deep Color], turn this function on. • If the connected device does not support [HDMI ULTRA HD Deep Color], the screen or sound may not work properly. In this case, set this function to off. 				
[Buzzer]	This feature lets you set the sound generated from Buzzer when your monitor powers on to on or off.			
	[On]	Enables your monitor's buzzer.		
	[Off]	Disables your monitor's buzzer.		
[OSD Lock]	This feature disables the configuration and adjustment of menus.			
[Information]	The following display information will be shown; [Serial Number], [Total Power On Time], [Resolution], [PerfectLum Serial Number].			
[Reset to Initial Settings]	[Do you want to reset your settings?]	[Yes]	Returns to the default settings.	
		[No]	Cancel the reset.	

TROUBLESHOOTING

Nothing is displayed on the screen.

Problem	Action
Is the monitor's power cord plugged in?	<ul style="list-style-type: none">• Check if the power cord is correctly plugged into the power outlet.
Is the power LED on?	<ul style="list-style-type: none">• Check the power cable connection and press the power button.
Is the power on and the power LED displaying white?	<ul style="list-style-type: none">• Check that the connected input is enabled ([Settings] > [Input]).
Is the [No Signal] message being displayed?	<ul style="list-style-type: none">• This is displayed when the signal cable between the PC and the monitor is missing or disconnected. Check the cable and reconnect it.
Is the [Out of Range] message being displayed?	<ul style="list-style-type: none">• This occurs when signals transferred from the PC (graphics card) are out of the horizontal or vertical frequency range of the monitor. Please see the < PRODUCT SPECIFICATIONS> section of this manual to set the appropriate frequency.

Screen display is unstable and shaky. / Images displayed on the monitor leave shadow trails.

Problem	Action
Did you select the appropriate resolution?	<ul style="list-style-type: none"> • If the selected resolution is HDMI 1080i 60/50 Hz (interlaced), the screen may be flickering. Change the resolution to 1080p or the recommended resolution. • Not setting the graphics card to the recommended (optimal) resolution may result in blurred text, a dimmed screen, a truncated display area or misalignment of the display. • The setting methods may be different depending on the computer or operating system, and some resolutions may not be available depending on the performance of the graphics card. If this is the case, contact the manufacturer of the computer or graphics card for assistance.
Does image sticking occur even when the monitor is turned off?	<ul style="list-style-type: none"> • Displaying a still image for a prolonged time may cause damage to the screen, resulting in the retention of the image. • To extend the lifetime of the monitor, use a screensaver.
Are there spots on the screen?	<ul style="list-style-type: none"> • When using the monitor, pixilated spots (red, green, blue, white, or black) may appear on the screen. This is normal for an LCD screen. It is not an error, nor is it related to the monitor's performance.

Some features are disabled.

Problem	Action
Are some functions not available when you press the Menu button?	<ul style="list-style-type: none"> • The OSD is locked. Disable [OSD Lock] in [General].

4K resolution is unavailable.

Problem	Action
Did you check the cable connection?	<ul style="list-style-type: none">• Check if the cable is properly connected.• It is recommended to use the accessories supplied with the product.
Is the resolution and refresh rate set properly?	<ul style="list-style-type: none">• Set the proper resolution and refresh rate in the PC screen resolution settings or the player's option menu.
Does the connected external device support 4K resolution?	<ul style="list-style-type: none">• It is available only on external devices that support 4K resolution.• Check if the connected external device supports 4K resolution.
Is the [HDMI ULTRA HD Deep Color] function enabled?	<ul style="list-style-type: none">• Go to [Settings] > [General] > [HDMI ULTRA HD Deep Color] function to enable the function.

PRODUCT SPECIFICATIONS

In order to improve the product, specifications may change without notice.

The ~ symbol means alternating current, and the symbol — means direct current.

LCD Screen	Type	TFT (Thin Film Transistor) LCD (Liquid Crystal Display) Screen	
	Pixel Pitch	0.18159 mm x 0.18159 mm	
Resolution	Max Resolution	3840 x 2160 @ 60 Hz	
	Recommended Resolution	3840 x 2160 @ 60 Hz	
Video Signal	Horizontal Frequency	30 kHz to 135 kHz	
	Vertical Frequency	56 Hz to 61 Hz	
Input Connector	USB IN 1, USB IN 2, USB UP, DP IN 1, DP IN 2, HDMI IN, DC-IN		
Power Sources	Power Rating	19 V — = 3.42 A	
	Power Consumption	MAX. 65 W * Sleep Mode: ≤ 0.5 W Off Mode: ≤ 0.3 W	
AC-DC Adaptor	DA-65J19 type, manufactured by Asian Power Devices Inc. (APD) Input: 100-240 V~ 50-60 Hz, 1.5-0.7 A Output: 19 V — = 3.42 A Classification by protection type against Electric Shock: Class I		
Environmental Conditions	Operating Conditions	Temperature	0 °C to 40 °C (32 °F to 104 °F)
		Humidity	0 % to 80 %
		Pressure	700 hPa to 1060 hPa
	Storage / Transport Conditions	Temperature	-20 °C to 60 °C (-4 °F to 140 °F)
		Humidity	0 % to 85 %
		Pressure	500 hPa to 1060 hPa

Monitor Size			
Dimensions (Width x Height x Depth)	With Stand	718.2 x 590.0 x 231.2 (mm)	28.2 x 23.2 x 9.1 (inches)
	Without Stand	718.2 x 414.3 x 45.1 (mm)	28.2 x 16.3 x 1.7 (inches)
Weight	With Stand	7.0 (kg)	15.4(lbs)
	Without Stand	5.6 (kg)	12.3(lbs)

Medical Specifications	Classification by protection type against Electric Shock	Class I equipment
	Mode of operation	Continuous Operation
	Environment of Use	This equipment is not suitable for use in the presence of flammable anesthetic or oxygen.

- * The Operating Mode of Power Consumption is measured with LGE test standard. (Full White pattern, Maximum resolution)
- * The Power Consumption level can be different by operating condition and monitor setting.

Support Mode (Preset Mode - PC)

DisplayPort / HDMI

Resolution	Horizontal Frequency (kHz)	Vertical Frequency (Hz)	Polarity (H/V)	Remarks
640 x 480	31.469	59.94	-/-	
800 x 600	37.879	60.317	+/+	
1024 x 768	48.363	60	-/-	
1152 x 864	54.347	60.05	+/+	
1200 x 1600	99.48	60	-/+	
1280 x 720	45	60	+/+	
1280 x 800	49.702	59.81	-/+	
1280 x 1024	63.981	60.02	+/+	
1280 x 1440	89.58	60	-/+	
1440 x 1280	79.62	60	-/+	
1536 x 2048	127.26	60	-/+	
1600 x 900	60	60	+/+	
1600 x 1200	74.7	60	-/+	
1600 X 1800	111.9	60	-/+	
1800 X 1600	99.48	60	-/+	
1920 x 1080	67.5	60	+/+	
1920 x 2160	133.29	59.99	+/-	PBP (Landscape view)
2048 x 1536	95.52	60	-/+	
2160 x 1920	118.5	60	+/-	PBP (Portrait view)
2560 x 1440	44.43	30	+/-	

Resolution	Horizontal Frequency (kHz)	Vertical Frequency (Hz)	Polarity (H/V)	Remarks
2560 x 1440	88.79	59.95	+/-	
3200 x 1800	54.95	29.96	+/-	
3200 x 1800	111.82	59.96	+/-	
3840 x 2160 ¹⁾	67.5	30	+/+	
3840 x 2160 ¹⁾	135	60	+/+	When [HDMI ULTRA HD Deep Color] is set to [On] / HDMI Recommend.
3840 x 2160 ²⁾	66.66	30	+/-	
3840 x 2160 ²⁾	133.32	60	+/-	DisplayPort Recommend

*1) For HDMI, 2) For DP

Support Mode (Video)

Vertical dimensions	Horizontal Frequency (kHz)	Vertical Frequency (Hz)
480P	31.5	60
720P	45	60
1080P	67.5	60
2160P	135	60

Power indicator

Mode	LED Color
On Mode	White
Sleep Mode	Flashing White
Off Mode	Off

Supported Graphic Card List

Vendor	Graphic Card
NVIDIA	Quadro series
AMD	FirePro series



WARNING: This equipment is compliant with Class A of CISPR 32. In a residential environment this equipment may cause radio interference.

Read the user manual (CD) carefully and keep it at hand. The product label contains necessary information for after-service.

Model

Serial No.

Supplier's Declaration of Conformity

Trade Name	LG
Responsible Party	LG Electronics USA, Inc.
Address	111 Sylvan Avenue, North Building, Englewood Cliffs, NJ 07632
E-mail	lg.environmental@lge.com