



OWNER'S MANUAL

# LG Gaming Monitor (LED MONITOR\*)

\* LG LED Monitor applies LCD screen with LED backlights.

Please read this manual carefully before operating your set and retain it for future reference.

34GN850

34GN85B

34GP83A

# TABLE OF CONTENTS

## LICENSE..... 3

## ASSEMBLING AND PREPARING 4

- Supported Drivers and Software ..... 4
- Product and Button Description..... 5
  - How to Use the Joystick Button
- Moving and Lifting the Monitor..... 6
  - Installing on a Table
  - Adjusting the Stand Height
  - Adjusting the Angle
  - Tidying up Cables
  - Using the Kensington Lock
  - Installing the Wall Mount Plate
  - Installing on the Wall

## USING THE MONITOR..... 14

- Connecting to a PC..... 14
  - HDMI Connection
  - DisplayPort Connection
- Connecting AV Devices..... 15

- HDMI Connection
  - Connecting Peripherals..... 16
- USB Cable connection
- Connecting Headphones

## USER SETTINGS ..... 17

- Activating the Main Menu ..... 17
  - Main Menu Features
- User Settings ..... 19
  - Menu Settings

## TROUBLESHOOTING..... 30

## PRODUCT SPECIFICATION ..... 33

- Factory Support Mode..... 35
- HDMI Timing (Video)..... 36

# LICENSE

Each model has different licenses. Visit [www.lg.com](http://www.lg.com) for more information on the license.



The terms HDMI and HDMI High-Definition Multimedia Interface, and the HDMI Logo are trademarks or registered trademarks of HDMI Licensing Administrator, Inc.



The SuperSpeed USB Trident logo is a registered trademark of USB Implementers Forum, Inc.

# ASSEMBLING AND PREPARING

## CAUTION

- Always use genuine LG components to ensure safety and product performance.
- The product warranty will not cover damage or injury caused by the use of unauthorized components.
- It is recommended that use the supplied components.
- If you use generic cables not certified by LG, the screen may not display or there may be image noises.
- Illustrations in this document represent typical procedures, so they may look different from the actual product.
- Do not apply foreign substances (oils, lubricants, etc.) to the screw parts when assembling the product. (Doing so may damage the product.)
- Applying excessive force when tightening screws may cause damage to the monitor. Damage caused in this way will not be covered by the product warranty.
- Do not carry the monitor upside down by just holding the base. This may cause the monitor to fall off the stand and could result in personal injury.
- When lifting or moving the monitor, do not touch the monitor screen. The force applied to the monitor screen may cause damage to it.
- For wave pattern on appearance, unlike the general method of coating, it's applied to added glittering material in raw material. With no peeled-off appearance, it has good durability. Please use it with confidence because there is no problem in using the product at all.

## NOTE

- The components may look different from those illustrated here.
- Without prior notice, all product information and specifications contained in this manual are subject to change to improve the performance of the product.
- To purchase optional accessories, visit an electronics store or an online shopping site, or contact the retailer from which you purchased the product.
- The power cord provided may differ depending upon the region.

## Supported Drivers and Software

You can download and install the latest version from the LGE website ([www.lg.com](http://www.lg.com)).

| Drivers and Software | Installation Priority |
|----------------------|-----------------------|
| Monitor Driver       | Recommended           |
| OnScreen Control     | Recommended           |

## Product and Button Description



Joystick Button / Power LED

- On: Power on
- Off: Power off

## How to Use the Joystick Button

You can easily control the functions of the monitor by pressing the joystick button or moving it left/right with your finger.

### Basic Functions

|  |  |                                   |   |
|--|--|-----------------------------------|---|
|  |  | <b>Power on</b>                   | Press the joystick button once with your finger to turn on the monitor.           |
|  |  | <b>Power off</b>                  | Press and hold the joystick button once with your finger to turn off the monitor. |
|  |  | <b>Volume control</b>             | You can control the volume by moving the joystick button left/right.              |
|  |  | <b>Controls screen brightness</b> | You can control the screen's brightness by moving the joystick button up/down.    |

### NOTE

- The joystick button is located at the bottom of the monitor.

## Moving and Lifting the Monitor

When moving or lifting the monitor, follow these instructions to prevent the monitor from being scratched or damaged and to ensure safe transportation, regardless of its shape or size.

- Place the monitor in the original box or packing material before attempting to move it.
- Before moving or lifting the monitor, disconnect the power cord and all other cables.
- Hold the bottom and side of the monitor frame firmly. Do not hold the panel itself.

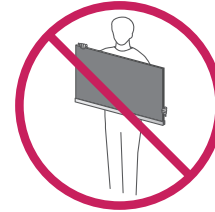
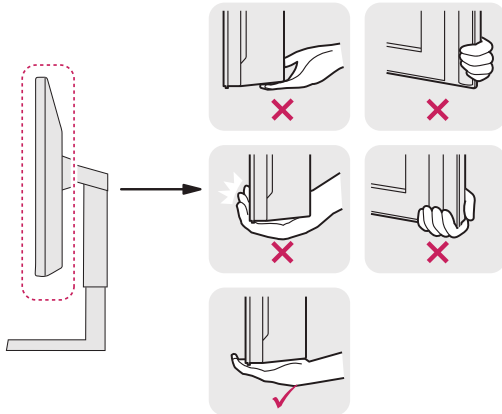

- When holding the monitor, the screen should face away from you to prevent it from being scratched.
- When transporting the monitor, do not expose the monitor to shock or excessive vibration.
- When moving the monitor, keep it upright and never turn the monitor on its side or tilt it sideways.

### CAUTION

- Avoid touching the monitor screen as much as possible.
  - This may result in damage to the screen or some of the pixels used to create images.

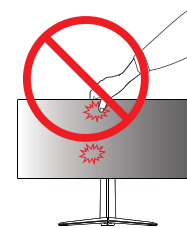

- If you use the monitor panel without the stand base, its joystick button may cause the monitor to become unstable and fall, resulting in damage to the monitor or human injury. In addition, this may cause the joystick button to malfunction.

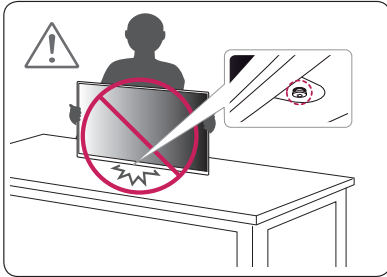

## Installing on a Table

- 1 Lift the monitor and place it on the table in an upright position. Place the monitor at least 100 mm (3.94 inches) away from the wall to ensure sufficient ventilation.

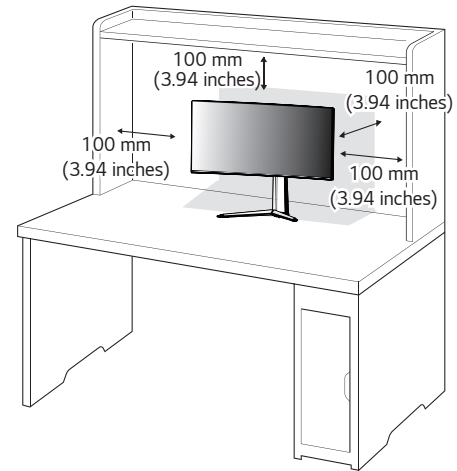

## Adjusting the Stand Height

- 1 Place the monitor mounted on the stand base in an upright position.
- 2 Handle the monitor with both hands for safety.

Max. 110.0 mm (4.3 inches)

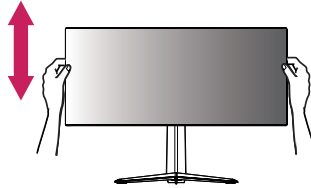

### WARNING

- When adjusting the screen height, do not place your hand on the stand body to avoid injury to your fingers.



## Adjusting the Angle

- 1 Place the monitor mounted on the stand base in an upright position.
- 2 Adjust the angle of the screen.

The angle of the screen can be adjusted forward or backward from  $-5^{\circ}$  to  $15^{\circ}$  for a comfortable viewing experience.

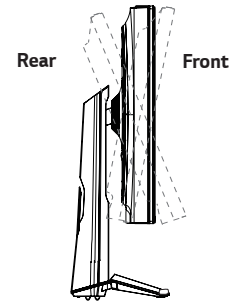



## ! WARNING

- To avoid injury to the fingers when adjusting the screen, do not hold the lower part of the monitor's frame as illustrated below.

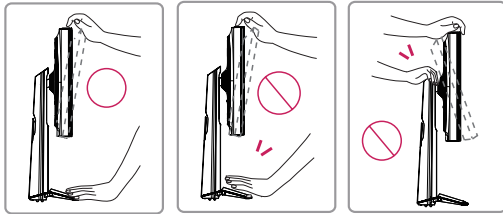

- Be careful not to touch or press the screen area when adjusting the angle of the monitor.

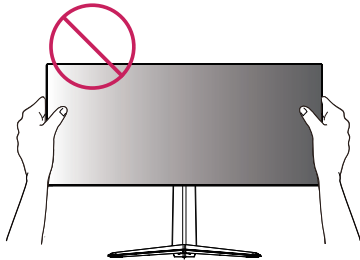

## ! NOTE

- The left or right side of the monitor head can be slightly rotated up or down (up to 3°). Adjust the horizontal level of the monitor head.

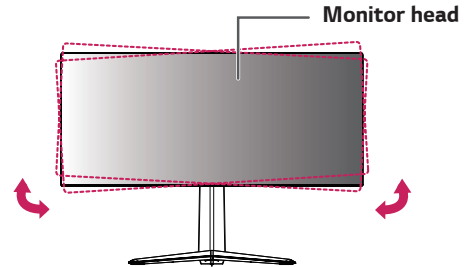

## Tidying up Cables

Arrange the cables using the cable holder as shown in the illustration.

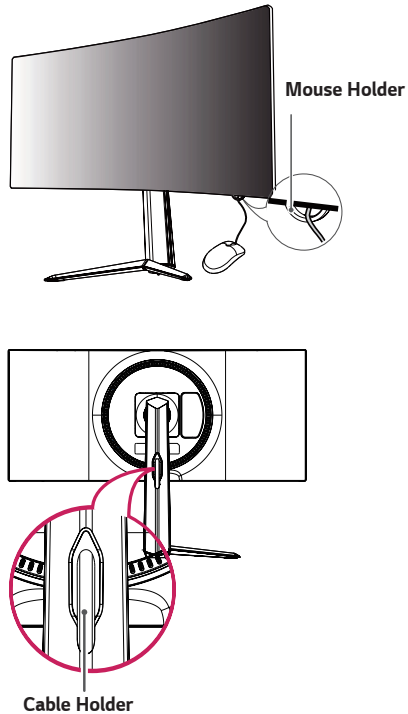

## Using the Kensington Lock

The connector for the Kensington security system is located at the bottom of the monitor.

For more information on installation and usage, refer to the Kensington lock owner's manual or visit the website at <http://www.kensington.com>.

Connect the monitor to a table using the Kensington security system cable.

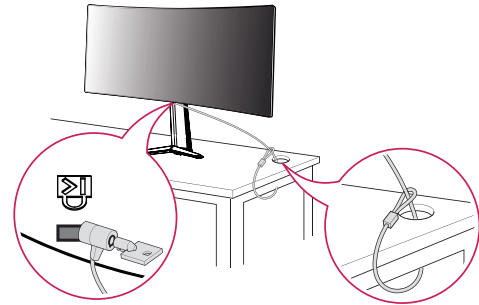

### ! NOTE

- The Kensington security system is optional. You can obtain optional accessories from most electronics stores.

## Installing the Wall Mount Plate

This monitor meets the specifications for the wall mount plate or other compatible devices.

- 1 Place the screen face down. To protect the monitor panel (screen), cover the surface with a soft cloth or the monitor protection pad included in the product package.
- 2 Remove the four screws tightened on the back of the monitor.
- 3 Place the wall mount plate onto the monitor and align it with the screw holes.
- 4 Tighten the four screws using a screwdriver to fix the plate to the monitor.

### NOTE

- The wall mount plate is sold separately.
- For more information on installation, refer to the wall mount plate's installation guide.
- Be careful not to apply too much force while mounting the wall mount plate as it may cause damage to the screen.

## Installing on the Wall

Install the monitor at least 100 mm (3.94 inches) away from the wall and leave about 100 mm (3.94 inches) of space at each side of the monitor to ensure sufficient ventilation. Detailed installation instructions can be obtained from your local retail store. Alternatively, please refer to the manual for how to install and set up a tilting wall mounting bracket.

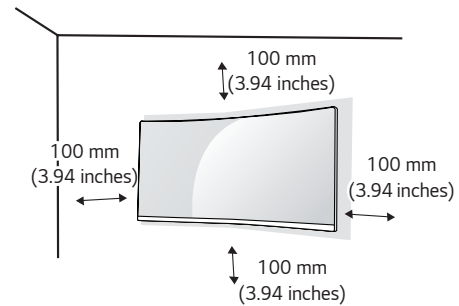

To install the monitor to a wall, attach a wall mounting bracket (optional) to the back of the monitor:

Make sure that the wall mounting bracket is securely fixed to the monitor and to the wall.

- 1 If you use screws longer than the standard length, it may damage the inside of the product.
- 2 A non-VESA standard screw may damage the product and cause the monitor to fall. LG Electronics is not liable for any accidents relating to the use of non-standard screws.

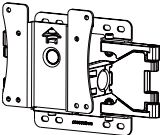
|                                    |  |
|------------------------------------|--|
| <b>Wall Mount (mm)</b>             | 100 x 100  |
| <b>Standard screw</b>              | M4 x L10   |
| <b>Number of screws</b>            | 4  |
| <b>Wall Mount Plate (Optional)</b> | LSW 149<br> |

### NOTE

- Use the screws specified by VESA standards.
- The wall mount kit includes the installation guide and all necessary parts.
- The wall mounting bracket is optional. You can obtain optional accessories from your local dealer.
- The length of the screw may differ for each wall mounting bracket. Be sure to use the proper length.
- For more information, please refer to the user manual for the wall mounting bracket.

### CAUTION

- Unplug the power cord before moving or installing the monitor to avoid electric shock.
- Installing the monitor on the ceiling or on a slanted wall may result in the monitor falling off, which could lead to injury. Use an authorized LG wall mount and contact the local dealer or qualified personnel.
- Applying excessive force when tightening screws may cause damage to the monitor. Damage caused in this way will not be covered by the product warranty.

- Use the wall mounting bracket and screws that conform to VESA standards. Damage caused by the use or misuse of inappropriate components will not be covered by the product warranty.
- When measured from the back of the monitor, the length of each installed screw must be 8 mm (0.3 inches) or less.

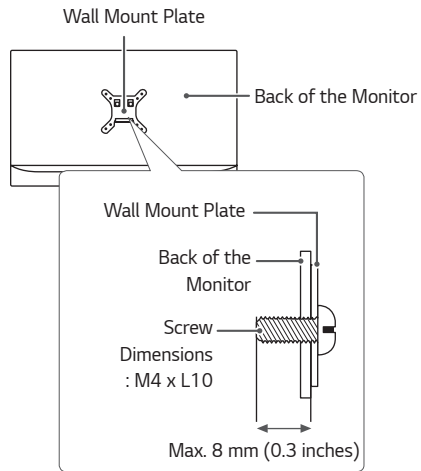

## USING THE MONITOR

- Illustrations in this manual may differ from the actual product. Press the joystick button, go to **Menu** → **Input**, and then select the input option.



### CAUTION

- Do not press the screen for a prolonged time. This may cause image distortion.
- Do not display a still image on the screen for a prolonged time. This may cause image retention. Use a screensaver if possible.



### NOTE

- When connecting the power cord to the outlet, use a grounded (3-hole) power strip or a grounded power outlet.
- The monitor may flicker when turned on in an area where the temperature is low. This is normal.
- Sometimes red, green, or blue spots may appear on the screen. This is normal.

## Connecting to a PC

- This monitor supports the \*Plug and Play feature.
- \* Plug and Play: A feature that allows you to add a device to your computer without having to reconfigure anything or install any manual drivers.

### HDMI Connection

Transmits digital video and audio signals from your PC to the monitor.



### CAUTION

- Using a DVI to HDMI / DP (DisplayPort) to HDMI cable may cause compatibility issues.
- Use a certified cable with the HDMI logo attached. If you do not use a certified HDMI cable, the screen may not display or a connection error may occur.
- Recommended HDMI cable types
  - High-Speed HDMI<sup>®</sup>/TM cable
  - High-Speed HDMI<sup>®</sup>/TM cable with Ethernet

## DisplayPort Connection

Transmits digital video and audio signals from your PC to the monitor.

### NOTE

- There may be no video or audio output depending on the DP (DisplayPort) version of the PC.
- If you are using a Mini DisplayPort output graphics card, use a Mini DP to DP (Mini DisplayPort to DisplayPort) cable or gender that supports DisplayPort 1.2 or 1.4. (Sold separately)

## Connecting AV Devices

### HDMI Connection

HDMI transmits digital video and audio signals from your AV device to the monitor.

### NOTE

- Using a DVI to HDMI / DP (DisplayPort) to HDMI cable may cause compatibility issues.
- Use a certified cable with the HDMI logo attached. If you do not use a certified HDMI cable, the screen may not display or a connection error may occur.
- Recommended HDMI cable types
  - High-Speed HDMI®/™ cable
  - High-Speed HDMI®/™ cable with Ethernet

## Connecting Peripherals

### USB Cable connection

The USB port on the product functions as a USB hub.

To use USB 3.0, connect the A-B type USB 3.0 cable of the product to the PC. Peripheral devices connected to the USB IN port can be controlled from the PC.

#### NOTE

- Make sure to install the most recent Windows OS service pack before using the product.
- Peripheral devices are sold separately.
- A keyboard, mouse, or USB device can be connected to the USB port.

#### CAUTION

Cautions When Using a USB Device

- A USB device with an automatic recognition program installed, or that uses its own driver, may not be recognized.
- Some USB devices may not be supported or may not work properly.
- It is recommended to use a USB hub or hard disk drive with power supplied. (If the power supply is not adequate, the USB device may not be recognized properly.)

### Connecting Headphones

Connect peripherals to the monitor via the headphones port.

#### NOTE

- Peripheral devices are sold separately.
- If you use angled earphones, it may cause a problem with connecting another external device to the monitor. Therefore, it is recommended to use straight earphones.



Angled

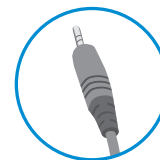

Straight

- Depending on the audio settings of the PC and external device, headphones and speaker functions may be limited.





# USER SETTINGS

## Activating the Main Menu

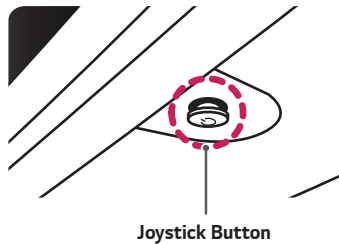
- 1 Press the joystick button on the bottom of the monitor.
- 2 Move the joystick up/down (▲/▼) and left/right (◀/▶) to set the options.
- 3 Press the joystick button once more to exit the main menu.

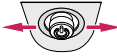

| Button  | Menu Status               | Description   |
|---|---------------------------|---|
|  | <b>Main menu disabled</b> | Enables the main menu.  |
|   | <b>Main menu enabled</b>  | Exits the main menu.<br>(Holding down the button to turn off the monitor. You can turn off the monitor this way at any time, including when the OSD is on.) |
|  | <b>Main menu disabled</b> | Adjusts the monitor volume level.   |
|   | <b>Main menu enabled</b>  | Enters the <b>Input</b> features.   |
|   | <b>Main menu disabled</b> | Adjusts the monitor volume level.   |
|   | <b>Main menu enabled</b>  | Enters the <b>Menu</b> feature.   |
|  | <b>Main menu disabled</b> | Adjusts the monitor brightness level.   |
|   | <b>Main menu enabled</b>  | Turns off the monitor.  |
|   | <b>Main menu disabled</b> | Adjusts the monitor brightness level.   |
|   | <b>Main menu enabled</b>  | Enters the <b>Game Mode</b> feature.  |

## Main Menu Features

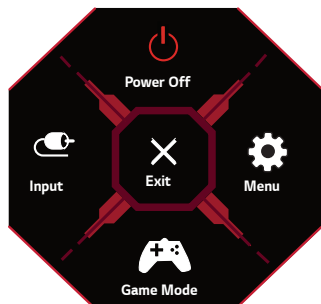

| Main Menu        | Description                     |
|------------------|---------------------------------|
| <b>Input</b>     | Sets input mode.                |
| <b>Power Off</b> | Turns off the monitor.          |
| <b>Menu</b>      | Configures the screen settings. |
| <b>Game Mode</b> | Sets the game mode for gaming.  |
| <b>Exit</b>      | Exits the main menu.            |

# User Settings

## Menu Settings

- 1 To view the settings menu, press the joystick button at the bottom of the monitor and then enter the **Menu**.
- 2 Configure the options by moving the joystick up/down/left/right.
- 3 To return to the upper settings or set other settings items, move the joystick to ◀ or press (⏪).
- 4 If you want to exit the settings menu, move the joystick to ◀ until you exit.



Game Mode



Game Adjust



Picture Adjust



Input





General

Game Mode on SDR(Non-HDR)signal.

| Menu > Game Mode |                   | Description  |
|------------------|-------------------|--|
| Game Mode        | <b>Gamer 1</b>    | In this mode, users can customize elements including game-related options.   |
|                  | <b>Gamer 2</b>    | <b>Gamer 1</b> and <b>Gamer 2</b> picture modes allow you to save two sets of customized display settings, including game-related setup options. |
|                  | <b>FPS</b>        | This mode is optimized for FPS games.It is suitable for very dark FPS games.   |
|                  | <b>RTS</b>        | This mode is optimized for RTS Game.   |
|                  | <b>Vivid</b>      | Optimized the screen for vivid colors.   |
|                  | <b>Reader</b>     | Optimizes the screen for viewing documents. You can brighten the screen in the settings menu.  |
|                  | <b>HDR Effect</b> | Optimizes the screen for high dynamic range.   |
|                  | <b>sRGB</b>       | A standard RGB color space for the monitor and printer.  |

Game Mode on HDR signal.

| Menu > Game Mode |   | Description  |
|------------------|---|--|
| Game Mode        | <b>Gamer 1</b>  | In this mode, users can customize elements including game-related options.   |
|                  | <b>Gamer 2</b>  | <b>Gamer 1</b> and <b>Gamer 2</b> picture modes allow you to save two sets of customized display settings, including game-related setup options. |
|                  | <b>FPS</b>  | This mode is optimized for FPS games. It is suitable for very dark FPS games.  |
|                  | <b>RTS</b>  | This mode is optimized for RTS Game.   |
|                  | <b>Vivid</b>  | Optimized the screen for vivid colors.   |
|                  |  <b>NOTE</b> <ul style="list-style-type: none"> <li>• HDR content may not be operated properly depending on the Windows10 OS setting. Please check the HDR On / Off setting of Windows.</li> <li>• When the HDR function is turned on, the characters or picture quality may be poor according to Graphic card performance.</li> <li>• While the HDR function is on, screen flickering or cracking may occur when changing the monitor input or power on/off according to Graphic card performance.</li> <li>• For information about whether the graphics card and game support HDR, visit their manufacture's website.</li> </ul> |  |

| Menu > Game Adjust |           | Description  |   |
|--------------------|-----------|--|---|
| Game Adjust        | Overclock | On   | Sets <b>Overclock</b> to a higher refresh rate than specified by the panel specification. |
|                    |           | Off  | Disables the <b>Overclock</b> improvement feature.  |
|                    |           | <p> <b>NOTE</b></p> <ul style="list-style-type: none"> <li>• After the monitor reboots, change the maximum refresh rate setting in the GPU control panel.</li> <li>• If the screen display appears abnormal, turn off the <b>Overclock</b> setting.</li> <li>• The function can only be used through DisplayPort.</li> <li>• The <b>Overclock</b> function's features/performance may vary depending on the graphics card or gaming content.</li> <li>• We do not guarantee the performance of the function and are not responsible for any side effects that may occur from its activation.</li> </ul> |   |

|                    |                         |  |                                   |
|--------------------|-------------------------|--|-----------------------------------|
| <b>Game Adjust</b> | <b>Adaptive-Sync</b>    | Provides seamless and natural images by synchronizing the vertical frequency of the input signal with that of the output signal.   |                                   |
|                    |                         |  <b>CAUTION</b> <ul style="list-style-type: none"> <li>In HDMI input, the menu name is displayed as certified AMD FreeSync Tier name instead of <b>Adaptive-Sync</b>. (<b>FreeSync / FreeSync Premium / FreeSync Premium Pro</b>)</li> <li>Supported Interface: DisplayPort (<b>Adaptive-Sync</b>), HDMI (<b>FreeSync</b>).</li> <li>Supported Graphic Card : A graphic card that supports NVIDIA's G-SYNC or AMD's FreeSync is necessary.</li> <li>Supported Version : Make sure to update the graphic card to the latest driver.</li> <li>For more information and requirement, refer to NVIDIA website (<a href="http://www.nvidia.com">www.nvidia.com</a>) and AMD website (<a href="http://www.amd.com">www.amd.com</a>).</li> </ul> |                                   |
|                    |                         | <b>On</b>  | <b>Adaptive-Sync</b> function on. |
|                    | <b>Off</b>              | <b>Adaptive-Sync</b> function off.   |                                   |
|                    | <b>Black Stabilizer</b> | <p>You can control the black contrast to have better visibility in dark scenes.</p> <p>You can easily distinguish objects on dark game screens.</p>  |                                   |



|                    |                      |  |                                   |
|--------------------|----------------------|--|-----------------------------------|
| <b>Game Adjust</b> | <b>Response Time</b> | Sets a response time for displayed pictures based on the speed of the screen.<br>For a normal environment, it is recommended that you use <b>Fast</b> .<br>For a fast-moving picture, it is recommended that you use <b>Faster</b> .<br>Setting to <b>Faster</b> may cause image sticking.                       |                                   |
|                    |                      | <b>Faster</b>  | Sets the response time to Faster. |
|                    |                      | <b>Fast</b>  | Sets the response time to Fast.   |
|                    |                      | <b>Normal</b>  | Sets the response time to Normal. |
|                    | <b>Off</b>           | Does not use the response time improvement feature.  |                                   |
|                    | <b>Cross Hair</b>    | Cross hair provides a mark on the center of the screen for First Person Shooter (FPS) games. Users can select the cross hair that fits their gaming environment among four different cross hairs.<br>• When the monitor is off or enters energy saving mode, the cross hair feature is automatically turned off. |                                   |
|                    | <b>Game Reset</b>    | <b>No</b>  | Cancel the select.                |
| <b>Yes</b>         |                      | Returns to the default settings.   |                                   |





| Menu > Picture Adjust |                   | Description   |   |
|-----------------------|-------------------|---|---|
| Picture Adjust        | <b>Brightness</b> | Adjusts the brightness of the screen.   |   |
|                       | <b>Contrast</b>   | Adjusts the contrast of the screen.   |   |
|                       | <b>Sharpness</b>  | Adjusts the sharpness of the screen.  |   |
|                       | <b>Gamma</b>      | <b>Mode 1, Mode 2, Mode 3</b>   | The higher the gamma value, the darker the image becomes. Likewise, the lower the gamma value, the lighter the image becomes. |
|                       |                   | <b>Mode 4</b>   | If you do not need to adjust the gamma settings, select Mode 4.   |
|                       | <b>Color Temp</b> | <b>Custom</b>   | The user can adjust it to red, green, or blue by customization.   |
|                       |                   | <b>Warm</b>   | Sets the screen color to a reddish tone.  |
|                       |                   | <b>Medium</b>   | Sets the screen color to between a red and blue tone.   |
|                       |                   | <b>Cool</b>   | Sets the screen color to a bluish tone.   |
|                       | <b>Manual</b>     | The user can fine - tune the color temperature.   |   |
|                       | <b>R/G/B</b>      | You can customize the picture color using <b>Red</b> , <b>Green</b> , and <b>Blue</b> colors.   |   |
|                       | <b>Six Color</b>  | Meets the user requirements for colors by adjusting the hue and saturation of the six colors (Red, Green, Blue, Cyan, Magenta and Yellow) and then saving the settings.                     |   |
|                       |                   | <b>Hue</b>  | Adjusts the tone of the screen colors.  |
| <b>Saturation</b>     |                   | Adjusts the saturation of the screen colors. The lower the value, the less saturated and brighter the colors become. The higher the value, the more saturated and darker the colors become. |   |

|                       |                      |   |  |
|-----------------------|----------------------|---|--|
| <b>Picture Adjust</b> | <b>Black Level</b>   | Sets the offset level (for HDMI only).<br>• Offset: as a reference for a video signal, this is the darkest color the monitor can display. |  |
|                       |                      | <b>High</b>   | Keeps the current contrast ratio of the screen.  |
|                       |                      | <b>Low</b>  | Lowers the black levels and raises the white levels from the current contrast ratio of the screen. |
|                       | <b>DFC</b>           | <b>On</b>   | Adjusts the brightness automatically according to the screen.                                      |
|                       |                      | <b>Off</b>  | Disables the <b>DFC</b> feature.   |
|                       | <b>Picture Reset</b> | <b>No</b>   | Cancel the select.   |
|                       |                      | <b>Yes</b>  | Returns to the default settings.   |

| Menu > Input |   | Description  |   |
|--------------|---|--|---|
| Input        | <b>Input List</b>   | Selects the input mode.  |   |
|              | <b>Aspect Ratio</b>   | Adjusts the aspect ratio of the screen.  |   |
|              |   | <b>Full Wide</b>   | Displays the video in widescreen, regardless of the video signal input. |
|              |   | <b>Original</b>  | Displays video according to the aspect ratio of the video signal input. |
|              |  <b>NOTE</b>   |  |   |
|              | <ul style="list-style-type: none"> <li>The display may look the same for <b>Full Wide</b> and <b>Original</b> options at the recommended resolution. (3440 x 1440)</li> </ul> |  |   |
|              | <b>Auto Input Switch</b>  | When automatic input switch is set to <b>On</b> , display will automatically switch to new input when connected. |   |
|              |   | <b>On</b>  | Enables <b>Auto Input Switch</b> .                                      |
| <b>Off</b>   |   | Disables <b>Auto Input Switch</b> .  |   |

| Menu > General             |   | Description  |   |
|----------------------------|---|--|---|
| General                    | <b>Language</b>   | Sets the menu screen to the desired language.  |   |
|                            | <b>SMART ENERGY SAVING</b>  | <b>High</b>  | Saves energy using the high-efficiency SMART ENERGY SAVING feature.   |
|                            |   | <b>Low</b>   | Saves energy using the low-efficiency SMART ENERGY SAVING feature.  |
|                            |   | <b>Off</b>   | Disables the SMART ENERGY SAVING feature.   |
|                            |   |  <b>NOTE</b> <ul style="list-style-type: none"> <li>• The value of energy saving data may differ depending on panel and panel suppliers.</li> <li>• If you select the option of <b>SMART ENERGY SAVING</b> is <b>High</b> or <b>Low</b>, monitor luminance become lower or higher depend on source.</li> </ul>  |   |
|                            | <b>Power LED</b>  | <b>On</b>  | The power LED turns on automatically. <ul style="list-style-type: none"> <li>• On Mode: Red</li> <li>• Sleep Mode (Standby Mode) : Flashing Red</li> <li>• Off Mode: Off</li> </ul> |
|                            |   | <b>Off</b>   | The power LED turns off.  |
|                            | <b>Automatic Standby</b>  | Feature that automatically turns off the monitor when there is no movement on the screen for a period of time. You can set a timer for the auto-off function. ( <b>Off</b> , <b>4H</b> , <b>6H</b> , and <b>8H</b> )   |   |
|                            | <b>HDMI Compatibility Mode</b>  | HDMI Compatibility Mode feature can recognize the legacy equipment that does not support HDMI 2.0.   |   |
|                            |   | <b>On</b>  | Enables <b>HDMI Compatibility Mode</b> .  |
| <b>Off</b>                 |   | Disables <b>HDMI Compatibility Mode</b> .  |   |
|                            |   |  <b>NOTE</b> <ul style="list-style-type: none"> <li>• If the connected device does not support <b>HDMI Compatibility Mode</b>, the screen or sound may not work properly.</li> <li>• Some older graphics cards do not support HDMI 2.0, but you can select HDMI 2.0 resolution in the control panel of window. This may cause the screen to appear abnormally.</li> </ul> |   |
| <b>DisplayPort Version</b> | Please set the DisplayPort version to match the version of the connected external device(1.4, 1.2 and 1.1) . If you want to use the HDR, select the DP version to 1.4 . |  |   |

|         |                           |   |   |
|---------|---------------------------|---|---|
| General | Variable Backlight        | Provides global dimming effects depending on game or video content.   |   |
|         |                           | Faster  | Preferably for PC gaming experiences.                                 |
|         |                           | Fast  | Preferably for console gaming experiences.                            |
|         |                           | Normal  | Preferably for playing video content and internet or word-processing. |
|         |                           | Off   | Disables the Variable Backlight feature.                              |
|         |                           |  <b>NOTE</b> <ul style="list-style-type: none"> <li>• When these feature is enabled, a slight halo effect may be shown on dark backgrounds. This is normal and not a malfunction.</li> <li>• The function can only be used on HDR content.</li> <li>• It is recommended to turn off when you are not using the gaming function.</li> </ul> |   |
|         | Buzzer                    | This feature lets you set the sound generated from Buzzer when your monitor powers on.  |   |
|         |                           | On  | Enables your monitor's <b>Buzzer</b> .                                |
|         |                           | Off   | Disables your monitor's <b>Buzzer</b> .                               |
|         | OSD Lock                  | This feature disables the configuration and adjustment of menus.  |   |
|         |                           | On  | Enables <b>OSD Lock</b> .   |
|         |                           | Off   | Disables <b>OSD Lock</b> .  |
|         |                           |  <b>NOTE</b> <ul style="list-style-type: none"> <li>• All features are disabled except <b>Brightness, Contrast</b> in <b>Picture Adjust</b>, <b>Input</b>, <b>OSD Lock</b> and <b>Information</b> in <b>General</b>.</li> </ul>  |   |
|         | Information               | The display information will be shown the Total Power On Time, Resolution.  |   |
|         | Reset to Initial Settings | No  | Cancel the select.  |
|         |                           | Yes   | Returns to the default settings.                                      |

## TROUBLESHOOTING

| Nothing is displayed on the screen.   |  |
|---|--|
| Is the monitor's power cord plugged in?   | <ul style="list-style-type: none"> <li>• Check if the power cord is correctly plugged into the power outlet.</li> </ul>  |
| Is the power LED on?  | <ul style="list-style-type: none"> <li>• Check the power cable connection and press the power button.</li> </ul>   |
| Is the power on and the power LED displaying red?   | <ul style="list-style-type: none"> <li>• Check that the connected input is enabled (<b>Menu &gt; Input</b>).</li> </ul>  |
| Is the power LED blinking?  | <ul style="list-style-type: none"> <li>• If the monitor is in sleep mode, move the mouse, or press any key on the keyboard, to switch the display on.</li> <li>• Check if the computer is turned on.</li> </ul>  |
| Is the <b>The screen is not currently set to the recommended resolution. If you have no video or the screen flickers, see the troubleshooting guide in the product owner's manual.</b> message being displayed? | <ul style="list-style-type: none"> <li>• This occurs when signals transferred from the PC (graphics card) are out of the recommended horizontal or vertical frequency range of the monitor. Please see the Product Specification section of this manual to set the appropriate frequency.</li> </ul> |
| Is the <b>No Signal</b> message being displayed?  | <ul style="list-style-type: none"> <li>• This is displayed when the signal cable between the PC and the monitor is missing or disconnected. Check the cable and reconnect it.</li> </ul>   |
| Have you installed the display driver?  | <ul style="list-style-type: none"> <li>• Be sure to install the display driver from our web site: <a href="http://www.lg.com">http://www.lg.com</a>.</li> <li>• Make sure to check if the graphics card supports Plug and Play function.</li> </ul>  |

| Some features are disabled.                                      |  |
|--|--|
| Are some functions not available when you press the Menu button? | <ul style="list-style-type: none"> <li>• The OSD is locked. Go to <b>Menu &gt; General</b> and set <b>OSD Lock</b> to <b>Off</b>.</li> </ul> |

**The screen retains an image.**

Does image sticking occur even when the monitor is turned off?

- Displaying a still image for a prolonged time may cause damage to the screen, resulting in the retention of the image.
- To extend the lifetime of the monitor, use a screensaver.

**Screen display is unstable and shaky. / Images displayed on the monitor leave shadow trails.**

Did you select the appropriate resolution?

- If the selected resolution is HDMI 1080i 60/50 Hz (interlaced), the screen may be flickering. Change the resolution to 1080p or the recommended resolution.

**NOTE**

- Vertical Frequency: In order to display an image, the screen must be refreshed dozens of times per second, like a fluorescent lamp. The number of times the screen is refreshed per second is called vertical frequency, or refresh rate, and is represented by Hz.
- Horizontal Frequency: The time it takes to display one horizontal line is called the horizontal cycle. If 1 is divided by the horizontal interval, the result is the number of horizontal lines displayed per second. This is called horizontal frequency and is represented by kHz.
- Check if the graphics card's resolution or frequency is within the range allowed by the monitor and set it to the recommended (optimal) resolution **Control Panel > Display > Menu** in Windows. (The settings may differ depending on the operating system (OS) you use.)
- Not setting the graphics card to the recommended (optimal) resolution may result in blurred text, a dimmed screen, a truncated display area or misalignment of the display.
- The setting methods may be different depending on the computer or operating system, and some resolutions may not be available depending on the performance of the graphics card. If this is the case, contact the manufacturer of the computer or graphics card for assistance.
- Some graphics cards may not support 3440 x 1440 resolution. If the resolution cannot be displayed, contact the manufacturer of your graphics card.

| <b>The display color is abnormal.</b>                 |   |
|---|---|
| Does the display appear discolored (16 colors)?       | <ul style="list-style-type: none"> <li>• Set the color to 24 bit (true color) or higher. In Windows, go to <b>Control Panel &gt; Display &gt; Menu &gt; Color Quality</b>. (The settings may differ depending on the operating system (OS) you use.)</li> </ul> |
| Does the display color appear unstable or monochrome? | <ul style="list-style-type: none"> <li>• Check if the signal cable is connected properly. Reconnect the cable or reinsert the PC's graphics card.</li> </ul>  |
| Are there spots on the screen?                        | <ul style="list-style-type: none"> <li>• When using the monitor, pixilated spots (red, green, blue, white, or black) may appear on the screen. This is normal for an LCD screen. It is not an error, nor is it related to the monitor's performance.</li> </ul> |

| <b>No sound from the headphone port.</b>                                 |  |
|--|--|
| Are images displayed using DP (DisplayPort) or HDMI input without sound? | <ul style="list-style-type: none"> <li>• Make sure that the headphone port connections are made properly.</li> <li>• Try increasing the volume with the joystick.</li> <li>• Set the audio output of the PC to the monitor you are using. On Microsoft Windows, go to <b>Control Panel &gt; Hardware and Sound &gt; Sound &gt; set the Monitor as default device</b>. (The settings may differ depending on the operating system (OS) you use.)</li> </ul> |



# PRODUCT SPECIFICATION

|                          |                                |   |                                   |
|--------------------------|--------------------------------|---|-----------------------------------|
| LCD Screen               | Type                           | TFT (Thin Film Transistor)<br>LCD (Liquid Crystal Display) Screen   |                                   |
|                          | Color Depth                    | HDMI  | 10-bit color is supported.        |
|                          |                                | DP (DisplayPort)  | 10-bit color is supported.        |
|                          | Pixel Pitch                    | 0.2325 mm x 0.2325 mm   |                                   |
| Resolution               | Max Resolution                 | DP:3440 x 1440 @ 144Hz<br>DP:3440 x 1440 @ 160Hz (Overclock: On)<br>HDMI:3440 x 1440 @ 85Hz   |                                   |
|                          | Recommended Resolution         | DP:3440 x 1440 @ 144Hz HDMI:3440 x 1440 @ 85Hz  |                                   |
| Power Sources            | Power Rating                   | 19 V --- 5.0 A  |                                   |
|                          | Power Consumption<br>(Typical) | Operating Mode: 72 W (Typical)*<br>Sleep Mode (Standby Mode) : ≤ 0.5 W **<br>Off Mode: ≤ 0.3 W  |                                   |
|                          | AC/DC Adapter                  | ADS-110CL-19-3 190110G, manufactured by SHENZHEN HONOR ELECTRONIC<br>Or ADS-120QL-19A-3 190110E, manufactured by SHENZHEN HONOR ELECTRONIC<br>Output: 19 V --- 5.79 A |                                   |
| Environmental Conditions | Operating Conditions           | Temperature   | 0 °C to 40 °C (32 °F to 104 °F)   |
|                          |                                | Humidity  | Less than 80 %                    |
|                          | Storing Conditions             | Temperature   | -20 °C to 60 °C (-4 °F to 140 °F) |
|                          |                                | Humidity  | Less than 85 %                    |

|                            |                                       |   |
|----------------------------|---------------------------------------|---|
| Dimensions                 | Monitor Size (Width x Height x Depth) |   |
|                            | With Stand                            | 819.2 x 574.1 x 312.2 (mm)<br>32.2 x 22.6 x 12.2 (inches) |
|                            | Without Stand                         | 819.2 x 361.6 x 104.4 (mm)<br>32.2 x 14.2 x 4.1(inches)   |
| Weight (Without Packaging) | With Stand                            | 7.6 kg (16.7 lbs)   |
|                            | Without Stand                         | 5.5 kg (12.1 lbs)   |

The specifications are subject to change without notice.

The power consumption level can be different by operating condition and monitor setting.

\* The On mode power consumption is measured with LGE test standard (Full White pattern , Maximum resolution).

\*\* The monitor goes to the Sleep Mode in a couple of minutes(Max 5 minutes).

## Factory Support Mode

(Preset Mode, HDMI/ DisplayPort PC)

| Preset Mode | Horizontal Frequency (kHz) | Vertical Frequency (Hz) | Polarity (H/V) | Remarks                      |
|-------------|----------------------------|-------------------------|----------------|------------------------------|
| 640 x 480   | 31.469                     | 59.94                   | -/-            |                              |
| 800 x 600   | 37.879                     | 60.317                  | +/+            |                              |
| 1024 x 768  | 48.363                     | 60.0                    | -/-            |                              |
| 1152 x 864  | 54.347                     | 60.05                   | +/+            |                              |
| 1280 x 720  | 45                         | 60                      | +/+            |                              |
| 1280 x 800  | 49.702                     | 59.81                   | -/+            |                              |
| 1280 x 1024 | 63.981                     | 60.02                   | +/+            |                              |
| 1280 x 1024 | 79.976                     | 75.025                  | +/+            |                              |
| 1600 x 900  | 60.00                      | 60.00                   | +/+            |                              |
| 1680 x 1050 | 65.29                      | 59.954                  | -/+            |                              |
| 1920 x 1080 | 67.50                      | 60                      | +/-            |                              |
| 1920 x 1080 | 83.894                     | 74.973                  | +/-            |                              |
| 3440 x 1440 | 43.83                      | 30.00                   | +/-            | HDMI Compatibility Mode: On  |
| 3440 x 1440 | 74.60                      | 50.00                   | +/-            | HDMI Only                    |
| 3440 x 1440 | 89.52                      | 60.00                   | +/-            | DisplayPort only             |
| 3440 x 1440 | 128.69                     | 85.00                   | +/-            | HDMI Compatibility Mode: Off |
| 3440 x 1440 | 148.99                     | 99.99                   | +/-            | DisplayPort only             |

|             |        |        |     |                  |
|-------------|--------|--------|-----|------------------|
| 3440 x 1440 | 217.32 | 143.92 | +/- | DisplayPort only |
| 3440 x 1440 | 241.6  | 160    | +/- | *                |
| 2560 x 1440 | 183    | 120    | +/- | HDMI Only        |
| 2560 x 1440 | 88.79  | 60     | +/- | HDMI Only        |

\* DisplayPort only, **Adaptive-Sync**: On, **Overclock**: On

If you use an input timing that is outside the supported frequency, you may experience poor response speed or image quality.

## HDMI Timing (Video)

| Factory support mode<br>(Preset Mode) | Horizontal Frequency (kHz) | Vertical Frequency<br>(Hz) | Remarks |
|---------------------------------------|----------------------------|----------------------------|---------|
| 480p                                  | 31.5                       | 60                         |         |
| 720p                                  | 45                         | 60                         |         |
| 1080p                                 | 67.5                       | 60                         |         |
| 2160p                                 | 135                        | 60                         |         |



**Supplier's Declaration of Conformity**

|                   |  |
|-------------------|--|
| Trade Name        | LG   |
| Responsible Party | LG Electronics USA, Inc.   |
| Address           | 111 Sylvan Avenue, North Building,<br>Englewood Cliffs, NJ 07632 |
| E-mail            | lg.environmental@lge.com   |

The model and serial number of the product are located on the back and on one side of the product.

Record them below in case you ever need service.

**Model** \_\_\_\_\_

**Serial No.** \_\_\_\_\_

To obtain the source code under GPL, LGPL, MPL, and other open source licenses, that is contained in this product, please visit <http://opensource.lge.com>. In addition to the source code, all referred license terms, warranty disclaimers and copyright notices are available for download. LG Electronics will also provide open source code to you on CD-ROM for a charge covering the cost of performing such distribution (such as the cost of media, shipping, and handling) upon email request to [opensource@lge.com](mailto:opensource@lge.com). This offer is valid for three (3) years from the date on which you purchased the product.