

USER MANUAL

ProLite

LCD Monitor

ENGLISH

ProLite XB2483HSU
ProLite X2483HSU

Thank you very much for choosing the iiyama LCD monitor.

We recommend that you take a few minutes to read this comprehensive manual carefully before installing and switching on the monitor. Please keep this manual in a safe place for your future reference.



Dear user, we congratulate you on the purchase of your iiyama LCD.

For details on warranty and locally used pixel policies that apply directly after installation of your product please check the iiyama website.

To report a fault, please contact your local support centre found at <https://iiyama.com>

Things to check before you call the iiyama information line

- | if the power cable is connected securely and turned on?
- | if the display has been turned on?
- | if the signal cable is connected securely and the correct input selected?
- | if the computer has been restarted with the display connected?
- | if the graphics card is correctly installed with the latest drivers possible?
- | if the correct native resolution has been selected via 'Display Properties'?
- | If the R/G/B signal configuration is correct?
- | if the displays On Screen Menu is shown?
- | if the correct brightness and contrast settings have been set?
- | if given display tolerances and compatibility have been considered?
- | if via the On Screen Menu you have performed a Factory Reset/Recall?

Before reporting the screen defect, please prepare the following information/evidence:

- | model number *
- | purchase receipt and serial number *
- | name and address for collection
- | telephone/fax number, for availability during the day
- | convenient collection date (date, time)
- | short description of the defect

Important Note:

If there is no fault found in the collected equipment after inspection, the transferring party shall incur charges for transport and administration.

If you have checked all of the above and there is still no picture, call our information line for assistance in your country.

* see the identification plate on the back of the case.

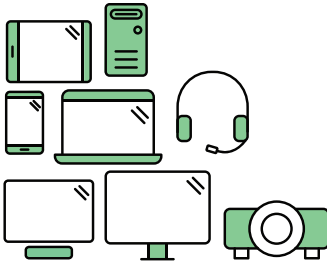

Say hello to a more sustainable product

IT products are associated with a wide range of sustainability risks throughout their life cycle. Human rights violations are common in the factories. Harmful substances are used both in products and their manufacture. Products can often have a short lifespan because of poor ergonomics, low quality and when they are not able to be repaired or upgraded.

This product is a better choice. It meets all the criteria in TCO Certified, the world's most comprehensive sustainability certification for IT products. Thank you for making a responsible product choice, that help drive progress towards a more sustainable future!

Criteria in TCO Certified have a life-cycle perspective and balance environmental and social responsibility. Conformity is verified by independent and approved verifiers that specialize in IT products, social responsibility or other sustainability issues. Verification is done both before and after the certificate is issued, covering the entire validity period. The process also includes ensuring that corrective actions are implemented in all cases of factory non-conformities. And last but not least, to make sure that the certification and independent verification is accurate, both TCO Certified and the verifiers are reviewed regularly.

Want to know more?

Read information about TCO Certified, full criteria documents, news and updates at [tcocertified.com](https://www.tcocertified.com). On the website you'll also find our Product Finder, which presents a complete, searchable listing of certified products.

CE MARKING DECLARATION OF CONFORMITY

This LCD monitor complies with the requirements of the EC/EU Directive 2014/30/EU "EMC Directive", 2014/35/EU "Low Voltage Directive", 2009/125/EC "ErP Directive" and 2011/65/EU "RoHS Directive".

The electro-magnetic susceptibility has been chosen at a level that gives correct operation in residential areas, business and light industrial premises and small-scale enterprises, inside as well as outside of the buildings. All places of operation are characterised by their connection to the public low voltage power supply system.

IYAMA CORPORATION: Wijkermeerstraat 8, 2131 HA Hoofddorp, The Netherlands

Model No. : PL2483H



We recommend recycling of used product. Please contact your dealer or iiyama service center. Recycle information is obtained via the Internet, using the address: <https://iiyama.com>

You can access the Web page of different countries from there.

- We reserve the right to change specifications without notice.
- All trademarks used in this user manual are the property of their respective owners.
- As an ENERGY STAR® Partner, iiyama has determined that this product meets the ENERGY STAR® guidelines for energy efficiency.
- This product qualifies for ENERGY STAR® in the "factory default" setting and this is the setting in which power saving will be achieved. Changing the factory default picture settings or enabling other features will increase power consumption that could exceed the limits necessary to qualify for ENERGY STAR® rating.
- The terms HDMI and HDMI High-Definition Multimedia Interface, and the HDMI Logo are trademarks or registered trademarks of HDMI Licensing Administrator, Inc. in the United States and other countries.
- Eprel registration number XB2483HSU-B5 : 1338437 X2483HSU-B5 : 1338326

TABLE OF CONTENTS

FOR YOUR SAFETY.....	1
SAFETY PRECAUTIONS.....	1
SPECIAL NOTES ON LCD MONITORS	3
CUSTOMER SERVICE	3
CLEANING	3
BEFORE YOU OPERATE THE MONITOR.....	4
FEATURES.....	4
CHECKING THE CONTENTS OF THE PACKAGE	4
INSTALLATION	5
FITTING AND REMOVAL OF STAND : ProLite XB2483HSU	7
FITTING AND REMOVAL OF STAND : ProLite X2483HSU	8
CONTROLS AND CONNECTORS : ProLite XB2483HSU	9
CONTROLS AND CONNECTORS : ProLite X2483HSU.....	10
CONNECTING YOUR MONITOR : ProLite XB2483HSU	11
CONNECTING YOUR MONITOR : ProLite X2483HSU.....	12
DISCONNECTING YOUR MONITOR.....	13
COMPUTER SETTING	13
ADJUSTING THE HEIGHT AND THE VIEWING ANGLE :	
ProLite XB2483HSU.....	13
ADJUSTING THE VIEWING ANGLE : ProLite X2483HSU	14
OPERATING THE MONITOR.....	15
ADJUSTMENT MENU CONTENTS.....	16
STANDBY FEATURE	24
TROUBLE SHOOTING	25
RECYCLING INFORMATION.....	26
APPENDIX	27
SPECIFICATIONS : ProLite XB2483HSU-B5	27
SPECIFICATIONS : ProLite X2483HSU-B5.....	28
DIMENSIONS : ProLite XB2483HSU	29
DIMENSIONS : ProLite X2483HSU	29
COMPLIANT TIMING	30

FOR YOUR SAFETY

SAFETY PRECAUTIONS

WARNING

STOP OPERATING THE MONITOR WHEN YOU SENSE TROUBLE

If you notice any abnormal phenomena such as smoke, strange sounds or fumes, unplug the monitor and contact your dealer or iiyama service center immediately. Further use may be dangerous and can cause fire or electric shock.

NEVER REMOVE THE CABINET

High voltage circuits are inside the monitor. Removing the cabinet may expose you to the danger of fire or electric shock.

DO NOT PUT ANY OBJECT INTO THE MONITOR

Do not put any solid objects or liquids such as water into the monitor. In case of an accident, unplug your monitor immediately and contact your dealer or iiyama service center. Using the monitor with any object inside may cause fire, electric shock or damage.

INSTALL THE MONITOR ON A FLAT, STABLE SURFACE

The monitor may cause an injury if it falls or is dropped.

DO NOT USE THE MONITOR NEAR WATER

Do not use where water may be splashed or spilt onto the monitor as it may cause fire or electric shock.

OPERATE UNDER THE SPECIFIED POWER SUPPLY

Be sure to operate the monitor only with the specified power supply. Use of an incorrect voltage will cause malfunction and may cause fire or electric shock.

PROTECT THE CABLES

Do not pull or bend the power cable and signal cable. Do not place the monitor or any other heavy objects on the cables. If damaged, the cables may cause fire or electric shock.

ADVERSE WEATHER CONDITIONS

It is advisable not to operate the monitor during a heavy thunder storm as the continual breaks in power may cause malfunction. It is also advised not to touch the plug in these circumstances as it may cause electric shock.

CAUTION

INSTALLATION LOCATION

Do not install the monitor where sudden temperature changes may occur, or in humid, dusty or smoky areas as it may cause fire, electric shock or damage. You should also avoid areas where the sun shines directly on the monitor.

DO NOT PLACE THE MONITOR IN A HAZARDOUS POSITION

The monitor may topple and cause injury if not suitably located. Please also ensure that you do not place any heavy objects on the monitor, and that all cables are routed such that children may not pull the cables and possibly cause injury.

MAINTAIN GOOD VENTILATION

Ventilation slots are provided to keep the monitor from overheating. Covering the slots may cause fire. To allow adequate air circulation, place the monitor at least 10cm (or 4 inches) from any walls. When removing the tilt stand, the ventilation slots on the back side of the monitor can be blocked. This may overheat the monitor and may cause fire or damage. Make sure to allow enough ventilation when removing the tilt stand. Operating the monitor on its back, side, upside down or on a carpet or any other soft material may also cause damage.

DISCONNECT THE CABLES WHEN YOU MOVE THE MONITOR

When you move the monitor, turn off the power switch, unplug the monitor and be sure the signal cable is disconnected. If you do not disconnect them, it may cause fire or electric shock.

UNPLUG THE MONITOR

If the monitor is not in use for a long period of time it is recommended that it is left unplugged to avoid accidents.

HOLD THE PLUG WHEN DISCONNECTING

To disconnect the power cable or signal cable, always pull it by the plug. Never pull on the cable itself as this may cause fire or electric shock.

DO NOT TOUCH THE PLUG WITH WET HANDS

Pulling or inserting the plug with wet hands may cause electric shock.

WHEN YOU INSTALL THE MONITOR ON YOUR COMPUTER

Be sure the computer is strong enough to hold the weight of the monitor, otherwise, you may damage your computer.

CAREFUL! PROTECT YOUR HANDS AND FINGERS

- Be careful not to hurt your fingers or hands when you change the height or the angle.
- Injury can occur if care is not taken to avoid finger contact with the displays base when adjusting the height. (Just for height adjustable model.)

REMARK FOR 24/7 USAGE

This product is not specifically designed for 24/7 usage in all environments.

OTHERS

ERGONOMIC RECOMMENDATIONS

To eliminate eye fatigue, do not operate the monitor against a bright background or in a dark room. For optimal viewing comfort, the monitor should be just below eye level and 40-60 cm (16-24 inches) away from your eyes. When using the monitor over a prolonged time, a ten minute break every hour is recommended as looking at the screen continuously can cause eye strain.

SPECIAL NOTES ON LCD MONITORS

The following symptoms are normal with LCD monitors and do not indicate a problem.

NOTE

- When you first turn on the LCD monitor, the picture may not fit in the display area because of the type of computer that is used. In this case, adjust the picture position to the correct position.
- You may find slightly uneven brightness on the screen depending on the desktop pattern you use.
- Due to the nature of the LCD screen, an afterimage of the previous screen may remain after switching the image, when the same image is displayed for hours. In this case, the screen can be recovered slowly by changing the image or turning off the Power Switch for some hours.

CUSTOMER SERVICE

NOTE

- If you have to return your unit for service and the original packaging has been discarded, please contact your dealer or iiyama service center for advice or replacement packaging.

CLEANING

WARNING

- If you drop any materials or liquids such as water into the monitor when cleaning, unplug the power cable immediately and contact your dealer or iiyama service center.

CAUTION

- For safety reasons, turn off the power switch and unplug the monitor before you clean it.

NOTE

- To protect the LCD panel, do not scratch or rub the screen with a hard object.
- Never use any of the following strong solvents. These will damage the cabinet and the LCD screen.

Thinner	Spray-type cleaner
Benzine	Wax
Abrasive cleaner	Acid or Alkaline solvent

- Touching the cabinet with any product made from rubber or plastic for a long time may cause degeneration or loss of paint on the cabinet.

CABINET

Stains can be removed with a cloth lightly moistened with a mild detergent solvent. Then wipe the cabinet with a soft dry cloth.

LCD SCREEN

Periodic cleaning with a soft dry cloth is recommended.

Don't use tissue paper etc. because these will damage the LCD screen.

BEFORE YOU OPERATE THE MONITOR

FEATURES

- ◆ Supports Resolutions up to 1920 × 1080
- ◆ High Contrast 3000:1 (Typical), Adv. Contrast Function Available / Brightness 250cd/m² (Typical) / Response Time : 4ms (Gray to Gray)
- ◆ Blue Light Reducer
- ◆ Flicker-Free
- ◆ Digital Character Smoothing
- ◆ Automatic Set-up
- ◆ 2 × 2W Stereo Speakers
- ◆ ENERGY STAR® Compliant
- ◆ Standby Feature
- ◆ VESA Mounting Standard (100mm×100mm) Compliant
- ◆ Keyhole for Security Lock

CHECKING THE CONTENTS OF THE PACKAGE

The following accessories are included in your package. Check to see if they are enclosed with the monitor. If anything is missing or damaged, please contact your local iiyama dealer or regional iiyama office.

- | | | |
|-----------------------------|-----------------------------------------|----------------------------|
| ■ Power Cable* ¹ | ■ HDMI Cable | ■ USB Cable |
| ■ Stand-Neck | ■ Stand-Base with a screw* ² | ■ Stand-Base* ³ |
| ■ Screwdriver* ² | ■ Safety Guide | ■ Quick Start Guide |

CAUTION

*¹ The rating of the Power Cable enclosed in 120V area is 10A/125V. If you are using a power supply higher than this rating, then a power cable with a rating of 10A/250V must be used. However, all guarantees and warranties are void for any problems or damage caused by a power cable not supplied by iiyama. An approved power cord greater or equal to H05VVF, 3G, 0.75mm² must be used.

*² Accessory for **ProLite XB2483HSU**

*³ Accessory for **ProLite X2483HSU**

INSTALLATION

- CAUTION** ■ Before installation, make sure the wall, ceiling or desktop arm is strong enough to hold the necessary weight of the display and the mount.

< WALL MOUNTING >

- CAUTION** ■ When you use with the wall mounting, in consideration of thickness of the mounting stage, tighten the M4 Screws (4 pcs) which "L" length is 7mm to fasten the monitor. Using the screw longer than this may cause electric shock or damage because it may contact with the electrical parts inside the monitor.

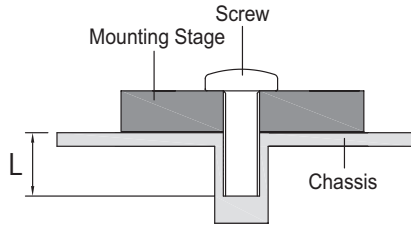

< ROTATING THE MONITOR >

• ProLite XB2483HSU

The monitor is designed to be compatible with both landscape and portrait modes. Video card for portrait display will be required for rotating the image on the screen.

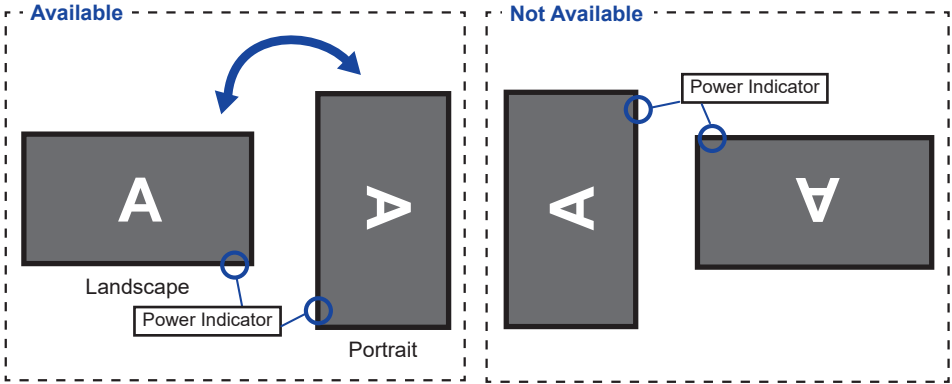

With Stand:

NOTE

- Adjust the monitor's height before panel rotation.
- Attempting to rotate the panel forcibly without adjusting the stand height may cause damage to the panel or the stand.

• ProLite X2483HSU

The monitor is designed to be compatible only with the landscape mode.

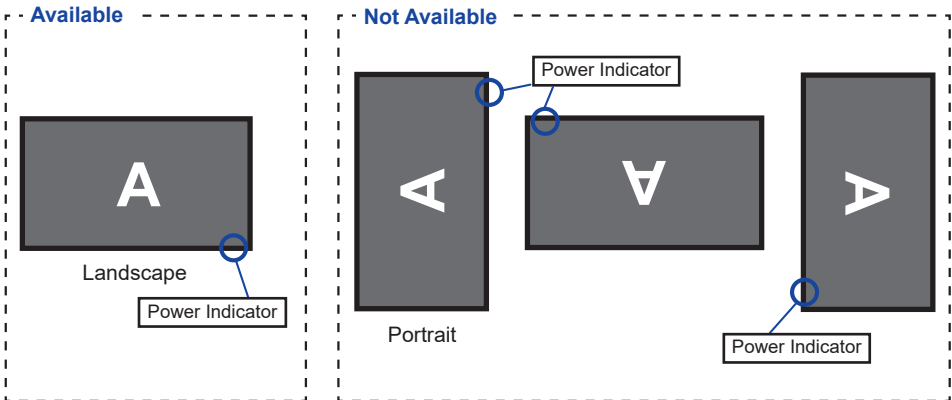

FITTING AND REMOVAL OF STAND : ProLite XB2483HSU

CAUTION

- Put the monitor on a stable surface. The monitor may cause injury or damage if it falls or is dropped.
- Do not give a strong impact to the monitor. It may cause damage.
- Unplug the monitor before removal or installation to avoid an electric shock or a damage.

<Installation>

- ① Put a piece of soft cloth on the table beforehand to prevent the monitor from being scratched. Lay the monitor flat on a table with front face down.
- ② Install the Stand-Neck to the monitor and then tighten the 'thumb screw' with the provided screwdriver to secure them.

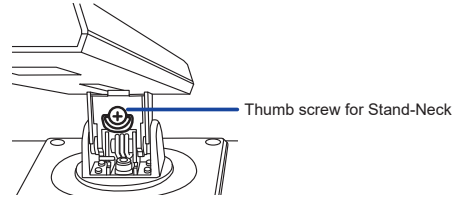
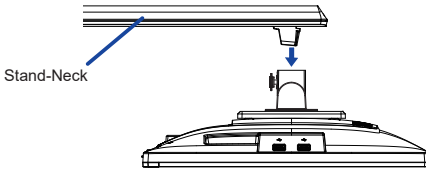

- ③ Install the Stand-Base to the Stand-Neck and then tighten the 'thumb screw' to secure them.

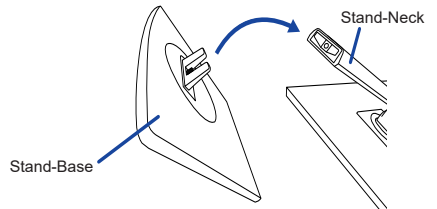
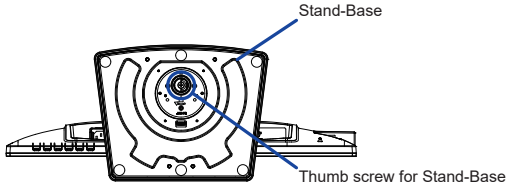

<Removal>

- ① Put a piece of soft cloth on the table beforehand to prevent the monitor from being scratched. Lay the monitor flat on a table with front face down.
- ② Loosen the 'thumb screw' to remove the Stand-Base from the Stand-Neck.
- ③ Loosen the 'thumb screw' with the provided screwdriver to remove the Stand-Neck from the monitor.

FITTING AND REMOVAL OF STAND : ProLite X2483HSU

CAUTION

- Put the monitor on a stable surface. The monitor may cause injury or damage if it falls or is dropped.
- Do not give a strong impact to the monitor. It may cause damage.
- Unplug the monitor before removal or installation to avoid an electric shock or a damage.

<Installation>

- ① Put a piece of soft cloth on the table beforehand to prevent the monitor from being scratched. Lay the monitor flat on a table with front face down.
- ② Hold the monitor and install the Stand-Neck to the monitor until it clicks to secure.
- ③ Install the Stand-Base to the Stand-Neck.

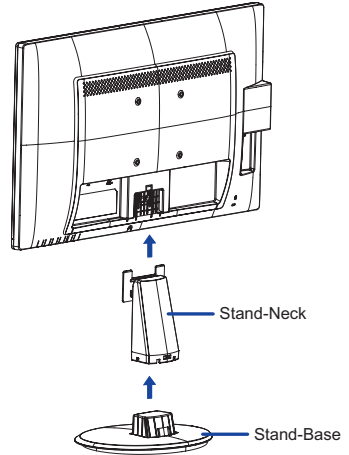

<Removal>

- ① Put a piece of soft cloth on the table beforehand to prevent the monitor from being scratched. Lay the monitor flat on a table with front face down.
- ② Keep pressing the Hooks inward to pull out the Stand-Base.
- ③ Press the Hook on the back of the monitor and remove the Stand-Neck from the monitor.

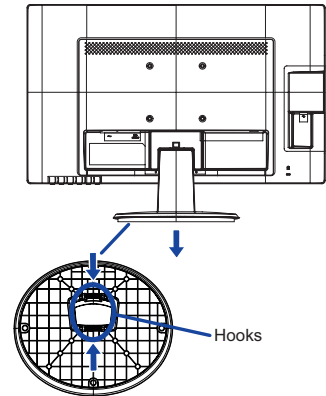
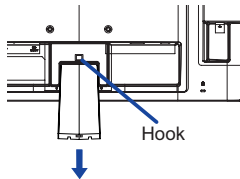

CONTROLS AND CONNECTORS : ProLite XB2483HSU

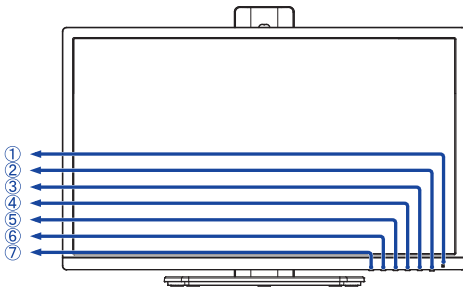

<Front>

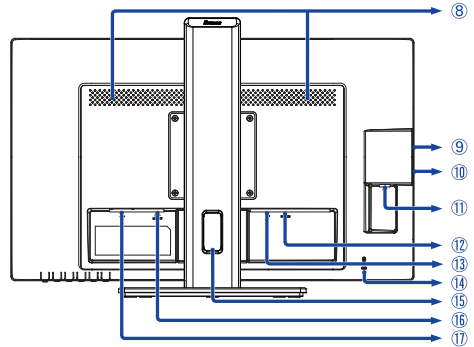

<Back>

① Power Indicator

NOTE Blue: Normal operation
Orange: Standby Mode

② Power Switch (⏻)

③ Menu / Select Button (ENTER)

④ Scroll Up / Volume Button (▶ / 🔊)

⑤ Scroll Down / ECO Mode Button (◀ / 🍃)

⑥ Exit Button (EXIT)

⑦ Input Select Button (INPUT)

⑧ Speakers

⑨ USB Downstream Connector (🔌 5V, 500mA)

⑩ USB Downstream Connector (🔌 5V, 500mA)

⑪ USB Upstream Connector (🔌)

⑫ HDMI Connector (HDMI)

⑬ DisplayPort Connector (DP)

⑭ Keyhole for Security Lock

NOTE You can fasten a security lock and cable to prevent the monitor from being removed without your permission.

⑮ Cable Hole

⑯ Headphone Connector (LINE OUT)

⑰ AC Connector (⚡ : Alternating current)

CONTROLS AND CONNECTORS : ProLite X2483HSU

ENGLISH

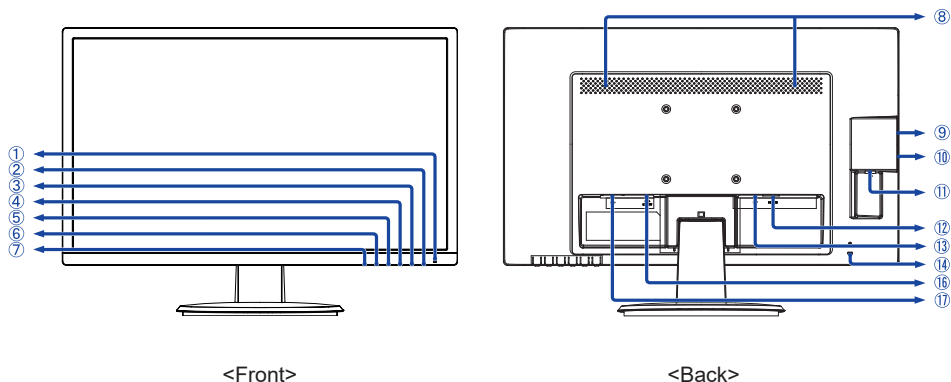

① Power Indicator

NOTE Blue: Normal operation
Orange: Standby Mode

② Power Switch (⏻)

③ Menu / Select Button (ENTER)

④ Scroll Up / Volume Button (▶ / 🔊)

⑤ Scroll Down / ECO Mode Button (◀ / 🌿)

⑥ Exit Button (EXIT)

⑦ Input Select Button (INPUT)

⑧ Speakers

⑨ USB Downstream Connector (🔌 5V, 500mA)

⑩ USB Downstream Connector (🔌 5V, 500mA)

⑪ USB Upstream Connector (🔌)

⑫ HDMI Connector (HDMI)

⑬ DisplayPort Connector (DP)

⑭ Keyhole for Security Lock

NOTE You can fasten a security lock and cable to prevent the monitor from being removed without your permission.

⑯ Headphone Connector (LINE OUT)

⑰ AC Connector (~ : Alternating current)

CONNECTING YOUR MONITOR : ProLite XB2483HSU

- ① Ensure that both the computer and the monitor are switched off.
- ② Connect the computer to the monitor with the signal cable.
- ③ Connect the computer to the monitor with the USB Cable.
- ④ Connect the Power Cable to the monitor first and then to the power source.
- ⑤ Turn on your monitor and computer.

NOTE

- Make sure that the building installation has a circuit breaker of 120/240V, 20A (maximum).
- The signal cables used for connecting the computer and monitor may vary with the type of computer used. An incorrect connection may cause serious damage to both the monitor and the computer. The cable supplied with the monitor is for a standard connector. If a special cable is required please contact your local iiyama dealer or regional iiyama office.
- The Class I pluggable equipment Type A must be connected to protective earth.
- The socket-outlet shall be installed near the equipment and shall be easily accessible.
- Excessive sound pressure from ear-/headphones can cause hearing damage/hearing loss.

[Example of Connection]

<Back>

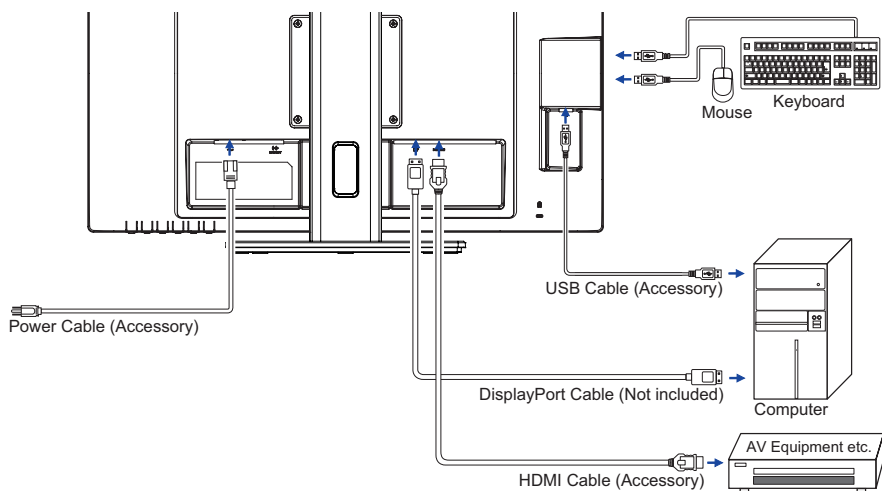

[Collect Cables]

Put the cables through the cable hole to bundle them.

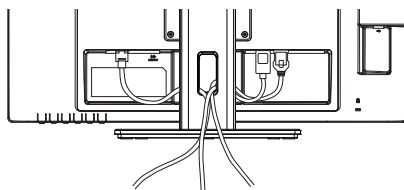

CONNECTING YOUR MONITOR : ProLite X2483HSU

- ① Ensure that both the computer and the monitor are switched off.
- ② Connect the computer to the monitor with the signal cable.
- ③ Connect the computer to the monitor with the USB Cable.
- ④ Connect the Power Cable to the monitor first and then to the power source.
- ⑤ Turn on your monitor and computer.

NOTE

- Make sure that the building installation has a circuit breaker of 120/240V, 20A (maximum).
- The signal cables used for connecting the computer and monitor may vary with the type of computer used. An incorrect connection may cause serious damage to both the monitor and the computer. The cable supplied with the monitor is for a standard connector. If a special cable is required please contact your local iiyama dealer or regional iiyama office.
- The Class I pluggable equipment Type A must be connected to protective earth.
- The socket-outlet shall be installed near the equipment and shall be easily accessible.
- Excessive sound pressure from ear-/headphones can cause hearing damage/hearing loss.

[Example of Connection]

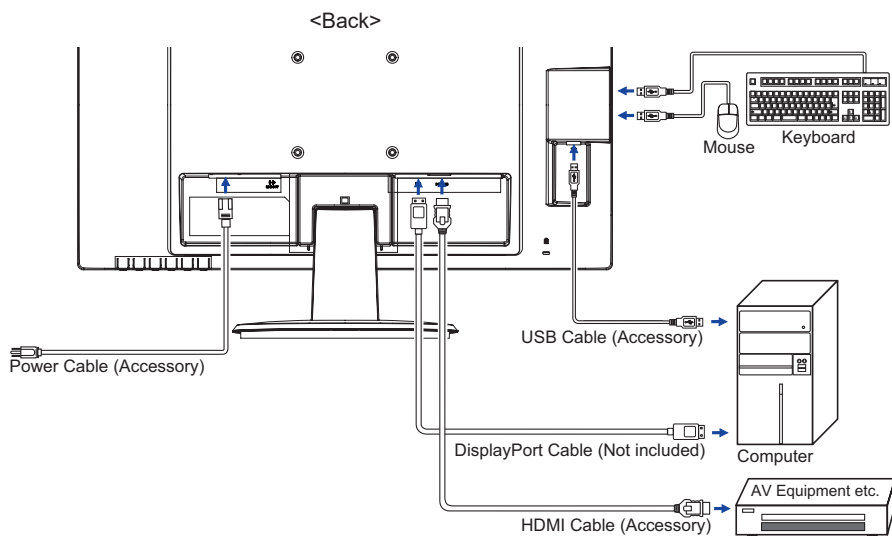

DISCONNECTING YOUR MONITOR

- ① Ensure that both the computer and the monitor are switched off.
- ② Disconnect the power source first and then the Power Cable from the monitor.
- ③ Disconnect the USB cable from the computer and the monitor.
- ④ Disconnect the signal cable from the computer and the monitor.

COMPUTER SETTING

- Signal Timing
Change to the desired signal timing listed on page 30: COMPLIANT TIMING.

ADJUSTING THE HEIGHT AND THE VIEWING ANGLE : ProLite XB2483HSU

- For optimal viewing it is recommended to position yourself directly opposite to the full face of the monitor, then adjust the monitor's height and angle to your own preference.
- Hold the panel so that the monitor does not topple when you change the monitor's height or angle.
- You are able to adjust the monitor's height up to 150mm, angle up to 45° right and left, 23° upward and 5° downward.

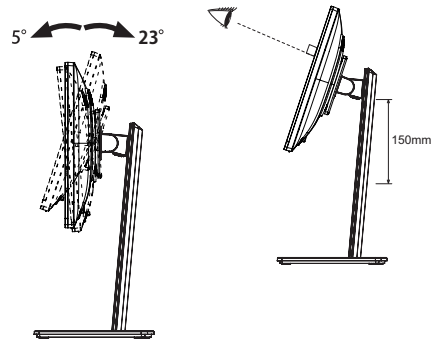

- NOTE**
- Do not touch the LCD screen when you change the height or the angle. It may cause damage or break the LCD screen.
 - Careful attention is required not to pinch your fingers or hands into the moving part of the stand when you change the height or the angle.
 - Injury can occur if care is not taken to avoid finger contact with the displays base when adjusting the height.

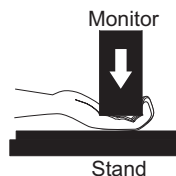
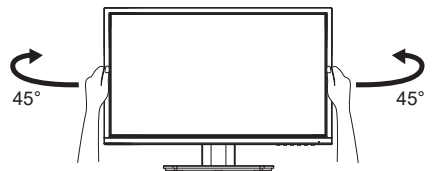

ADJUSTING THE VIEWING ANGLE : ProLite X2483HSU

- For optimal viewing it is recommended to look at the full face of the monitor.
- Hold the stand so that the monitor does not topple when you change the monitor's angle.
- You are able to adjust the monitor's angle up to 22° upward, 5° downward.
- In order to ensure a healthy and relaxed body position when using the monitor at visual display workstations, it is recommended that the adjusted tilt angle should not exceed 10°. Adjust the monitor's angle to your own preference.

NOTE

- Do not touch the LCD screen when you change the angle. It may cause damage or break the LCD screen.
- Careful attention is required not to pinch your fingers or hands into the moving part of the stand when you change the angle.

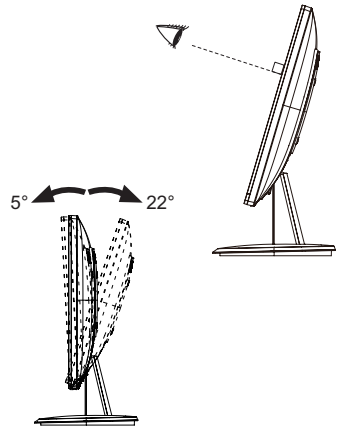

OPERATING THE MONITOR

To create the best picture, your iiyama LCD monitor has been preset at the factory with the COMPLIANT TIMING shown on page 30. You are also able to adjust the picture by following the button operation shown below.

- 1 Press the ENTER Button to start the On Screen Display feature. There are additional Menu items which can be switched by using the ◀ / ▶ Buttons.



- 2 Select the Menu item which contains the adjustment icon relating to the adjustment you want to make. Press the ENTER Button. Then, use the ◀ / ▶ Buttons to highlight the desired adjustment icon.
- 3 Press the ENTER Button again. Use the ◀ / ▶ Buttons to make the appropriate adjustment or setting.
- 4 Press the EXIT Button to leave the menu, and the settings you just made would be automatically saved.

For example, to correct for OSD vertical position, select "OSD" of Menu item and then press the ENTER Button. Then, select "OSD Vertical Position" by using the ◀ / ▶ Buttons. An adjustment page appears after you press the ENTER Button.

Then, use the ◀ / ▶ Buttons to change the OSD vertical position settings. The OSD vertical position should be changing accordingly while you are doing this.

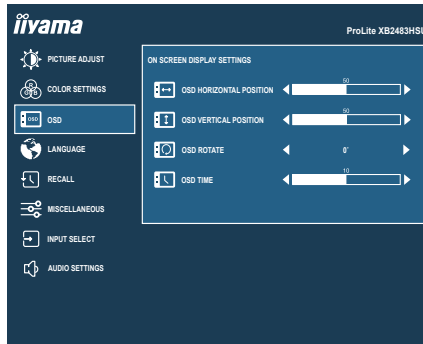

Press the EXIT Button lastly and all changes are saved in the memory.

NOTE

- When button operations are aborted during adjustment, On-Screen Display disappears when the time set for the OSD Time has passed. Also, press the EXIT button to quickly turn off the On-Screen Display.
- Any changes are automatically saved in the memory when the On Screen Display disappears. Turning off the power should be avoided while using the Menu.
- All adjustments have only one setting which applies to all signal timings.

ADJUSTMENT MENU CONTENTS

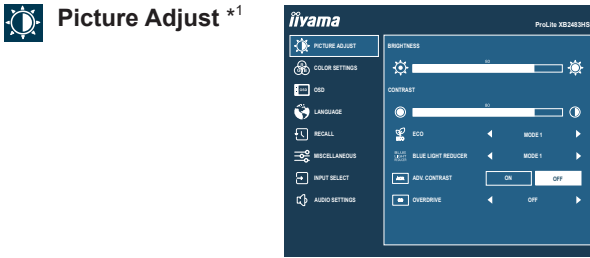

Adjustment Item	Problem / Option		Button to Press
Brightness *2,3,4	Too dark Too bright		
Contrast *3	Too dull Too intense		
ECO *3 Direct	Off	Normal	
	Mode 1	Brightness of back-light is reduced.	
	Mode 2	Brightness of back-light is reduced more than Mode1.	
	Mode 3	Brightness of back-light is reduced more than Mode2.	
Blue Light Reducer	Off	Typical	
	Mode 1	Blue light is reduced.	
	Mode 2	Blue light is reduced more than Mode1.	
	Mode 3	Blue light is reduced more than Mode2.	
Adv. Contrast *4	On	Increased Contrast Ratio	
	Off	Typical Contrast Ratio	
Overdrive	Off / 1 / 2 / 3	It will improve the gray level response time of the LCD panel. A higher level results in a faster response time.	

*1 Picture Adjust is disabled when i-Style Color is activated.

*2 Adjust the Brightness when you are using the monitor in a dark room and feel the screen is too bright.

*3 Brightness, Contrast and ECO adjustments are disabled when Adv. Contrast is activated.

*4 Brightness and Adv. Contrast adjustment are disabled when ECO is activated.

Direct



You can skip the Menu items and directly display an option setting screen by using the following button operations.

- ECO : Press the Button when the Menu is not displayed.

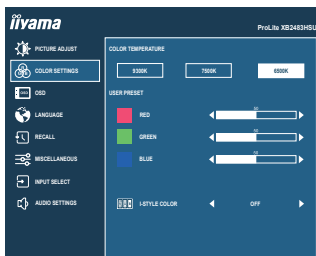

Color Settings



Adjustment Item	Problem / Option	Button to Press
Color Temperature * ¹	9300K	Cool color
	7500K	Normal color
	6500K	Warm color
User Preset * ¹	Red	Too weak 
	Green	
	Blue	Too strong 
i-Style Color * ² Direct	Off	Return to a state set by color adjustment except i-Style Color.
	Standard	For general windows environment and monitor default setting.
	Game	For PC game environment.
	Cinema	For movie and video environment.
	Scenery	For displaying outdoor scenery images
	Text	For text editing and viewing in a word processing environment.

*¹ Color Temperature and User Preset settings are disabled when i-Style Color or Blue Light Reducer is activated.







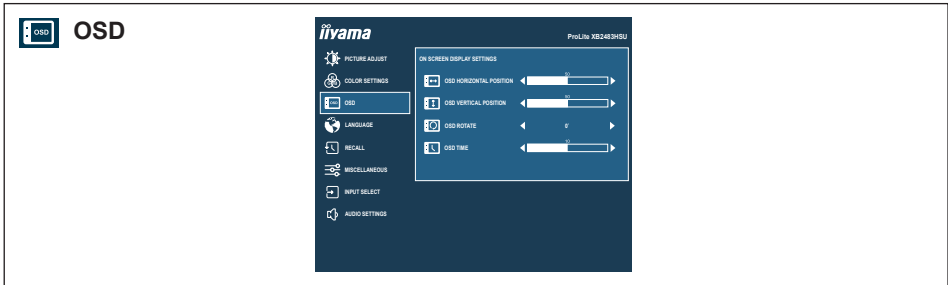

*² i-Style Color adjustment is disabled when Blue Light Reducer is activated.

Direct

You can skip the Menu items and directly display an option setting screen by using the following button operations.

- i-Style Color : Press the EXIT Button when the Menu is not displayed.



Adjustment Item	Problem / Option	Button to Press
OSD Horizontal Position	OSD is too left OSD is too right	 
OSD Vertical Position	OSD is too low OSD is too high	 
OSD Rotate	Rotate the OSD. 0° (Normal) / +90° (Rotate right)	 
OSD Time	You can set the OSD display duration time between 5 and 30 seconds.	 



Language

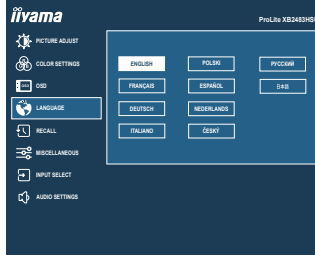

Adjustment Item	Option			
Language	English	English	Español	Spanish
	Français	French	Nederlands	Dutch
	Deutsch	German	Česky	Czech
	Italiano	Italian	Русский	Russian
	Polski	Polish	日本語	Japanese

ENGLISH



Recall

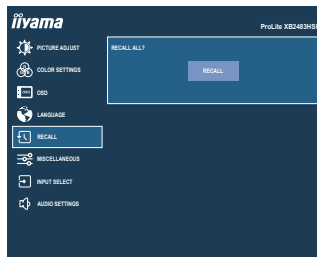



Adjustment Item	Option
Recall	Factory-preset data is restored.

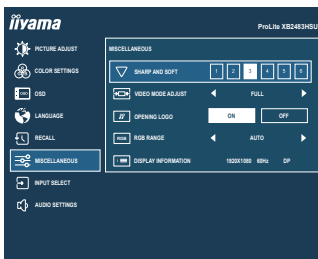

Miscellaneous



Adjustment Item	Problem / Option		Button to Press
Sharp and Soft	1 2 3 4 5 6 You can change the picture quality from 1 to 6 (sharp to soft). Press the ► Button to change the picture quality in numerical order. Press the ◀ Button to change the picture quality in reverse numerical order.		 
Video Mode Adjust	Full	Full screen display	
	Aspect *	Expansion display of Aspect	
Opening Logo	On	iiyama Logo is displayed when the monitor is turned on.	
	Off	iiyama Logo is not displayed when the monitor is turned on.	
RGB Range	Auto	Automatically select color scale signal.	
	Full	For full-range color scale signal	
	Limited	For limited color scale signal	
Display Information	Displays information regarding the current input signal coming from the graphics card in your computer. <div style="border: 1px solid black; padding: 2px; display: inline-block; margin-top: 5px;">NOTE</div> See your graphics card user guide for more information about changing the resolution and refresh.		

* Option is unavailable with 16:9 resolution.



Input Select

Direct

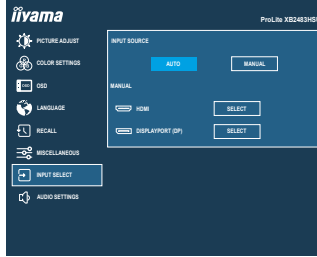

Adjustment Item	Option		
Input Source	Auto	Search for an available input source and select automatically.	
	Manual	HDMI	Select the Digital (HDMI) input.
		DisplayPort	Select the Digital (DisplayPort) input.

NOTE If "Auto" is selected, only one source available is selected automatically. Signal switching is not possible if the computer to which the signal you want to select is connected is in standby mode. Input source is fixed and it will not be detected automatically when you select HDMI or DisplayPort manually.

ENGLISH

Direct





You can skip the Menu items and directly display an option setting screen by using the following button operations.



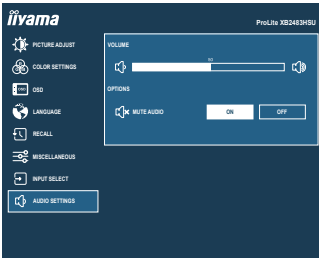

- Input Select : Press the INPUT Button when the Menu is not displayed.



Audio Settings



Adjustment Item	Problem / Option	Button to Press				
Volume Direct	Too soft Too loud	   				
Mute Audio	<table border="1" style="width: 100%; border-collapse: collapse;"> <tr> <td style="width: 20%; text-align: center;">On</td> <td>Turn off the sound temporarily.</td> </tr> <tr> <td style="text-align: center;">Off</td> <td>Return the sound volume to the previous level.</td> </tr> </table>	On	Turn off the sound temporarily.	Off	Return the sound volume to the previous level.	
On	Turn off the sound temporarily.					
Off	Return the sound volume to the previous level.					

NOTE Press the   Button to display the volume adjustment bar and switch On and Off the Mute function by pressing the   Buttons.

Direct

You can skip the Menu items and directly display an adjustment scale by using the following button operations.

- Volume : Press the  Button when the Menu is not displayed.

■ Lock Mode

<OSD Menu>

The OSD can be locked to avoid an accidental setting change.

1. Make sure the monitor is turned ON.
2. The OSD lock will be activated by pressing the front ENTER Button for about 10 seconds. If you try to access the OSD by pressing any of the buttons, a message "OSD Locked" will appear on the screen.
3. The OSD lock will be deactivated by pressing the front ENTER Button again for about 10 seconds.

<Power Switch>

The Power Switch can be locked to avoid an accidental power operation.

1. Make sure the monitor is turned ON.
2. The Power Switch lock will be activated by pressing the front ◀ Button for about 10 seconds. If you try to turn off the monitor by pressing the Power Switch, a message "Power Button Locked" will appear on the screen.
3. The Power Switch lock will be deactivated by pressing the front ◀ Button again for about 10 seconds.

STANDBY FEATURE

This product features the standby function. When activated, it automatically reduces unnecessary power consumption of the monitor when your computer is not in use.

There is a standby step the monitor takes as described below. The standby function, including any timer settings is configured by the operating system. Check your operating system manual for information on how this can be configured.

■ Standby Mode

When the video signal from the computer is off, the monitor enters into Standby Mode which reduces the power consumption to less than 0.5W*. The screen becomes dark, and the power indicator turns to orange. From Standby Mode, the image reappears in several seconds when either the keyboard or the mouse are touched again.

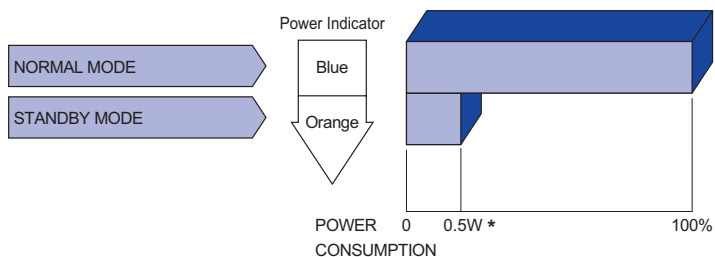

* When the USB devices are not connected.

TROUBLE SHOOTING

If the monitor fails to operate correctly, please follow the steps below for a possible solution.

1. Perform the adjustments described in OPERATING THE MONITOR, depending on the problem you have. If the monitor does not get a picture, skip to 2.
2. Consult the following items if you cannot find an appropriate adjustment item in OPERATING THE MONITOR or if the problem persists.
3. If you are experiencing a problem which is not described below or you cannot correct the problem, discontinue using the monitor and contact your dealer or iiyama service center for further assistance.

Problem	Check
① The picture does not appear. (Power indicator does not light up.) (Power indicator is blue.) (Power indicator is orange.)	<input type="checkbox"/> The Power Cable is firmly seated in the socket. <input type="checkbox"/> The Power Switch is turned ON. <input type="checkbox"/> The AC socket is live. Please check with another piece of equipment. <input type="checkbox"/> If the blank screen saver is in active mode, touch the keyboard or the mouse. <input type="checkbox"/> Increase the Contrast and/or Brightness. <input type="checkbox"/> The computer is ON. <input type="checkbox"/> The Signal Cable is properly connected. <input type="checkbox"/> The signal timing of the computer is within the specification of the monitor. <input type="checkbox"/> If the monitor is in standby mode, touch the keyboard or the mouse. <input type="checkbox"/> The computer is ON. <input type="checkbox"/> The Signal Cable is properly connected. <input type="checkbox"/> The signal timing of the computer is within the specification of the monitor.
② The screen is not synchronized.	<input type="checkbox"/> The Signal Cable is properly connected. <input type="checkbox"/> The signal timing of the computer is within the specification of the monitor.
③ The screen position is not in the center.	<input type="checkbox"/> The signal timing of the computer is within the specification of the monitor.
④ The screen is too bright or too dark.	<input type="checkbox"/> The video output level of the computer is within the specification of the monitor.

Problem

Check

- | | |
|---------------------------------------|--------------------------------------------------------------------------------------------------------------------|
| ⑤ The screen is shaking. | <input type="checkbox"/> The power voltage is within the specification of the monitor. |
| | <input type="checkbox"/> The signal timing of the computer is within the specification of the monitor. |
| ⑥ No sound. | <input type="checkbox"/> The audio equipment (computer etc.) is ON. |
| | <input type="checkbox"/> The Volume is turned up. |
| | <input type="checkbox"/> The Mute is OFF. |
| | <input type="checkbox"/> The audio output level of the audio equipment is within the specification of the monitor. |
| ⑦ The sound is too loud or too quiet. | <input type="checkbox"/> The audio output level of the audio equipment is within the specification of the monitor. |

RECYCLING INFORMATION

For better environment protection please don't dispose your monitor.
Please visit our web site: <https://iiyama.com> for monitor recycling.

APPENDIX

Design and specifications are subject to change without prior notice.

SPECIFICATIONS : ProLite XB2483HSU-B5

Size Category	24"	
LCD Panel	Panel technology	AMVA
	Size	Diagonal: 23.8" (60.5cm)
	Pixel pitch	0.275mm H × 0.275mm V
	Brightness	250cd/m ² (Typical), 200cd/m ² (Default / Energy Saving)
	Contrast ratio	3000 : 1 (Typical), Adv. Contrast Function Available
	Viewable angle	Right / Left : 89 ° each, Up / Down : 89 ° each (Typical)
	Response time	4ms (Gray to Gray)
Display Colors	Approx.16.7Million	
Sync Frequency	Horizontal: 30.0-80.0kHz, Vertical: 55-75Hz	
Native Resolution	1920 × 1080, 2.1 MegaPixels	
Support max. resolution	HDMI: 1920 × 1080 75Hz DisplayPort: 1920 × 1080 75Hz	
Input Connector	HDMI, DisplayPort	
Input Video Signal	HDMI, DisplayPort	
USB Standard	USB2.0 (DC5V, 500mA)	
Number of USB Ports	1 Upstream : Series B	
Connector shape	2 Downstream : Series A	
Headphone Connector	ø 3.5mm mini jack (Stereo)	
Speakers	2W × 2 (Stereo speakers)	
Maximum Screen Size	527.0mm W × 296.5mm H / 20.7" W × 11.7" H	
Power Source	100-240VAC, 50/60Hz, 1.5A	
Power Consumption*	18W typical, Standby mode: 0.5W maximum, Off mode: 0.3W maximum	
Dimensions / Net Weight	552.5 × 349.5 - 499.5 × 209.5mm / 21.8 × 13.8 - 19.7 × 8.2" (W×H×D) 5.5kg / 12.1lbs	
Angle	Tilt: Upward: 23° Downward: 5° Swivel: Left/Right: 45° each Rotation: Clockwise: 90°	
Environmental Considerations	Operating: Temperature 5 to 35°C / 41 to 95°F Humidity 10 to 80% (No condensation) Storage: Temperature -20 to 60°C / -4 to 140°F Humidity 10 to 90% (No condensation)	
Approvals	TCO Certified, CE, UKCA, TÜV-GS, VCCI, EAC, ENERGY STAR®	

NOTE * When the USB devices are not connected.

SPECIFICATIONS : ProLite X2483HSU-B5

ENGLISH

Size Category	24"	
LCD Panel	Panel technology	AMVA
	Size	Diagonal: 23.8" (60.5cm)
	Pixel pitch	0.275mm H × 0.275mm V
	Brightness	250cd/m ² (Typical), 200cd/m ² (Default / Energy Saving)
	Contrast ratio	3000 : 1 (Typical), Adv. Contrast Function Available
	Viewable angle	Right / Left : 89 ° each, Up / Down : 89 ° each (Typical)
	Response time	4ms (Gray to Gray)
Display Colors	Approx.16.7Million	
Sync Frequency	Horizontal: 30.0-80.0kHz, Vertical: 55-75Hz	
Native Resolution	1920 × 1080, 2.1 MegaPixels	
Support max. resolution	HDMI: 1920 × 1080 75Hz DisplayPort: 1920 × 1080 75Hz	
Input Connector	HDMI, DisplayPort	
Input Video Signal	HDMI, DisplayPort	
USB Standard	USB2.0 (DC5V, 500mA)	
Number of USB Ports	1 Upstream : Series B	
Connector shape	2 Downstream : Series A	
Headphone Connector	ø 3.5mm mini jack (Stereo)	
Speakers	2W × 2 (Stereo speakers)	
Maximum Screen Size	527.0mm W × 296.5mm H / 20.7" W × 11.7" H	
Power Source	100-240VAC, 50/60Hz, 1.5A	
Power Consumption*	18W typical, Standby mode: 0.5W maximum, Off mode: 0.3W maximum	
Dimensions / Net Weight	552.5 × 406.5 × 232.0mm / 21.8 × 16.0 × 9.1" (W×H×D) 3.9kg / 8.6lbs	
Tilt Angle	Upward: 22° Downward: 5°	
Environmental Considerations	Operating: Temperature 5 to 35°C / 41 to 95°F Humidity 10 to 80% (No condensation) Storage: Temperature -20 to 60°C / -4 to 140°F Humidity 10 to 90% (No condensation)	
Approvals	TCO Certified, CE, UKCA, TÜV-GS, VCCI, EAC, ENERGY STAR®	

NOTE * When the USB devices are not connected.

DIMENSIONS : ProLite XB2483HSU

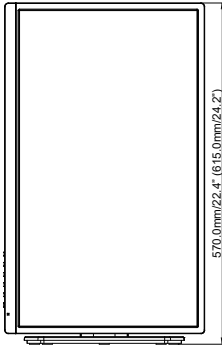
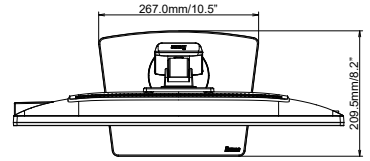
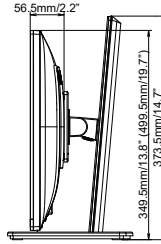
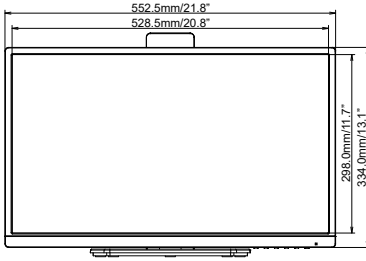

() : Maximum adjustment range

DIMENSIONS : ProLite X2483HSU

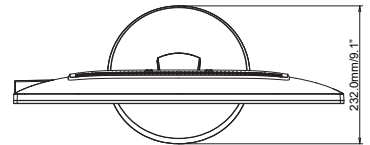
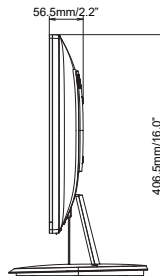
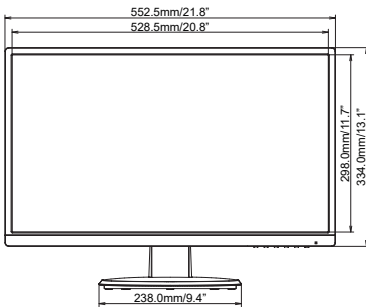

COMPLIANT TIMING

Video Mode	Horizontal Frequency	Vertical Frequency	Dot Clock
640 × 480	31.469kHz	59.940Hz	25.175MHz
800 × 600	37.879kHz	60.317Hz	40.000MHz
1024 × 768	48.363kHz	60.004Hz	65.000MHz
1280 × 1024	63.981kHz	60.020Hz	108.000MHz
1440 × 900	55.935kHz	59.887Hz	106.500MHz
1680 × 1050	65.290kHz	60.000Hz	146.250MHz
1920 × 1080	66.590kHz	59.930Hz	138.500MHz
	83.890kHz	74.970Hz	174.500MHz