

# PHILIPS

## Momentum

275M2



[www.philips.com/welcome](http://www.philips.com/welcome)

EN	User manual	1
	Customer care and warranty	24
	Troubleshooting & FAQs	28

# Table of Contents

1. Important .....	1
1.1 Safety precautions and maintenance .....	1
1.2 Notational Descriptions .....	3
1.3 Disposal of product and packing material.....	4
2. Setting up the monitor.....	5
2.1 Installation .....	5
2.2 Operating the monitor.....	6
2.3 Remove the Base Assembly for VESA Mounting.....	10
2.4 MultiView(275M2CRP) .....	11
3. Image Optimization .....	13
3.1 SmartImage .....	13
3.2 SmartContrast.....	15
4. AMD FreeSync Premium.....	16
5. HDR .....	17
6. Technical Specifications .....	18
6.1 Resolution & Preset Modes .....	21
7. Power Management .....	22
8. Customer care and warranty ..	23
8.1 Philips' Flat Panel Monitors Pixel Defect Policy.....	23
8.2 Customer Care & Warranty .....	26
9. Troubleshooting & FAQs.....	27
9.1 Troubleshooting.....	27
9.2 General FAQs.....	28

# 1. Important

This electronic user's guide is intended for anyone who uses the Philips monitor. Take time to read this user's manual before you use your monitor. It contains important information and notes regarding the operation of your monitor.

The Philips guarantee applies provided the product is handled properly for its intended use, in accordance with its operating instructions and upon presentation of the original invoice or cash receipt, indicating the date of purchase, dealer's name and model and production number of the product.

## 1.1 Safety precautions and maintenance

### Warnings

Use of controls, adjustments or procedures other than those specified in this documentation may result in exposure to shock, electrical hazards and/or mechanical hazards.

Read and follow these instructions when connecting and using your computer monitor.

Excessive sound pressure from earphones and headphones can cause hearing loss. Adjustment of the equalizer to maximum increases the earphones and headphones output voltage and therefore the sound pressure level.

### Operation

- Please Keep the monitor out of direct sunlight, very strong bright lights and away from any other heat source. Lengthy exposure to this type of environment may result in discoloration and damage to the monitor.
- Keep the display away from oil. Oil may damage the plastic cover of the display and void the warranty.
- Remove any object that could fall into ventilation holes or prevent proper cooling of the monitor's electronics.
- Do not block the ventilation holes on the cabinet.
- When positioning the monitor, make sure the power plug and outlet are easily accessible.
- If turning off the monitor by detaching the power cable or DC power cord, wait for 6 seconds before attaching the power cable or DC power cord for normal operation.
- Please use approved power cord provided by Philips all the time. If your power cord is missing, please contact with your local service center. (Please refer to Service Regulation & Service Information Manual.)
- Operate under the specified power supply. Be sure to operate the monitor only with the specified power supply. Use of an incorrect voltage will cause malfunction and may cause fire or electric shock.
- Do not disassemble the AC adapter. Disassembling the AC adapter may expose you to the danger of fire or electric shock.
- Protect the cable. Do not pull or bend the power cable and signal cable. Do not place the monitor or any other heavy objects on the cables, if damaged, the cables may cause fire or electric shock.
- Do not subject the monitor to severe vibration or high impact conditions during operation.

## i. Important

- To avoid potential damage, for example the panel peeling from the bezel, ensure that the monitor does not tilt downward by more than -5 degrees. If the -5 degree downward tilt angle maximum is exceeded, the monitor damage will not be covered under warranty.
- Do not knock or drop the monitor during operation or transportation.
- Excessive usage of monitor can cause eye discomfort, it's better to take shorter breaks more often at your workstation than longer breaks and less often; for example a 5-10 minute break after 50-60-minute continuous screen use is likely to be better than a 15-minute break every two hours. Try to keep your eyes from eye strain while using the screen for a constant period of time by :
  - Looking at something varying distances after a long period focusing on the screen.
  - Conscious Blinking often while you work.
  - Gently closing and rolling your eyes to relax.
  - Reposition your screen to appropriate height and angle according to your height.
  - Adjusting the brightness and contrast to appropriate level.
  - Adjusting the environment lighting similar to that of your screen brightness, avoid the fluorescent lighting, and surfaces that don't reflect too much light.
  - Seeing a doctor if your symptoms.
- panel. When moving your monitor, grasp the frame to lift; do not lift the monitor by placing your hand or fingers on the LCD panel.
- Oil-based cleaning solutions may damage the plastic parts and void the warranty.
- Unplug the monitor if you are not going to use it for an extensive period of time.
- Unplug the monitor if you need to clean it with a slightly damp cloth. The screen may be wiped with a dry cloth when the power is off. However, never use organic solvent, such as, alcohol, or ammonia-based liquids to clean your monitor.
- To avoid the risk of shock or permanent damage to the set, do not expose the monitor to dust, rain, water, or excessive moisture environment.
- If your monitor gets wet, wipe it with dry cloth as soon as possible.
- If foreign substance or water gets in your monitor, please turn the power off immediately and disconnect the power cord. Then, remove the foreign substance or water, and send it to the maintenance center.
- Do not store or use the monitor in locations exposed to heat, direct sunlight or extreme cold.
- In order to maintain the best performance of your monitor and use it for a longer lifetime, please use the monitor in a location that falls within the following temperature and humidity ranges.
  - Temperature: 0-40°C 32-104°F
  - Humidity: 20-80% RH

## Maintenance

- To protect your monitor from possible damage, do not put excessive pressure on the LCD

## Important information for Burn-in/ Ghost image

## i. Important

- Always activate a moving screen saver program when you leave your monitor unattended. Always activate a periodic screen refresh application if your monitor will display unchanging static content. Uninterrupted display of still or static images over an extended period may cause “Burn-in”, also known as “after-imaging” or “ghost imaging”, on your screen.
- “Burn-in”, “after-imaging”, or “ghost imaging” is a well-known phenomenon in LCD panel technology. In most cases, the “burned in” or “after-imaging” or “ghost imaging” will disappear gradually over a period of time after the power has been switched off.

### Warning

Failure to activate a screen saver, or a periodic screen refresh application may result in severe “burn-in” or “after-image” or “ghost image” symptoms that will not disappear and cannot be repaired. The damage mentioned above is not covered under your warranty.

### Service

- The casing cover should be opened only by qualified service personnel.
- If there is any need for any document for repair or integration, please contact with your local service center. (Please refer to Service contact information listed in Regulation & Service Information Manual.)
- For transportation information, please refer to “Technical Specifications”.
- Do not leave your monitor in a car/trunk under direct sun light.

### Note

Consult a service technician if the monitor does not operate normally, or you are not sure what procedure to take when the operating instructions given in this manual have been followed.

---

## 1.2 Notational Descriptions

The following subsections describe notational conventions used in this document.

### Notes, Cautions and Warnings

Throughout this guide, blocks of text may be accompanied by an icon and printed in bold or italic type. These blocks contain notes, cautions or warnings. They are used as follows:

#### Note

This icon indicates important information and tips that help you make better use of your computer system.

#### Caution

This icon indicates information that tells you how to avoid either potential damage to hardware or loss of data.

#### Warning

This icon indicates the potential for bodily harm and tells you how to avoid the problem.

Some warnings may appear in alternate formats and may not be accompanied by an icon. In such cases, the specific presentation of the warning is mandated by the relevant regulatory authority.

## 1.3 Disposal of product and packing material

Waste Electrical and Electronic Equipment-WEEE



This marking on the product or on its packaging illustrates that, under European Directive 2012/19/EU governing used electrical and electronic appliances, this product may not be disposed of with normal household waste. You are responsible for disposal of this equipment through a designated waste electrical and electronic equipment collection. To determine the locations for dropping off such waste electrical and electronic, contact your local government office, the waste disposal organization that serves your household or the store at which you purchased the product.

Your new monitor contains materials that can be recycled and reused. Specialized companies can recycle your product to increase the amount of reusable materials and to minimize the amount to be disposed of.

All redundant packing material has been omitted. We have done our utmost to make the packaging easily separable into mono materials.

Please find out about the local regulations on how to dispose of your old monitor and packing from your sales representative.

### Taking back/Recycling Information for Customers

Philips establishes technically and economically viable objectives to optimize the environmental performance of the organization's product, service and activities.

From the planning, design and production stages, Philips emphasizes the important of making products that can easily be recycled. At Philips, end-of-life management primarily entails participation in national take-back initiatives and recycling programs whenever possible, preferably in cooperation with competitors, which recycle all materials (products and related packaging material) in accordance with all Environmental Laws and taking back program with the contractor company.

Your display is manufactured with high quality materials and components which can be recycled and reused.

To learn more about our recycling program please visit:

<http://www.philips.com/a-w/about/sustainability.html>

## 2. Setting up the monitor

### 2.1 Installation

#### 1 Package contents



AC/DC Adapter



\* DP



\* HDMI

\* Different according to region

#### Note

Use only AC/DC adapter model: Philips ADPC2090

#### 2 Install base stand

1. In order to well protect this monitor and avoid scratching or damaging of the monitor, keep the monitor face down in the cushion for the base installation.

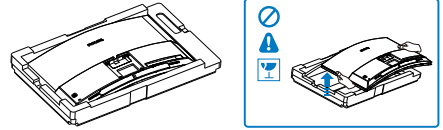

2. Hold the stand with both hands.
  - (1) Gently attach the base to the stand.
  - (2) Use your fingers to tighten the screw located at the bottom of the base.
  - (3) Use a screwdriver to tighten the screw located at the bottom of the base, and secure the base to the stand tightly.
  - (4) Gently attach the stand to the VESA mount area until the latch locks the stand.

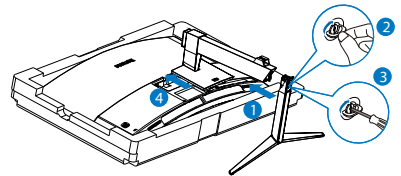

3. After attaching the base, erect the monitor with both hands on holding the monitor together with styrofoam firmly. Now you can pull out the styrofoam. When you pull out the styrofoam, do not squeeze the panel to avoid broken panel.

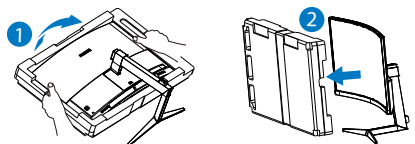

## 2. Setting up the monitor

### ⚠ Warning:

This product is curve design, when attach / detach the base, place the protective material under the monitor and do not press down the monitor to avoid the damage.

### 3 Connecting to your computer

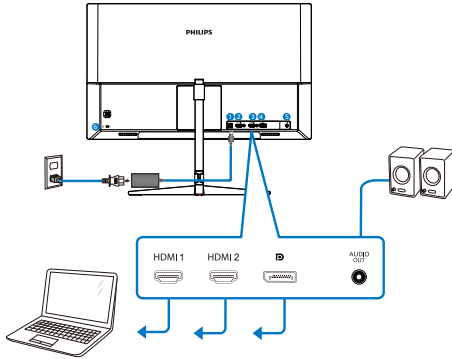

- 1 AC/DC power input
- 2 HDMI 1 input
- 3 HDMI 2 input
- 4 DisplayPort input
- 5 Audio out
- 6 Kensington anti-theft lock

#### Connect to PC

1. Connect the power cord to the back of the monitor firmly.
2. Turn off your computer and unplug its power cable.
3. Connect the monitor signal cable to the video connector on the back of your computer.
4. Plug the power cord of your computer and your monitor into a nearby outlet.
5. Turn on your computer and monitor. If the monitor displays an image, installation is complete.

## 2.2 Operating the monitor

### 1 Description of the control buttons

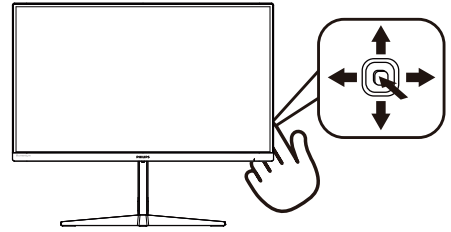

1		Press more than 3 seconds to switch display power OFF. Press to switch display power ON.
2		Access the OSD menu. Confirm the OSD adjustment.
3		Adjust the Game Setting.
		Adjust the OSD menu.
4		Change the signal input source
		Adjust the OSD menu.
5		SmartImage Game menu: There are multiple selections: FPS, Racing, RTS, Gamer 1, Gamer 2, LowBlue Mode, EasyRead, Off.
		When the monitor receives HDR signal, SmartImage will show HDR menu: There are multiple selections: HDR Game, HDR Movie, HDR Photo, Personal and Off.
		Return to previous OSD level.



## 2. Setting up the monitor

### 2 Description of the On Screen Display

#### What is On-Screen Display (OSD)?

On-Screen Display (OSD) is a feature in all Philips LCD monitors. It allows an end user to adjust screen performance or select functions of the monitors directly through an on-screen instruction window. A user friendly on screen display interface is shown as below:

#### 275M2CRZ

Game Setting	MPRT	
	MPRT Level	
LowBlue Mode	Crosshair	
	Low Input Lag	
Input	SmartResponse	
	SmartFrame	
Picture		
SmartSize		
Audio		
▼		

To access the OSD menu on this Philips display simply use the single toggle button on the rear side of the display. The single button operates like a joystick. To move the cursor, simply toggle the button in four directions. Press the button to select desired option.

#### The OSD Menu

Below is an overall view of the structure of the On-Screen Display. You can use this as a reference when you want to work your way around the different adjustments later on.

#### 275M2CRP

Game Setting	MPRT	
	MPRT Level	
LowBlue Mode	Crosshair	
	Low Input Lag	
Input	SmartResponse	
	SmartFrame	
Picture		
PIP/PBP		
SmartSize		
▼		

Basic and simple instruction on the control keys

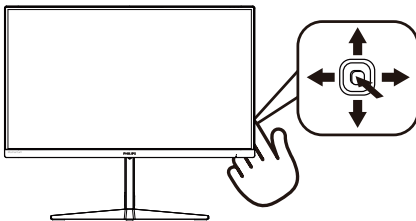

## 2. Setting up the monitor

Main menu	Sub menu		
Game Setting	MPRT	On, Off	
	MPRT Level	0-20	
	Crosshair	On, Off	
	Low Input Lag	On, Off	
	SmartResponse	Off, Fast, Faster, Fastest	
	SmartFrame	On, Off	
		Size: 1, 2, 3, 4, 5, 6, 7	
		Brightness: 0-100	
		Contrast: 0-100	
		H. position	
V. position			
Low Blue Mode	On	1,2,3,4	
	Off		
Input	1 HDMI 2.0		
	2 HDMI 2.0 DisplayPort		
Picture	SmartImage	FPS/Racing/RTS/Gamer1/Gamer2/ LowBlue Mode/EasyRead/Off	
	SmartImage HDR	HDR Game/HDR Movie/HDR Photo/ Personal/Off	
	Brightness	0-100	
	Contrast	0-100	
	Sharpness	0-100	
	SmartContrast	On, Off	
	Gamma	1.8, 2.0, 2.2, 2.4, 2.6	
	Pixel Orbiting (275M2CR2)	On, Off	
	Over Scan	On, Off	
	PIP/PBP (275M2CRP)	PIP / PBP Mode	Off, PIP, PBP
PIP / PBP Input		1 HDMI 2.0, 2 HDMI 2.0, DisplayPort	
PIP Size		Small, Middle, Large	
PIP Position		Top-Right, Top-Left, Bottom-Right, Bottom-Left	
Swap			
SmartSize	Panel Size	17" (5:4)	
		19" (5:4)	
		19"W (16:10)	
		22"W (16:10)	
		18.5"W (16:9)	
		19.5"W (16:9)	
		20"W (16:9)	
		21.5"W (16:9)	
		23"W (16:9)	
		24"W (16:9)	
27"W (16:9)			
1:1			
Aspect			
Audio	Volume	0-100	
	Mute	On, Off	
	Audio Source (275M2CRP)	HDMI1, HDMI2, DisplayPort	
Color	Color Temperature	Native, 5000K, 6500K, 7500K, 8200K, 9300K, 11500K	
	sRGB		
	User Define	Red: 0-100 Green: 0-100 Blue: 0-100	
Language	English, Deutsch, Español, Ελληνική, Français, Italiano, Magyar, Nederlands, Português, Português do Brasil, Polski, Русский, Svenska, Suomi, Türkçe, Čeština, Українська, 简体中文, 繁體中文, 日本語, 한국어		
OSD Setting	Horizontal	0-100	
	Vertical	0-100	
	Transparency	Off, 1, 2, 3, 4	
	OSD Time Out	5s, 10s, 20s, 30s, 60s	
Setup	Resolution Notification	On, Off	
	Reset	Yes, No	
	Information		

### Note

- MPRT: To reduce motion blur, LED backlight will strobe synchronously with screen refresh, which may cause noticeable brightness change.
- 75Hz refresh rate or higher is required for MPRT.
- AMD FreeSync Premium and MPRT cannot be enabled simultaneously.
- MPRT is to adjust brightness for blur reduction, so cannot adjust brightness while MPRT is turned on.
- MPRT is gaming-optimized mode. It is recommended to turn off when you are not using the gaming function.

## 2. Setting up the monitor

### 3 Resolution notification

This monitor is designed for optimal performance at its native resolution, 2560 x 1440. When the monitor is powered on at a different resolution, an alert is displayed on screen: Use 2560 x 1440 for best results.

Display of the native resolution alert can be switched off from Setup in the OSD (On Screen Display) menu.

### 4 Physical Function

Tilt

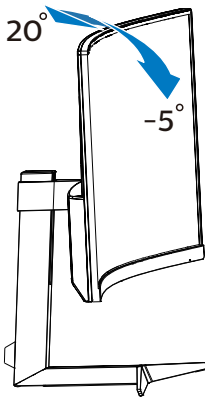

Height adjustment

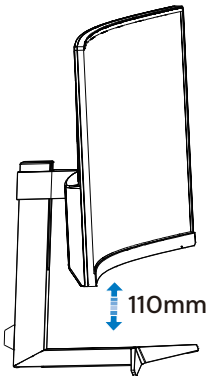

### ⚠ Warning

- To avoid potential screen damage, such as panel peeling, ensure that the monitor does not tilt downward by more than -5 degrees.
- Do not press the screen while adjusting the angle of the monitor. Grasp only the bezel.

## 2.3 Remove the Base Assembly for VESA Mounting

Before you start disassembling the Display base, please follow the instructions below to avoid any possible damage or injury.

1. Place the monitor face down on a smooth surface. Pay attention not to scratch or damage the screen.

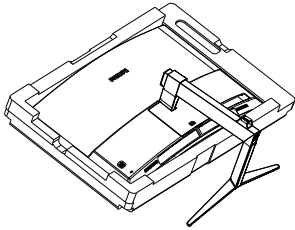

2. While keeping the release button pressed, tilt the stand and slide it out.

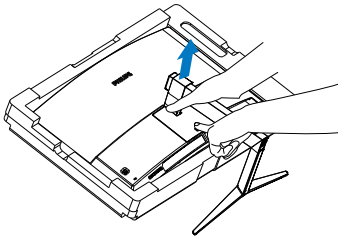

### Note

This monitor accepts a 100mm x 100mm VESA-Compliant mounting interface. VESA Mounting Screw M4. Always contact manufacturer for wall-mount installation.

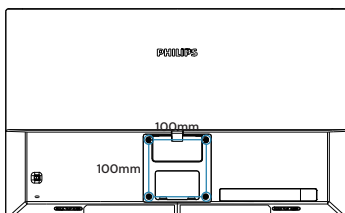

### Warning

This product is curve design, when attach / detach the base, place the protective material under the monitor and do not press down the monitor to avoid the damage.

### Note

Please purchase the appropriate wall mount; otherwise the distance between the back-plug-in signal cable and the wall would be too short.

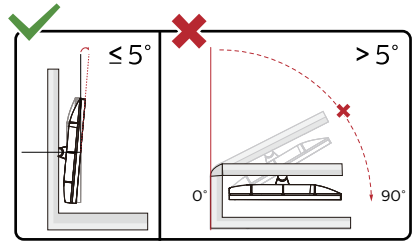

\* Display design may differ from those illustrated.

### Warning

- To avoid potential screen damage, such as panel peeling, ensure that the monitor does not tilt downward by more than  $-5$  degrees.
- Do not press the screen while adjusting the angle of the monitor. Grasp only the bezel.

## 2.4 MultiView(275M2CRP)



### 1 What is it?

Multiview enables active variety connect and view so that you can work with multiple devices like PC and Notebook side-by-side simultaneously, making complex multi-tasking work a breeze.

### 2 Why do I need it?

With the ultra high resolution Philips MultiView display, you can experience a world of connectivity in a comfortable way in the office or at home. With this display, you can conveniently enjoy multiple content sources at one screen. For example: You may want to keep an eye on the live news video feed with audio in the small window, while working on your latest blog, or you may want to edit an Excel file from your Ultrabook, while logged into secured company intranet to access files from a desktop.

### 3 How to enable MultiView by OSD menu?

Game Setting	PIP / PBP Mode	Off
	PIP / PBP Input	2 HDMI 2.0
LowBlue Mode	PIP Size	Small
	PIP Position	Top-Right
Input	Swap	
Picture		
PIP/PBP		
SmartSize		

1. Toggle to the right to enter OSD Menu Screen.
2. Toggle to the up or down to select main menu [PIP / PBP], then toggle to the right to confirm.
3. Toggle to the up or down to select [PIP / PBP Mode], then toggle to the right.
4. Toggle to the up or down to select [PIP], [PBP], then toggle to the right to confirm your selection.
5. Now you can move backward to set the [PIP / PBP Input], [PIP Size], [PIP Position] or [Swap].

Toggle to the right to confirm your selection.

### 4 MultiView in OSD menu

- PIP / PBP Mode: There are two modes for MultiView: [PIP] and [PBP].

[PIP]: Picture in Picture

Open up a sub-window of another signal source.

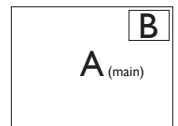

When the sub source is not detected:

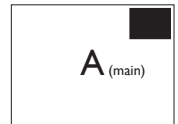

[PBP]: Picture by Picture

Open up a sub-window side-by-side of other signal sources.

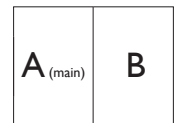

## 2. Setting up the monitor

When the sub source is not detected.



### Note

The black strip shows on the top and the bottom of the screen for the correct aspect ratio when in the PBP mode. If you expect to see full screen side by side, adjust your devices resolutions as pop up attention resolution, you will be able to see 2 devices source screen project to this display side by side without black strips. Note the analog signal is not support this full screen in PBP mode.

- PIP / PBP Input: There are different video input to choose as the sub display source: [1 HDMI 2.0], [2 HDMI 2.0], and [DisplayPort].

Please refer below table for compatibility of main/sub input source.

MultiView		SUB SOURCE POSSIBILITY (x1)		
		Inputs	1 HDMI 2.0	2 HDMI 2.0
MAIN SOURCE (x1)	1 HDMI 2.0	•	•	•
	2 HDMI 2.0	•	•	•
	DisplayPort	•	•	•

- PIP Size: When PIP is activated, there are three sub-window sizes to choose: [Small], [Middle], [Large].

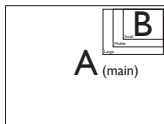

- PIP Position: When PIP is activated, there are four sub-window positions to choose.

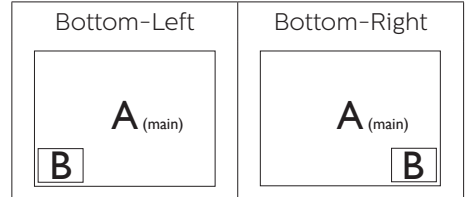
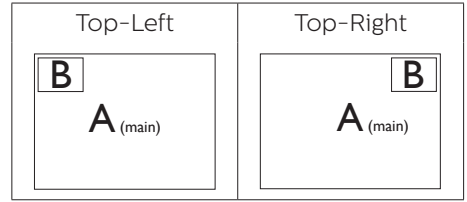

- Swap: The main picture source and the sub picture source swapped on the display.

Swap A and B source in [PIP] mode:

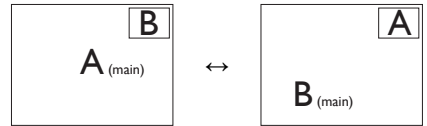

Swap A and B source in [PBP] mode:

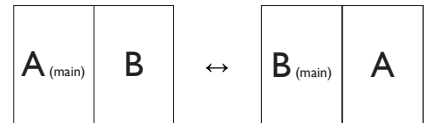

- Off: Stop MultiView function.

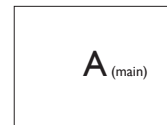

### Note

When you do the SWAP function, the video and its audio source will swap at the same time.

## 3. Image Optimization

### 3.1 SmartImage

#### 1 What is it?

SmartImage provides presets that optimize display for different types of content, dynamically adjusting brightness, contrast, color and sharpness in real time. Whether you're working with text applications, displaying images or watching a video, Philips SmartImage delivers great optimized monitor performance.

#### 2 Why do I need it?

You want a monitor that delivers optimized display all your favorite types of content, SmartImage software dynamically adjust brightness, contrast, color and sharpness in real time to enhance your monitor viewing experience.

#### 3 How does it work?

SmartImage is an exclusive, leading edge Philips technology that analyzes the content displayed on your screen. Based on a scenario you select, SmartImage dynamically enhances the contrast, color saturation and sharpness of images to enhance the contents being displayed - all in real time with the press of a single button.

#### 4 How to enable SmartImage?

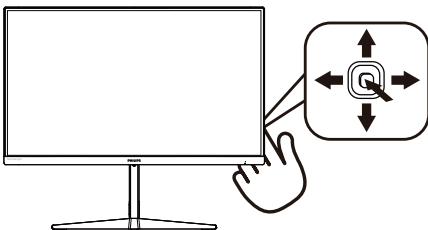

1. Toggle to the left to launch the SmartImage on screen display.
2. Toggle to the up or down to select among FPS, Racing, RTS, Gamer1, Gamer2, LowBlue Mode, EasyRead and Off.
3. The SmartImage on screen display will remain on screen for 5 seconds, or you can also toggle to the right to make confirmation.

There are multiple selections: FPS, Racing, RTS, Gamer1, Gamer2, LowBlue Mode, EasyRead and Off.

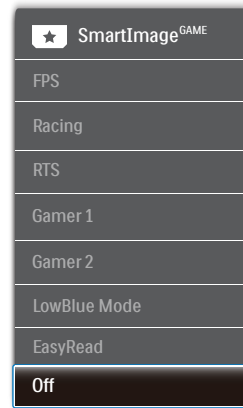

- **FPS:** For playing FPS (First Person Shooters) games. Improves dark theme black level details.
- **Racing:** For playing Racing games. Provides fastest response time and high color saturation.
- **RTS:** For playing RTS (Real Time Strategy) games, a user-selected portion can be highlighted for RTS games (through SmartFrame). The picture quality can be adjusted for the highlighted portion.
- **Gamer 1:** User's preference settings saved as Gamer 1.
- **Gamer 2:** User's preference settings saved as Gamer 2.

### 3. Image Optimization

- **LowBlue Mode:** LowBlue Mode for easy on-the-eyes productivity. Studies have shown that just as ultra-violet rays can cause eye damage, shortwave length blue light rays from LED displays can cause eye damage and affect vision over time. Developed for wellbeing, Philips LowBlue Mode setting uses a smart software technology to reduce harmful shortwave blue light.
- **EasyRead:** Helps improve reading of text based application like PDF ebooks. By using a special algorithm which increases the contrast and boundary sharpness of text content, the display is optimized for a stress-free reading by adjusting the brightness, contrast and color temperature of the monitor.
- **Off:** No optimization by SmartImage<sup>GAME</sup>.

When this display receives HDR signal from the connected device, select a picture mode that best fits your needs.

There are 5 modes to select: HDR Game, HDR Movie, HDR Photo, Personal, and Off.

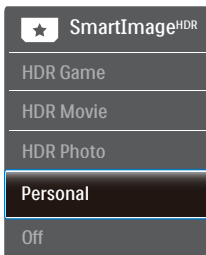

- **HDR Movie:** Ideal setting for watching HDR movie. Deliver better contrast and brightness for more realistic and immerse viewing experience.
- **HDR Photo:** Enhancing red, green, and blue for true-to-life visuals.
- **Personal:** Customize available settings in picture menu.
- **Off:** No optimization by SmartImage HDR.

#### Note

To switch off HDR function, please disable from Input device and its content. Inconsistent HDR settings between input device and monitor may cause unsatisfying images.

- **HDR Game:** Ideal setting to optimize for playing video games. With brighter white and darker black, the gaming scene is vivid and revealing more details, easily spot enemies hiding in the dark corner and shadows.



## 3.2 SmartContrast

### 1 What is it?

Unique technology that dynamically analyzes displayed content and automatically optimizes a display's contrast ratio for maximum visual clarity and viewing enjoyment, stepping up backlighting for clearer, crisper and brighter images or dimming backlighting for clear display of images on dark backgrounds.

### 2 Why do I need it?

You want the very best visual clarity and viewing comfort for every type of content. SmartContrast dynamically controls contrast and adjusts backlighting for clear, crisp, bright gaming and video images or displays clear, readable text for office work. By reducing your display's power consumption, you save on energy costs and extend the lifetime of your display.

### 3 How does it work?

When you activate SmartContrast, it will analyse the content you are displaying in real time to adjust colors and control backlight intensity. This function will dynamically enhance contrast for a great entertainment experience when viewing videos or playing games.

## 4. AMD FreeSync Premium



PC gaming has long been an imperfect experience because GPUs and monitors update at different rates. Sometimes a GPU can render many new pictures during a single update of the monitor, and the monitor will show pieces of each picture as a single image. This is called “tearing.” Gamers can fix tearing with a feature called “v-sync,” but the image can become jerky as the GPU waits on the monitor to call for an update before delivering new pictures.

The responsiveness of mouse input and overall frames per second are reduced with v-sync, too. AMD FreeSync Premium technology eliminates all of these problems by letting the GPU update the monitor the moment a new picture is ready, leaving gamers with unbelievably smooth, responsive, tearing-free games.

Followed by the graphic card that are compatible.

- Operating system
  - Windows 10/8.1/8/7
- Graphic Card: R9 290/300 Series & R7 260 Series
  - AMD Radeon R9 300 Series
  - AMD Radeon R9 Fury X
  - AMD Radeon R9 360
  - AMD Radeon R7 360
  - AMD Radeon R9 295X2
- Processor A-Series Desktop and Mobility APUs
  - AMD Radeon R9 290X
  - AMD Radeon R9 290
  - AMD Radeon R9 285
  - AMD Radeon R7 260X
  - AMD Radeon R7 260
  - AMD A10-7890K
  - AMD A10-7870K
  - AMD A10-7850K
  - AMD A10-7800
  - AMD A10-7700K
  - AMD A8-7670K
  - AMD A8-7650K
  - AMD A8-7600
  - AMD A6-7400K

## 5. HDR

HDR Settings in Windows10 system.

Steps

1. Right click on the desktop, enter to Display settings.
2. Select the display/monitor.
3. Adjust resolution to 2560 x 1440.
4. Turn the “HDR and WCG” to on mode.
5. Adjust Brightness for SDR content.

### Note

Windows10 edition is required; always upgrade to the most updated version. Below linkage is for the further more information from mircrosoft official website.

<https://support.microsoft.com/en-au/help/4040263/windows-10-hdr-advanced-color-settings>

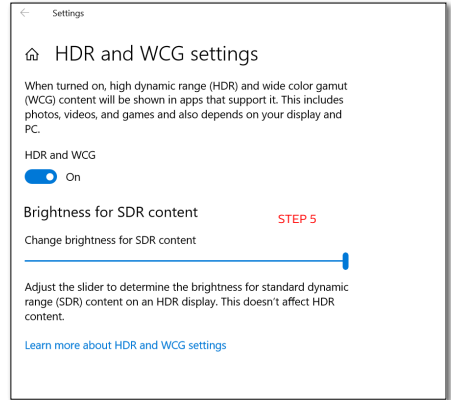

### Note

To switch off HDR function, please disable from Input device and its content. Inconsistent HDR settings between input device and monitor may cause unsatisfying images.

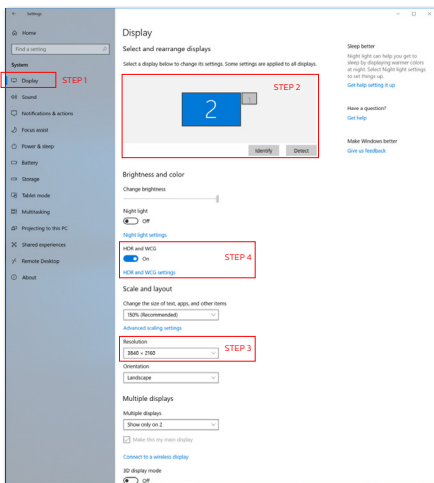

## 6. Technical Specifications

Picture/Display	
Monitor Panel Type	VA Technology
Backlight	W-LED
Panel Size	27" W (68.6 cm)
Aspect Ratio	16:9
Pixel Pitch	0.2331 (H) mm x 0.2331 (V) mm
Contrast Ratio (typ.)	275M2CRP: 2500:1 275M2CRZ: 3000:1
Recommended Resolution	2560 x 1440 @ 60Hz
Viewing Angle	178° (H) / 178° (V) @ C/R > 10
Picture Enhancement	SmartImage Game / SmartImage HDR
Vertical Refresh Rate	275M2CRZ: 48 Hz - 144 Hz(HDMI) 48 Hz - 165 Hz(DP) 275M2CRP: 48 Hz - 144 Hz(HDMI) 48 Hz - 240 Hz(DP)
Horizontal Frequency	275M2CRZ: 30 KHz - 230 KHz(HDMI) 30 KHz - 250 KHz(DP) 275M2CRP: 30 KHz - 230 KHz(HDMI) 30 KHz - 255 KHz(DP)
sRGB	YES
Color Gamut	YES
LowBlue Mode	YES
Display Colors	16.7M (8 bit)
Flicker free	YES
HDR	YES
EasyRead	YES
AMD FreeSync Premium	YES
Connectivity	
Signal Input	HDMI 2.0 x 2, DisplayPort 1.4 x 1
Input Signal	Separate Sync
Audio In/Out	Audio out
Convenience	
Built-in speaker	3W x 2

## 6. Technical Specifications

OSD Languages	English, German, Spanish, Greek, French, Italian, Hungarian, Dutch, Portuguese, Brazil Portuguese, Polish, Russian, Swedish, Finnish, Turkish, Czech, Ukranian, Simplified Chinese, Traditional Chinese, Japanese, Korean
Other Convenience	VESA mount(100 × 100 mm), Kensington Lock
Plug & Play Compatibility	DDC/CI, sRGB, Windows 10/8.1/8/7, Mac OSX

### Stand

Tilt	-5 / +20 degree
Height adjustment	110 mm

### Power(275M2CRP)

Consumption	AC Input Voltage at 100VAC , 50Hz	AC Input Voltage at 115VAC , 50Hz	AC Input Voltage at 230VAC, 50Hz
Normal Operation	43.0 W (typ.)	42.8 W (typ.)	43.3 W (typ.)
Sleep (Standby mode)	0.5 W	0.5 W	0.5 W
Off mode	0.35 W	0.35 W	0.35 W
Heat Dissipation*	AC Input Voltage at 100VAC , 50Hz	AC Input Voltage at 115VAC , 50Hz	AC Input Voltage at 230VAC , 50Hz
Normal Operation	146.76 BTU/hr (typ.)	146.08 BTU/hr (typ.)	147.78 BTU/hr (typ.)
Sleep (Standby mode)	1.71 BTU/hr	1.71 BTU/hr	1.71 BTU/hr
Off mode	1.19 BTU/hr	1.19 BTU/hr	1.19 BTU/hr
Power LED indicator	On mode: White, Standby/Sleep mode: White (blinking)		
Power Supply	External, 100-240V AC, 50-60Hz		

### Power(275M2CRZ)

Consumption	AC Input Voltage at 100VAC , 50Hz	AC Input Voltage at 115VAC , 50Hz	AC Input Voltage at 230VAC, 50Hz
Normal Operation	35.8 W (typ.)	35.6 W (typ.)	35.3 W (typ.)
Sleep (Standby mode)	0.5 W	0.5 W	0.5 W
Off mode	0.3 W	0.3 W	0.3 W
Heat Dissipation*	AC Input Voltage at 100VAC , 50Hz	AC Input Voltage at 115VAC , 50Hz	AC Input Voltage at 230VAC , 50Hz
Normal Operation	122.18 BTU/hr (typ.)	121.50 BTU/hr (typ.)	120.48 BTU/hr (typ.)
Sleep (Standby mode)	1.71 BTU/hr	1.71 BTU/hr	1.71 BTU/hr
Off mode	1.02 BTU/hr	1.02 BTU/hr	1.02 BTU/hr
Power LED indicator	On mode: White, Standby/Sleep mode: White (blinking)		
Power Supply	External, 100-240V AC, 50-60Hz		

## 6. Technical Specifications

Dimension	
Product with stand (WxHxD)	605 x 516 x 252 mm
Product without stand (WxHxD)	605 x 366 x 91 mm
Product with packaging (WxHxD)	730 x 466 x 186 mm
Weight	
Product with stand	275M2CRP: 5.40 kg 275M2CRZ: 5.39 kg
Product without stand	275M2CRP: 4.36 kg 275M2CRZ: 4.35 kg
Product with packaging	275M2CRP: 7.38 kg 275M2CRZ: 7.37 kg
Operating Condition	
Temperature range (operation)	0°C to 40 °C
Relative humidity (operation)	20% to 80%
Atmospheric pressure (operation)	700 to 1060hPa
Temperature range (Non-operation)	-20°C to 60°C
Relative humidity (Non-operation)	10% to 90%
Atmospheric pressure (Non-operation)	500 to 1060hPa
Environmental and energy	
ROHS	YES
Packaging	100% recyclable
Specific Substances	100% PVC BFR free housing
Cabinet	
Color	Black
Finish	Texture

### Note

This data is subject to change without notice. Go to [www.philips.com/support](http://www.philips.com/support) to download the latest version of leaflet.

## 6.1 Resolution & Preset Modes

### 1 Maximum Resolution

275M2CRZ  
 2560 x 1440 @ 144 Hz (HDMI)  
 2560 x 1440 @ 165 Hz (DP)  
 275M2CRP  
 2560 x 1440 @ 144 Hz (HDMI)  
 2560 x 1440 @ 240 Hz (DP)

### 2 Recommended Resolution

2560 x 1440 @ 60 Hz

H. freq (kHz)	Resolution	V. freq (Hz)
31.47	720 x 400	70.09
31.47	640 x 480	59.94
35.00	640 x 480	66.67
37.86	640 x 480	72.81
37.50	640 x 480	75.00
35.16	800 x 600	56.25
37.88	800 x 600	60.32
46.88	800 x 600	75.00
48.08	800 x 600	72.19
47.73	832 x 624	74.55
48.36	1024 x 768	60.00
56.48	1024 x 768	70.07
60.02	1024 x 768	75.03
44.77	1280 x 720	59.86
60	1280 x 960	60
63.89	1280 x 1024	60.02
79.98	1280 x 1024	75.03
89.45	1280 x 1440 PBP mode	60.00
55.94	1440 x 900	59.89
65.29	1680 x 1050	59.95
67.50	1920 x 1080	60.00
88.79	2560 x 1440	59.95
111.03	2560 x 1440	74.97
182.996	2560 x 1440	120

H. freq (kHz)	Resolution	V. freq (Hz)
222.056	2560 x 1440	144
244.366	2560 x 1440 (DP)	165
959.62	2560 x 1440 (DP)	240 (275M2CRP)

### Note

- Please notice that your display works best at native resolution of 2560 x 1440 . For best display quality, please follow this resolution recommendation.
- The highest supporting screen resolution on HDMI/DP is 2560 x 1440, but it always depends on your capability of graphics card and BluRay/video players.

## 7. Power Management

If you have VESA DPM compliance display card or software installed in your PC, the monitor can automatically reduce its power consumption when not in use. If an input from a keyboard, mouse or other input device is detected, the monitor will 'wake up' automatically. The following table shows the power consumption and signaling of this automatic power saving feature:

275M2CRP

Power Management Definition					
VESA Mode	Video	H-sync	V-sync	Power Used	LED Color
Active	ON	Yes	Yes	42.8 W (typ.), 68.9 W (max.)	White
Sleep (Standby mode)	OFF	No	No	0.5 W	White (blink)
Off mode	OFF	-	-	0.35 W	OFF

275M2CRZ

Power Management Definition					
VESA Mode	Video	H-sync	V-sync	Power Used	LED Color
Active	ON	Yes	Yes	35.6 W (typ.), 65.7 W (max.)	White
Sleep (Standby mode)	OFF	No	No	0.5 W	White (blink)
Off mode	OFF	-	-	0.3 W	OFF

The following setup is used to measure power consumption on this monitor.

- Native resolution: 2560 x 1440
- Contrast: 50%
- Brightness: 80%
- Color temperature: 6500k with full white pattern

### Note

This data is subject to change without notice.



## 8. Customer care and warranty

### 8.1 Philips' Flat Panel Monitors Pixel Defect Policy

Philips strives to deliver the highest quality products. We use some of the industry's most advanced manufacturing processes and practice stringent quality control. However, pixel or sub pixel defects on the TFT Monitor panels used in flat panel monitors are sometimes unavoidable. No manufacturer can guarantee that all panels will be free from pixel defects, but Philips guarantees that any monitor with an unacceptable number of defects will be repaired or replaced under warranty. This notice explains the different types of pixel defects and defines acceptable defect levels for each type. In order to qualify for repair or replacement under warranty, the number of pixel defects on a TFT Monitor panel must exceed these acceptable levels. For example, no more than 0.0004% of the sub pixels on a monitor may be defective. Furthermore, Philips sets even higher quality standards for certain types or combinations of pixel defects that are more noticeable than others. This policy is valid worldwide.

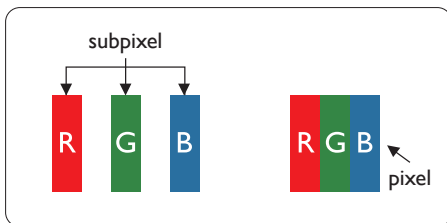

#### Pixels and Sub pixels

A pixel, or picture element, is composed of three sub pixels in the primary colors

of red, green and blue. Many pixels together form an image. When all sub pixels of a pixel are lit, the three colored sub pixels together appear as a single white pixel. When all are dark, the three colored sub pixels together appear as a single black pixel. Other combinations of lit and dark sub pixels appear as single pixels of other colors.

#### Types of Pixel Defects

Pixel and sub pixel defects appear on the screen in different ways. There are two categories of pixel defects and several types of sub pixel defects within each category.

#### Bright Dot Defects

Bright dot defects appear as pixels or sub pixels that are always lit or 'on'. That is, a bright dot is a sub-pixel that stands out on the screen when the monitor displays a dark pattern. There are the types of bright dot defects.

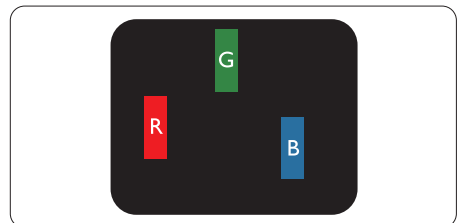

One lit red, green or blue sub pixel.

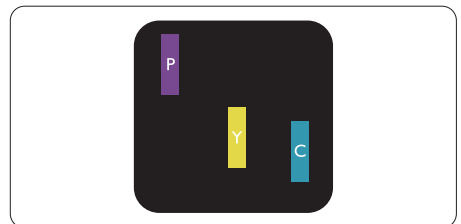

Two adjacent lit sub pixels:

- Red + Blue = Purple
- Red + Green = Yellow
- Green + Blue = Cyan (Light Blue)

## 8. Customer care and warranty

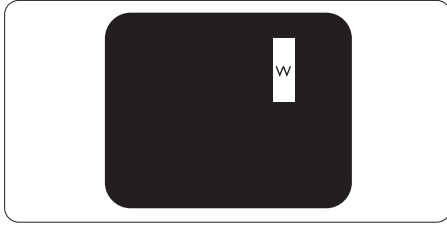

Three adjacent lit sub pixels (one white pixel).

### Note

A red or blue bright dot must be more than 50 percent brighter than neighboring dots while a green bright dot is 30 percent brighter than neighboring dots.

### Black Dot Defects

Black dot defects appear as pixels or sub pixels that are always dark or 'off'. That is, a dark dot is a sub-pixel that stands out on the screen when the monitor displays a light pattern. These are the types of black dot defects.

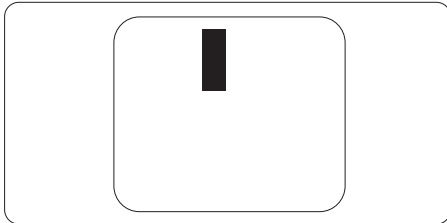

### Proximity of Pixel Defects

Because pixel and sub pixels defects of the same type that are near to one another may be more noticeable, Philips also specifies tolerances for the proximity of pixel defects.

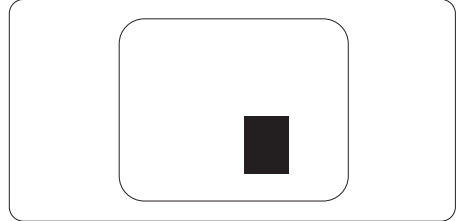

### Pixel Defect Tolerances

In order to qualify for repair or replacement due to pixel defects during the warranty period, a TFT Monitor panel in a Philips flat panel monitor must have pixel or sub pixel defects exceeding the tolerances listed in the following tables.

## 8. Customer care and warranty

<b>BRIGHT DOT DEFECTS</b>	<b>ACCEPTABLE LEVEL</b>
1 lit subpixel	2
2 adjacent lit subpixels	1
3 adjacent lit subpixels (one white pixel)	0
Distance between two bright dot defects*	>15 mm
Total bright dot defects of all types	3

<b>BLACK DOT DEFECTS</b>	<b>ACCEPTABLE LEVEL</b>
1 dark subpixel	5 or fewer
2 adjacent dark subpixels	2
3 adjacent dark subpixels	0
Distance between two black dot defects*	>15 mm
Total black dot defects of all types	5 or fewer

<b>TOTAL DOT DEFECTS</b>	<b>ACCEPTABLE LEVEL</b>
Total bright or black dot defects of all types	5 or fewer

### Note

1 or 2 adjacent sub pixel defects = 1 dot defect

## 8.2 Customer Care & Warranty

For warranty coverage information and additional support requirements valid for your region, please visit [www.philips.com/support](http://www.philips.com/support) website for details or contact your local Philips Customer Care Center.

For Warranty Period please refer to Warranty Statement in Regulation & Service Information Manual.

For extended warranty, if you would like to extend your general warranty period, an Out of Warranty service package is offered via our Certified Service Center.

If you wish to make use of this service, please be sure to purchase the service within 30 calendar days of your original purchase date. During the extended warranty period, the service includes pickup, repair and return service, however the user will be responsible for all costs accrued.

If the Certified Service Partner cannot perform the required repairs under the offered extended warranty package, we will find alternative solutions for you, if possible, up to the extended warranty period you have purchased.

Please contact our Philips Customer Service Representative or local contact center (by Consumer care number) for more details.

Philips Customer Care Center number listed below.

• Local Standard Warranty Period	• Extended Warranty Period	• Total Warranty Period
• Depend on different Regions	• + 1 Year	• Local Standard warranty period +1
	• + 2 Years	• Local Standard warranty period +2
	• + 3 Years	• Local Standard warranty period +3

\*\*Proof of original purchase and extended warranty purchase required.

### Note

Please refer to Regulation & Service Information Manual for regional service hotline, which is available on the Philips website support page.

## 9. Troubleshooting & FAQs

### 9.1 Troubleshooting

This page deals with problems that can be corrected by a user. If the problem still persists after you have tried these solutions, contact Philips customer service representative.

#### 1 Common Problems

##### No Picture (Power LED not lit)

- Make sure the power cord is plugged into the power outlet and into the back of the monitor.
- First, ensure that the power button on the rear side of the display is in the OFF position, then press it to the ON position.

##### No Picture (Power LED is White)

- Make sure the computer is turned on.
- Make sure the signal cable is properly connected to your computer.
- Make sure the monitor cable has no bent pins on the connect side. If yes, repair or replace the cable.
- The Energy Saving feature may be activated

##### Screen says

Check cable connection

- Make sure the monitor cable is properly connected to your computer. (Also refer to the Quick Start Guide).
- Check to see if the monitor cable has bent pins.

- Make sure the computer is turned on.

##### Visible signs of smoke or sparks

- Do not perform any troubleshooting steps
- Disconnect the monitor from mains power source immediately for safety
- Contact with Philips customer service representative immediately.

#### 2 Imaging Problems

##### Image vibrates on the screen

- Check that the signal cable is properly securely connected to the graphics board or PC.

##### Image appears blurred, indistinct or too dark

- Adjust the contrast and brightness on On-Screen Display.

##### An "after-image", "burn-in" or "ghost image" remains after the power has been turned off.

- Uninterrupted display of still or static images over an extended period may cause "burn-in", also known as "after-imaging" or "ghost imaging", on your screen. "Burn-in", "after-imaging", or "ghost imaging" is a well-known phenomenon in monitor panel technology. In most cases, the "burned in" or "after-imaging" or "ghost imaging" will disappear gradually over a period of time after the power has been switched off.
- Always activate a moving screen saver program when you leave your monitor unattended.
- Always activate a periodic screen refresh application if your monitor will display unchanging static content.
- Failure to activate a screen saver, or a periodic screen refresh application

may result in severe “burn-in” or “after-image” or “ghost image” symptoms that will not disappear and cannot be repaired. The damage mentioned above is not covered under your warranty.

**Image appears distorted. Text is fuzzy or blurred.**

- Set the PC’s display resolution to the same mode as monitor’s recommended screen native resolution.

**Green, red, blue, dark, and white dots appears on the screen**

- The remaining dots are normal characteristic of the liquid crystal used in today’s technology, Please refer the pixel policy for more detail.

For further assistance, refer to the Service contact information listed in Regulation & Service Information Manual and contact Philips customer service representative.

### 3 Audio problem

**No sound**

- Check if audio cable is connected to PC and monitor correctly.
- Ensure audio is not muted. Press OSD “Menu”, select “Audio” then “Mute”. Check it on “Off” position.
- Press “Volume” in OSD main control to adjust the volume.

---

## 9.2 General FAQs

**Q1:** When I install my monitor what should I do if the screen shows 'Cannot display this video mode'?

**Ans.:** Recommended resolution for this monitor: 2560 x 1440.

- Unplug all cables, then connect your PC to the monitor that you used previously.
- In the Windows Start Menu, select Settings/Control Panel. In the Control Panel Window, select the Display icon. Inside the Display Control Panel, select the 'Settings' tab. Under the setting tab, in box labelled 'desktop area', move the sidebar to 2560 x 1440 pixels.
- Open 'Advanced Properties' and set the Refresh Rate to 60 Hz, then click OK.
- Restart your computer and repeat step 2 and 3 to verify that your PC is set at 2560 x 1440 .
- Shut down your computer, disconnect your old monitor and reconnect your Philips monitor.
- Turn on your monitor and then turn on your PC.

**Q2:** What are the .inf and .icm files? How do I install the drivers (.inf and .icm)?

**Ans.:** These are the driver files for your monitor. Your computer may ask you for monitor drivers (.inf and .icm files) when you first install your monitor. Follow the instructions in your user manual, monitor drivers (.inf and .icm files) will be installed automatically.

**Q3:** How do I adjust the resolution?

**Ans.:** Your video card/graphic driver and monitor together determine the available resolutions. You can select the desired resolution under Windows® Control Panel with the "Display properties".

**Q4:** What if I get lost when I am making monitor adjustments via OSD?

**Ans.:** Simply press the  button, then select [Reset] to recall all the original factory settings.

**Q5:** Is the monitor screen resistant to scratches?



**Ans.:** In general it is recommended that the panel surface is not subjected to excessive shocks and is protected from sharp or blunt objects. When handling the monitor, make sure that there is no pressure or force applied to the panel surface side. This may affect your warranty conditions.

**Q6:** How should I clean the monitor surface?

**Ans.:** For normal cleaning, use a clean, soft cloth. For extensive cleaning, please use isopropyl alcohol. Do not use other solvents such as ethyl alcohol, ethanol, acetone, hexane, etc.

**Q7:** Can I change the color setting of my monitor?

**Ans.:** Yes, you can change your color setting through OSD control as the following procedures:

- Press  button to show the OSD (On Screen Display) menu
- Press  button to select the option [Color] then press  button to

enter color setting, there are three settings as below.

1. Color Temperature: The seven settings are Native, 5000K, 6500K, 7500K, 8200K, 9300K and 11500K. With settings in the 5000K range the panel appears "warm, with a red-white color tone", while a 11500K temperature yields "cool, bluishwhite toning".
2. sRGB: This is a standard setting for ensuring correct exchange of colors between different device (e.g. digital cameras, monitors, printers, scanners, etc).
3. User Define: The user can choose his/her preference color setting by adjusting red, green, blue color.

### Note

A measurement of the color of light radiated by an object while it is being heated. This measurement is expressed in terms of absolute scale, (degrees Kelvin). Lower Kelvin temperatures such as 2004K are red; higher temperatures such as 9300K are blue. Neutral temperature is white, at 6504K.

**Q8:** Can I connect my monitor to any PC, workstation or Mac?

**Ans.:** Yes. All Philips monitors are fully compatible with standard PCs, Macs and workstations. You may need a cable adapter to connect the monitor to your Mac system. Please contact your Philips sales representative for more information.

## 9. Troubleshooting & FAQs

**Q9:** Are Philips monitors Plug-and-Play?

**Ans.:** Yes, the monitors are Plug-and-Play compatible with Windows 10/8.1/8/7, Mac OS X

**Q10:** What is Image Sticking, or Image Burn-in, or After Image, or Ghost Image in monitor panels?

**Ans.:** Uninterrupted display of still or static images over an extended period may cause "burn-in", also known as "after-imaging" or "ghost imaging", on your screen. "Burn-in", "after-imaging", or "ghost imaging" is a well-known phenomenon in monitor panel technology. In most cases, the "burned in" or "after-imaging" or "ghost imaging" will disappear gradually over a period of time after the power has been switched off.

Always activate a moving screen saver program when you leave your monitor unattended.

Always activate a periodic screen refresh application if your monitor will display unchanging static content.

### Warning

Failure to activate a screen saver, or a periodic screen refresh application may result in severe "burn-in" or "after-image" or "ghost image" symptoms that will not disappear and cannot be repaired. The damage mentioned above is not covered under your warranty.

**Q11:** Why is my Display not showing sharp text, and is displaying jagged characters?

**Ans.:** Your monitor works best at its native resolution of 2560 x 1440. For best display, please use this resolution.

**Q12:** How to unlock/lock my hot key?

**Ans.:** Please press  for 10 seconds to unlock/lock the hot key, by doing so, your monitor pops out "Attention" to show the unlock/lock status as shown below illustrators.



Monitor controls unlocked

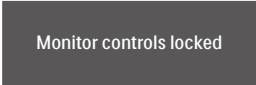

Monitor controls locked

**Q13:** Where can I find Regulation & Service Information Manual mentioned in EDFU?

**Ans.:** Regulation & Service Information Manual can be download on the Philips website support page.





2020 © TOP Victory Investments Ltd. All rights reserved.

This product has been manufactured by and is sold under the responsibility of Top Victory Investments Ltd., and Top Victory Investments Ltd. is the warrantor in relation to this product. Philips and the Philips Shield Emblem are registered trademarks of Koninklijke Philips N.V. and are used under license.

Specifications are subject to change without notice.

Version: 275M2CRE1T