

221TE5

241TE5

English



www.philips.com/welcome

EN	Notice & important information	2
	User manual	5
	Troubleshooting	35

PHILIPS



Country	Code	Telephone number	Tariff
Austria	+43	0810 000206	€ 0.07
Belgium	+32	078 250851	€ 0.06
Denmark	+45	3525 8761	Local call tariff
Finland	+358	09 2290 1908	Local call tariff
France	+33	082161 1658	€ 0.09
Germany	+49	01803 386 853	€ 0.09
Greece	+30	00800 3122 1223	Free of charge
Ireland	+353	01 601 1161	Local call tariff
Italy	+39	840 320 041	€ 0.08
Luxembourg	+352	26 84 30 00	Local call tariff
The Netherlands	+31	0900 0400 063	€ 0.10
Norway	+47	2270 8250	Local call tariff
Poland	+48	0223491505	Local call tariff
Portugal	+351	2 1359 1440	Local call tariff
Spain	+34	902 888 785	€ 0.10
Sweden	+46	08 632 0016	Local call tariff
Switzerland	+41	02 2310 2116	Local call tariff
United Kingdom	+44	0207 949 0069	Local call tariff

Register your product and get support at
www.philips.com/welcome

This information is correct at the time of press. For updated information, see www.philips.com/support.

Contents

1	Notice	2
----------	---------------	----------

2	Important	3
	The most updated user manual on line	4

3	Get started and connect your devices	5
	Back connector	5
	Side connector	6
	Use a Conditional Access Module	7
	Use Philips EasyLink	7

4	Controls	9
	Side control buttons	9
	Remote control	10

5	Start to use	11
	Switch your monitor on/off or to standby	11
	Switch channels	12
	Watch connected devices	12
	Adjust monitor volume	13

6	Product information	14
	Picture/Display	14
	Supported Display Resolution	14
	Sound	14
	Convenience	14
	Stand	14
	Tuner/Reception/Transmission	15
	Connectivity	15
	Power	15
	Dimensions	15
	Weight	15
	Accessories	15
	Supported monitor mounts	15

7	TV/Channel installation	16
	Automatically install channels	16
	Manually install channels	17
	Rename channels	17
	Rearrange channels	18
	Test digital reception	18

8	Settings	19
	Access TV menus	19
	Change picture and sound settings	19
	Use the universal access menu	21
	Use advanced teletext features	22
	Create and use lists of favourite channels	23
	Use the Electronic Programme Guide	24
	Display the TV clock	24
	Use timers	25
	Lock unsuitable content	26
	Change language	26
	Update the TV software	27
	Change TV preferences	28
	Start a TV demo	29
	Reset the TV to factory settings	29

9	Multimedia	30
	Play photos, music, and video on USB storage devices	30

10	Pixel policy	32
-----------	---------------------	-----------

11	Troubleshooting	35
	General monitor issues	35
	TV channel issues	35
	Picture issues	35
	Sound issues	36
	HDMI connection issues	36
	Computer connection issues	36
	Contact us	36

1 Notice

2013 © Koninklijke Philips Electronics N.V.
All rights reserved.

Philips and the Philips Shield Emblem are registered trademarks of Koninklijke Philips Electronics N.V. and are used under licence from Koninklijke Philips Electronics N.V.

Specifications are subject to change without notice.

Warranty

- Risk of injury, damage to monitor or void of warranty! Never attempt to repair the monitor yourself.
- Use the monitor and accessories only as intended by the manufacturer.
- Any operation expressly prohibited in this manual, or any adjustments and assembly procedures not recommended or authorised in this manual shall void the warranty.
- Warranty coverage begins from the day you purchase your monitor. For two years thereafter, your monitor will be replaced by at least an equivalent monitor in case of defects provided by the warranty coverage.

Pixel characteristics

This monitor product has a high number of color pixels. Although it has effective pixels of 99.999% or more, black dots or bright points of light (red, green or blue) may appear constantly on the screen. This is a structural property of the display (within common industry standards) and is not a malfunction.

Please refer to the Pixel Policy section in this manual for details.

Mains fuse (UK only)

This TV monitor is fitted with an approved moulded plug. Should it become necessary to replace the mains fuse, this must be replaced with a fuse of the same value as indicated on the plug (example 10A).

- 1 Remove fuse cover and fuse.
- 2 The replacement fuse must comply with BS 1362 and have the ASTA approval mark. If the fuse is lost, contact your dealer in order to verify the correct type.
- 3 Refit the fuse cover.
In order to maintain conformity to the EMC directive, the mains plug on this product must not be detached from the mains cord cable.

Copyright



VESA, FDMI and the VESA Mounting Compliant logo are trademarks of the Video Electronics Standards Association.

® Kensington and Micro Saver are registered US trademarks of ACCO World Corporation with issued registrations and pending applications in other countries throughout the world.



Manufactured under license from Dolby Laboratories. Dolby and the double-D symbol are trademarks of Dolby Laboratories.

2 Important

Read and understand all instructions before you use your monitor. If damage is caused by failure to follow instructions, the warranty does not apply.

Safety

- Risk of electric shock or fire!
 - Never expose the monitor to rain or water. Never place liquid containers, such as vases, near the monitor. If liquids are spilt on or into the monitor, disconnect the monitor from the power outlet immediately. Contact Philips Consumer Care to have the monitor checked before use.
 - Never place the monitor, remote control or batteries near naked flames or other heat sources, including direct sunlight. To prevent the spread of fire, keep candles or other flames away from the monitor, remote control and batteries at all times.
- 
- Never insert objects into the ventilation slots or other openings on the monitor.
 - When the monitor is swivelled, ensure that no strain is exerted on the power cord. Strain on the power cord can loosen connections and cause arcing.
 - Risk of short circuit or fire!
 - Never expose the remote control or batteries to rain, water or excessive heat.
 - Avoid force coming onto power plugs. Loose power plugs can cause arcing or fire.
- Risk of injury or damage to the monitor!
 - Two people are required to lift and carry a monitor that weighs more than 25 kg.
 - When stand mounting the monitor, use only the supplied stand. Secure the stand to the monitor tightly. Place the monitor on a flat, level surface that can support the combined weight of the monitor and the stand.
 - When wall mounting the monitor, use only a wall mount that can support the weight of the monitor. Secure the wall mount to a wall that can support the combined weight of the monitor and wall mount. Koninklijke Philips Electronics N.V. bears no responsibility for improper wall mounting that results in accident, injury or damage.
 - Risk of injury to children! Follow these precautions to prevent the monitor from toppling over and causing injury to children:
 - Never place the monitor on a surface covered by a cloth or other material that can be pulled away.
 - Ensure that no part of the monitor hangs over the edge of the surface.
 - Never place the monitor on tall furniture (such as a bookcase) without anchoring both the furniture and monitor to the wall or a suitable support.
 - Educate children about the dangers of climbing on furniture to reach the monitor.
 - Risk of overheating! Never install the monitor in confined space. Always leave at least 4 inches of space around the monitor for ventilation. Ensure curtains or other objects never cover the ventilation slots on the monitor.
 - Risk of damage to the monitor! Before you connect the monitor to the power outlet, ensure that the power voltage matches the value printed on the back of the monitor. Never connect the monitor to the power outlet if the voltage is different.

- Risk of injury, fire or power cord damage! Never place the monitor or any objects on the power cord.
- To easily disconnect the monitor power cord from the power outlet, ensure that you have full access to the power cord at all times.
- When you disconnect the power cord, always pull the plug, never the cable.
- Disconnect the monitor from the power outlet and aerial before lightning storms. During lightning storms, never touch any part of the monitor, power cord or aerial cable.
- Risk of hearing damage! Avoid using earphones or headphones at high volumes or for prolonged periods of time.
- If the monitor is transported in temperatures below 5°C, unpack the monitor and wait until the monitor temperature matches the room temperature before connecting the monitor to the power outlet.

Screen care

- Avoid stationary images as much as possible. Stationary images are images that remain on-screen for extended periods of time. Examples include: on-screen menus, black bars and time displays. If you must use stationary images, reduce screen contrast and brightness to avoid screen damage.
- Unplug the monitor before cleaning.
- Clean the monitor and frame with a soft, damp cloth. Never use substances such as alcohol, chemicals or household cleaners on the monitor.
- Risk of damage to the monitor screen! Never touch, push, rub or strike the screen with any object.
- To avoid deformations and color fading, wipe off water drops as soon as possible.

Recycling



Your display is manufactured with high quality materials and components which can be recycled and reused.

To learn more about our recycling program, please visit www.philips.com/about/sustainability/recycling.

When you see the crossed-out wheeled bin symbol attached to a product, it means the product is covered by the European Directive 2002/96/EC:



Never dispose of your product with other household waste. Please inform yourself about the local rules on the separate collection of electrical and electronic products. The correct disposal of your old product helps prevent potentially negative consequences for the environment and human health.

Your product contains batteries covered by the European Directive 2006/66/EC, which cannot be disposed of with normal household waste.

Please inform yourself about the local rules on the separate collection of batteries. The correct disposal of batteries helps prevent potentially negative consequences for the environment and human health.

The most updated user manual on line

The contents of the user manual are subject to change. Please refer to www.philips.com/support for the most updated user manual info reference.

3 Get started and connect your devices

Congratulations on your purchase, and welcome to Philips! To fully benefit from the support that Philips offers, register your product at www.philips.com/welcome.

This section describes how to connect various devices with different connectors and supplements examples provided in the Quick Start Guide.

Note

- Different types of connectors may be used to connect a device to your monitor, depending on availability and your needs.

Back connector

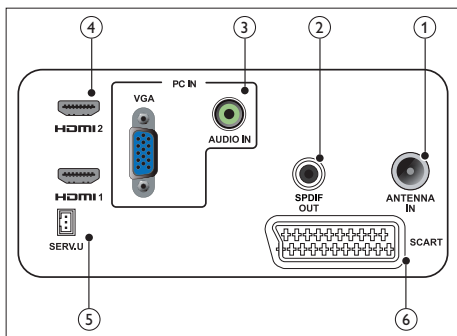

① TV ANTENNA

Signal input from an antenna, cable or satellite.

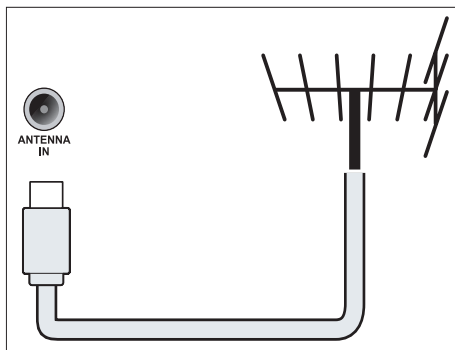

② SPDIF OUT

Digital audio output to home theaters and other digital audio systems.

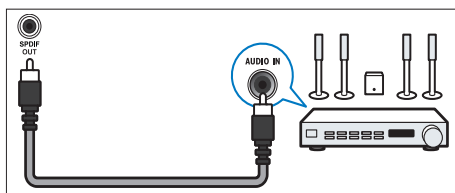

③ PC IN (VGA and AUDIO IN)

Audio and video input from a computer.

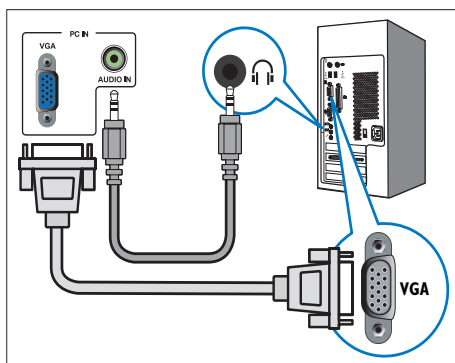

The connection via VGA requires an additional audio cable.

④ HDMI

Digital audio and video input from high-definition digital devices such as Blu-ray players.

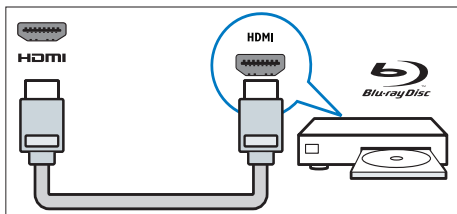

⑤ SERV. U

For use by service personnel only.

⑥ SCART (RGB / CVBS)

Analogue audio and video input from analogue or digital devices such as DVD players or game consoles.

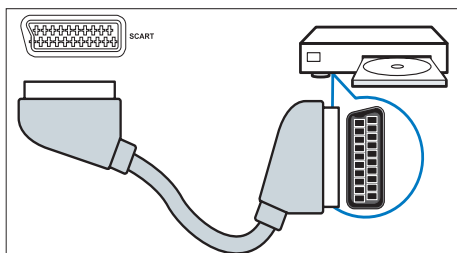

Side connector

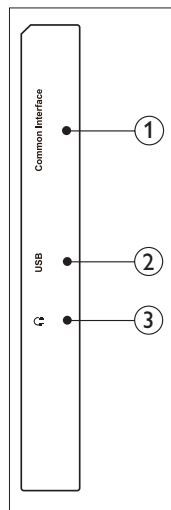

① COMMON INTERFACE

Slot for a Conditional Access Module (CAM).

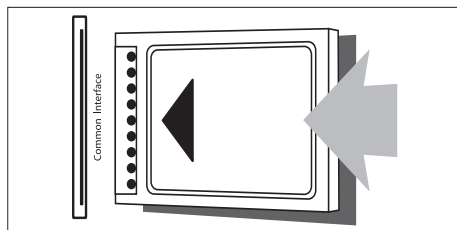

② USB

For music, photo, and video.

③ HEADPHONE

Audio output to your headphones.

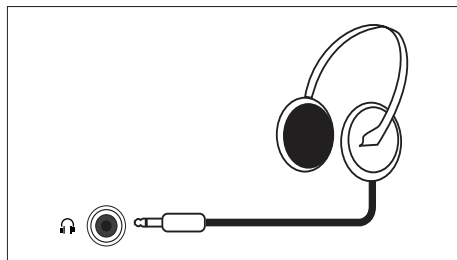

Use a Conditional Access Module

A Conditional Access Module (CAM) is provided by digital TV service operators to decode digital TV channels.

Note

- Refer to the documentation from your service operator on how to insert a smart card into the Conditional Access Module.

Insert and activate a CAM

Caution

- Be sure to follow the instructions described below. Wrong insertion of a CAM may damage both the CAM and your TV.

1. Switch off the TV and disconnect it from the power outlet.
2. Following the directions printed on the CAM, gently insert the CAM into the **COMMON INTERFACE** at the side of the TV.
3. Push the CAM in as far as it will go.
4. Reconnect the TV to the power outlet.
5. Turn on the TV and wait for the CAM to be activated. This may take several minutes. Do not remove the CAM from the slot when in use — this action deactivates digital services.

Access CAM services

1. Insert and activate the CAM.
2. Press  **OPTIONS**.
3. Select **[Common interface]**.
 - ↳ Applications provided by the digital TV service operator are displayed.

Note

- This menu option is available only if the CAM is inserted and activated correctly.

Use Philips EasyLink

Get the most out of your HDMI-Consumer Electronic Control (CEC) compliant device with Philips EasyLink enhanced control features.

To enable Philips EasyLink, you need to:

- Connect an HDMI-CEC compliant device through HDMI
- Configure the HDMI-CEC compliant device properly
- Switch on EasyLink

Note

- The EasyLink-compliant device must be switched on and selected as the source.
- Philips does not guarantee 100% interoperability with all HDMI CEC devices.

Switch on or off EasyLink

When you play an HDMI-CEC compliant device, the TV switches on from standby, and switches to the correct source.

Note

- If you do not intend to use Philips EasyLink, switch it off.

1. Press .
2. Select **[Setup] > [TV settings] > [EasyLink] > [EasyLink]**.
3. Select **[On]** or **[Off]**, then press **OK**.

Set TV speakers to EasyLink mode

If you connect an HDMI-CEC compliant device that includes speakers, you can choose to hear the TV from those speakers instead of the TV speakers.

When you play content from an EasyLink compliant home theatre, if you want to mute the TV speakers automatically, turn on EasyLink mode.

1. Connect an HDMI-CEC compliant device to the HDMI connector.
2. Connect an audio cable from the SPDIF OUT connector to the EasyLink-compliant device's AUDIO IN connector (see 'Back connections' on page 5).
3. Configure the HDMI-CEC compliant device properly (see the device user manual).
4. Press **⬆**.
5. Select **[Setup] > [TV settings] > [EasyLink] > [EasyLink]**.
6. Select **[On]**, then press **OK**.
7. Select **[TV speakers]**, then press **OK**.
8. Select one of the following, then press **OK**.
 - **[Off]**: Switch off TV speakers.
 - **[On]**: Switch on TV speakers.
 - **[EasyLink]**: Stream TV audio through the connected HDMI-CEC device. Switch the TV audio to the connected HDMI-CEC audio device through the adjust menu.

 **Note**

- To mute the TV speakers, select **[TV speakers] > [Off]**.

Select speaker output with Adjust menu

If **[EasyLink]** is selected, access the adjust menu to switch the TV audio.

1. While you watch TV, press **≡ ADJUST**.
2. Select **[Speaker]**, then press **OK**.
3. Select one of the following, then press **OK**:
 - **[TV]**: On by default. Stream TV audio through TV and the connected HDMI-CEC audio device until the connected device switches to system audio control. TV audio is then streamed through the connected device.
 - **[Amplifier]**: Stream audio through the connected HDMI-CEC device. If system audio mode is not enabled on the device, audio continue to stream from the TV speakers.

4 Controls

Side control buttons

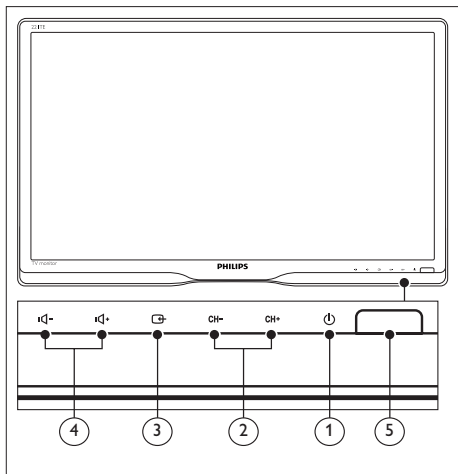

- ① **⏻ POWER:** Switch the monitor on or off. The monitor is not powered off completely unless it is physically unplugged.
- ② **CH +/-:** Switch to the next or previous channel.
- ③ **📺 SOURCE:**
Select an input source.
Return to the previous screen or exit from the on-screen menu.
- ④ **🔊 / 🔊+ :** Increase or decrease volume.
- ⑤ **Power indicator:**
Red LED: RC standby mode. / PC standby mode.

Remote control

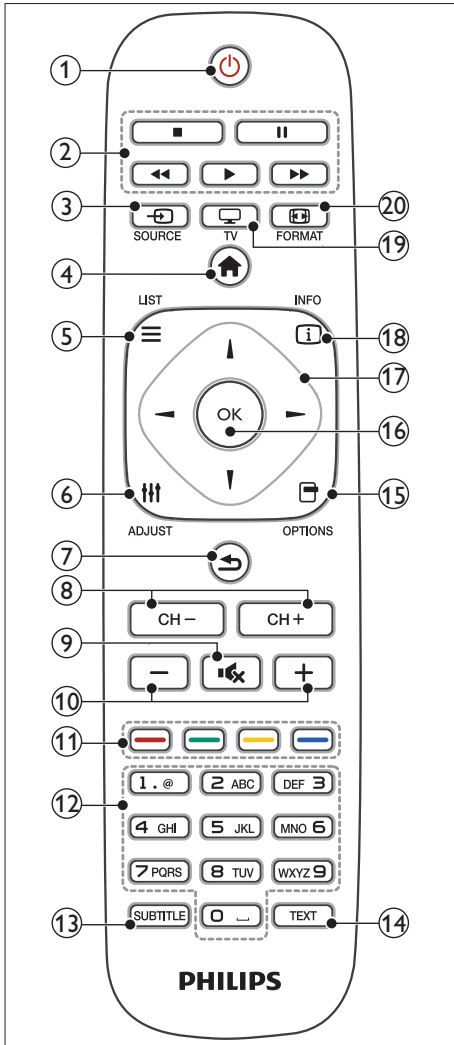

- ① **⏻ (Standby-On)**
- Switch the monitor to standby if the monitor is on.
 - Switch the monitor on if the monitor is in standby.
- ② **▶ (Play buttons)**
Control video or music.

- ③ **📺 SOURCE**
Select connected devices.
- ④ **🏠 (Home)**
Access the home menu.
- ⑤ **☰ LIST**
Access the menu to select a TV channel list.
- ⑥ **⚙️ ADJUST**
Access the menu to adjust settings.
- ⑦ **⬅️ (Back)**
- Return to the previous screen.
 - Return to the last viewed channel.
- ⑧ **CH - / CH +**
Switch channels.
- ⑨ **🔇 (Mute)**
Switch the sound On or Off.
- ⑩ **+/- (Volume)**
Increase or decrease the volume.
- ⑪ **Colour buttons**
Select tasks or options.
- ⑫ **0-9 (Numeric buttons)**
Select a channel.
- ⑬ **SUBTITLE**
Enable or disable subtitles.
- ⑭ **TEXT**
Enable or disable teletext
- ⑮ **📄 OPTIONS**
Access options for the current activity or selection.
- ⑯ **OK**
Confirm an entry or selection.
- ⑰ **▲▼◀▶ (Navigation buttons)**
Navigate through menus and select items.
- ⑱ **📄 INFO**
Display information about current activity.
- ⑲ **📺 TV**
Switch source to watch TV.
- ⑳ **🖼️ FORMAT**
Change picture format.

5 Start to use

This section helps you perform basic monitor operations.

Switch your monitor on/off or to standby

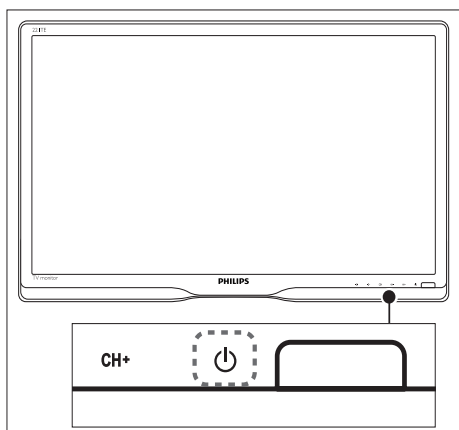
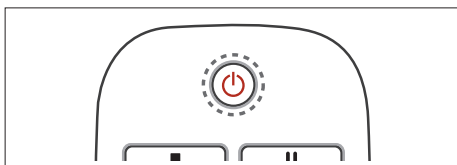

To switch on

- If the standby indicator is off, press **POWER** under the front bezel.
- If the standby indicator is red, press **(Standby-On)** on the remote control.

To switch to standby

- Press **(Standby-On)** on the remote control.
 - ↳ The standby indicator switches to red.

To switch off

- Press **POWER** under the front bezel.
 - ↳ The standby indicator switches off.



Tip

- Though your monitor consumes very little power when in standby, energy continues to be consumed. When not in use for an extended period of time, disconnect the monitor power cable from the power outlet.



Note

- If you cannot locate your remote control and want to switch on the monitor from standby, press **POWER** under the front bezel.

Switch channels

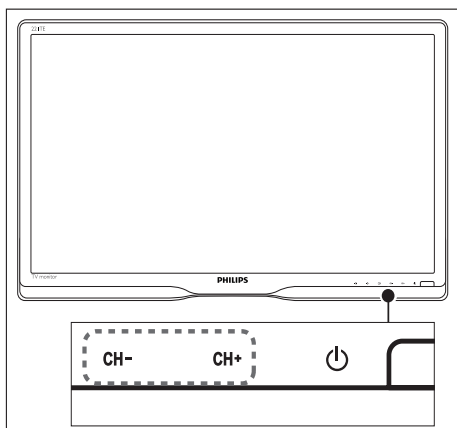
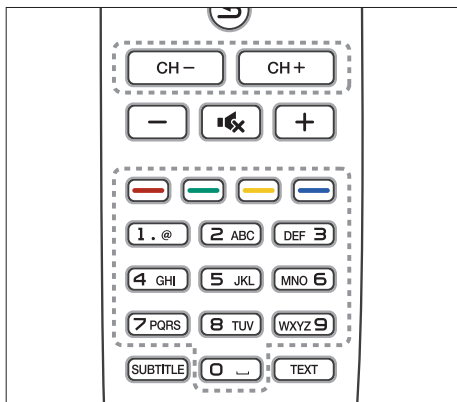

- Press **CH +/-**, or enter a channel number using the numeric buttons on the remote control.
- Press the **CH +/-** button at the front of the monitor.

Watch connected devices

Note

- Switch on the connected device before selecting it as a source on the monitor.

To select from the SOURCE button

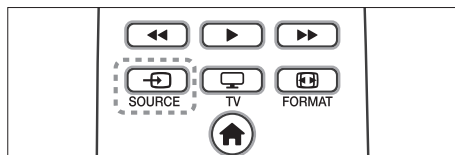



1. Press **SOURCE** to display the source list.
↳ The source list appears.
2. Press **SOURCE**, **▲** or **▼** to select a device.
3. Press **OK** to confirm your selection.

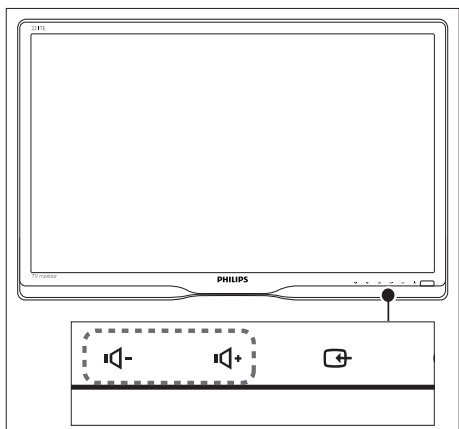
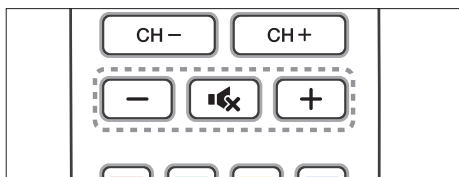

Adjust monitor volume



To turn up or down the volume

- Press +/- on the remote control.
- Press  /  buttons at the front of the monitor

To mute or restore the muted sound

- Press  to mute the sound.
- Press  again to restore the sound.

6 Product information

Product information is subject to change without notice. For detailed product information, go to www.philips.com/support.

Picture/Display

- LCD panel type: TFT-LCD
- Backlight type: W-LED system
- Diagonal screen size:
 - 221TE5: 21.5 inch / 54.6 cm
 - 241TE5: 23.6 inch / 59.9 cm
- Aspect ratio: 16:9, Widescreen
- Panel resolution: 1920 x 1080
- Response time (typical): 5 ms
- Brightness: 250 cd/m²
- SmartContrast: 20000000:1
- Viewing angle: 170° (H) / 160° (V),
@ C/R > 10
- Contrast ratio (typical): 1000:1
- Picture enhancement: Progressive scan
- Screen enhancement: Anti-Reflection coated screen

Supported Display Resolution

- **Computer formats**

Resolution	Refresh rate
Optimum 1920 x 1080	60 Hz

- **Video formats**

Resolution	Refresh rate
480i	60Hz
480p	60Hz
576i	50Hz
576p	50Hz
720p	50, 60Hz
1080i	50, 60Hz
1080p	24, 50, 60Hz

Sound

- Output power (RMS): 3W x 2
- Sound Enhancement: Incredible Surround, Smart Sound
- Sound System: Mono, Stereo, Nicam Stereo

Convenience

- Ease of Installation: Plug & Play, Automatic Tuning System (ATS)
- Ease of Use: On Screen Display, Program List, Side Control
- Remote control type: Philips Remote control
- On-Screen Display languages: Bulgarian, Croatian, Czech, Danish, Dutch, English, Estonian, Finnish, French, German, Greek, Hungarian, Italian, Kazakh, Latvian, Lithuanian, Norwegian, Portuguese, Polish, Romanian, Russian, Serbian, Slovak, Slovenian, Spanish, Swedish, Turkish, Ukraine
- Other convenience: VESA mount (75x75mm)
- Screen Format Adjustments: 4:3, Movie expand 14:9, Movie expand 16:9, Subtitle Zoom, Super Zoom, Wide Screen, Auto (WSS)
- SmartPicture: Personal, Vivid, Natural, Cinema, Game, Energy saving, Standard, Photo, Custom
- SmartSound: Personal, Standard, News, Cinema, Game, Drama, Sports
- Teletext: 1000 page Smart Text

Stand

- Tilt: 0/+15 degree

Tuner/Reception/ Transmission

- Aerial Input: 75 ohm coaxial (IEC75)
- TV system: PAL I, PAL B/G, PAL D/K, SECAM B/G, SECAM D/K, SECAM L/L'
- Video Playback: NTSC, PAL, SECAM
- Tuner Display: PLL
- CI/CI+: yes (Burn CI+ key in set)
- Digital TV: DVB-C, DVB-T
- MHEG-5 v1.06
- MPEG-2, MPEG-4 support
- Tuner bands: Hyperband, S-Channel, UHF, VHF

Connectivity

- Ext @ side: CI+, USB x 1 (Music/Photo/Video), Headphone x 1
- Ext @ rear: D-sub x 1, HDMI (1.4a) x 2, PC audio in x 1, Scart x 1, SPDIF out x 1 (RCA), Tuner x 1

Power

- On mode:
 - 221TE5: 27W (typ.) / 36W (max)
 - 241TE5: 31W (typ.) / 40W (max)
- Off mode: 0.3W (typ.)
- Standby mode: 0.3W (typ.)
- Ambient temperature: 5 °C to 40 °C
- Mains power: 100-240V, 50-60Hz

Dimensions

- Packaging in mm (WxHxD):
 - 221TE5: 565 x 434 x 116 mm
 - 241TE5: 606 x 464 x 117 mm
- Product with stand (mm):
 - 221TE5: 510.78 x 367.69 x 174.46 mm
 - 241TE5: 559.9 x 395.38 x 174.46 mm
- Product without stand (mm):
 - 221TE5: 510.78 x 316.86 x 74.36 mm
 - 241TE5: 559.9 x 346.5 x 75.71 mm

Weight

- Product with packaging (kg):
 - 221TE5: 4.85 kg
 - 241TE5: 5.36 kg
- Product with stand (kg):
 - 221TE5: 3.58 kg
 - 241TE5: 3.91 kg
- Product without stand (kg):
 - 221TE5: 3.35 kg
 - 241TE5: 3.57 kg

Accessories

- Included accessories: Power cord, Remote Control (with battery), Quick start guide, User Manual, VGA cable

Supported monitor mounts

To mount the monitor, purchase a Philips monitor mount or a VESA-compatible monitor mount. To prevent damage to cables and connectors, be sure to leave a clearance of at least 5.5 cm from the back of the monitor:



Warning

- Follow all instructions provided with the monitor mount. Koninklijke Philips Electronics N.V. bears no responsibility for improper monitor mounting that results in accident, injury or damage.

Monitor screen size (inches)	Required pitch (mm)	Required mounting bolts
21.5	75 x 75	4 x M4
23.6	75 x 75	4 x M4

7 TV/Channel installation

The first time you set up your TV, you are prompted to select a menu language and to install TV and digital radio channels (if available). Afterwards, you can re-install and fine tune channels.

Automatically install channels

You can search and store channels automatically.

Step 1: Select your menu language

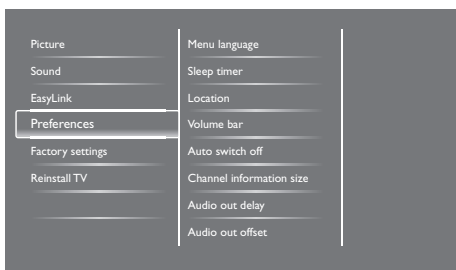

1. Press **↑**.
2. Select **[Setup] > [TV settings] > [Preferences] > [Menu language]**, then press **OK**.
3. Select a language, then press **OK**.

Step 2: Select your country

Select the country where you are installing the TV. The available channels for the country are installed on the TV.

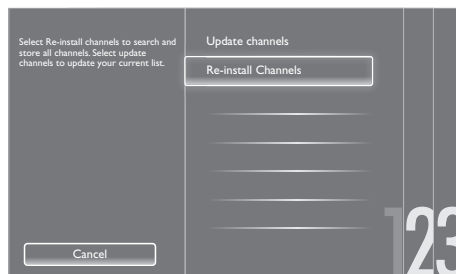

1. Press **↑**.
2. Select **[Setup] > [Search for channels]**, then press **OK**.
3. Select **[Reinstall channels]**, then press **OK**.
↳ The country menu appears.
4. Select your country, then press **OK**.
↳ The channel installation guide begins.
5. Select **[Start]**, then press **OK**.
↳ All available channels are stored.
6. To exit, press **OK**.

Update the channel list

You can enable automatic update of channels when your TV is in standby mode. The channels stored in your TV are updated every morning according to the channel information in the broadcast.

1. Press **↑**.
2. Select **[Setup] > [Channel settings] > [Channel installation] > [Automatic channel update]**.
3. Select **[On]** to enable the automatic update or select **[Off]** to disable it.
4. To return, press **↩**.

Manually install channels

This section describes how to search and store analogue TV channels manually.

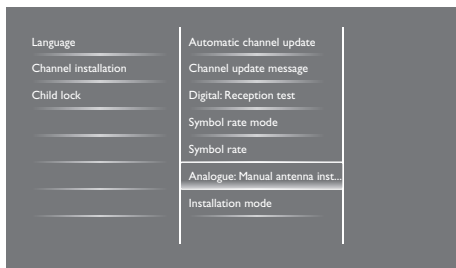

Step 1: Select your system



Note

- Skip this step if your system settings are correct.

1. Press **⬆**.
2. Select **[Setup] > [Channel settings] > [Channel installation] > [Analogue: Manual antenna installation] > [System]**, then press **OK**.
3. Select the correct system for your country or region, then press **OK**.

Step 2: Search and store new TV channels

1. Press **⬆**.
2. Select **[Setup] > [Channel settings] > [Channel installation] > [Analogue: Manual antenna installation] > [Find channel]**, then press **OK**.
 - If you know the three-digit frequency of the channel, enter it.
 - To search, select **[Search]**, then press **OK**.

3. When the channel is found, select **[Done]**, then press **OK**.
 - To store the channel as a new number, select **[Store as new channel]**, then press **OK**.
 - To store the channel as the previously selected channel, select **[Store current channel]**, then press **OK**.

Step 3: Fine-tune analogue channels

1. Press **⬆**.
2. Select **[Setup] > [Channel settings] > [Channel installation] > [Analogue: Manual antenna installation] > [Fine-tune]**, then press **OK**.
3. Press **▲▼** to fine-tune the channel.

Rename channels

You can rename channels. The name appears when you select the channel.

1. While you watch TV, press **OK**.
 - ↳ The channel matrix menu is displayed.
2. Select the channel to rename.
3. Press **☰** **OPTIONS**.
 - ↳ The channel options menu appears.
4. Select **[Rename channel]**, then press **OK**.
 - ↳ A text input box appears
5. Press **▲▼◀▶** to select each character, then press **OK**.
6. When the name is complete, select **[Done]**, then press **OK**.





Tip

- Press **[Aa]** to change an uppercase letter to a lowercase letter and vice versa.

Rearrange channels

After you install channels, you can rearrange the order in which they appear:

1. While you watch TV, press  **LIST** or **OK**.
↳ The channel matrix menu is displayed.
2. Press  **OPTIONS**.
↳ The channel options menu appears.
3. Select **[Reorder]**, then press **OK**.
4. Select the channel to rearrange, then press **OK**.
↳ The selected channel is highlighted.
5. Move the highlighted channel to its new location, then press **OK**.
6. Press  **OPTIONS**.
7. Select **[Done reordering]**, then press **OK**.

Test digital reception

You can check the quality and signal strength of digital channels. This allows you to reposition and test your antenna or satellite dish.

1. Press .
2. Select **[Setup] > [Channel settings] > [Channel installation] > [Digital: Reception test]**, then press **OK**.
3. Enter the frequency to test, then press **OK**.
4. Select **[Search]**, then press **OK**.
5. When the channel is found, select **[Store]**, then press **OK**.

Note

- If the signal quality and strength is poor, reposition the aerial or satellite dish and retest.
- If you still have problems with the reception of your digital broadcast, contact a specialised installer.

8 Settings

This chapter describes how to change settings and customize functions.

Access TV menus

Menus help you to install channels, change picture and sound settings and access other features.

1. Press **⏠**.
↳ The menu screen appears.

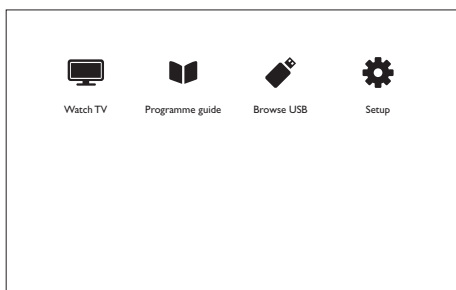

2. Select one of the following, then press **OK**.
 - **[Watch TV]**: If a source other than antenna is selected, switch back to the antenna source.
 - **[Programme guide]**: Access the electronic programme guide.
 - **[Browse USB]**: If a USB device is connected, access the content browser.
 - **[Setup]**: Access menus to change picture, sound and other settings.
3. Press **⏠** to exit.

Change picture and sound settings

Change picture and sound settings to suit your preferences. You can apply pre-defined settings or change settings manually.

Note

- While you watch TV or external devices, press **⏸ ADJUST**, then select **[Smart picture]** or **[Smart sound]** for quick access to picture and sound settings.

Manually adjust picture settings

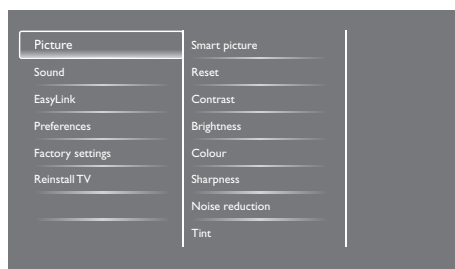

1. Press **⏠**.
2. Select **[Setup]** > **[TV settings]** > **[Picture]**, then press **OK**.
3. Select one of the following settings, then press **OK**.
 - **[Smart picture]**: Access predefined smart picture settings.
 - **[Reset]**: Reset to factory default settings.
 - **[Contrast]**: Adjust the intensity of backlight areas, while the video contents are kept unchanged.
 - **[Brightness]**: Adjust the intensity and details of dark areas.
 - **[Colour]**: Adjust colour saturation.
 - **[Sharpness]**: Adjust sharpness in the image.
 - **[Noise reduction]**: Filter and reduce noise in an image.

- **[Tint]:** Adjust the colour balance in an image.
- **[Custom tint]:** Customise tint setting. (Only available if **[Tint]** > **[Custom]** is selected)
- **[SmartVideo]:** Fine-tune each pixel to match surrounding pixels. This setting produces a brilliant, high-definition image.
 - **[Advanced sharpness]:** Enable superior picture sharpness.
 - **[SmartContrast]:** Enhance contrast. **[Medium]** setting is recommended.
 - **[Dynamic backlight]:** Adjust brightness of the TV backlight to match lighting conditions.
 - **[MPEG artifact reduction]:** Smooth out transitions on digital pictures. You can switch this feature on or off.
 - **[Colour enhancement]:** Make colours more vivid and improve the details in bright colours.
 - **[Gamma]:** Adjust the midtone intensity in the picture. Black and white are not affected.
- **[PC mode]:** Adjust the picture when a PC is connected to the TV via HDMI or DVI.
- **[Picture format]:** Change the picture format.
- **[Screen edges]:** Adjust the viewing area. (when set to maximum, you may see noise or the rough edge of an image).
- **[Picture shift]:** Adjust the picture position for all picture formats except for **[Auto zoom]** and **[Wide screen]**.

Change picture format

1. Press **III ADJUST**.
2. Select **[Picture format]**, then press **OK**.
3. Select a picture format, then press **OK**.

Summary of picture formats

The following picture settings can be configured.



Note

- Depending on the format of the picture source, some picture settings are not available.

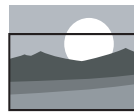

[Auto fill]: For selected models. Adjust the picture to fill the screen (subtitles remain visible). Recommended for minimal screen distortion but not for HD or PC.



[Auto zoom]: For selected models. Enlarge the picture to fill the screen. Recommended for minimal screen distortion but not for HD or PC.



[Super zoom]: (Not for HD and PC mode.) Remove the black bars on the side of 4:3 broadcasts. There is minimal distortion.



[4:3]: Show the classic 4:3 format.



[Unscaled]: For HD and PC mode only, and in selected models only. Allow maximum sharpness. Some distortion may be present due to the broadcaster's systems. Set your PC resolution to wide screen mode for best results.



[Subtitle zoom]: (Not for HD and PC mode.) Displays 4:3 pictures over the full area of the screen, with sub-titles visible. Part of the top of the picture is clipped off.



[Movie expand 14:9]: (Not for HD and PC mode.) Scale 4:3 format to 14:9.



[Movie expand 16:9]: (Not for HD and PC mode.) Scale 4:3 format to 16:9.



[Wide screen]: Scale 4:3 format to 16:9.

Manually adjust sound settings

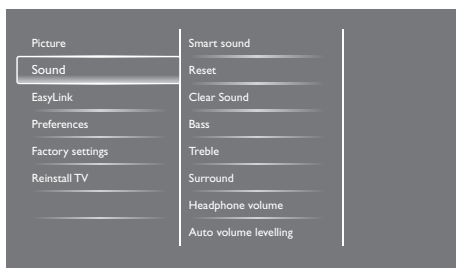

1. Press **⬆**.
2. Select **[Setup]** > **[TV settings]** > **[Sound]**, then press **OK**.
 ↳ The **[Sound]** menu appears.
3. Select one of the following settings, then press **OK**.
 - **[Smart sound]:** Access predefined smart sound settings.
 - **[Reset]:** Reset to factory default settings.
 - **[Clear Sound]:** Enhance the sound clarity.
 - **[Bass]:** Adjust the bass level.
 - **[Treble]:** Adjust the treble level.

- **[Surround]:** Switch on spatial sound.
- **[Headphone volume]:** (For models with headphones) Adjust headphone volume.
- **[Auto volume levelling]:** Automatically reduce sudden volume changes, for example when switching channels.
- **[Balance]:** Adjust the balance of the right and left speakers.
- **[Digital output format]:** Select the type of digital audio output through digital audio output connector.
 - **[PCM]:** Convert non-PCM audio type to PCM format.
 - **[Multichannel]:** Output audio to the home theatre.

Use the universal access menu

You can switch on or off visually impaired and hearing impaired options for enhanced visual or audio cues.

1. While you watch TV, press **⬆**.
2. Select **[Setup]** > **[Channel settings]** > **[Languages]**.
3. Select one of the following options, then press **OK**.
 - **[Primary audio language]:** If the selected audio language is broadcasting, it is set to default language.
 - **[Secondary audio language]:** If the primary audio language is not broadcasting, the secondary audio will be displayed.
 - **[Primary subtitle language]:** If the selected subtitle is broadcasting, it is selected by default.
 - **[Secondary subtitle language]:** If the primary subtitle is not broadcasting, the secondary subtitle will be displayed.

- **[Primary Teletext]:** If the selected teletext is broadcasting, it is selected by default.
 - **[Secondary Teletext]:** If the primary teletext is not broadcasting, the secondary teletext will be displayed.
 - **[Hearing impaired]:** Enable or disable hearing impaired subtitles.
 - **[Visually impaired]:** Some digital TV channels broadcast special audio adapted for people who are visually impaired. The normal audio is mixed with extra commentary. Select an option:
 - **[Off]:** Turn off visually impaired audio.
 - **[Speakers]:** Hear visually impaired audio from speakers only
 - **[Headphone]:** Hear visually impaired audio from headphones only.
 - **[Speaker + headphone]:** Hear visually impaired audio from both speakers and headphone.
 - **[Volume visually impaired]:** Adjust the volume of visually impaired audio.
 - **[Preferred audio format]:** Set the preferred audio format.
4. To exit, press **↵**.

Use advanced teletext features

Access the teletext options menu

Access the teletext features through the teletext options menu.

1. Press **TEXT**.
 - ↳ The teletext screen appears.
2. Press **☰ OPTIONS**.
 - ↳ The teletext options menu appears.
3. Select one of the following options, then press **OK**.
 - **[Freeze page] / [Unfreeze page]:** Freeze/unfreeze the current page.
 - **[Dual screen] / [Full screen]:** Switch between full screen and dual screen teletext.
 - **[T.O.P. overview]:** Switch on Table of Pages teletext broadcasts
 - **[Enlarge] / [Normal view]:** Switch between enlarged and normal view of teletext pages.
 - **[Reveal]:** Hide or reveal hidden information on a page, such as solutions to riddles or puzzles.
 - **[Cycle subpages]:** If subpages are available, automatically display each subpage in sequence.

Select teletext subpages

A teletext page can contain several subpages. Subpages are displayed next to the main page number.

1. Press **TEXT**.
 - ↳ The teletext screen appears.
2. Press **◀** or **▶** to select a teletext page.
3. Press **◀** or **▶** to enter a subpage.

Select T.O.P. teletext broadcasts



Jump from one subject to another without entering page numbers with Table Of Pages (T.O.P.) teletext broadcasts. T.O.P. teletext broadcasts are available on selected TV channels.

1. Press **TEXT**.
 - ↳ The teletext screen appears.
2. Press  **OPTIONS**.
3. Select **[T.O.P. overview]**, then press **OK**.
 - ↳ The T.O.P. overview appears.
4. Select a subject.
5. Press **OK** to view the page.

Create and use lists of favourite channels

You can create a list of your preferred TV channels so that you can find those channels easily.

View only the list of favourite channels



1. While you watch TV, press  **LIST** or **OK**.
 - ↳ The channel matrix menu is displayed.
2. Press  **OPTIONS**.
3. Select **[Select list] > [Favourite]**, then press **OK**.
 - ↳ Only channels in the favourites list appear in the channel grid.

Note

- The favourites channel grid is empty until you add channels into the favourites list.

View all channels



You can exit the favourites list, and view all installed channels.

1. While you watch TV, press  **LIST** or **OK**.
 - ↳ The channel matrix menu is displayed.
2. Press  **OPTIONS**.
3. Select **[Select list] > [All]**, then press **OK**.
 - ↳ All channels are displayed in the channel grid.

Note

- All favourite channels are marked by an asterisk when you view the channel grid.

Manage the favourites list

1. While you watch TV, press  **LIST** or **OK**.
 - ↳ The channel matrix menu appears.
2. Press  **OPTIONS**.
3. Select **[Select list] > [All]**, then press **OK**.
4. Press  **OPTIONS**.
5. Select **[Mark as favourite]** or **[Unmark as favourite]**, then press **OK**.
 - ↳ The channel is added or removed from the favourite list.

Note

- All favourite channels are marked by an asterisk in the channel grid.

Use the Electronic Programme Guide

The programme guide is an on-screen guide available for digital channels. It allows you to:

- View a list of digital programmes being broadcast
- View upcoming programmes
- Group programmes by genre
- Set reminders when programmes start
- Setup preferred programme guide channels

Switch on EPG

1. Press **⬆**.
2. Select **[Programme guide]**, then press **OK**.
 - ↳ The programme guide appears displaying information about the scheduled programmes.

Note

- Programme guide data is available only in selected countries and can take some time to load.

Change programme guide options

You can set or clear reminders, change the day, and access other useful options in the programme guide options menu

1. Press **⬆**.
2. Select **[Programme guide]**, then press **OK**.
3. Press **☰** **OPTIONS**.
 - ↳ The programme guide menu appears.
4. Select one of the following options, then press **OK**.
 - **[Set reminder] / [Clear reminders]**: Set or clear programme reminders.
 - **[Change day]**: Set the programme guide day.

- **[More info]**: Display programme information.
- **[Search by genre]**: Search TV programmes by genre.
- **[Scheduled reminders]**: List programme reminders. Only available for upcoming programmes.
- **[Update Guide data]**: Update the latest programme guide information.

Display the TV clock

You can display a clock on the TV screen. The clock displays the current time using time data received from your TV service operator.

Set the TV clock manually

In some countries, you need to set TV clock manually.

1. Press **⬆**.
2. Select **[Setup] > [TV settings] > [Preferences] > [Clock]**.
3. Select **[Auto clock]**, then press **OK**.
4. Select **[Manual]**, then press **OK**.
5. Select **[Time]** or **[Date]**, then press **OK**.
6. Press the **Navigation buttons** to set the time or date.
7. Select **[Done]**, then press **OK**.
8. Press **⬆** to exit.

Note

- If your selected country supports digital broadcast, the clock displays the time data from your TV service operator as priority.

Display the TV clock

1. While you watch TV, press  **OPTIONS**.
↳ The options menu is displayed.
2. Select **[Clock]**.
3. Press **OK**.

Note

- To disable the clock, repeat the procedure.

Change the clock mode

1. Press .
2. Select **[Setup] > [TV settings] > [Preferences] > [Clock] > [Auto clock]**.
3. Select **[Automatic]** or **[Manual]**, then press **OK**.

Set the time zone

Note

- This option is only available in Spain & Portugal.

1. Press .
2. Select **[Setup] > [TV settings] > [Preferences] > [Clock] > [Auto clock] > [Manual]**, then press **OK**.
3. Select **[Time zone]**, then press **OK**.
4. Select your time zone, then press **OK**.

Use daylight saving

Note

- This option is only available if you select **[Auto clock] > [Manual]**.

1. Press .
2. Select **[Setup] > [TV settings] > [Preferences] > [Clock] > [Auto clock] > [Manual]**, then press **OK**.
3. Select **[Daylight savings]**, then press **OK**.
4. Select **[Standard]** or **[Daylight saving time]**, then press **OK**.

Use timers

You can set timers to switch the TV to standby at a specified time.

Tip

- Set the TV clock before you use timers.

Automatically switch the TV to standby (sleep timer)

Sleep timer switches the TV to standby after a pre-defined duration.

Tip

- You can switch off your TV earlier or reset the sleep timer during the countdown.

1. Press .
2. Select **[Setup] > [TV settings] > [Preferences] > [Sleep timer]**.
↳ The **[Sleep timer]** menu appears.
3. Select a value.
↳ If you select zero, the sleep timer switches off.
4. Press **OK** to switch on the sleep timer.
↳ The TV switches to standby after the specified time.

Lock unsuitable content

You can prevent your children from watching certain programmes or channels by locking the TV controls.

Set or change code

1. Press **⬆**.
2. Select **[Setup] > [Channel settings] > [Child lock]**.
3. Select **[Set code]** or **[Change code]**.
↳ The **[Set code]** / **[Change code]** menu appears.
4. Enter your code using the **Numeric buttons**.
↳ Follow the on-screen instructions to create or change your PIN code.



Tip

- If you forget your code, enter '8888' to override any existing codes.

Lock or unlock one or more channels

1. Press **⬆** > **[Setup]** > **[Channel settings]** > **[Child lock]** > **[Channel lock]**.
↳ A list of channels is displayed.
2. Select the channel that you want to lock or unlock, then press **OK**.
↳ The first time you lock or unlock a channel, you are prompted to enter your PIN code.
3. Enter your code and press **OK**.
↳ If the channel is locked, a lock icon is displayed.
4. Repeat the process to lock or unlock more channels.

5. To activate the locks, switch the TV on and off.
↳ When you access the locked channels from the channel grid, you are prompted to enter your PIN code.

Set parental ratings

Some digital broadcasters rate their programmes according to age. You can set your TV to display only programmes with age ratings lower than your child's age.

1. Press **⬆**.
2. Select **[Setup] > [Channel settings] > [Child lock] > [Parental rating]**.
↳ A code setup screen appears.
3. Enter your code using **Numeric buttons**.
↳ The rating menu appears.
4. Select an age rating, then press **OK**.
5. Press **⬆** to exit.

Change language

Depending on your broadcaster, you can change the audio language, subtitle language, or both, for a TV channel.

Multiple audio languages, subtitles, or both, are broadcast through teletext or DVB-T digital broadcasts. Dual sound broadcasts: With digital broadcasts, you can select a subtitle language.

Change menu language

1. Press **⬆**.
2. Select **[Setup] > [TV settings] > [Preferences] > [Menu language]**, then press **OK**.
3. Select a language, then press **OK**.

Change audio language

You can choose an audio language if it is available from your broadcaster. For digital channels, multiple languages may be available. For analogue channels, two languages may be available.

1. While you watch TV, press  **OPTIONS**.
2. For digital channels, select **[Audio language]**, select the language, then press **OK**.
3. For analogue channels, select **[Dual I-II]**, select either language, then press **OK**.

Show or hide subtitles

1. While you watch TV, press **SUBTITLE**.
2. Select one of the following, then press **OK**.
 - **[Off]**: Never display subtitles.
 - **[On]**: Always display subtitles.
 - **[On during mute]**: When audio is muted, display subtitles.



Note

- Repeat this procedure to enable subtitles on each analogue channel.
- Select **[Subtitles]** > **[Off]** to disable subtitles.

Select a subtitle language in digital channels



Note

- When you select a subtitle language in a digital TV channel as described below, the preferred subtitle language set in the installation menu is temporarily overruled.

1. While you watch TV, press  **OPTIONS**.
2. Select **[Subtitle language]**, then press **OK**.
3. Select a subtitle language.
4. Press **OK** to confirm.

Update the TV software

Philips continuously tries to improve its products and we recommend that you update the TV software when updates are available.

Ways to update the TV software

You can update the TV software in one of the following ways:



- A: with a USB storage device, or
B: after being prompted through digital broadcasts.

A: with a USB storage device,

To update with a USB storage device, you need:

- A computer with Internet access
- A USB storage device.

Step 1: Check the current software version

1. Press .
2. Select **[Setup]** > **[Software settings]** > **[Current software info]**.
 - ↳ The current software information is displayed.
3. Write down the software version number.
4. To return, press **OK**.
5. To exit, press .

Step 2: Download and update the latest software version

1. Connect a USB storage device.
2. Press .
3. Select **[Setup]** > **[Update software]**.
4. Follow the instructions to load a file onto your USB storage device.

5. Connect the USB storage device to your computer, then double-click the file.
↳ A Web page is launched.
6. Follow the instructions in the Web page.
 - If the current software version matches the latest software update file, you do not need to update your TV software.
 - If the current software version is smaller than the latest software update file, download the latest software update file to the root directory of your USB device.
7. Disconnect the USB storage device from the computer.

B: Check for updates through digital broadcasts

You can check if there are updates available through digital broadcasts.

1. Press **▲**.
2. Select **[Setup] > [Software settings] > [Check for major updates]**.
3. If an update is available, follow the on-screen instructions to start the update.
↳ The TV restarts after the software update is complete.

Change TV preferences

Use the preferences menu to customise your TV settings.

1. Press **▲**.
2. Select **[Setup] > [TV settings] > [Preferences]**.
3. Select one of the following, then press **OK**.
 - **[Menu language]**: Select a menu language.
 - **[Sleep timer]**: Switch the TV to standby after a pre-defined duration.
 - **[Location]**: Optimise TV settings for your location - home or shop.
 - **[E-sticker]**: This item set the TV to Shop mode. When any other OSD on screen, E-Sticker would not come out.
 - **[Volume bar]**: Display the volume bar when you adjust the volume.
 - **[Auto switch off]**: To conserve energy, set the TV to switch off automatically after a period of inactivity.
 - **[Channel information size]**: Change the type of information that is displayed when you switch channels.
 - **[Audio out delay]**: Automatically sync the image on your TV to the audio from a connected Home Theatre.
 - **[Audio out offset]**: Adjust the audio out offset.
 - **[Teletext 2.5]**: With Teletext 2.5, you can view text with more colours and better graphics than normal text.
 - **[Clock]**: Display or remove the time from the TV, and set clock options.

Start a TV demo

You can use demonstrations to better understand the features of your TV. Some demos are not available on certain models. Available demos are displayed in the menu list.

1. While you watch TV, press **⬆**.
2. Select **[Setup] > [Watch demo], OK**.
3. Select a demo and press **OK** to view it.
4. To exit, press **⬅**.

Reset the TV to factory settings

You can restore the default picture and sound settings of your TV. The channel installation settings remain the same.

1. Press **⬆**.
2. Select **[Setup] > [TV settings] > [Factory settings]**, then press **OK**.
3. If you are prompted to enter a code, enter the child-lock code (see 'Set or change code' on page 26).
↳ A confirmation message is displayed.
4. Press **OK** to confirm.

9 Multimedia

This chapter describes how to use the multimedia function.

Play photos, music, and video on USB storage devices

Supported video formats on the USB device:

- Supported storage device: USB (only FAT or FAT 32 USB storage devices are supported.)
- Compatible multimedia file formats:
 - Image: JPEG (*.jpg), PNG
 - Audio: MPEG1 (*.mp3)
 - Video: *.avi, *.mp4, *.mov, *.mkv, *.mpg, *.mpeg

Connect a USB storage device to play photos, music, or video stored on it.



1. Switch on the TV.
2. Connect the USB device to the USB port on the side of your TV.
3. Press .
4. Select **[Browse USB]**, then press **OK**.
 - ↳ The USB browser appears.









Caution

- Philips is not responsible if the USB storage device is not supported, nor is it responsible for damage or loss of data from the device.



View photos

1. In the USB browser, select **[Picture]**, then press **OK**.
2. Select a photo or a photo album, then press **OK** to view the photo enlarged to fill the TV screen.
 - To view the next or previous photo, press  .
3. To return, press .

View a slide show of your photos

1. When a full screen image of a photo is displayed, press **OK**.
 - ↳ A slide show begins from the selected photo.
 - Press the following buttons to control play:
 -  to play.
 -  to pause.
 -  or  to play the previous or next photo.
 -  to stop.
 - To return, press .

Change slide show settings

1. While you view a slide show, press  **OPTIONS**.
 - ↳ The slide show options menu is displayed.
2. Select one of the following, then press **OK**.
 - **[Start/Stop slideshow]**: Start or stop slideshow.
 - **[Slideshow transitions]**: Set the transition from one picture to the next.
 - **[Slideshow frequency]**: Select the display time for each photo.
 - **[Repeat]** / **[Play once]**: View the pictures in the folder once only, or repeatedly.
 - **[Shuffle off]** / **[Shuffle on]**: View the pictures in sequential order, or at random.
 - **[Rotate image]**: Rotate photo.
 - **[Show info]**: Display the picture name, date, size and next picture in the slide show.
3. To return, press .



Note

- **[Rotate image]** and **[Show info]** appear only when the slideshow is paused.

Listen to music

1. In the USB browser, select **[Music]**, then press **OK**.
2. Select a music track or album, then press **OK** to play.
3. To control play, press the play buttons:
 - **▶** to play.
 - **⏸** to pause.
 - **◀** or **▶** to play the previous or next track.
 - **⏮** or **⏭** to search forward or backward.
 - **■** to stop.

Change music settings

- While you play music, press **☰** **OPTIONS** to access one of the following settings, then press **OK**.
 - **[Stop playback]**: Stop music play.
 - **[Repeat]**: Play a song once or repeatedly.
 - **[Shuffle on]** / **[Shuffle off]**: Play songs in sequence or at random.
 - **[Show info]**: Display the file name.

View a slideshow with music

You can view a picture slide show with background music.

1. Select an album of songs.
2. Press **OK**.
3. Press **↵** to return to the USB content browser.
4. Select an album of pictures.
5. Press **OK**.
 - ↳ The slideshow begins.
6. To exit, press **↵**.

Play video

1. In the USB browser, select **[Video]**, then press **OK**.
2. Select a video file, then press **OK** to play.
3. To control play, press the play buttons:
 - **▶** to play.
 - **⏸** to pause.
 - **◀** or **▶** to play the previous or next video.
 - **⏮** or **⏭** to search forward or backward.
 - **■** to stop.

Change video settings

- While you play video, press **☰** **OPTIONS** to access one of the following settings, then press **OK**.
 - **[Stop playback]**: Stop video play.
 - **[Show info]**: Display the file name.

Disconnect a USB storage device



Caution

- Follow this procedure to avoid damage to your USB storage device.

1. Press **↵** to exit the USB browser.
2. Wait for five seconds, then disconnect the USB storage device.

Listen to digital radio channels

1. Press **☰** **LIST**.
 - ↳ The channel matrix menu is displayed.
2. Press **☰** **OPTIONS**, then select **[Select list]** > **[Radio]**.
 - ↳ The radio channel grid appears.
3. Select a radio channel and press **OK** to listen.

10 Pixel policy

Philips strives to deliver the highest quality products. We use some of the industry's most advanced manufacturing processes and practice stringent quality control. However, pixel or sub pixel defects on a flat monitor panel are sometimes unavoidable. No manufacturer can guarantee that all panels will be free from pixel defects, but Philips guarantees that any monitor with an unacceptable number of defects will be repaired or replaced under warranty. This notice explains the different types of pixel defects and defines acceptable defect levels for each type. In order to qualify for repair or replacement under warranty, the number of pixel defects on a monitor panel must exceed these acceptable levels. For example, no more than 0.0004% of the sub pixels on a monitor may be defective. Furthermore, Philips sets even higher quality standards for certain types or combinations of pixel defects that are more noticeable than others. This policy is valid worldwide.

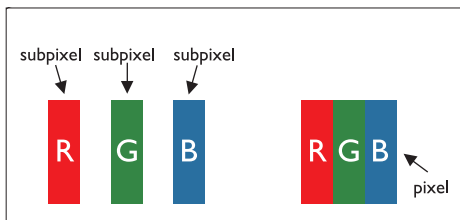

Pixels and Sub pixels

A pixel, or picture element, is composed of three sub pixels in the primary colors of red, green and blue. Many pixels together form an image. When all sub pixels of a pixel are lit, the three colored sub pixels together appear as a single white pixel. When all are dark, the three colored sub pixels together appear as a single black pixel. Other combinations of lit and dark sub pixels appear as single pixels of other colors.

Types of Pixel Defects

Pixel and sub pixel defects appear on the screen in different ways. There are two categories of pixel defects and several types of sub pixel defects within each category.

Bright Dot Defects: bright dot defects appear as pixels or sub pixels that are always lit or 'on'. That is, a bright dot is a sub-pixel that stands out on the screen when the monitor displays a dark pattern.

These are some types of bright dot defects:

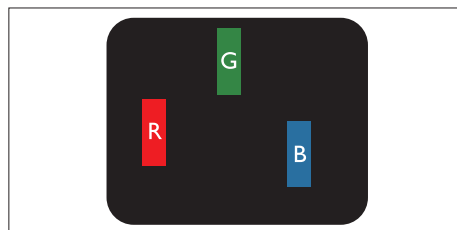

One lit red, green or blue sub pixel

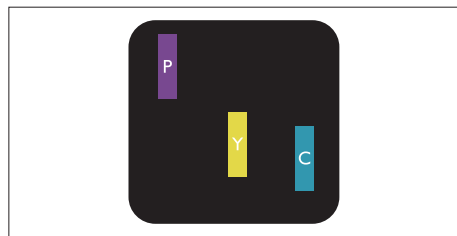

Two adjacent lit sub pixels:

- Red + Blue = Purple
- Red + Green = Yellow
- Green + Blue = Cyan (Light Blue)

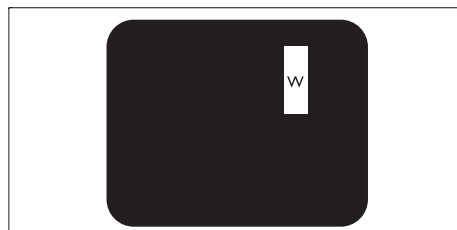

Three adjacent lit sub pixels (one white pixel)

Note

- A red or blue bright dot must be more than 50 percent brighter than neighboring dots while a green bright dot is 30 percent brighter than neighboring dots.

Black Dot Defects: black dot defects appear as pixels or sub pixels that are always dark or 'off'. That is, a dark dot is a sub-pixel that stands out on the screen when the monitor displays a light pattern.

These are some types of black dot defects:

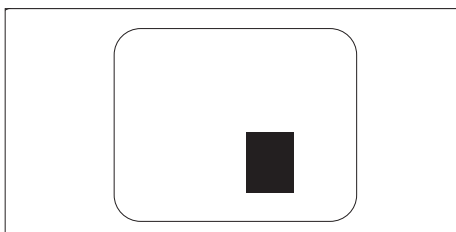
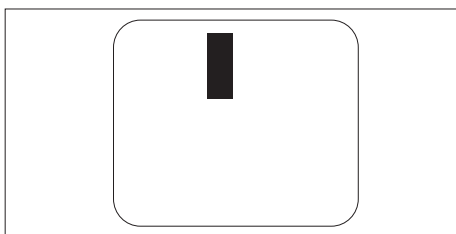

Proximity of Pixel Defects

Because pixel and sub pixels defects of the same type that are near to one another may be more noticeable, Philips also specifies tolerances for the proximity of pixel defects.

Pixel Defect Tolerances

In order to qualify for repair or replacement due to pixel defects during the warranty period, a Philips flat monitor panel must have pixel or sub pixel defects exceeding the tolerances listed in the following tables.

BRIGHT DOT DEFECTS	ACCEPTABLE LEVEL
MODEL	221TE5 / 241TE5
1 lit subpixel	3
2 adjacent lit subpixels	1
3 adjacent lit subpixels (one white pixel)	0
Distance between two bright dot defects*	>15mm
Total bright dot defects of all types	3

BLACK DOT DEFECTS	ACCEPTABLE LEVEL
MODEL	221TE5 / 241TE5
1 dark subpixel	5 or fewer
2 adjacent dark subpixels	2 or fewer
3 adjacent dark subpixels	0
Distance between two black dot defects*	>15mm
Total black dot defects of all types	5 or fewer

TOTAL DOT DEFECTS	ACCEPTABLE LEVEL
MODEL	221TE5 / 241TE5
Total bright or black dot defects of all types	5 or fewer



Note

- 1 or 2 adjacent sub pixel defects = 1 dot defect

11 Troubleshooting

This section describes commonly encountered issues and suggested solutions.

General monitor issues

The monitor does not switch on:

- Disconnect the power cable from the power outlet. Wait for one minute then reconnect it.
- Check that the power cable is securely connected.

The remote control is not working properly:

- Check that the remote control batteries are correctly inserted according to the +/- orientation.
- Replace the remote control batteries if they are flat or weak.
- Clean the remote control and monitor sensor lens.

The monitor menu is in the wrong language

- Change the monitor menu to your preferred language.

When turning the monitor on/off/to standby, you hear a creaking sound from the monitor chassis:

- No action is required. The creaking sound is normal expansion and contraction of the monitor as it cools and warms up. This does not impact performance.

TV channel issues

Previously installed channels do not appear in the channel list:

- Check that the correct channel list is selected.

No digital channels were found during the installation:

- Check that the monitor supports DVB-T or BVD-C in your country. See the listed countries on the back of the monitor.

Picture issues

The monitor is on, but there is no picture:

- Check that the antenna is properly connected to the monitor.
- Check that the correct device is selected as the monitor source.

There is sound but no picture:

- Check that the picture settings are correctly set.

There is poor monitor reception from an antenna connection:

- Check that the antenna is properly connected to the monitor.
- Loud speakers, unearthed audio devices, neon lights, high buildings and other large objects can influence reception quality. If possible, try to improve the reception quality by changing the antenna direction or moving devices away from the monitor.
- If reception on only one channel is poor, fine tune this channel.

There is poor picture quality from connected devices:

- Check that the devices are connected properly.
- Check that the picture settings are correctly set.

The monitor did not save your picture settings:

- Check that the monitor location is set to the home setting. This mode offers you the flexibility to change and save settings.

The picture does not fit the screen; it is too big or too small:

- Try a different picture format.

The picture position is incorrect:

- Picture signals from some devices may not fit the screen correctly. Check the signal output of the device.

Sound issues

There is a picture but no sound from the monitor:

Note

- If no audio signal is detected, the monitor automatically switches the audio output off — this does not indicate malfunction.

- Check that all cables are properly connected.
- Check that the volume is not set to 0.
- Check that the sound is not muted.

There is a picture but the sound quality is poor:

- Check that the sound settings are correctly set.

There is a picture but sound comes from one speaker only:

- Verify that sound balance is set to the center.

HDMI connection issues

There are problems with HDMI devices:

- Note that HDCP support can delay the time taken for a monitor to display content from an HDMI device.
- If the monitor does not recognise the HDMI device and no picture is displayed, try switching the source from one device to another and back again.
- If there are intermittent sound disruptions, check that output settings from the HDMI device are correct.
- If an HDMI-to-DVI adaptor or HDMI to DVI cable is used, check that an additional audio cable is possible could be connected to **PC AUDIO IN** (mini-jack only).

Computer connection issues

The computer display on the monitor is not stable:

- Check that a supported resolution and refresh rate is selected on the computer.
- Set the monitor picture format to unscaled.

Contact us

If you cannot resolve your problem, refer to the FAQs for this monitor at www.philips.com/support.

If the problem remains unresolved, contact Philips Consumer Care in your country as listed in this User Manual.



Warning

- Do not attempt to repair the monitor yourself. This may cause severe injury, irreparable damage to your monitor or void your warranty.



Note

- Make a note of your monitor model and serial number before you contact Philips. These numbers are printed on the back of the monitor and on the packaging.



Version: M5241TEEIT

2013 © Koninklijke Philips Electronics N.V. All rights reserved.

Specifications are subject to change without notice.

Philips and the Philips Shield Emblem are registered trademarks of Koninklijke Philips Electronics N.V. and are used under license from Koninklijke Philips Electronics N.V.

www.philips.com