

User manual

S19E200BR
S19E200BW
S19E200NW
S19E200NY
S19E450BR
S19E450BW
S19E450MR
S19E450MW
S22E200B
S22E200BW
S22E200N
S22E200NY
S22E450B
S22E450BW
S22E450D
S22E450DW
S22E450M
S22E450MW
S23E200B
S23E450B
S24E200BL
S24E450B
S24E450BL
S24E450D
S24E450DL
S24E450M
S24E650BW
S27E450B
S27E450D

The color and the appearance may differ depending on the product, and the specifications are subject to change without prior notice to improve the performance.

Table Of Contents

BEFORE USING THE PRODUCT	8	Copyright
	8	Icons used in this manual
	9	Cleaning
	10	Securing the Installation Space
	10	Precautions for storage
	11	Safety Precautions
	11	Symbols
	12	Electricity and Safety
	13	Installation and Safety
	15	Operation and Safety
	19	Correct posture to use the product
PREPARATIONS	20	Checking the Components
	20	Checking the Components
	22	Parts
	22	Frontal Buttons (SE200 Series)
	24	Frontal Buttons (S**E450B*, S**E650B*)
	26	Frontal Buttons (S**E450M*)
	28	Frontal Buttons (S**E450D*)
	30	Reverse Side (SE200 Series)
	31	Reverse Side (S**E450B*, S**E650B*)
	32	Reverse Side (S**E450M*)
	33	Reverse Side (S**E450D*)
	34	Right Side View (S**E450D*)
	35	Installation
	35	Attaching the Stand (SE200 Series)
	36	Attaching the Stand (SE450, SE650 Series)
	37	Removing the Stand (SE200 Series)
	38	Adjusting the Product Tilt (SE200 Series)
	39	Adjusting the Product Tilt and Height (SE450, SE650 Series)
	40	Rotating the Monitor (SE450, SE650 Series)
	41	Installing a Wall-mount Kit or Desktop Stand
	44	Anti-theft Lock

Table Of Contents

CONNECTING AND USING A SOURCE DEVICE	45	Before Connecting
	45	Pre-connection Checkpoints
	46	Connecting and Using a PC
	46	Connecting to a PC
	51	Connecting the Power
	55	Driver Installation
	56	Setting Optimum Resolution
SCREEN SETUP	57	Brightness
	57	Configuring Brightness
	58	Contrast
	58	Configuring Contrast
	59	Sharpness
	59	Configuring Sharpness
	60	Eye Saver Mode
	60	Configuring Eye Saver Mode
	61	Game Mode
	61	Configuring Game Mode
	62	SAMSUNG MAGIC Bright
	62	Configuring SAMSUNG MAGIC Bright
	63	SAMSUNG MAGIC Angle (Except S19E200NY / S22E200NY / S24E650BW)
	63	Configuring SAMSUNG MAGIC Angle
	65	SAMSUNG MAGIC Upscale
	65	Configuring SAMSUNG MAGIC Upscale
	66	Image Size (Except S19E200BR / S19E450BR / S19E450MR)
	66	Changing the Image Size
	68	Response Time (S24E650BW)
	68	Configuring the Response Time

Table Of Contents

	69	H-Position & V-Position
	69	Configuring H-Position & V-Position
	70	Coarse
	70	Adjusting Coarse
	71	Fine
	71	Adjusting Fine
CONFIGURING TINT	72	Red
	72	Configuring Red
	73	Green
	73	Configuring Green
	74	Blue
	74	Configuring Blue
	75	Color Tone
	75	Configuring the Color Tone Settings
	76	Gamma
	76	Configuring Gamma
RESIZING OR RELOCATING THE SCREEN	77	Language
	77	Changing the Language
	78	Menu H-Position & Menu V-Position
	78	Configuring Menu H-Position & Menu V-Position
	79	Display Time
	79	Configuring Display Time
	80	Transparency
	80	Changing Transparency
SETUP AND RESET	81	Reset All
	81	Initializing Settings (Reset All)

Table Of Contents

	82	Smart Eco Saving
	82	Configuring Smart Eco Saving
	83	Off Timer (S19E200NW / S19E200NY / S22E200N /S22E200NY)
	83	Configuring Off Timer
	84	Configuring Turn Off After
	85	Off Timer Plus (Except S19E200NW / S19E200NY / S22E200N / S22E200NY)
	85	Configuring Off Timer
	87	Configuring Eco Timer
	89	PC/AV Mode (Except S19E200NW / S19E200NY / S22E200N / S22E200NY)
	89	Configuring PC/AV Mode
	91	Key Repeat Time
	91	Configuring Key Repeat Time
	92	Source Detection (Except S19E200NW / S19E200NY / S22E200N / S22E200NY)
	92	Configuring Source Detection
INFORMATION MENU AND OTHERS	93	INFORMATION
	93	Displaying INFORMATION
	94	Configuring Brightness, Contrast and Sharpness from the Initial Screen
	95	Configuring Volume in the Initial Screen
INSTALLING THE SOFTWARE	96	MultiScreen
	96	Installing the Software
	97	Removing the Software

Table Of Contents

TROUBLESHOOTING GUIDE	98	Requirements Before Contacting Samsung Customer Service Center
	98	Testing the Product
	98	Checking the Resolution and Frequency
	98	Check the following.
	101	Q & A
SPECIFICATIONS	103	General (S19E200NY / S19E200NW)
	105	General (S19E200BW / S19E200BR)
	107	General (S22E200NY)
	108	General (S22E200B / S22E200N / S22E200BW)
	110	General (S23E200B / S24E200BL)
	112	General (S19E450BW / S19E450MW / S19E450BR / S19E450MR)
	114	General (S22E450B / S22E450M / S22E450D)
	116	General (S22E450BW / S22E450MW / S22E450DW)
	118	General (S23E450B)
	120	General (S24E450BL / S24E450DL)
	122	General (S24E450B / S24E450M / S24E450D)
	124	General (S24E650BW)
	126	General (S27E450B / S27E450D)
	128	PowerSaver
	132	Standard Signal Mode Table

Table Of Contents

APPENDIX	140	Responsibility for the Pay Service (Cost to Customers)
	140	Not a product defect
	140	A Product damage caused by customer's fault
	140	Others
	142	Correct Disposal
	142	Correct Disposal of This Product (Waste Electrical & Electronic Equipment)
	142	Extended warranty
	143	Terminology

INDEX

Before Using the Product

Copyright

The contents of this manual are subject to change without notice to improve quality.

© 2015 Samsung Electronics

Samsung Electronics owns the copyright for this manual.

Use or reproduction of this manual in parts or entirety without the authorization of Samsung Electronics is prohibited.

Microsoft, Windows and Windows NT are registered trademarks of Microsoft Corporation.

VESA, DPM and DDC are registered trademarks of the Video Electronics Standards Association.

- An administration fee may be charged if either
 - (a) an engineer is called out at your request and there is no defect in the product (i.e. where you have failed to read this user manual).
 - (b) you bring the unit to a repair center and there is no defect in the product (i.e. where you have failed to read this user manual).
- The amount of such administration charge will be advised to you before any work or home visit is carried out.

Icons used in this manual



The following images are for reference only. Real-life situations may differ from what is shown in the images.

Before Using the Product

Cleaning

Exercise care when cleaning as the panel and exterior of advanced LCDs are easily scratched.

Take the following steps when cleaning.

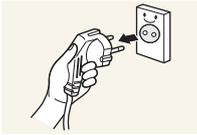

1. Power off the monitor and computer.
2. Disconnect the power cord from the monitor.



Hold the power cable by the plug and do not touch the cable with wet hands. Otherwise, an electric shock may result.

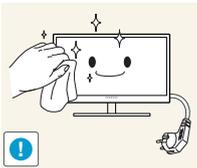

3. Wipe the monitor screen using a clean, soft and dry cloth.



- Do not apply a cleaning agent that contains alcohol, solvent, or surfactant to the monitor.



- Do not spray water or detergent directly on the product.

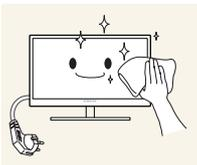

4. Wet a soft and dry cloth in water and wring thoroughly to clean the exterior of the monitor.

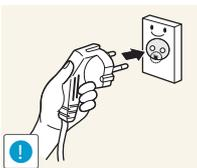

5. Connect the power cord to the product after cleaning the product.
6. Power on the monitor and computer.

Before Using the Product

Securing the Installation Space

- Ensure some space around the product for ventilation. An internal temperature rise may cause fire and damage the product. Be sure to allow the amount of space as shown below or greater when installing the product.



The exterior may differ depending on the product.

SE200 Series

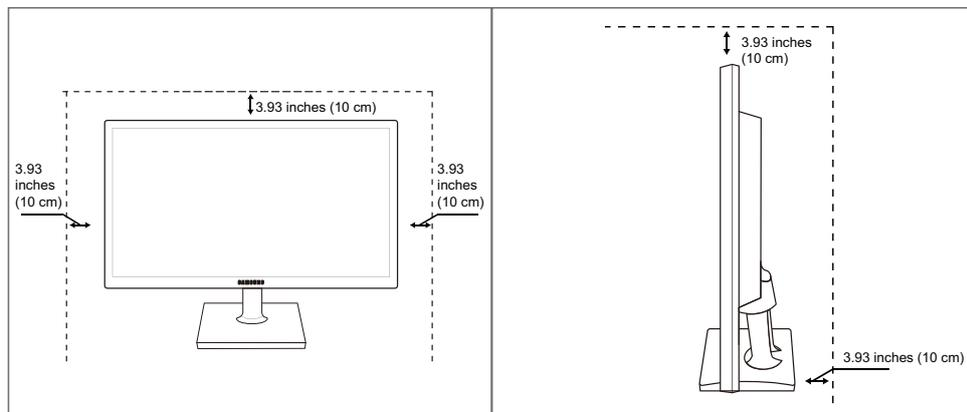

SE450, SE650 Series

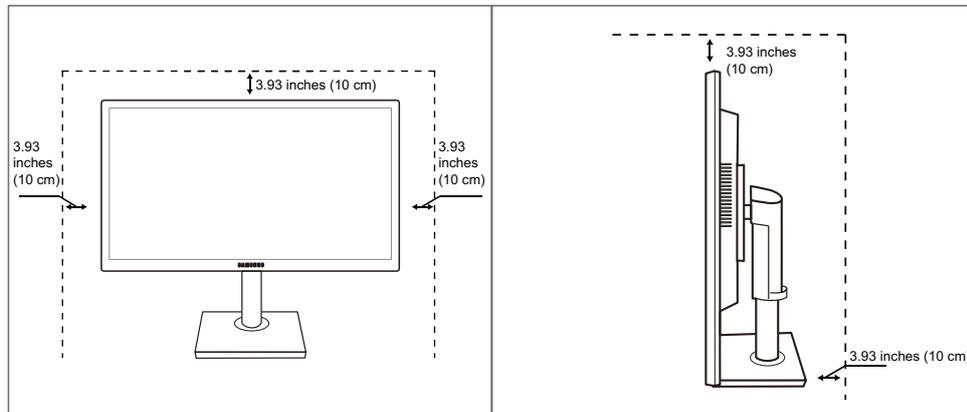

Precautions for storage



Be sure to contact Samsung Customer Service Center if the inside of the monitor needs cleaning. (A service fee will be charged.)

Before Using the Product

Safety Precautions

Caution
RISK OF ELECTRIC SHOCK DO NOT OPEN
Caution: TO REDUCE THE RISK OF ELECTRIC SHOCK, DO NOT REMOVE COVER (OR BACK). THERE ARE NO USER SERVICEABLE PARTS INSIDE. REFER ALL SERVICING TO QUALIFIED PERSONNEL.

	This symbol indicates that high voltage is present inside. It is dangerous to make any kind of contact with any internal part of this product.
	This symbol alerts you that important literature concerning operation and maintenance has been included with this product.

Symbols

 Warning	A serious or fatal injury may result if instructions are not followed.
 Caution	Personal injury or damage to properties may result if instructions are not followed.
	Activities marked by this symbol are prohibited.
	Instructions marked by this symbol must be followed.

Before Using the Product

Electricity and Safety



The following images are for reference only. Real-life situations may differ from what is shown in the images.

Warning



Do not use a damaged power cord or plug, or a loose power socket.

- An electric shock or fire may result.



Do not plug many products into the same power socket.

- Otherwise, the socket may overheat and cause a fire.



Do not touch the power plug with wet hands.

- Otherwise, an electric shock may result.



Insert the power plug all the way in so it is not loose.

- An unstable connection may cause a fire.



Ensure you connect the power plug to a grounded power socket. (type 1 insulated devices only).

- An electric shock or injury may result.



Do not bend or pull the power cord with force. Do not weigh the power cord down with a heavy object.

- A damaged power cord may cause an electric shock or fire.



Do not place the power cord or product near heat sources.

- An electric shock or fire may result.



Remove foreign substances such as dust around the plug pins and power socket with a dry cloth.

- Otherwise, a fire may result.

Before Using the Product

Caution



Do not unplug the power cord when the product is in use.

- The product may become damaged by an electric shock.

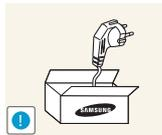

Do not use the power cord for products other than authorized products supplied by Samsung.

- An electric shock or fire may result.



Keep the power socket where the power cord is connected unobstructed.

- If any problem occurs in the product, unplug the power cable to completely cut the power to the product.

Power to the product cannot be completely cut off with the power button.



Hold the plug when disconnecting the power cord from the power socket.

- An electric shock or fire may result.

Installation and Safety

Warning



DO NOT PLACE CANDLES, INSECT REPELLANTS OR CIGARETTES ON TOP OF THE PRODUCT. DO NOT INSTALL THE PRODUCT NEAR HEAT SOURCES.

- Otherwise, a fire may result.



Avoid installing the product in a narrow space with bad ventilation, such as a bookshelf or wall closet.

- Otherwise, a fire may result due to an increased internal temperature.



Keep the plastic packaging bag for the product in a place that cannot be reached by children.

- Children may suffocate.

Before Using the Product



Do not install the product on an unstable or vibrating surface (insecure shelf, sloped surface, etc.).

- The product may fall and break or cause a personal injury.
- Using the product in an area with excess vibration may damage the product or cause a fire.



Do not install the product in a vehicle or a place exposed to dust, moisture (water drips, etc.), oil, or smoke.

- An electric shock or fire may result.



Do not expose the product to direct sunlight, heat, or a hot object such as a stove.

- Otherwise, the product lifespan may be reduced, or a fire may result.



Do not install the product within the reach of young children.

- The product may fall and injure children.



Edible oil (such as soybean oil) may damage or distort the product. Keep the product away from oil pollution.

And do not install or use the product in the kitchen or near the kitchen stove.

Caution



Take care not to drop the product when moving it.

- Otherwise, product failure or personal injury may result.



Do not set down the product on its front.

- The screen may become damaged.



When installing the product on a cabinet or shelf, make sure that the bottom edge of the front of the product is not protruding.

- The product may fall and break or cause a personal injury.
- Install the product only on cabinets or shelves of the right size.

Before Using the Product

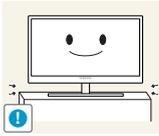

Put down the product carefully.

- The product may fall and break or cause a personal injury.



Installing the product in an unusual place (a place exposed to a lot of fine dust, chemical substances, extreme temperatures or a significant presence of moisture, or a place where the product will operate continuously for an extended period of time) may seriously affect its performance.

- Be sure to consult Samsung Customer Service Center before installation if you want to install the product at such a place.

Operation and Safety

Warning



High voltage runs through the product. Do not attempt to disassemble, repair, or modify the product on your own.

- An electric shock or fire may result.
- Contact Samsung Customer Service Center for repair.



To move the product, first disconnect all the cables from it, including the power cable.

- Otherwise, the power cord may be damaged and a fire or electric shock may result.



If the product generates a strange noise, a burning smell, or smoke, remove the power cord immediately and contact Samsung Customer Service Center.

- An electric shock or fire may result.



Do not let children hang from the product or climb on top of it.

- The product may fall, and your child may become injured or seriously harmed.



If the product falls or the exterior is damaged, power off the product, remove the power cord, and contact Samsung Customer Service Center.

- Otherwise, an electric shock or fire may result.



Do not put a heavy object, toy, or sweets on top of the product.

- The product or heavy objects may fall as children try to reach for the toy or sweets resulting in a serious injury.

Before Using the Product



If there is a thunderstorm or lightning strike, turn off the power and disconnect the power cable.

- An electric shock or fire may result.



Do not drop objects on the product or apply impact.

- An electric shock or fire may result.



Do not move the product by pulling the power cord or any cable.

- Otherwise, the cable may be damaged and product failure, an electric shock or fire may result.



If a gas leakage is found, do not touch the product or power plug. Also, ventilate the area immediately.

- Sparks can cause an explosion or fire.

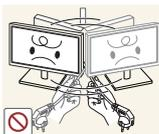

Do not lift or move the product by pulling the power cord or any cable.

- Otherwise, the cable may be damaged and product failure, an electric shock or fire may result.

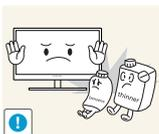

Do not use or keep combustible spray or an inflammable substance near the product.

- An explosion or fire may result.



Ensure the vents are not blocked by tablecloths or curtains.

- Otherwise, a fire may result from an increased internal temperature.



Do not insert a metallic object (a chopstick, coin, hair pin, etc.) or inflammable object (paper, match, etc.) into the vent or ports of the product.

- If water or any foreign substance enters the product, be sure to power off the product, remove the power cord, and contact Samsung Customer Service Center.
- Product failure, an electric shock or fire may result.



Do not place objects containing liquid (vases, pots, bottles, etc) or metallic objects on top of the product.

- If water or any foreign substance enters the product, be sure to power off the product, remove the power cord, and contact Samsung Customer Service Center.
- Product failure, an electric shock or fire may result.

Before Using the Product

Caution

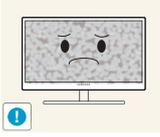

Leaving the screen fixed on a stationary image for an extended period of time may cause afterimage burn-in or defective pixels.

- If you are not going to use the product for an extended period of time, activate power-saving mode or a moving-picture screen saver.

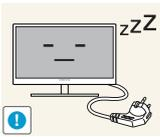

Disconnect the power cord from the power socket if you do not plan on using the product for an extended period of time (vacation, etc.).

- Otherwise, a fire may result from accumulated dust, overheating, an electric shock, or electric leakage.



Use the product at the recommended resolution and frequency.

- Otherwise, Your eyesight may deteriorate.



Do not put DC power adapters together.

- Otherwise, a fire may result.

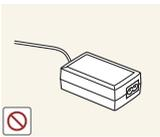

Remove the plastic bag from the DC power adapter before you use it.

- Otherwise, a fire may result.



Do not let water enter the DC power device or get the device wet.

- An electric shock or fire may result.
- Avoid using the product outdoors where it can be exposed to rain or snow.
- Be careful not to get the DC power adapter wet when you wash the floor.



Do not put the DC power adapter near to any heating apparatus.

- Otherwise, a fire may result.

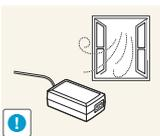

Keep the DC power adapter in a well-ventilated area.

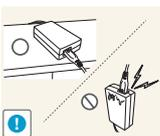

If you place the AC/DC power adapter so that it is hanging with the cord input facing upwards, water or other foreign substances could enter the Adapter and cause the Adapter to malfunction.

Make sure to rest the AC/DC power adapter flat on a table or the floor.

Before Using the Product

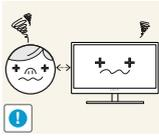

Looking at the screen too close for an extended period of time can deteriorate your eyesight.



Do not hold the monitor upside-down or move it by holding the stand.

- The product may fall and break or cause a personal injury.



Do not use humidifiers or stoves around the product.

- An electric shock or fire may result.

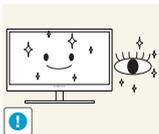

Rest your eyes for more than 5 minutes for every 1 hour of product use.

- Eye fatigue will be relieved.



Do not touch the screen when the product has been turned on for an extended period of time as it will become hot.



Store the small accessories used with the product out of reach of children.



Exercise caution when adjusting the product angle or stand height.

- Otherwise, children's fingers or hands may become stuck and injured.
- Tilting the product excessively may cause it to fall and result in personal injury.



Do not place heavy objects on the product.

- Product failure or personal injury may result.



When using headphones or earphones, do not turn the volume too high.

- Having the sound too loud may damage your hearing.

Correct posture to use the product



Use the product in the correct posture as follows:

- Straighten your back.
- Allow a distance of 45 to 50 cm between your eye and the screen, and look slightly downward at the screen.
Keep your eyes directly in front of the screen.
- Adjust the angle so light does not reflect on the screen.
- Keep your forearms perpendicular to your upper arms and level with the back of your hands.
- Keep your elbows at about a right angle.
- Adjust the height of the product so you can keep your knees bent at 90 degrees or more, your heels attached to the floor, and your arms lower than your heart.

1.1 Checking the Components

1.1.1 Checking the Components



- Contact the dealer from whom you purchased the product if any item is missing.
- The pictures may look different from the actual components.

Components



Quick setup guide



Warranty card (Not available in some locations)



Regulatory guide (optional)

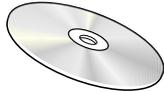

User manual (optional)



Power cable

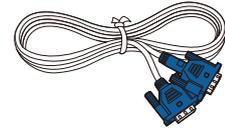

D-SUB cable (optional)

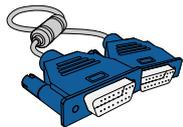

D-SUB cable (optional)

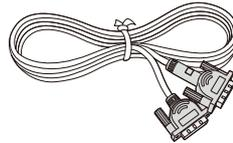

DVI cable (optional)

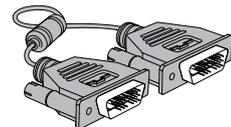

DVI cable (optional)

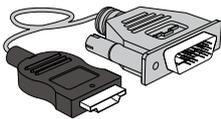

HDMI-DVI cable (optional)



DP cable (optional)

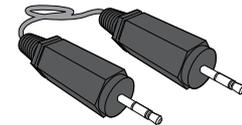

Stereo Cable
For S**E450M* Model (optional)

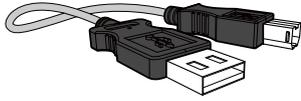

USB cable
(optional)



Stand base
For SE200 Series Model
(optional)



Stand base
For SE450 Series Model,
For SE650 Series Model
(optional)



Stand base
For SE450 Series Model
(Applicable to the stand
models that have USB ports
only.)
(optional)



Stand neck
For SE200 Series Model
(optional)



Stand neck
For SE450 Series Model,
For SE650 Series Model
(optional)



Components may vary depending on the country.

1.2 Parts

1.2.1 Frontal Buttons (SE200 Series)



The color and shape of parts may differ from what is shown. Specifications are subject to change without notice to improve quality.

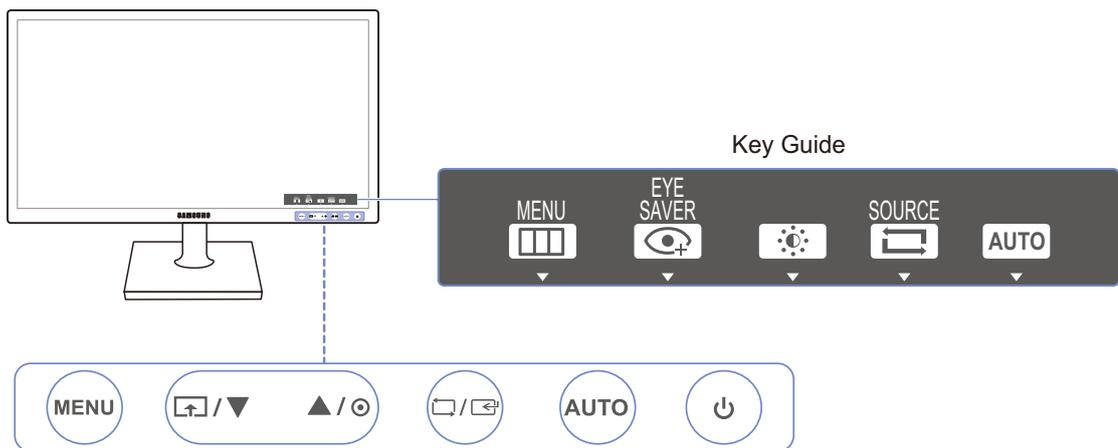

Icons	Description
MENU	<ul style="list-style-type: none"> Open or close the onscreen display (OSD) menu, or return to the parent menu. OSD control lock: Maintain the current settings, or lock the OSD control to prevent unintended changes to settings. Enable: To lock the OSD control, press the [MENU] button for 10 seconds. Disable: To unlock the locked OSD control, press the [MENU] button for more than 10 seconds. <p> If the OSD control is locked,</p> <ul style="list-style-type: none"> Brightness and Contrast can be adjusted. Eye Saver Mode is available. INFORMATION can be viewed. The Eye Saver Mode function can be used by pressing the [↑] button. (The Eye Saver Mode is available even when the OSD control is locked.)
	<p>Press [↑] to enable or disable Eye Saver Mode.</p> <p>The items below are not available if the Eye Saver Mode function is enable.</p> <ul style="list-style-type: none"> PICTURE → Brightness, Game Mode, SAMSUNG MAGICBright, SAMSUNG MAGICAngle COLOR SETUP&RESET → Smart Eco Saving
▲/▼	Move to the upper or lower menu or adjust the value for an option on the OSD menu.

Icons	Description
	<p>Use this button to control the brightness, contrast and sharpness of the screen.</p>
	<p>Confirm a menu selection.</p> <p>Pressing the [] button when the OSD menu is not displayed will change the input source (Analog/DVI). If you power on the product or change the input source by pressing the [] button, a message that shows the changed input source will appear at the top left corner of the screen.</p> <p> This function is not available for products with an Analog interface only.</p>
<p>AUTO</p>	<p>Press the [AUTO] button to automatically adjust the screen settings.</p> <p> <ul style="list-style-type: none"> • Changing the resolution in Display Properties will activate the Auto Adjustment function. • This function is only available in Analog mode. </p>
	<p>Turn the screen on or off.</p>
<p>Key Guide</p>	<p>When a control button on the product is pressed, the Key Guide will be displayed before the onscreen menu opens. (The guide shows the function of the button pressed.)</p> <p>To access the onscreen menu when the guide is displayed, press the corresponding button again.</p> <p>The Key Guide may vary depending on the function or product model. Refer to the actual product.</p>

1.2.2 Frontal Buttons (S**E450B*, S**E650B*)



The color and shape of parts may differ from what is shown. Specifications are subject to change without notice to improve quality.

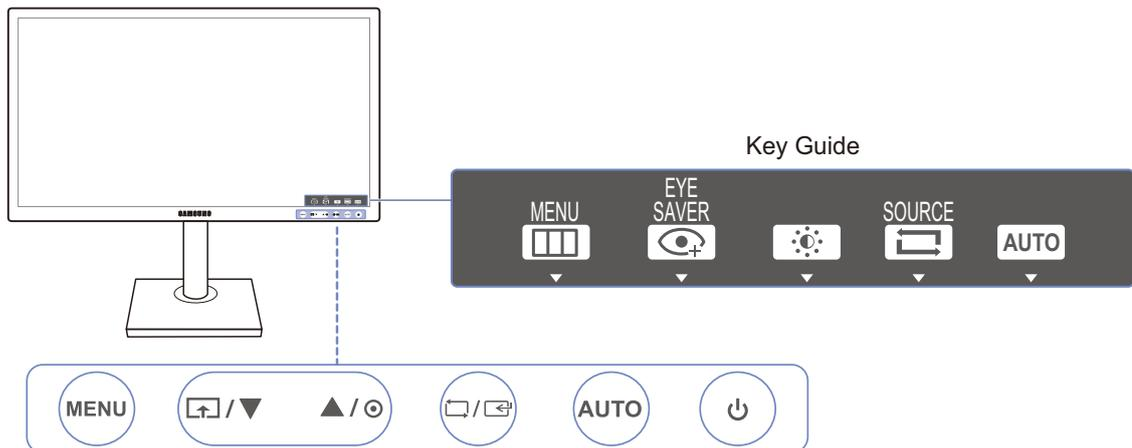

Icons	Description
MENU	<ul style="list-style-type: none"> Open or close the onscreen display (OSD) menu, or return to the parent menu. OSD control lock: Maintain the current settings, or lock the OSD control to prevent unintended changes to settings. Enable: To lock the OSD control, press the [MENU] button for 10 seconds. Disable: To unlock the locked OSD control, press the [MENU] button for more than 10 seconds. <p> If the OSD control is locked,</p> <ul style="list-style-type: none"> Brightness and Contrast can be adjusted. Eye Saver Mode is available. INFORMATION can be viewed. The Eye Saver Mode function can be used by pressing the [↕] button. (The Eye Saver Mode is available even when the OSD control is locked.)
↕	<p>Press [↕] to enable or disable Eye Saver Mode.</p> <p>The items below are not available if the Eye Saver Mode function is enable.</p> <ul style="list-style-type: none"> PICTURE → Brightness, Game Mode, SAMSUNG Bright, SAMSUNG Angle COLOR SETUP&RESET → Smart Eco Saving
▲/▼	Move to the upper or lower menu or adjust the value for an option on the OSD menu.
⦿	Use this button to control the brightness, contrast and sharpness of the screen.

Icons	Description
	<p>Confirm a menu selection.</p> <p>Pressing the [/] button when the OSD menu is not displayed will change the input source (Analog/DVI). If you power on the product or change the input source by pressing the [/] button, a message that shows the changed input source will appear at the top left corner of the screen.</p> <p> This function is not available for products with an Analog interface only.</p>
<p>AUTO</p>	<p>Press the [AUTO] button to automatically adjust the screen settings.</p> <p> <ul style="list-style-type: none"> • Changing the resolution in Display Properties will activate the Auto Adjustment function. • This function is only available in Analog mode. </p>
	<p>Turn the screen on or off.</p>
<p>Key Guide</p>	<p>When a control button on the product is pressed, the Key Guide will be displayed before the onscreen menu opens. (The guide shows the function of the button pressed.)</p> <p>To access the onscreen menu when the guide is displayed, press the corresponding button again.</p> <p>The Key Guide may vary depending on the function or product model. Refer to the actual product.</p>

1.2.3 Frontal Buttons (S**E450M*)



The color and shape of parts may differ from what is shown. Specifications are subject to change without notice to improve quality.

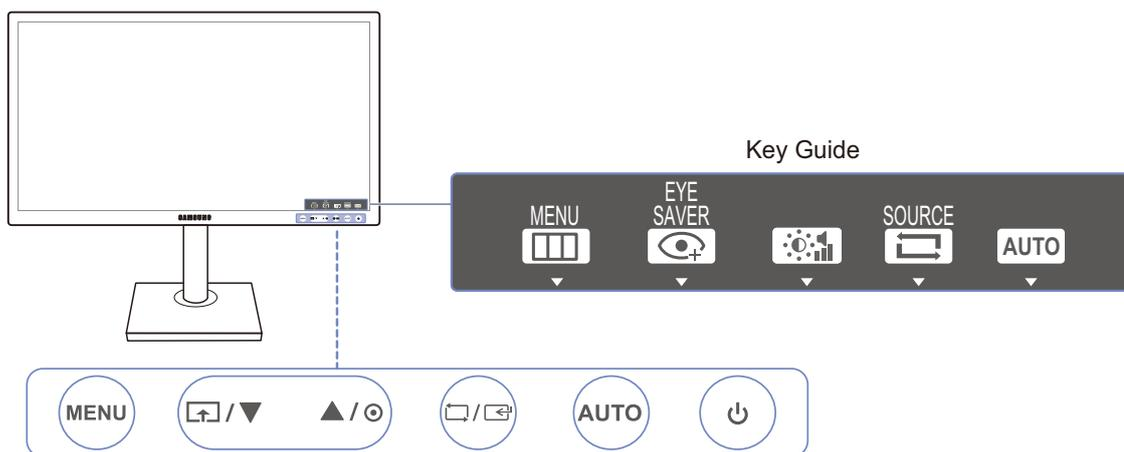

Icons	Description
MENU	<ul style="list-style-type: none"> Open or close the onscreen display (OSD) menu, or return to the parent menu. OSD control lock: Maintain the current settings, or lock the OSD control to prevent unintended changes to settings. Enable: To lock the OSD control, press the [MENU] button for 10 seconds. Disable: To unlock the locked OSD control, press the [MENU] button for more than 10 seconds. <p> If the OSD control is locked,</p> <ul style="list-style-type: none"> Brightness and Contrast can be adjusted. Eye Saver Mode is available. INFORMATION can be viewed. The Eye Saver Mode function can be used by pressing the [] button. (The Eye Saver Mode is available even when the OSD control is locked.)
	<p>Press [] to enable or disable Eye Saver Mode.</p> <p>The items below are not available if the Eye Saver Mode function is enable.</p> <ul style="list-style-type: none"> PICTURE → Brightness, Game Mode, SAMSUNG MAGIC Bright, SAMSUNG MAGIC Angle COLOR SETUP&RESET → Smart Eco Saving
▲/▼	Move to the upper or lower menu or adjust the value for an option on the OSD menu.
	Use this button to control the brightness and contrast of the screen.
	<p> Volume can be adjusted if a cable is connected to the [IN] port.</p>

Icons	Description
	<p>Confirm a menu selection.</p> <p>Pressing the [] button when the OSD menu is not displayed will change the input source (Analog/DVI). If you power on the product or change the input source by pressing the [] button, a message that shows the changed input source will appear at the top left corner of the screen.</p> <p> This function is not available for products with an Analog interface only.</p>
<p>AUTO</p>	<p>Press the [AUTO] button to automatically adjust the screen settings.</p> <p> <ul style="list-style-type: none"> Changing the resolution in Display Properties will activate the Auto Adjustment function. This function is only available in Analog mode. </p>
	<p>Turn the screen on or off.</p>
<p>Key Guide</p>	<p>When a control button on the product is pressed, the Key Guide will be displayed before the onscreen menu opens. (The guide shows the function of the button pressed.)</p> <p>To access the onscreen menu when the guide is displayed, press the corresponding button again.</p> <p>The Key Guide may vary depending on the function or product model. Refer to the actual product.</p>

1.2.4 Frontal Buttons (S**E450D*)



The color and shape of parts may differ from what is shown. Specifications are subject to change without notice to improve quality.

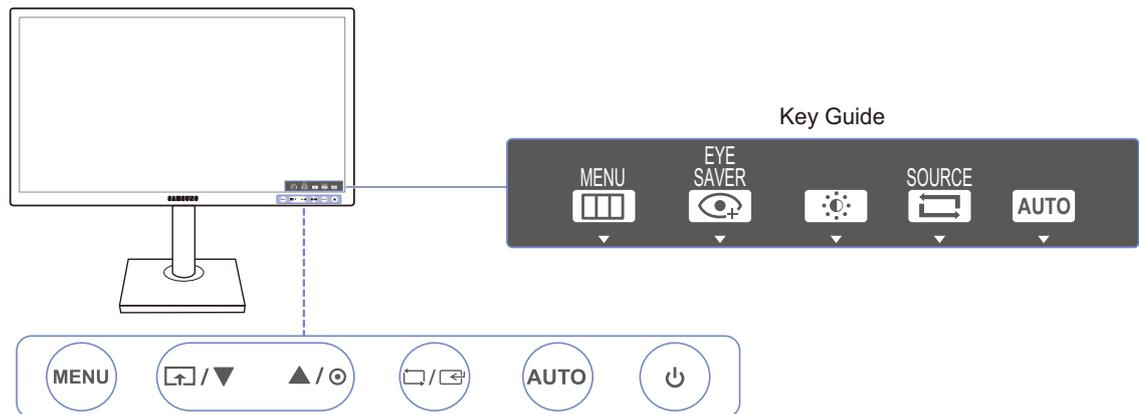

Icons	Description
MENU	<ul style="list-style-type: none"> Open or close the onscreen display (OSD) menu, or return to the parent menu. OSD control lock: Maintain the current settings, or lock the OSD control to prevent unintended changes to settings. Enable: To lock the OSD control, press the [MENU] button for 10 seconds. Disable: To unlock the locked OSD control, press the [MENU] button for more than 10 seconds. <p> If the OSD control is locked,</p> <ul style="list-style-type: none"> Brightness and Contrast can be adjusted. Eye Saver Mode is available. INFORMATION can be viewed. The Eye Saver Mode function can be used by pressing the [↑] button. (The Eye Saver Mode is available even when the OSD control is locked.)
	<p>Press [↑] to enable or disable Eye Saver Mode.</p> <p>The items below are not available if the Eye Saver Mode function is enable.</p> <ul style="list-style-type: none"> PICTURE → Brightness, Game Mode, SAMSUNG MAGIC Bright, SAMSUNG MAGIC Angle COLOR SETUP&RESET → Smart Eco Saving
▲/▼	Move to the upper or lower menu or adjust the value for an option on the OSD menu.
	Use this button to control the brightness, contrast and sharpness of the screen.

Icons	Description
	<p>Confirm a menu selection.</p> <p>Pressing the [] button when the OSD menu is not displayed will change the input source (Analog/DVI/DisplayPort). If you power on the product or change the input source by pressing the [] button, a message that shows the changed input source will appear at the top left corner of the screen.</p> <p> This function is not available for products with an Analog interface only.</p>
<p>AUTO</p>	<p>Press the [AUTO] button to automatically adjust the screen settings.</p> <p> <ul style="list-style-type: none"> • Changing the resolution in Display Properties will activate the Auto Adjustment function. • This function is only available in Analog mode. </p>
	<p>Turn the screen on or off.</p>
<p>Key Guide</p>	<p>When a control button on the product is pressed, the Key Guide will be displayed before the onscreen menu opens. (The guide shows the function of the button pressed.)</p> <p>To access the onscreen menu when the guide is displayed, press the corresponding button again.</p> <p>The Key Guide may vary depending on the function or product model.</p> <p>Refer to the actual product.</p>

1.2.5 Reverse Side (SE200 Series)



The color and shape of parts may differ from what is shown. Specifications are subject to change without notice to improve quality.

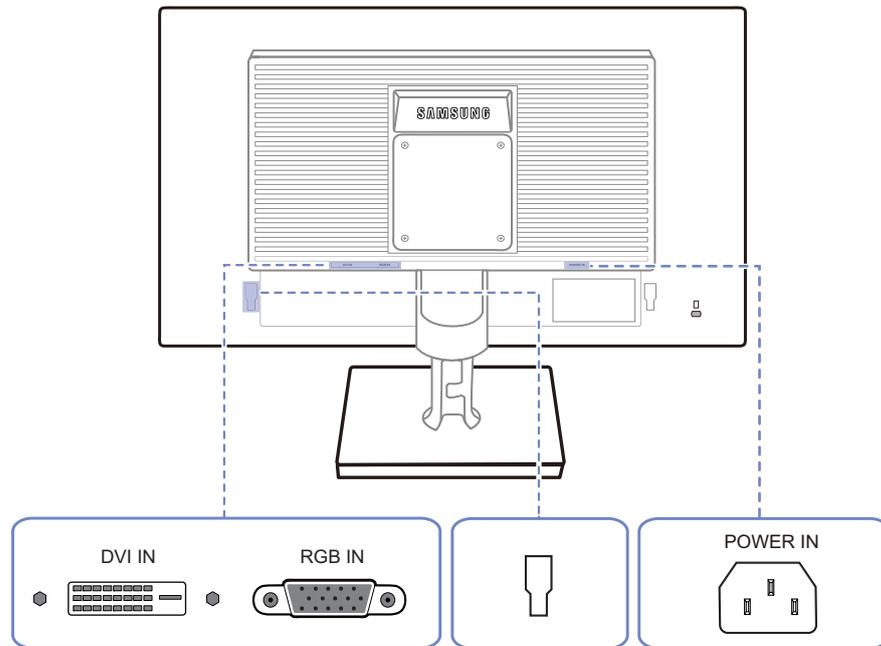

Port	Description
	Connect to a PC using the DVI cable.  The [DVI IN] terminal is supplied for the digital (DVI)-dedicated models only.
	Connect to a PC using the D-SUB cable.
	Connect to an external device.
	Connect the power cord for your monitor to the [POWER IN] port on the back of the product.

1.2.6 Reverse Side (S**E450B*, S**E650B*)



The color and shape of parts may differ from what is shown. Specifications are subject to change without notice to improve quality.

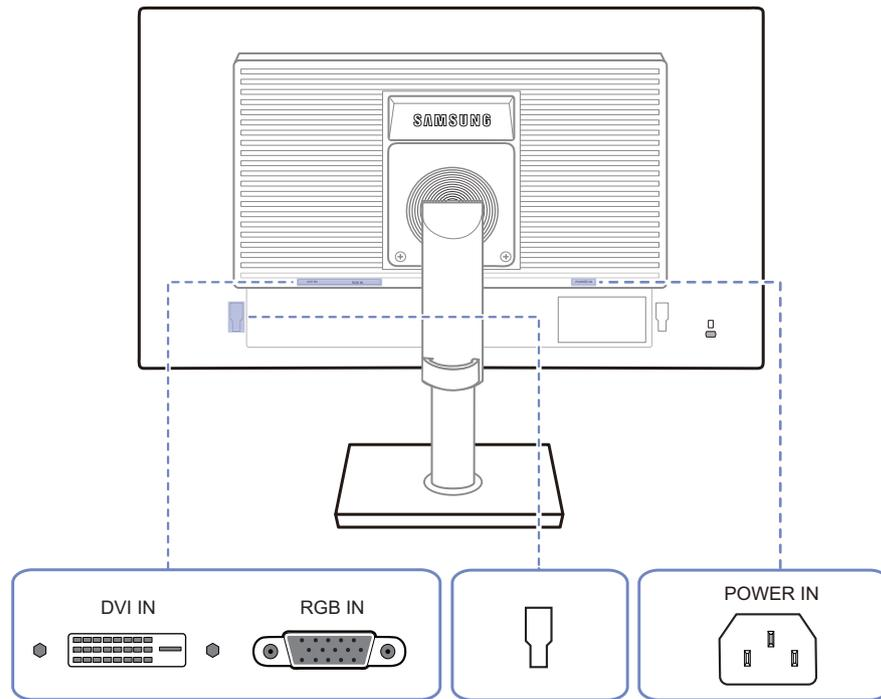

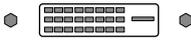
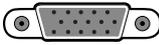
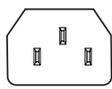
Port	Description
	Connect to a PC using the DVI cable.  The [DVI IN] terminal is supplied for the digital (DVI)-dedicated models only.
	Connect to a PC using the D-SUB cable.
	Connect to an external device.
	Connect the power cord for your monitor to the [POWER IN] port on the back of the product.

1.2.7 Reverse Side (S**E450M*)



The color and shape of parts may differ from what is shown. Specifications are subject to change without notice to improve quality.

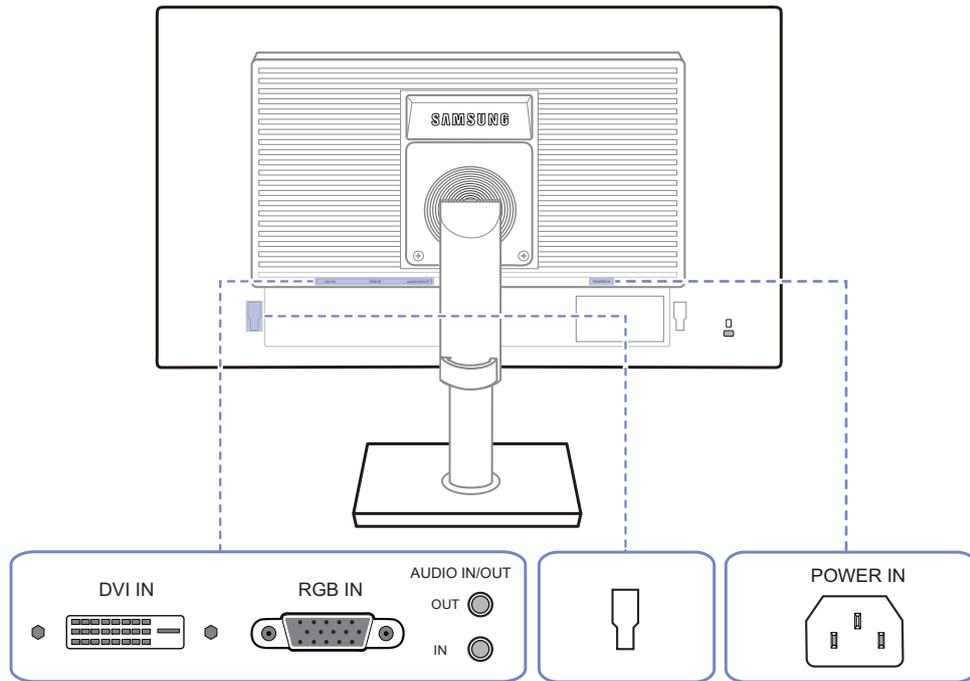

Port	Description
	Connect to a PC using the DVI cable. The [DVI IN] terminal is supplied for the digital (DVI)-dedicated models only.
	Connect to a PC using the D-SUB cable.
	Connect to an audio output device such as headphones. Applicable to the models that have speakers only.
	Connect to an audio-input source using an audio cable. Applicable to the models that have speakers only.
	Connect to an external device.
	Connect the power cord for your monitor to the [POWER IN] port on the back of the product.

1.2.8 Reverse Side (S**E450D*)



The color and shape of parts may differ from what is shown. Specifications are subject to change without notice to improve quality.

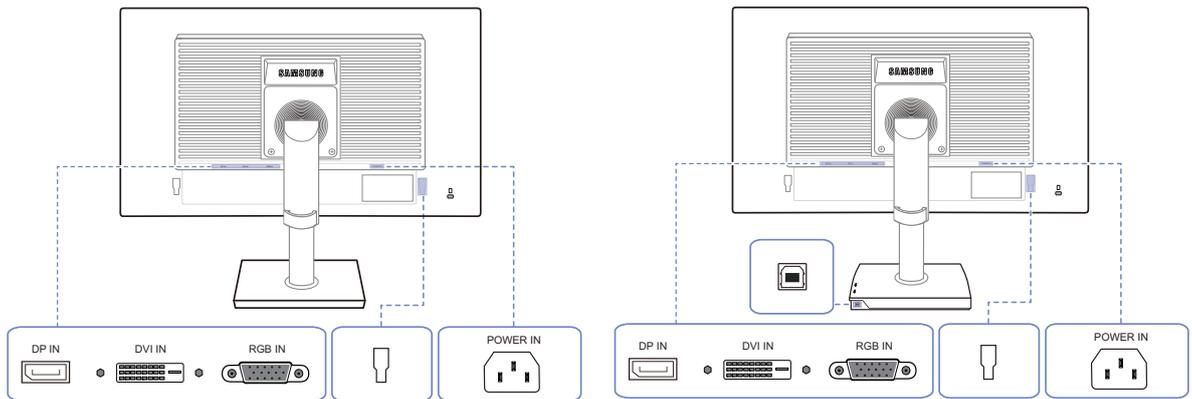

Port	Description
	Connect to a PC using a DP cable.
	Connect to a PC using the DVI cable. The [DVI IN] terminal is supplied for the digital (DVI)-dedicated models only.
	Connect to a PC using the D-SUB cable.
	Connect to a computer using a USB cable. This port can connect to a PC only. Applicable to the stand models that have USB ports only.
	Connect to an external device.
	Connect the power cord for your monitor to the [POWER IN] port on the back of the product.

1.2.9 Right Side View (S**E450D*)



The color and shape of parts may differ from what is shown. Specifications are subject to change without notice to improve quality.

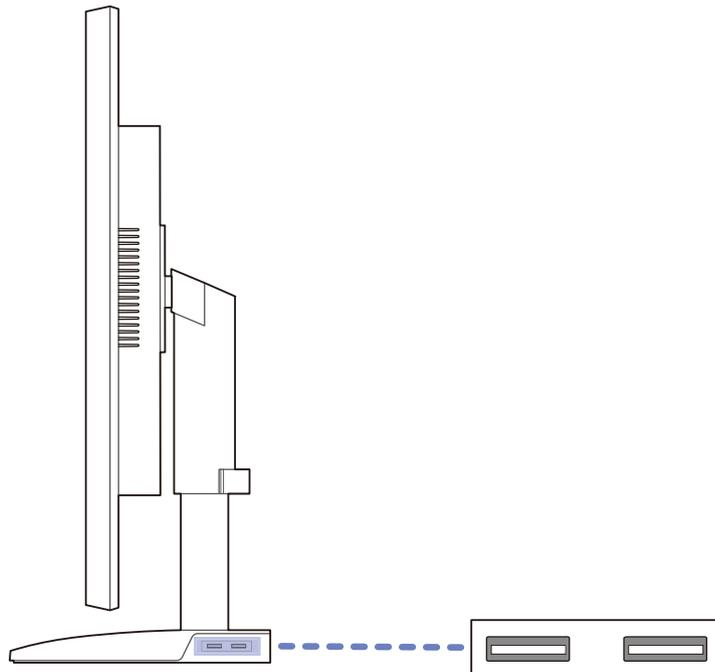

Port	Description
	Connect to a USB device.  Applicable to the stand models that have USB ports only.

1.3 Installation

1.3.1 Attaching the Stand (SE200 Series)



Before assembling the product, place the product down on a flat and stable surface so that the screen is facing downwards.

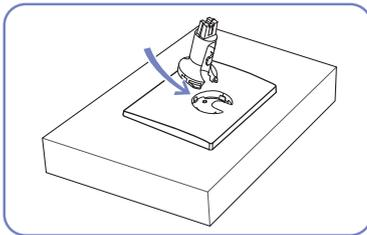

Insert the Stand Connector into the Stand in the direction shown by the figure.

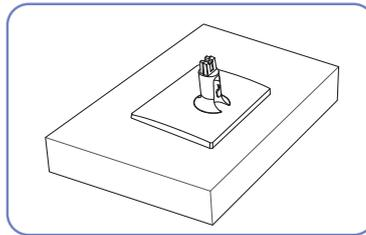

Check if the Stand Connector is firmly connected.

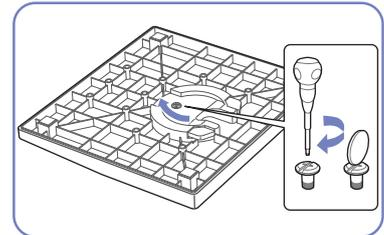

Turn the connecting screw at the bottom of the stand fully so that it is completely fixed.

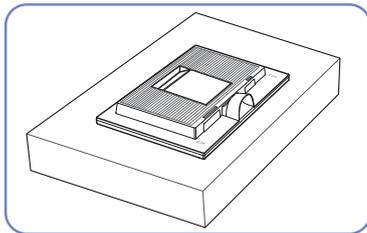

Place a soft cloth over the table to protect the product and place the product onto the cloth so that the front of the product is facing downwards.

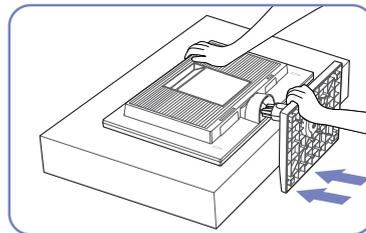

Hold the main body of the product with your hand as shown by the figure.

Push the assembled stand into the main body in the direction of the arrow as shown in the figure.



- Caution

Do not hold the product upside down only by the stand.



The color and shape of parts may differ from what is shown. Specifications are subject to change without notice to improve quality.

1.3.2 Attaching the Stand (SE450, SE650 Series)

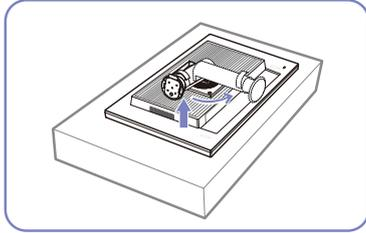

Place a protective cloth or cushion on a flat surface. Next, place the product with the face down on top of the cloth or cushion.

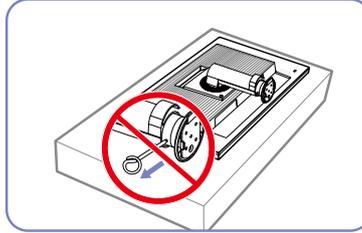

Do not remove the fixing pin until you are finished attaching the stand.

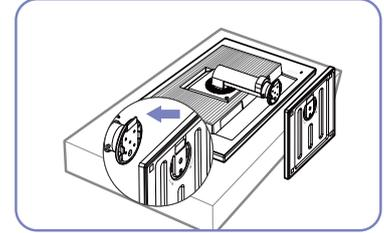

Insert the stand base into the stand in the direction of the arrow.

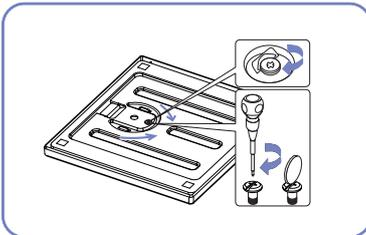

Fasten the screw tightly (using a screwdriver or coin) into the bottom of the stand base.

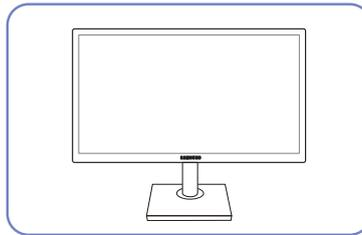

After installing the stand, place the product upright.

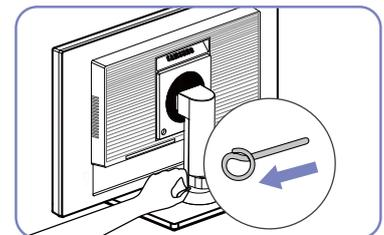

You can remove the fixing pin and adjust the stand now.



- Caution

Do not hold the product upside down only by the stand.



- Disassembly is the reverse order of assembly.
- The color and shape of parts may differ from what is shown. Specifications are subject to change without notice to improve quality.

1.3.3 Removing the Stand (SE200 Series)



The exterior may differ depending on the product.

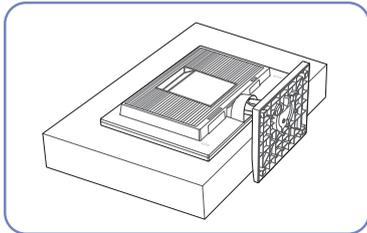

Place a soft cloth over the table to protect the product and place the product onto the cloth so that the front of the product faces downwards.

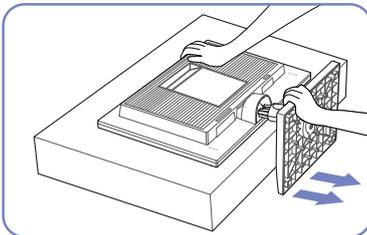

While holding the stand neck with one hand, pound the other fist down onto the top of the stand base in the direction of the arrow to detach the stand base.

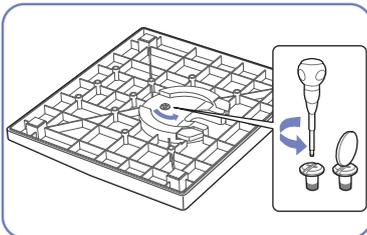

Turn the connecting screw at the bottom of the stand base to separate it.

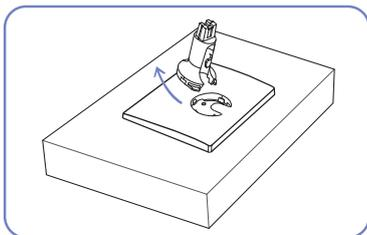

Remove the stand neck from the stand base by pulling it in the direction of the arrow as shown in the figure.

1.3.4 Adjusting the Product Tilt (SE200 Series)



The color and shape of parts may differ from what is shown. Specifications are subject to change without notice to improve quality.

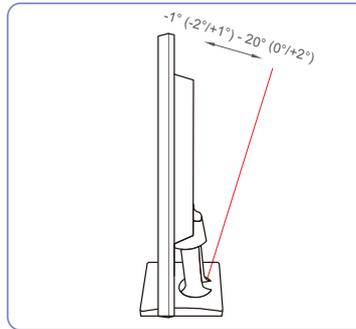

- You can adjust the tilt of your monitor.
- Hold the lower part of the product and adjust the tilt carefully.

1.3.5 Adjusting the Product Tilt and Height (SE450, SE650 Series)



The color and shape of parts may differ from what is shown. Specifications are subject to change without notice to improve quality.

19"-24"
-3°(±2°) - 25°(±2°)

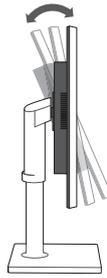
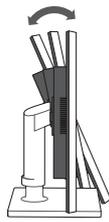

27"
-4°(±2°) - 25°(±2°)

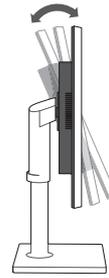
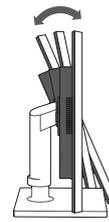

19"-22" (without a USB port)

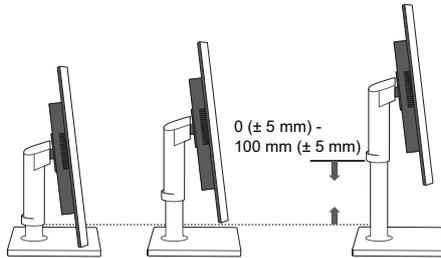

23"-27" / 21.5", 22" (with a USB port)

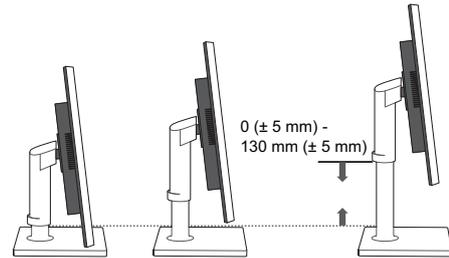

- To adjust the height, remove the fixing pin.
- The monitor tilt and height can be adjusted.
- Hold the top center of the product and adjust the height carefully.

1.3.6 Rotating the Monitor (SE450, SE650 Series)

You can rotate your monitor as shown below.

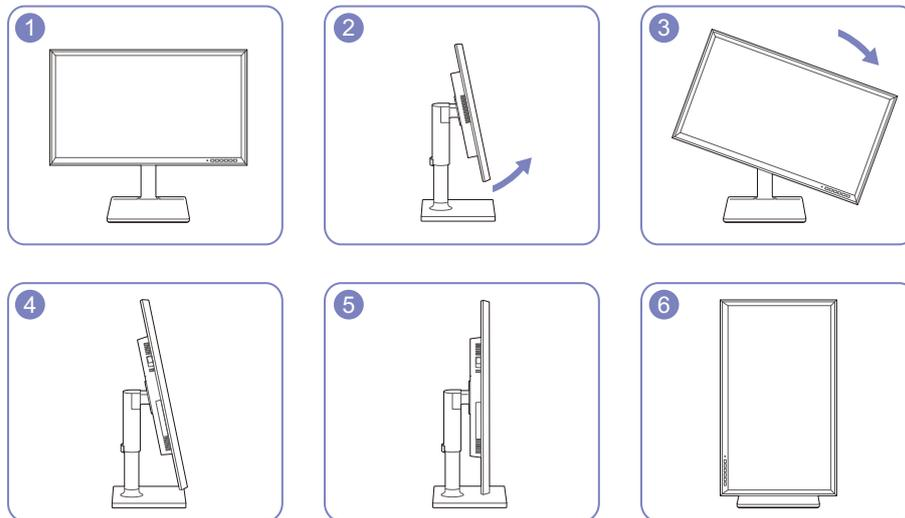

- Be sure to fully extend the stand before rotating the monitor.
- If you rotate the monitor without fully extending the stand, the corner of the monitor may hit the floor and get damaged.
- Do not rotate the monitor counterclockwise. The monitor may get damaged.

1.3.7 Installing a Wall-mount Kit or Desktop Stand

Before Installation



Power the product off and remove the power cable from the power socket.

SE200 Series

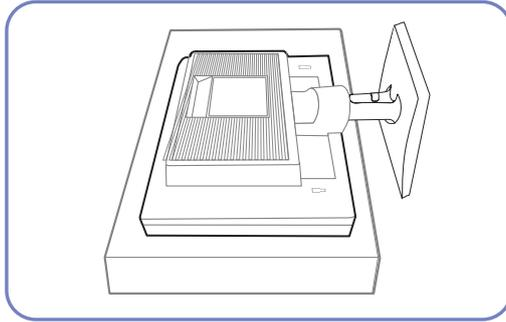

Place a protective cloth or cushion on a flat surface. Next, place the product with the face down on top of the cloth or cushion.

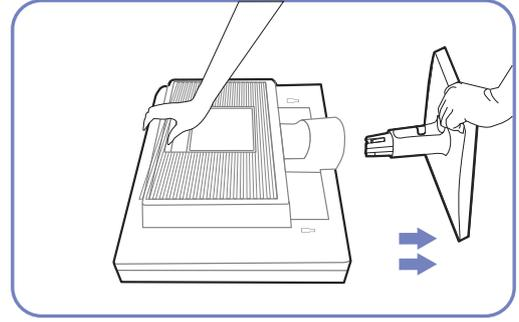

Hold the main body of the product with your hand as shown by the figure.

Pull the stand in the direction of the arrow as shown in the figure to separate it.

SE450, SE650 Series

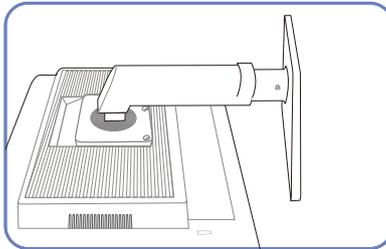

Place a protective cloth or cushion on a flat surface. Next, place the product with the face down on top of the cloth or cushion.

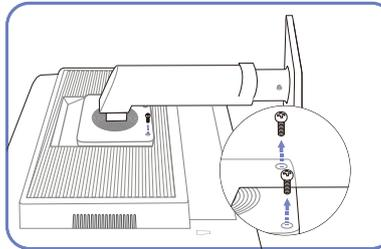

Unfasten the screw from the back of the product.

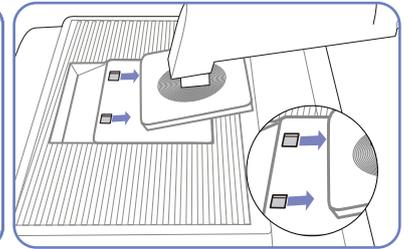

Lift and detach the stand.

Installing a Wall-mount Kit or Desktop Stand (SE200 Series)

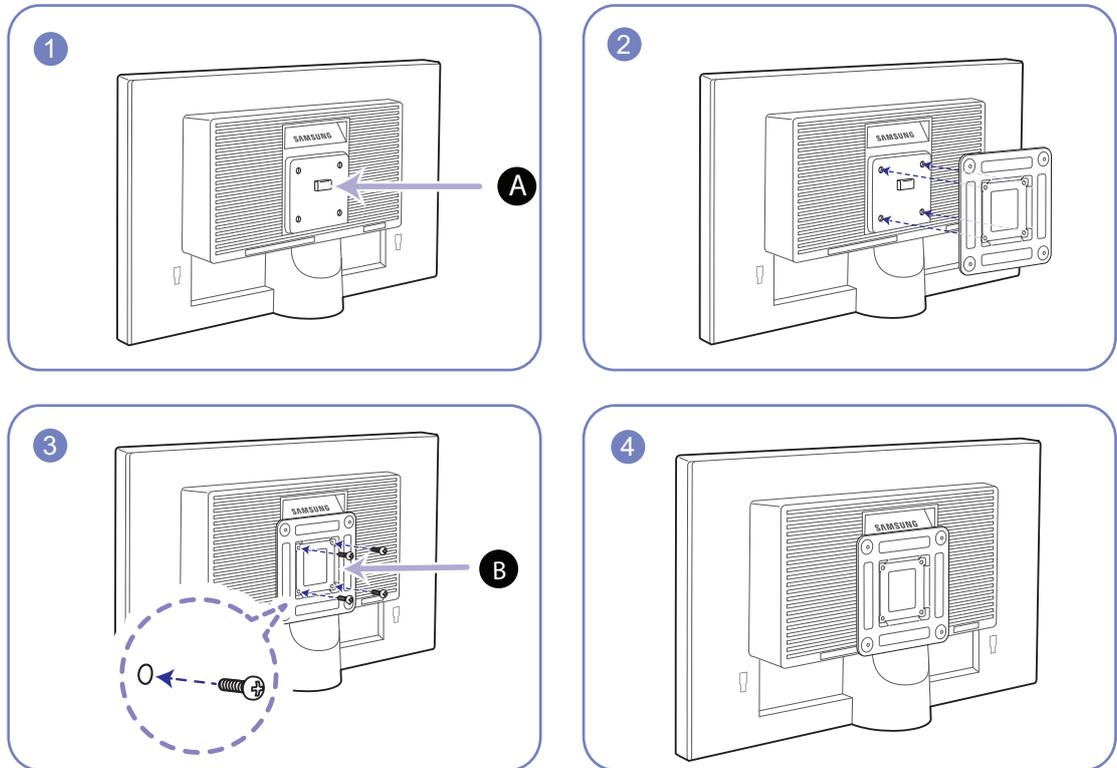

A Attach the wall-mount kit or desktop stand here

B Bracket (sold separately)

Align the grooves and tightly fasten the screws on the bracket on the product with the corresponding parts on the wall-mount kit or desktop stand you want to attach.



Notes

- Using a screw longer than the standard length can damage the internal components of the product.
- The length of screws required for a wall mount that does not comply with the VESA standards may vary depending on the specifications.
- Do not use screws that do not comply with the VESA standards. Do not attach the wall-mount kit or desktop stand using excessive force. The product may get damaged or fall and cause personal injury. Samsung shall not be held liable for any damage or injury caused by using improper screws or attaching the wall-mount kit or desktop stand using excessive force.
- Samsung shall not be held liable for any product damage or personal injury caused by using a wall-mount kit other than the one specified or from an attempt to install the wall-mount kit on your own.
- To mount the product on a wall, ensure you purchase a wall-mount kit that can be installed 10cm or farther away from the wall.
- Be sure to use a wall-mount kit that complies with the standards.

Installing a Wall-mount Kit or Desktop Stand (SE450, SE650 Series)

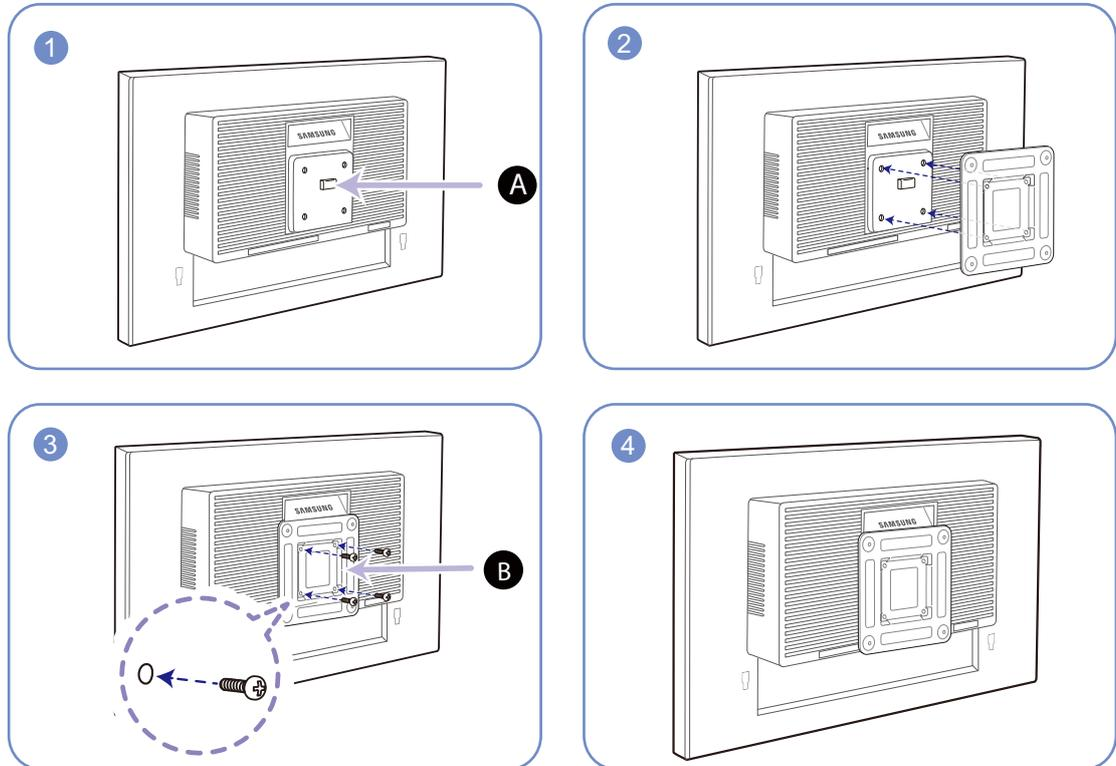

A Attach the wall-mount kit or desktop stand here

B Bracket (sold separately)

Align the grooves and tightly fasten the screws on the bracket on the product with the corresponding parts on the wall-mount kit or desktop stand you want to attach.



Notes

- Using a screw longer than the standard length can damage the internal components of the product.
- The length of screws required for a wall mount that does not comply with the VESA standards may vary depending on the specifications.
- Do not use screws that do not comply with the VESA standards. Do not attach the wall-mount kit or desktop stand using excessive force. The product may get damaged or fall and cause personal injury. Samsung shall not be held liable for any damage or injury caused by using improper screws or attaching the wall-mount kit or desktop stand using excessive force.
- Samsung shall not be held liable for any product damage or personal injury caused by using a wall-mount kit other than the one specified or from an attempt to install the wall-mount kit on your own.
- To mount the product on a wall, ensure you purchase a wall-mount kit that can be installed 10cm or farther away from the wall.
- Be sure to use a wall-mount kit that complies with the standards.
- To install the monitor using a wall mount, disconnect the stand base from the monitor.

1.3.8 Anti-theft Lock

An anti-theft lock allows you to use the product securely even in public places. The locking device shape and locking method depend on the manufacturer. Refer to the user guide provided with your anti-theft locking device for details. The lock device is sold separately.

SE200 Series

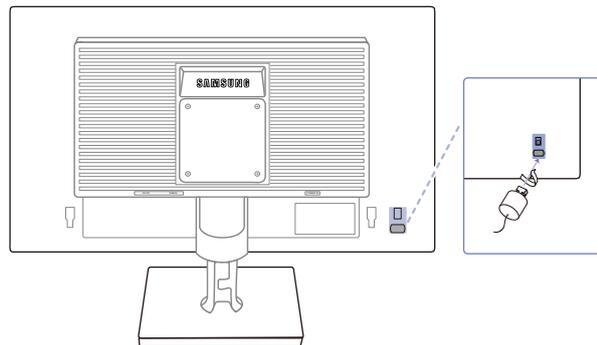

SE450, SE650 Series

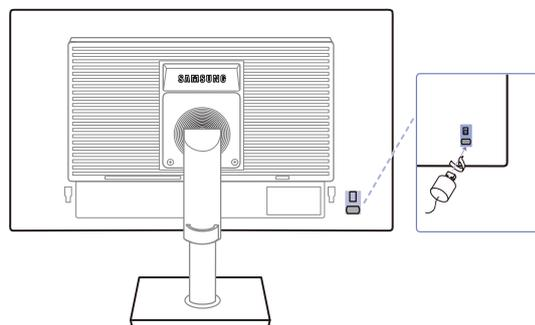

The color and shape of parts may differ from what is shown. Specifications are subject to change without notice to improve quality.

To lock an anti-theft locking device:

- 1 Fix the cable of your anti-theft locking device to a heavy object such as a desk.
- 2 Put one end of the cable through the loop on the other end.
- 3 Insert the locking device into the anti-theft lock slot at the back of the product.
- 4 Lock the locking device.



- An anti-theft locking device can be purchased separately.
- Refer to the user guide provided with your anti-theft locking device for details.
- Anti-theft locking devices can be purchased at electronics retailers or online.

2.1 Before Connecting

2.1.1 Pre-connection Checkpoints

- Before connecting a source device, read the user manual provided with it.
The number and locations of ports on source devices may differ from device to device.
- Do not connect the power cable until all connections are completed.
Connecting the power cable during connection may damage the product.
- Check the types of ports at the back of the product you want to connect.

2.2 Connecting and Using a PC

2.2.1 Connecting to a PC

- Select a connection method suitable for your PC.
- 
 - Connecting parts may differ in different products.
 - The exterior may differ depending on the product.

Connection Using the D-SUB Cable (Analog Type)

- 
 - Do not connect the power cable before connecting all other cables. Ensure you connect a source device first before connecting the power cable.

SE200 Series

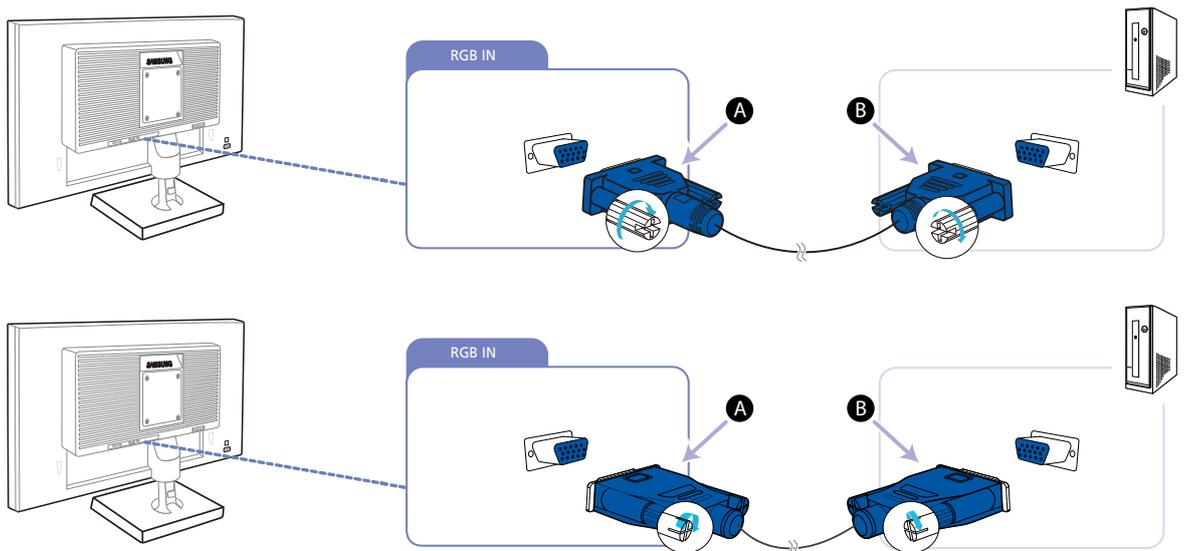

2

Connecting and Using a Source Device

SE450, SE650 Series

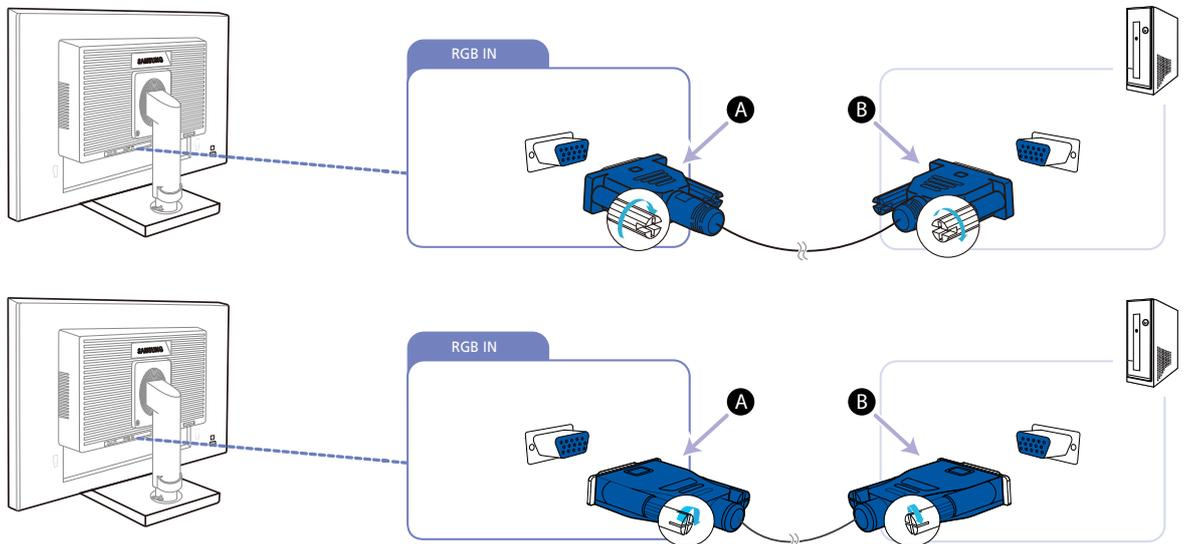

- 1 Connect the D-SUB cable to the [RGB IN] port on the back of the product and the RGB port on the PC.
 - ✎ Connect **A** to the [RGB IN] port on the product, then connect **B** to the RGB port on the computer.
- 2 Press [/] to change the input source to **Analog**.
 - ✎ This function is not available for products with an Analog interface only.

Connection Using the DVI Cable

- Do not connect the power cable before connecting all other cables. Ensure you connect a source device first before connecting the power cable.

SE200 Series

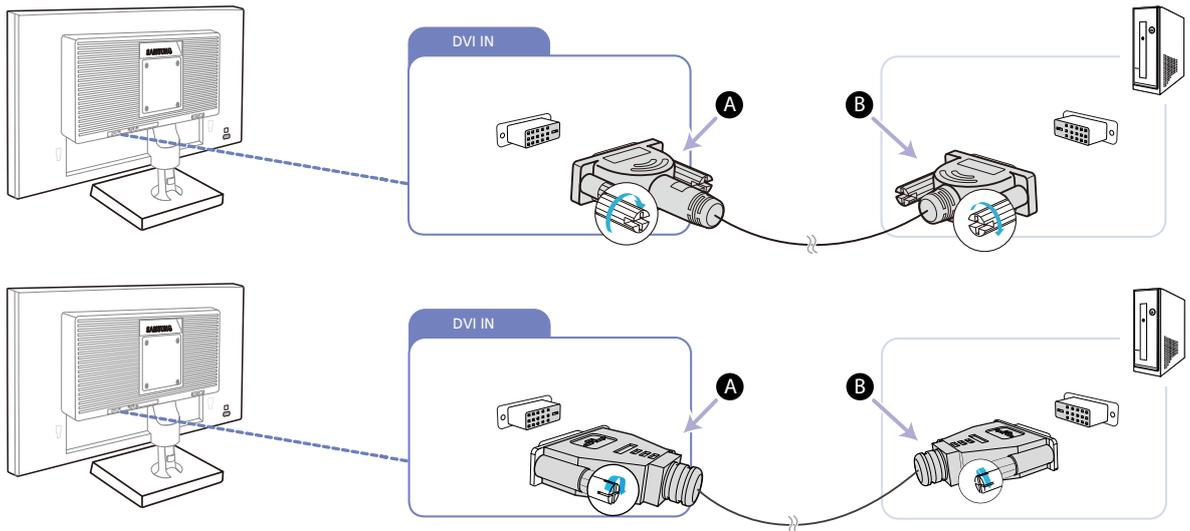

SE450, SE650 Series

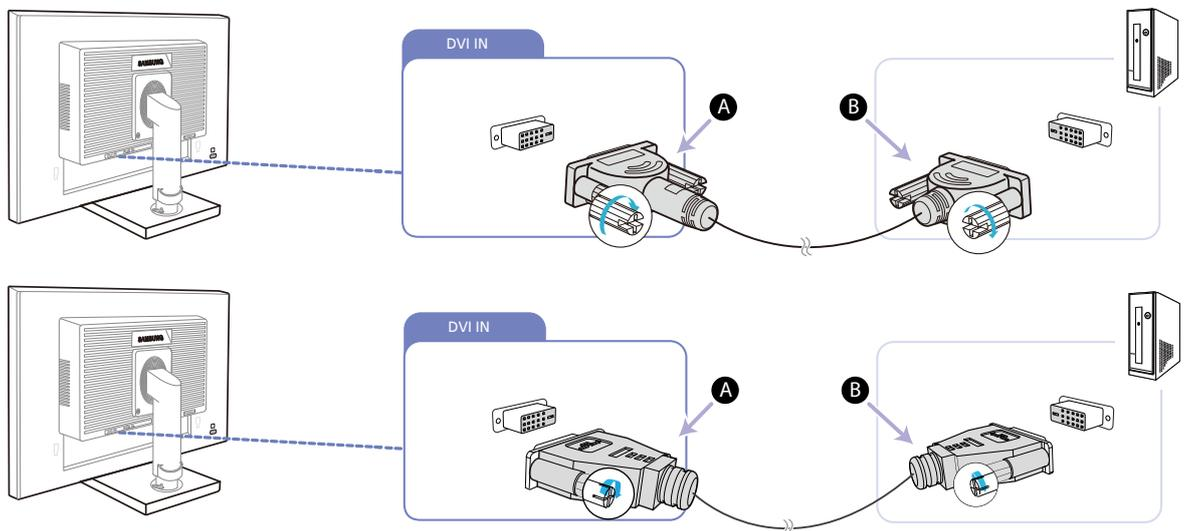

- Connect the DVI cable to the [DVI IN] port on the back of the product and the DVI port on the PC.
 - Connect **A** to the [DVI IN] port on the product, then connect **B** to the DVI port on the computer.
- Press [] to change the input source to **DVI**.
 - The [DVI IN] terminal is supplied for the digital (DVI)-dedicated models only.

Connection Using the DVI-HDMI Cable



Do not connect the power cable before connecting all other cables. Ensure you connect a source device first before connecting the power cable.

SE200 Series

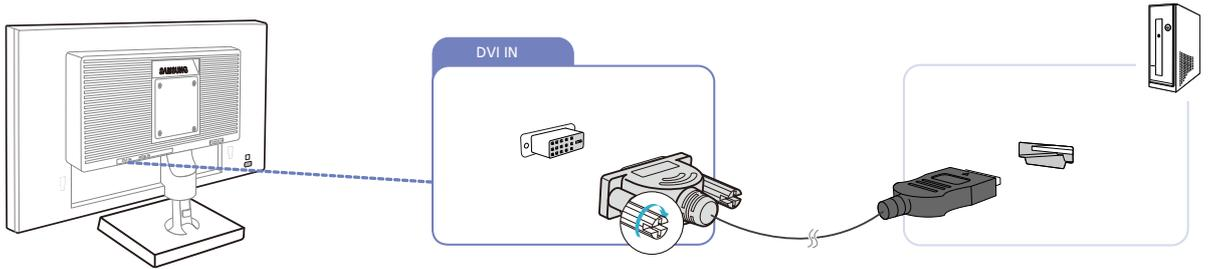

SE450, SE650 Series

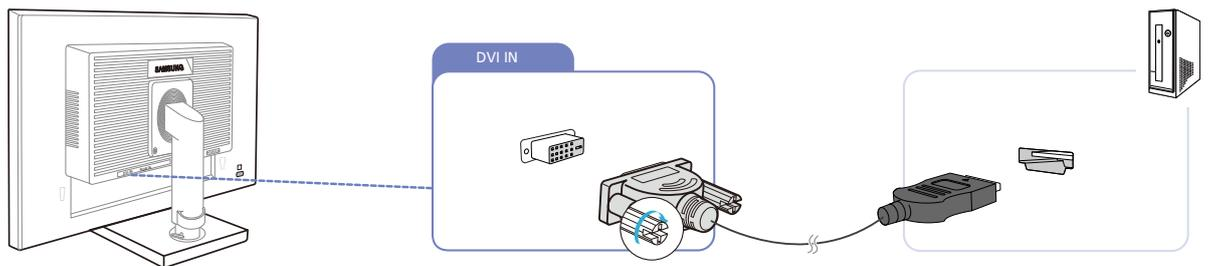

- 1 Connect the HDMI-DVI cable to the [DVI IN] port on the back of the product and the HDMI port on the PC.
- 2 Press [⏏/⏏] to change the input source to **DVI**.



The [DVI IN] terminal is supplied for the digital (DVI)-dedicated models only.

Connection Using the DP Cable



Do not connect the power cable before connecting all other cables.

Ensure you connect a source device first before connecting the power cable.

S**E450D*

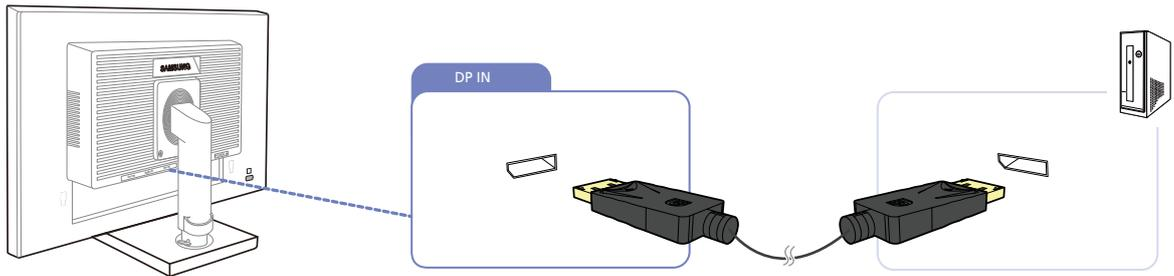

- 1 Connect the DP cable to the [DP IN] port on the back of the product and the DP port on the PC.
- 2 Press [⏏/⏏] to change the input source to **DisplayPort**.

Connecting to Headphones or Speakers



Do not connect the power cable before connecting all other cables. Ensure you connect a source device first before connecting the power cable.

S**E450M*

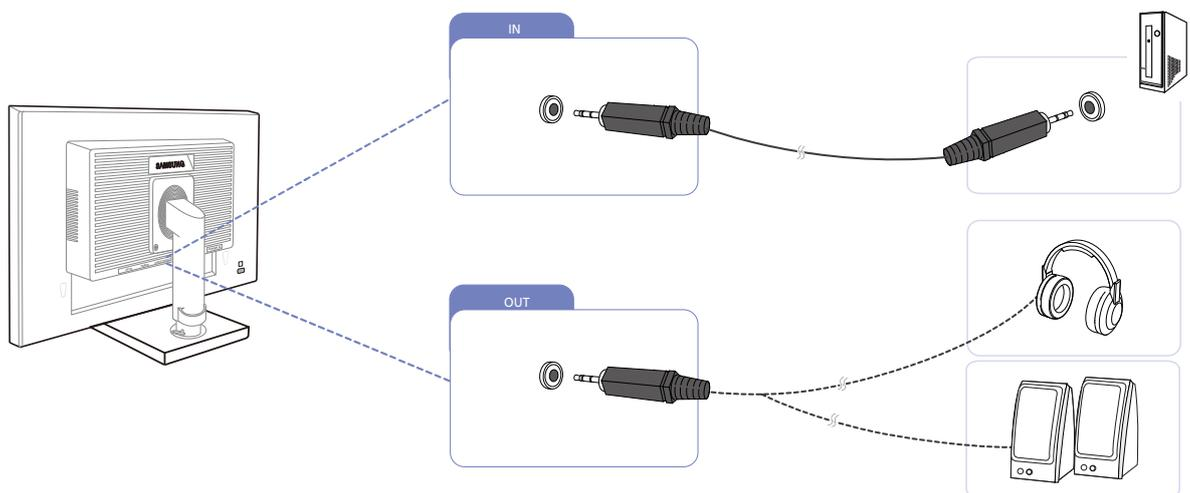

- 1 Connect an audio output device such as headphones or speakers to [OUT] port on the product.



Applicable to the models that have speakers only.

- 2 Connect an audio input device such as a computer to the [IN] port on the product.



Applicable to the models that have speakers only.

2.2.2 Connecting the Power



- Connecting parts may differ in different products.
- The exterior may differ depending on the product.
- To use the product, connect the power cable to a power outlet and the [POWER IN] port on the product.

SE200 Series

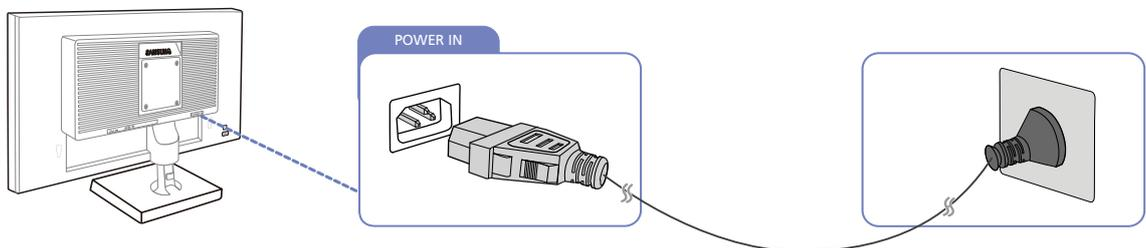

SE450, SE650 Series

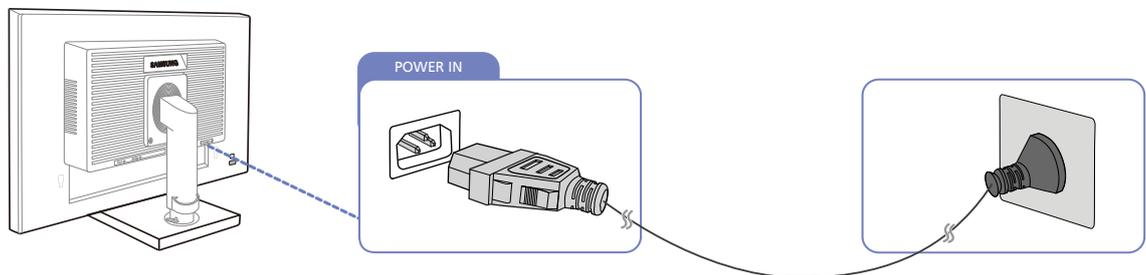

The input voltage is switched automatically.

Connecting USB (S**E450D* Models)



- Applicable to the stand models that have USB ports only.
- You can use a USB device such as a mouse, keyboard, memory stick or external hard disk drive (HDD) by connecting it directly to the [] port on the monitor. You do not need to connect it to the computer.
An external mass-storage HDD requires an external power supply and be sure to connect it to a power source.

The [] USB port of the monitor supports High-Speed Certified USB 2.0.

	High speed	Full speed	Low speed
Data Rate	480 Mbps	12 Mbps	1.5 Mbps
Power Consumption	2.5 W (Max., each port)	2.5 W (Max., each port)	2.5 W (Max., each port)

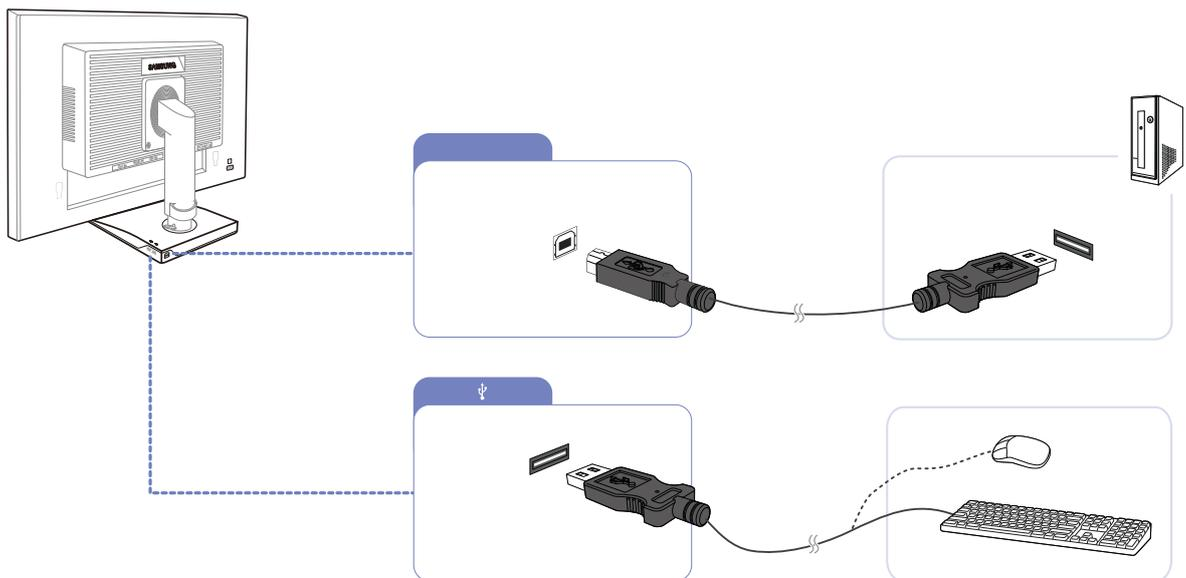

- 1 Connect the [] port of the monitor and the USB port of the computer with the USB cable.



- To use [] port, you have to connect the UP (Upstream Cable) to the PC.
- Make sure to use the USB cable supplied with this monitor to connect the monitor's [] port and your computer's USB port.

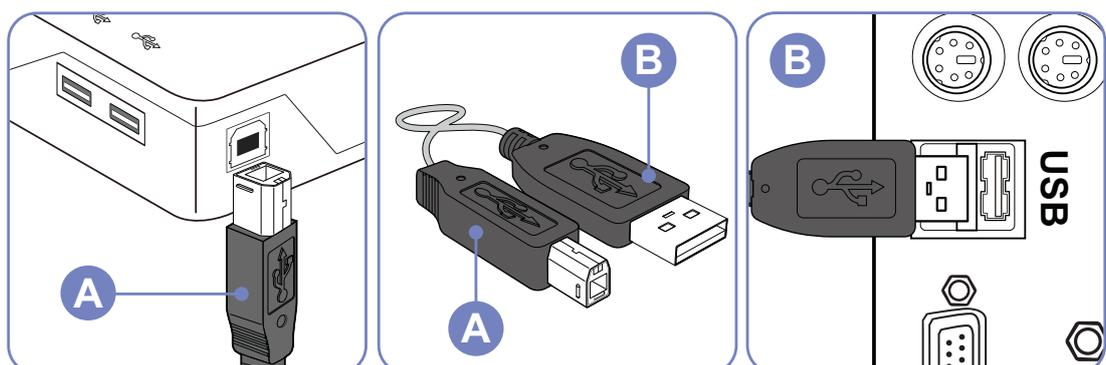

- 2 Connect the [] port of the USB monitor and a USB device with the USB cable.
 - 3 The use procedures are as the same as those for using an external device connecting to the PC.
 - You can connect and use a keyboard and mouse.
 - You can play a file from a media device. (Examples of media devices: MP3, digital camera, etc.)
 - You can run, move, copy or delete the files on the storage device. (Examples of storage devices: external memory, memory card, memory reader, HDD-type MP3 player, etc.)
 - You can use other USB devices that can be connected to a computer.
-  • When connecting a device to the [] port of the monitor, connect the device using a cable appropriate to the device.
- For the purchase of the cable and external devices, ask the service center of the corresponding product.
 - The company is not liable for problems or damages to an external device caused by using an unauthorized cable for the connection.
 - Some products do not follow the USB standard, and it may cause a malfunction of the device.
 - If the device malfunctions even if it is connected to the computer, contact the service center of the device/computer.

Changing the sound settings on Windows (S**E450M* Models)

Control Panel → Audio → Speaker → Speaker Setup

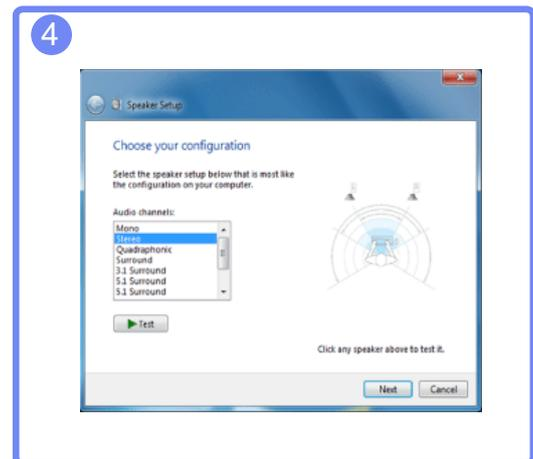
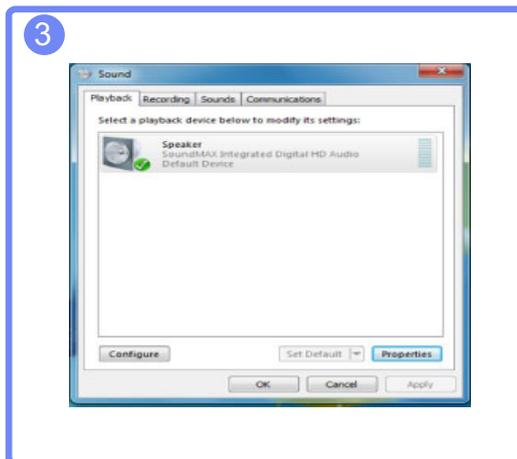
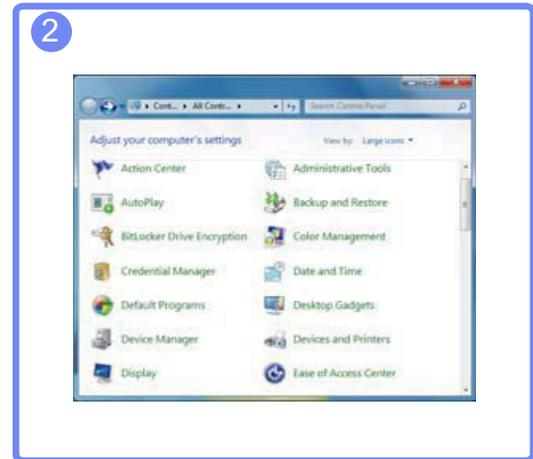

2.2.3 Driver Installation



- You can set the optimum resolution and frequency for this product by installing the corresponding drivers.
- An installation driver is contained on the CD supplied with the product.
- If the file provided is faulty, visit the Samsung homepage (<http://www.samsung.com>) and download the file.

- 1 Insert the user manual CD provided with the product into the CD-ROM drive.
- 2 Click "Windows Driver".
- 3 Follow the instructions given on the screen to proceed with installation.
- 4 Select your product model from the list of models.

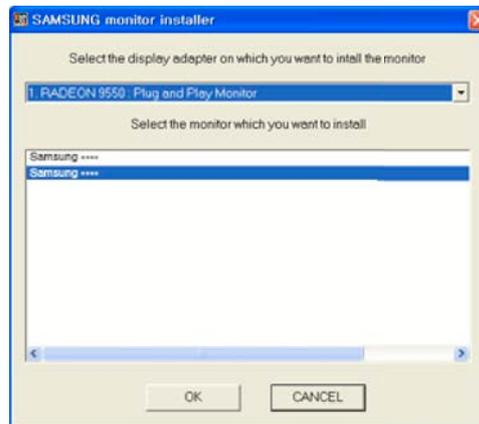

- 5 Go to Display Properties and check that the resolution and refresh rate are appropriate. Refer to your Windows OS manual for further details.

2.2.4 Setting Optimum Resolution

An information message about setting optimum resolution will appear if you power on the product for the first time after purchase.

Select a language on the product and change the resolution on your PC to the optimum setting.

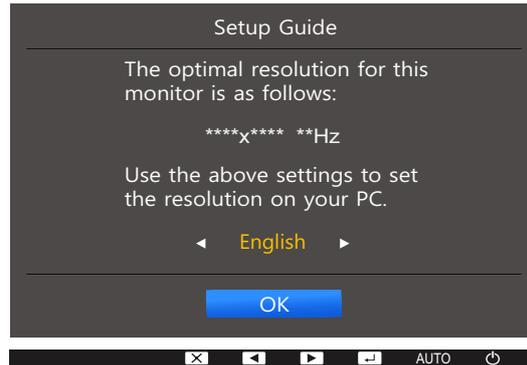

- 1 Press [**▲**/**▼**] to move to the language you want and press [**□**/**⏏**].
- 2 To hide the information message, press [**MENU**].



- If the optimum resolution is not selected, the message will appear up to three times for a specified time even when the product is turned off and on again.
- The optimum resolution can also be selected in **Control Panel** on your PC.

3

Screen Setup

A detailed description of each function is provided. Refer to your product for details.

Configure the screen settings such as brightness.

3.1 Brightness

You can adjust the general brightness of the picture. (Range: 0~100)

A higher value will make the picture appear brighter.



- This menu is not available when **SAMSUNG MAGICBright** is set to **Dynamic Contrast** mode.
- This menu is not available when **Smart Eco Saving** is set.
- This menu is not available when **Eye Saver Mode** is enabled.
- The functions available on the monitor may vary depending on the model. Refer to the actual product.

3.1.1 Configuring Brightness

- 1 Press any button on the front of the product to display the Key Guide. Next, press [MENU] to display the corresponding menu screen.
- 2 Press [▲/▼] to move to **PICTURE** and press [□/⊞] on the product.
- 3 Press [▲/▼] to move to **Brightness** and press [□/⊞] on the product.

The following screen will appear.

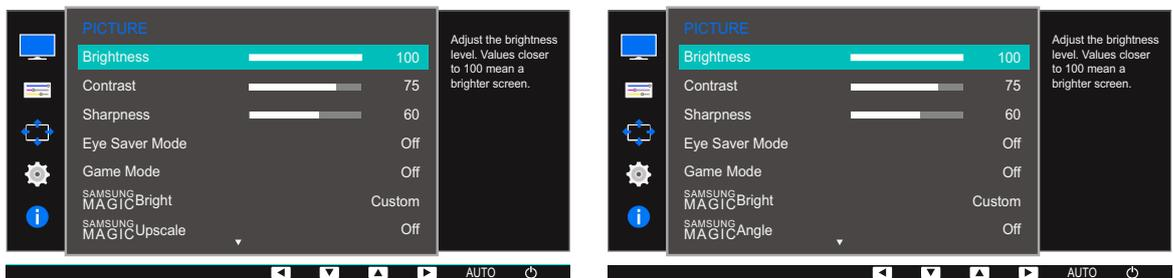

- 4 Adjust the **Brightness** using the [▲/▼] buttons.

3.2 Contrast

Adjust the contrast between the objects and background. (Range: 0~100)

A higher value will increase the contrast to make the object appear clearer.



- This menu is not available when **SAMSUNG MAGICBright** is in **Cinema** or **Dynamic Contrast** mode.
- This menu is not available when **Game Mode** is enabled.
- The functions available on the monitor may vary depending on the model. Refer to the actual product.

3.2.1 Configuring Contrast

- 1 Press any button on the front of the product to display the Key Guide. Next, press [MENU] to display the corresponding menu screen.
- 2 Press [▲/▼] to move to **PICTURE** and press [□/⏏] on the product.
- 3 Press [▲/▼] to move to **Contrast** and press [□/⏏] on the product.

The following screen will appear.

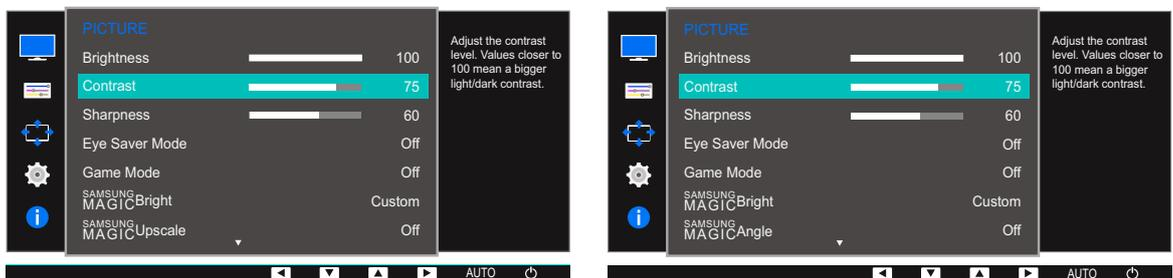

- 4 Adjust the **Contrast** using the [▲/▼] buttons.

3.3 Sharpness

Make the outline of objects more clear or blurry. (Range: 0~100)

A higher value will make the outline of objects clearer.



- This menu is not available when **SAMSUNG MAGICBright** is in **Cinema** or **Dynamic Contrast** mode.
- This menu is not available when **SAMSUNG MAGICUpscale** is in **Mode1** or **Mode2**.
- This menu is not available when **Game Mode** is enabled.
- The functions available on the monitor may vary depending on the model. Refer to the actual product.

3.3.1 Configuring Sharpness

- 1 Press any button on the front of the product to display the Key Guide. Next, press [MENU] to display the corresponding menu screen.
- 2 Press [▲/▼] to move to **PICTURE** and press [↔/☒] on the product.
- 3 Press [▲/▼] to move to **Sharpness** and press [↔/☒] on the product.
The following screen will appear.

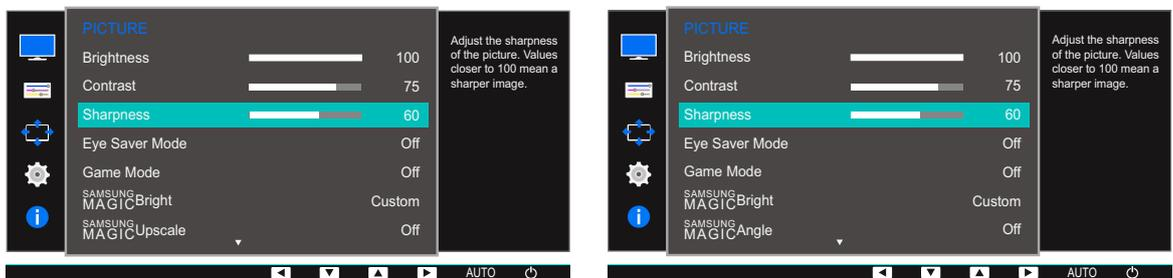

- 4 Adjust the **Sharpness** using the [▲/▼] buttons.

3.4 Eye Saver Mode

Set to an optimum picture quality suitable for eye relaxation.

TÜV Rheinland “Low Blue Light Content” is a certification for products which meet requirements for lower blue light levels. When **Eye Saver Mode** is 'On', the blue light that wavelength is around 400nm will decrease, and it will provide an optimum picture quality suitable for eye relaxation. At the same time, the blue light level is lower than in the default settings, and it was tested by TÜV Rheinland and certified as it met the requirements of TÜV Rheinland “Low Blue Light Content” standards. standards.



The functions available on the monitor may vary depending on the model. Refer to the actual product.

3.4.1 Configuring Eye Saver Mode

- 1 Press any button on the front of the product to display the Key Guide. Next, press **[MENU]** to display the corresponding menu screen.
- 2 Press **[▲/▼]** to move to **PICTURE** and press **[□/⊞]** on the product.
- 3 Press **[▲/▼]** to move to **Eye Saver Mode** and press **[□/⊞]** on the product.
The following screen will appear.

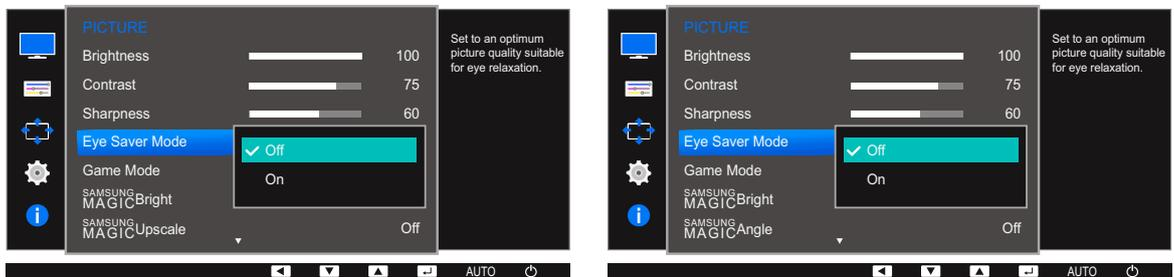

- 4 Press **[▲/▼]** to move to the option you want and press **[□/⊞]**.
- 5 The selected option will be applied.

3.5 Game Mode

Configure the product screen settings for game mode. Use this feature when playing games on a PC or when a game console such as PlayStation™ or Xbox™ is connected.



- This menu is not available when **Eye Saver Mode** or **Smart Eco Saving** is enabled.
- The functions available on the monitor may vary depending on the model. Refer to the actual product.

3.5.1 Configuring Game Mode

- 1 Press any button on the front of the product to display the Key Guide. Next, press [MENU] to display the corresponding menu screen.
- 2 Press [▲/▼] to move to **PICTURE** and press [□/⏏] on the product.
- 3 Press [▲/▼] to move to **Game Mode** and press [□/⏏] on the product.

The following screen will appear.

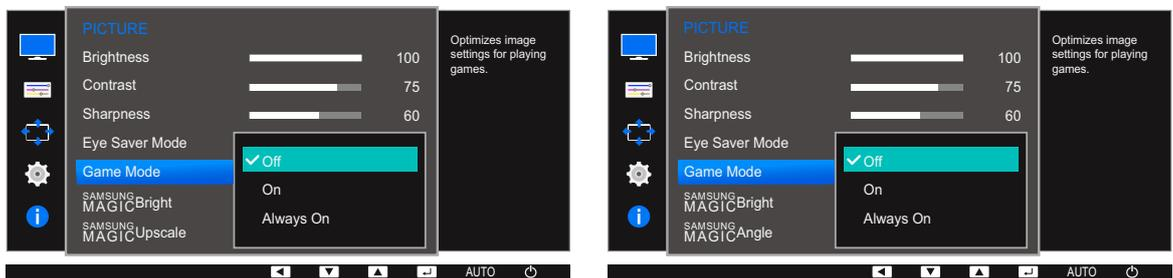

- 4 Press [▲/▼] to move to the option you want and press [□/⏏].
- 5 The selected option will be applied.



- When the monitor turns off, enters power-saving mode or changes input sources, **Game Mode** turns **Off** even if it is set to **On**.
- If you want to keep **Game Mode** enabled all the time, select **Always On**.

3.6 SAMSUNG MAGIC Bright

This menu provides an optimum picture quality suitable for the environment where the product will be used.

- This menu is not available when **Smart Eco Saving** is enabled.
- This menu is not available when **Game Mode** is enabled.
- This menu is not available when **Eye Saver Mode** is enabled.
- This menu is not available when **SAMSUNG MAGIC Angle** is enabled.
- The functions available on the monitor may vary depending on the model. Refer to the actual product.

You can customize the brightness to suit your preferences.

3.6.1 Configuring SAMSUNG MAGIC Bright

- 1 Press any button on the front of the product to display the Key Guide. Next, press [MENU] to display the corresponding menu screen.
- 2 Press [▲/▼] to move to **PICTURE** and press [□/⏏] on the product.
- 3 Press [▲/▼] to move to **SAMSUNG MAGIC Bright** and press [□/⏏] on the product.

The following screen will appear.

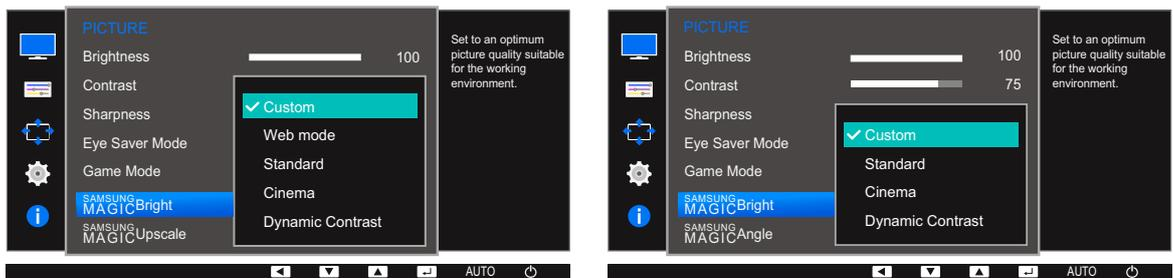

- **Custom:** Customize the contrast and brightness as required.
 - **Web mode:** Obtain the best screen for editing documents and browsing the Internet without the issue of narrow viewing angles. (S19E200NY, S22E200NY)
 - **Standard:** Obtain a picture quality suitable for editing documents or using Internet.
 - **Cinema:** Obtain the brightness and sharpness of TVs suitable for enjoying video and DVD content.
 - **Dynamic Contrast:** Obtain balanced brightness through automatic contrast adjustment.
- 4 Press [▲/▼] to move to the option you want and press [□/⏏].
 - 5 The selected option will be applied.

3.7 SAMSUNG MAGIC Angle (Except S19E200NY / S22E200NY / S24E650BW)

SAMSUNG MAGIC Angle allows you to configure the settings to obtain the optimum picture quality according to your viewing angle.



- This menu is not available when **SAMSUNG MAGIC Bright** is in **Cinema** or **Dynamic Contrast** mode.
- This menu is not available when **Game Mode** or **Eye Saver Mode** is enabled.
- The functions available on the monitor may vary depending on the model. Refer to the actual product.

You can customize the angle to suit your preferences.

3.7.1 Configuring SAMSUNG MAGIC Angle

- 1 Press any button on the front of the product to display the Key Guide. Next, press **[MENU]** to display the corresponding menu screen.
- 2 Press **[▲/▼]** to move to **PICTURE** and press **[□/⊞]** on the product.
- 3 Press **[▲/▼]** to move to **SAMSUNG MAGIC Angle** and press **[□/⊞]** on the product.
The following screen will appear.

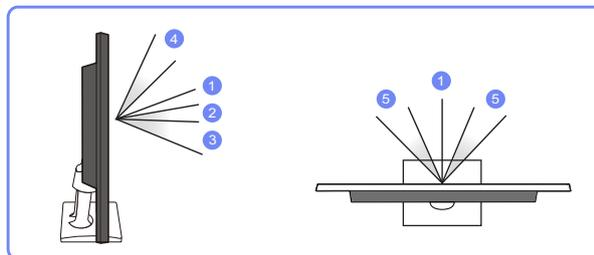
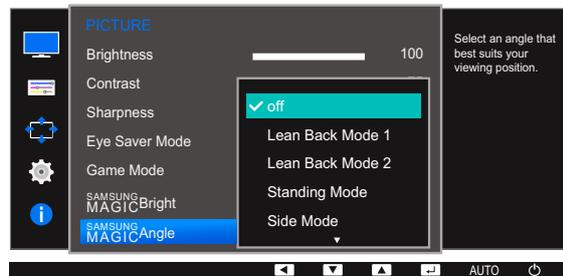

- **Off** ①: Select this option to view directly in front of the product.
- **Lean Back Mode 1** ②: Select this option to view from a place slightly lower than the product.
- **Lean Back Mode 2** ③: Select this option to view from a place lower than **Lean Back Mode 1**.
- **Standing Mode** ④: Select this option to view from a place higher than the product.
- **Side Mode** ⑤: Select this option to view from either side of the product.
- **Group View**: Select this option for more than one viewer to view from places ①, ④, and ⑤.

- **Custom: Lean Back Mode 1** will be applied by default if **Custom** is selected.
- 4 Press [▲/▼] to move to the option you want and press [□/⊞].
 - 5 The selected option will be applied.

3.8 SAMSUNG MAGIC Upscale

SAMSUNG MAGIC Upscale function can enhance the layers of the picture details and the vividness of the picture.



- The function has more obvious effects on low-resolution pictures.
- This menu is not available when **SAMSUNG MAGIC Bright** is in **Cinema** or **Dynamic Contrast** mode.
- This menu is not available when **Game Mode** is enabled.
- The functions available on the monitor may vary depending on the model. Refer to the actual product.

3.8.1 Configuring SAMSUNG MAGIC Upscale

- 1 Press any button on the front of the product to display the Key Guide. Next, press [MENU] to display the corresponding menu screen.
- 2 Press [▲/▼] to move to **PICTURE** and press [□/⊞] on the product.
- 3 Press [▲/▼] to move to **SAMSUNG MAGIC Upscale** and press [□/⊞] on the product. The following screen will appear.

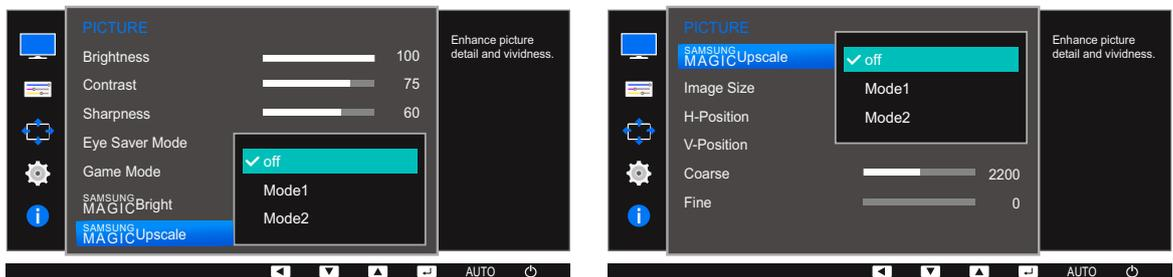

Comparing with **Mode1**, **Mode2** has a stronger effect.

- 4 Press [▲/▼] to move to the option you want and press [□/⊞].
- 5 The selected option will be applied.

3.9 Image Size (Except S19E200BR / S19E450BR / S19E450MR)

Change the picture size.



The functions available on the monitor may vary depending on the model. Refer to the actual product.

3.9.1 Changing the Image Size

- 1 Press any button on the front of the product to display the Key Guide. Next, press [MENU] to display the corresponding menu screen.
- 2 Press [▲/▼] to move to **PICTURE** and press [□/⊞] on the product.
- 3 Press [▲/▼] to move to **Image Size** and press [□/⊞] on the product. The following screen will appear.

In **PC** mode

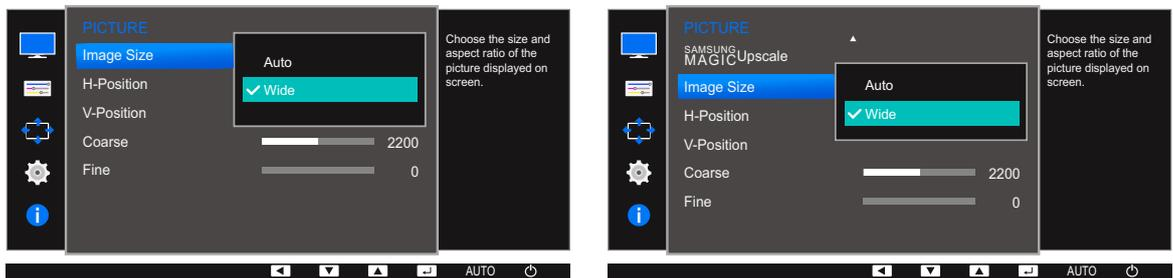

- **Auto:** Display the picture according to the aspect ratio of the input source.
- **Wide:** Display the picture in full screen regardless of the aspect ratio of the input source.

In **AV** mode

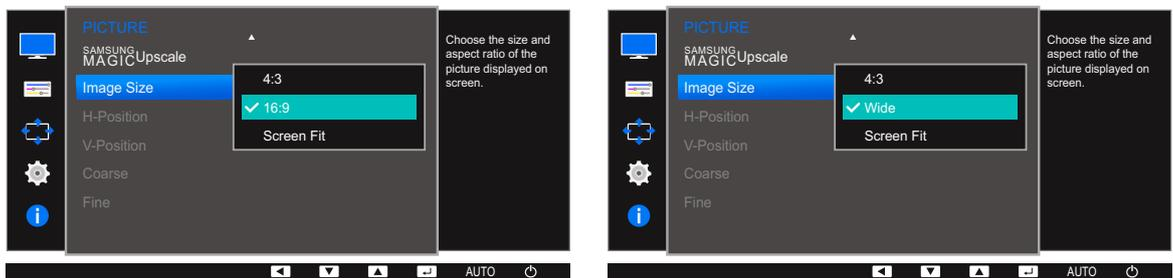

- **4:3:** Display the picture with an aspect ratio of 4:3. Suitable for videos and standard broadcasts.
- **16:9:** Display the picture with an aspect ratio of 16:9.
- **Screen Fit:** Display the picture with the original aspect ratio without cutting off.
- **Wide:** Display the picture in full screen regardless of the aspect ratio of the input source.
(S19E200NW, S19E200BW, S22E200BW, S19E450BW, S19E450MW, S22E450BW, S22E450MW, S22E450DW)



Changing the screen size is available when the following conditions are satisfied.

- A digital output device is connected using the DVI/DP cable.
- The input signal is 480p, 576p, 720p, or 1080p and monitor can display normally (not every model can support all of these signals).
- This can only be set when the external input is connected through DVI and **PC/AV Mode** is set to **AV**.

4 Press [**▲**/**▼**] to move to the option you want and press [**□**/**⏏**].

5 The selected option will be applied.

3.10 Response Time (S24E650BW)

Accelerate the panel response rate to make video appear more vivid and natural.



- It is best to set **Response Time** to **Standard** or **Faster** when you are not viewing a movie.
- The functions available on the monitor may vary depending on the model. Refer to the actual product.

3.10.1 Configuring the Response Time

- 1 Press any button on the front of the product to display the Key Guide. Next, press [MENU] to display the corresponding menu screen.
- 2 Press [▲/▼] to move to **PICTURE** and press [□/⊞] on the product.
- 3 Press [▲/▼] to move to **Response Time** and press [□/⊞] on the product. The following screen will appear.

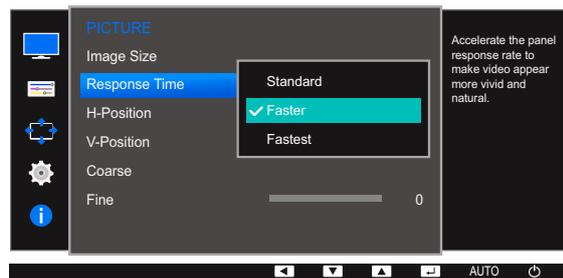

- 4 Press [▲/▼] to move to the option you want and press [□/⊞].
- 5 The selected option will be applied.

3.11 H-Position & V-Position

H-Position: Move the screen to the left or right.

V-Position: Move the screen up or down.



- This menu is available in **Analog** mode.
- This menu is only available when **Image Size** is set to **Screen Fit** in **AV** Mode. When a 480P or 576P or 720P or 1080P signal is input in **AV** mode and the monitor can display normally, select **Screen Fit** to adjust horizontal position in 0-6 levels.
- The functions available on the monitor may vary depending on the model. Refer to the actual product.

3.11.1 Configuring H-Position & V-Position

- 1 Press any button on the front of the product to display the Key Guide. Next, press [MENU] to display the corresponding menu screen.
- 2 Press [▲/▼] to move to **PICTURE** and press [□/⊞] on the product.
- 3 Press [▲/▼] to move to **H-Position** or **V-Position**, and press [□/⊞]. The following screen will appear.

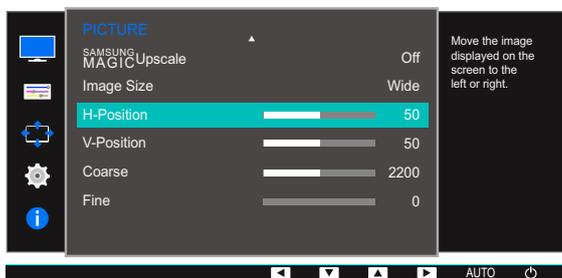
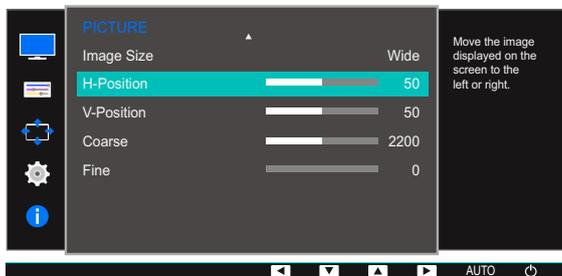

- 4 Press [▲/▼] to configure **H-Position** or **V-Position**.

3.12 Coarse

Adjust the screen frequency.



- This menu is available in **Analog** mode only.
- The functions available on the monitor may vary depending on the model. Refer to the actual product.

3.12.1 Adjusting Coarse

- 1 Press any button on the front of the product to display the Key Guide. Next, press [MENU] to display the corresponding menu screen.
- 2 Press [▲/▼] to move to **PICTURE** and press [□/⊞] on the product.
- 3 Press [▲/▼] to move to **Coarse** and press [□/⊞] on the product. The following screen will appear.

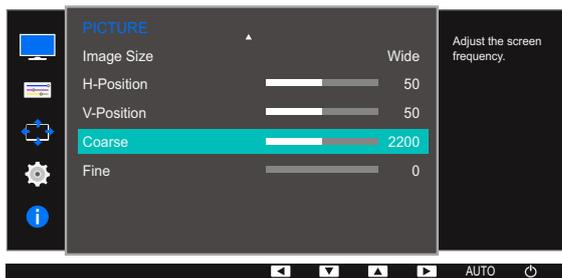

- 4 Adjust the **Coarse** using the [▲/▼] buttons.

3.13 Fine

Fine-adjust the screen to obtain a vivid picture.



- This menu is available in **Analog** mode only.
- The functions available on the monitor may vary depending on the model. Refer to the actual product.

3.13.1 Adjusting Fine

- 1 Press any button on the front of the product to display the Key Guide. Next, press [MENU] to display the corresponding menu screen.
- 2 Press [▲/▼] to move to **PICTURE** and press [□/⊞] on the product.
- 3 Press [▲/▼] to move to **Fine** and press [□/⊞] on the product. The following screen will appear.

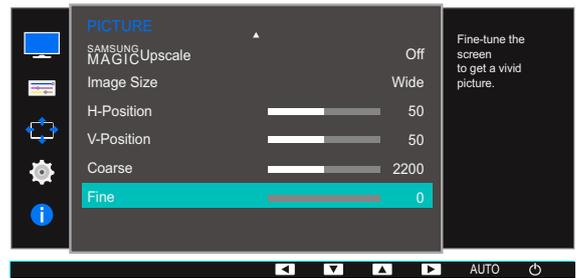

- 4 Adjust the **Fine** using the [▲/▼] buttons.

4

Configuring Tint

A detailed description of each function is provided. Refer to your product for details.

Adjust the tint of the screen. This menu is not available when **SAMSUNG MAGICBright** is in **Cinema** or **Web mode**, **Dynamic Contrast** mode. This menu is not available when **Game Mode** or **Eye Saver Mode** is enabled.

4.1 Red

Adjust the value of the color red in the picture. (Range: 0~100)

A higher value will increase the intensity of the color.

4.1.1 Configuring Red

- 1 Press any button on the front of the product to display the Key Guide. Next, press [MENU] to display the corresponding menu screen.
- 2 Press [▲/▼] to move to **COLOR** and press [↶/↷] on the product.
- 3 Press [▲/▼] to move to **Red** and press [↶/↷] on the product.

The following screen will appear.

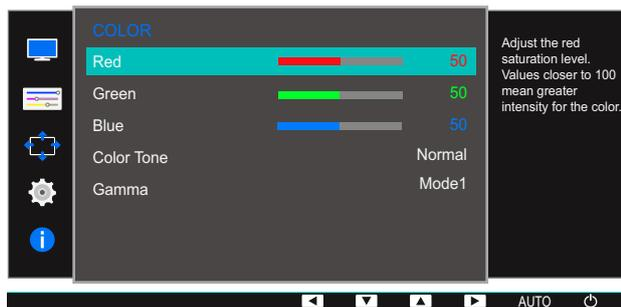

- 4 Adjust the **Red** using the [▲/▼] buttons.

4.2 Green

Adjust the value of the color green in the picture. (Range: 0~100)

A higher value will increase the intensity of the color.

4.2.1 Configuring Green

- 1 Press any button on the front of the product to display the Key Guide. Next, press [MENU] to display the corresponding menu screen.
- 2 Press [▲/▼] to move to **COLOR** and press [⏪/⏩] on the product.
- 3 Press [▲/▼] to move to **Green** and press [⏪/⏩] on the product.

The following screen will appear.

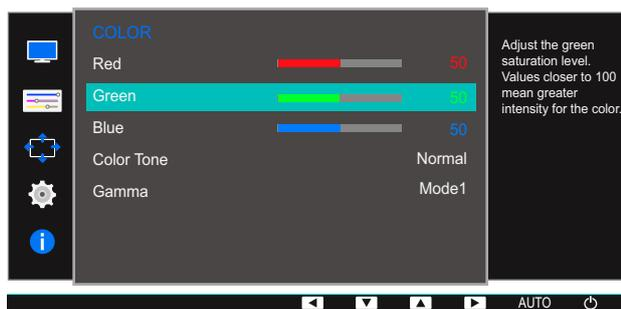

- 4 Adjust the **Green** using the [▲/▼] buttons.

4.3 Blue

Adjust the value of the color blue in the picture. (Range: 0~100)

A higher value will increase the intensity of the color.

4.3.1 Configuring Blue

- 1 Press any button on the front of the product to display the Key Guide. Next, press [MENU] to display the corresponding menu screen.
- 2 Press [▲/▼] to move to **COLOR** and press [□/⊞] on the product.
- 3 Press [▲/▼] to move to **Blue** and press [□/⊞] on the product.

The following screen will appear.

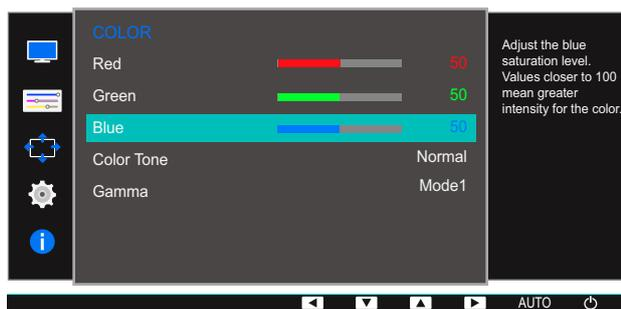

- 4 Adjust the **Blue** using the [▲/▼] buttons.

4.4 Color Tone

Adjust the general color tone of the picture.



This menu is not available when **SAMSUNG MAGIC Angle** is enabled.

4.4.1 Configuring the Color Tone Settings

- 1 Press any button on the front of the product to display the Key Guide. Next, press [MENU] to display the corresponding menu screen.
- 2 Press [▲/▼] to move to **COLOR** and press [□/⊞] on the product.
- 3 Press [▲/▼] to move to **Color Tone** and press [□/⊞] on the product.

The following screen will appear.

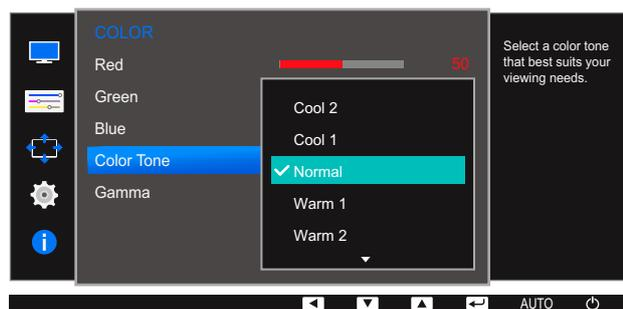

- **Cool 2**: Set the color temperature to be cooler than **Cool 1**.
 - **Cool 1**: Set the color temperature to be cooler than **Normal** mode.
 - **Normal**: Display the standard color tone.
 - **Warm 1**: Set the color temperature to be warmer than **Normal** mode.
 - **Warm 2**: Set the color temperature to be warmer than **Warm 1**.
 - **Custom** : Customize the color tone.
- 4 Press [▲/▼] to move to the option you want and press [□/⊞].
 - 5 The selected option will be applied.

4.5 Gamma

Adjust the mid-range brightness (Gamma) of the picture.

 This menu is not available when **SAMSUNG MAGIC Angle** is enabled.

4.5.1 Configuring Gamma

- 1 Press any button on the front of the product to display the Key Guide. Next, press [MENU] to display the corresponding menu screen.
- 2 Press [▲/▼] to move to **COLOR** and press [□/□] on the product.
- 3 Press [▲/▼] to move to **Gamma** and press [□/□] on the product.

The following screen will appear.

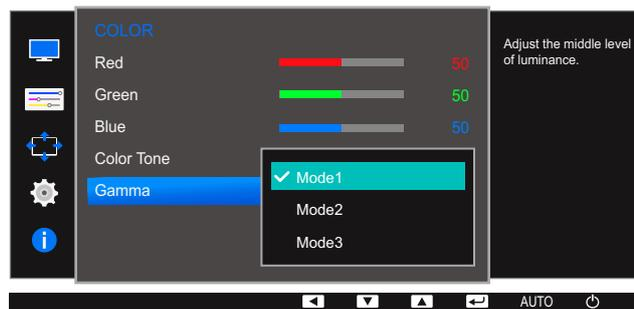

- 4 Press [▲/▼] to move to the option you want and press [□/□].
- 5 The selected option will be applied.

Resizing or Relocating the Screen

A detailed description of each function is provided. Refer to your product for details.

5.1 Language

Set the menu language.



- A change to the language setting will only be applied to the onscreen menu display.
- It will not be applied to other functions on your PC.

5.1.1 Changing the Language

- 1 Press any button on the front of the product to display the Key Guide. Next, press [MENU] to display the corresponding menu screen.
- 2 Press [▲/▼] to move to **MENU SETTINGS** and press [□/↔] on the product.
- 3 Press [▲/▼] to move to **Language** and press [□/↔] on the product.

The following screen will appear.

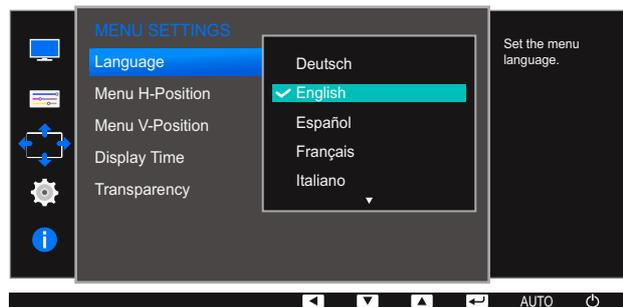

- 4 Press [▲/▼] to move to the language you want and press [□/↔].
- 5 The selected option will be applied.

5.2 Menu H-Position & Menu V-Position

Menu H-Position: Move the menu position to the left or right.

Menu V-Position: Move the menu position up or down.

5.2.1 Configuring Menu H-Position & Menu V-Position

- 1 Press any button on the front of the product to display the Key Guide. Next, press [MENU] to display the corresponding menu screen.
- 2 Press [▲/▼] to move to **MENU SETTINGS** and press [□/⇄] on the product.
- 3 Press [▲/▼] to move to **Menu H-Position** or **Menu V-Position**, and press [□/⇄].

The following screen will appear.

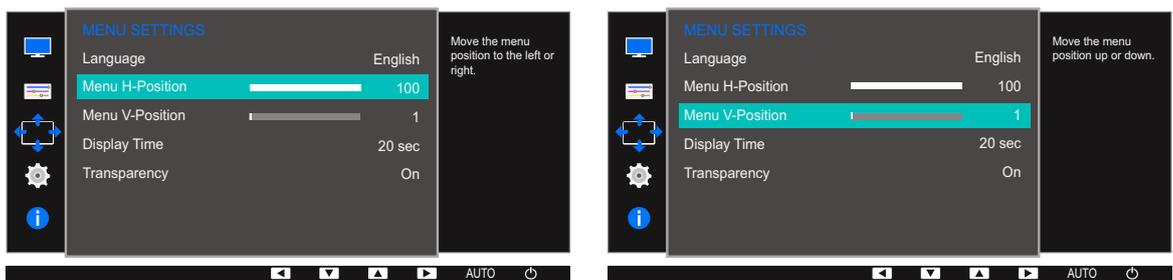

- 4 Press [▲/▼] to configure **Menu H-Position** or **Menu V-Position**.

5.3 Display Time

Set the on-screen display (OSD) menu to automatically disappear if the menu is not used for a specified period of time.

Display Time can be used to specify the time after which you want the OSD menu to disappear.

5.3.1 Configuring Display Time

- 1 Press any button on the front of the product to display the Key Guide. Next, press **[MENU]** to display the corresponding menu screen.
- 2 Press **[▲/▼]** to move to **MENU SETTINGS** and press **[□/⏏]** on the product.
- 3 Press **[▲/▼]** to move to **Display Time** and press **[□/⏏]** on the product.

The following screen will appear.

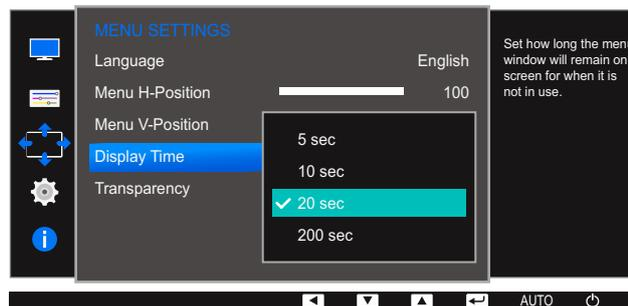

- 4 Press **[▲/▼]** to move to the option you want and press **[□/⏏]**.
- 5 The selected option will be applied.

5.4 Transparency

Set the transparency for the menu windows.

5.4.1 Changing Transparency

- 1 Press any button on the front of the product to display the Key Guide. Next, press [MENU] to display the corresponding menu screen.
- 2 Press [▲/▼] to move to **MENU SETTINGS** and press [□/↔] on the product.
- 3 Press [▲/▼] to move to **Transparency** and press [□/↔] on the product.
The following screen will appear.

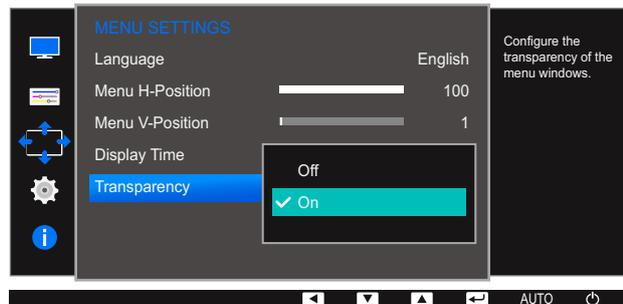

- 4 Press [▲/▼] to move to the option you want and press [□/↔].
- 5 The selected option will be applied.

A detailed description of each function is provided. Refer to your product for details.

6.1 Reset All

Return all the settings for the product to the default factory settings.



The functions available on the monitor may vary depending on the model. Refer to the actual product.

6.1.1 Initializing Settings (Reset All)

- 1 Press any button on the front of the product to display the Key Guide. Next, press [MENU] to display the corresponding menu screen.
- 2 Press [▲/▼] to move to **SETUP&RESET** and press [↵/⏏] on the product.
- 3 Press [▲/▼] to move to **Reset All** and press [↵/⏏] on the product.

The following screen will appear.

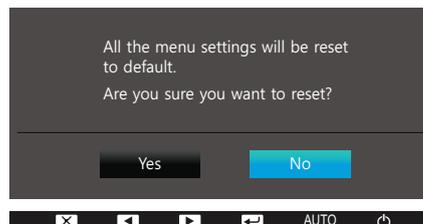
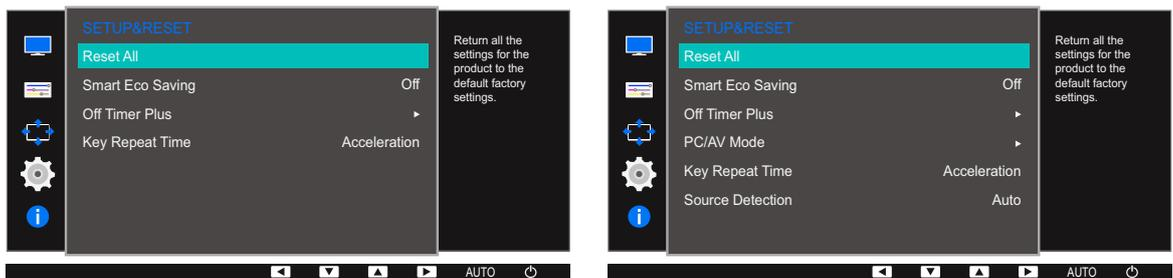

- 4 Press [▲/▼] to move to the option you want and press [↵/⏏].
- 5 The selected option will be applied.

6.2 Smart Eco Saving

The **Smart Eco Saving** function reduces power consumption by controlling the electric current used by the monitor panel.



- This menu is not available when **Eye Saver Mode** is enabled.
- **Game Mode** will automatically turn off when **Smart Eco Saving** is enabled.
- **Dynamic Contrast** mode is not available when **Smart Eco Saving** is enabled.
- The functions available on the monitor may vary depending on the model. Refer to the actual product.

6.2.1 Configuring Smart Eco Saving

- 1 Press any button on the front of the product to display the Key Guide. Next, press [MENU] to display the corresponding menu screen.
- 2 Press [▲/▼] to move to **SETUP&RESET** and press [□/☞] on the product.
- 3 Press [▲/▼] to move to **Smart Eco Saving** and press [□/☞] on the product.

The following screen will appear.

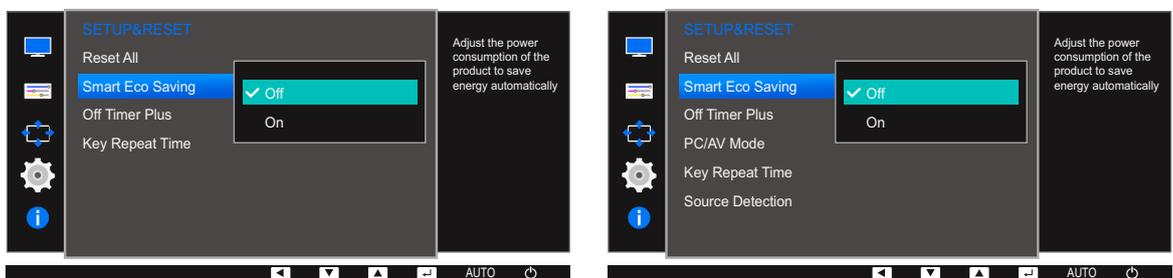

- **Off:** Deactivate the **Smart Eco Saving** function.
 - **On:** Allow the video to reduce the power consumption automatically by about 10% compared with the current setting.
(The reduction of power consumption depends on the customer screen brightness condition.)
- 4 Press [▲/▼] to move to the option you want and press [□/☞].
 - 5 The selected option will be applied.

6.3 Off Timer (S19E200NW / S19E200NY / S22E200N / S22E200NY)

You can set the product to automatically turn off.



The functions available on the monitor may vary depending on the model. Refer to the actual product.

6.3.1 Configuring Off Timer

- 1 Press any button on the front of the product to display the Key Guide. Next, press [MENU] to display the corresponding menu screen.
- 2 Press [▲/▼] to move to **SETUP&RESET** and press [⏪/⏩] on the product.
- 3 Press [▲/▼] to move to **Off Timer** and press [⏪/⏩] on the product.
- 4 Press [▲/▼] to move to **Off Timer** and press [⏪/⏩] on the product.

The following screen will appear.

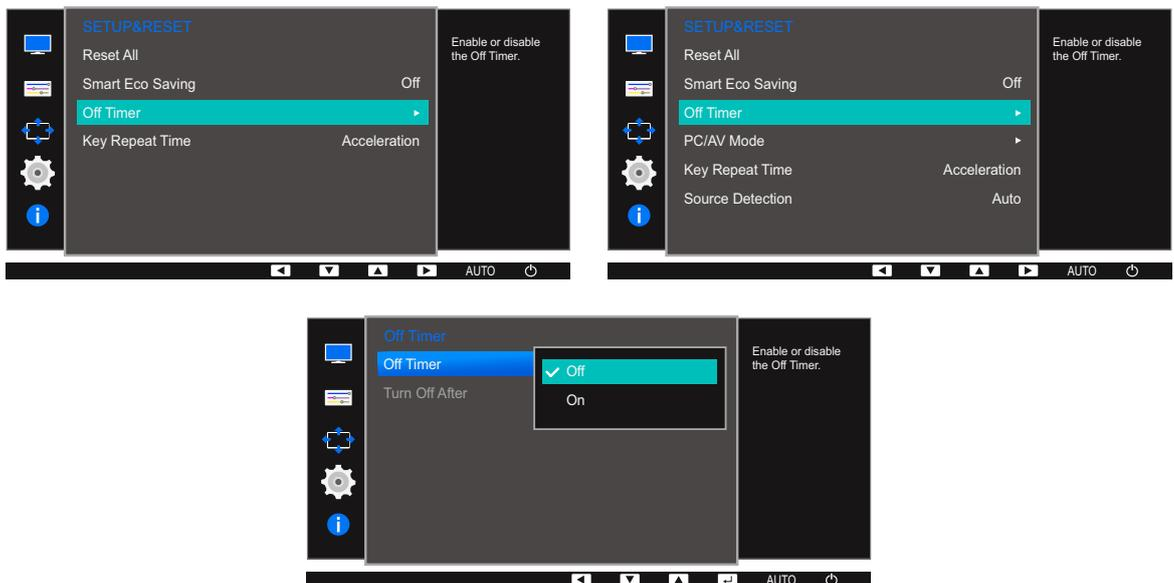

- **Off:** Deactivate the off timer so that the product does not power off automatically.
 - **On:** Activate the off timer so that the product powers off automatically.
- 5 Press [▲/▼] to move to the option you want and press [⏪/⏩].
 - 6 The selected option will be applied.

6.3.2 Configuring Turn Off After

- 1 Press any button on the front of the product to display the Key Guide. Next, press [MENU] to display the corresponding menu screen.
- 2 Press [▲/▼] to move to **SETUP&RESET** and press [□/☞] on the product.
- 3 Press [▲/▼] to move to **Off Timer** and press [□/☞] on the product.
- 4 Press [▲/▼] to move to **Turn Off After** and press [□/☞] on the product.

The following screen will appear.

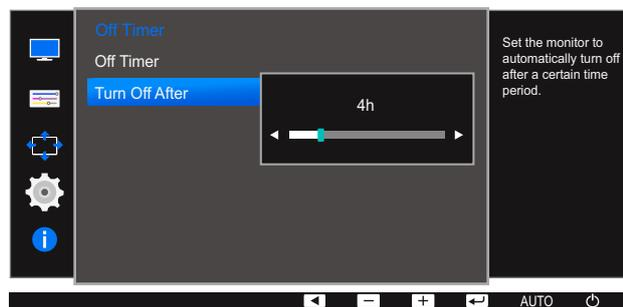

- 5 Press [▲/▼] to configure **Turn Off After**.



- The off timer can be set within a range of 1 to 23 hours. The product will automatically power off after the specified number of hours.
- This option is only available when **Off Timer** is set to **On**.
- For products for the market in some regions, the **Off Timer** is set to automatically activate 4 hours after the product powers on. This is done in accordance with power supply regulations. If you do not want the timer to activate, go to **MENU** → **SETUP&RESET** and set **Off Timer** to **Off**.

6.4 Off Timer Plus (Except S19E200NW / S19E200NY / S22E200N / S22E200NY)

You can set the product to automatically turn off.



The functions available on the monitor may vary depending on the model. Refer to the actual product.

6.4.1 Configuring Off Timer

Off Timer

- 1 Press any button on the front of the product to display the Key Guide. Next, press [MENU] to display the corresponding menu screen.
- 2 Press [▲/▼] to move to **SETUP&RESET** and press [↔/↔] on the product.
- 3 Press [▲/▼] to move to **Off Timer Plus** and press [↔/↔] on the product.
- 4 Press [▲/▼] to move to **Off Timer** and press [↔/↔] on the product.
- 5 Press [▲/▼] to move to **Off Timer** and press [↔/↔] on the product.

The following screen will appear.

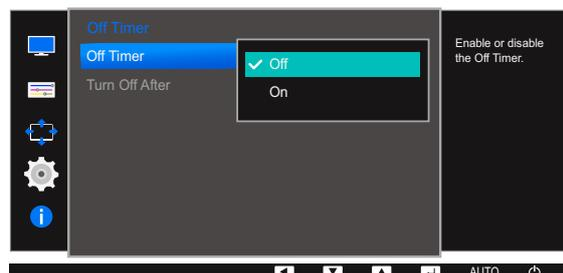
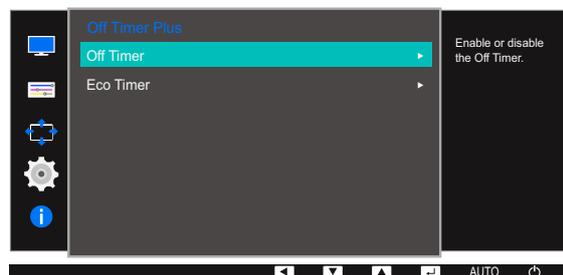
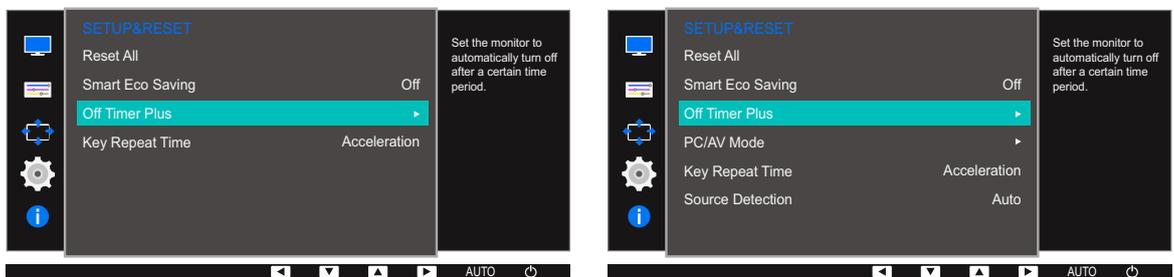

- **Off:** Deactivate the off timer so that the product does not power off automatically.
 - **On:** Activate the off timer so that the product powers off automatically.
- 6 Press [**▲/▼**] to move to the option you want and press [**□/⊞**].
 - 7 The selected option will be applied.

Turn Off After

- 1 Press any button on the front of the product to display the Key Guide. Next, press [**MENU**] to display the corresponding menu screen.
- 2 Press [**▲/▼**] to move to **SETUP&RESET** and press [**□/⊞**] on the product.
- 3 Press [**▲/▼**] to move to **Off Timer Plus** and press [**□/⊞**] on the product.
- 4 Press [**▲/▼**] to move to **Off Timer** and press [**□/⊞**] on the product.
- 5 Press [**▲/▼**] to move to **Turn Off After** and press [**□/⊞**] on the product.
The following screen will appear.

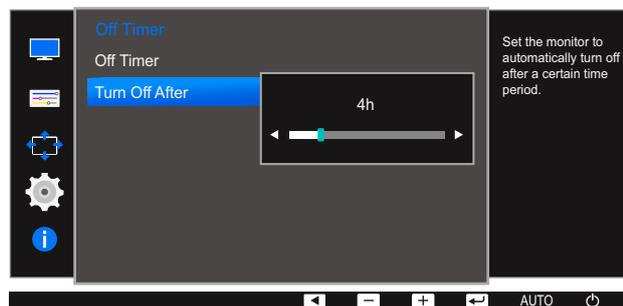

- 6 Press [**▲/▼**] to configure **Turn Off After**.
 - The off timer can be set within a range of 1 to 23 hours. The product will automatically power off after the specified number of hours.
 - This option is only available when **Off Timer** is set to **On**.
 - For products for the market in some regions, the **Off Timer** is set to automatically activate 4 hours after the product powers on. This is done in accordance with power supply regulations. If you do not want the timer to activate, go to **MENU** → **SETUP&RESET** → **Off Timer Plus** and set **Off Timer** to **Off**.

6.4.2 Configuring Eco Timer



This menu is not available for S19E200NY, S19E200NW, S22E200NY and S22E200N models.

Eco Timer

- 1 Press any button on the front of the product to display the Key Guide. Next, press [MENU] to display the corresponding menu screen.
- 2 Press [▲/▼] to move to **SETUP&RESET** and press [□/⏏] on the product.
- 3 Press [▲/▼] to move to **Off Timer Plus** and press [□/⏏] on the product.
- 4 Press [▲/▼] to move to **Eco Timer** and press [□/⏏] on the product.
- 5 Press [▲/▼] to move to **Eco Timer** and press [□/⏏] on the product.

The following screen will appear.

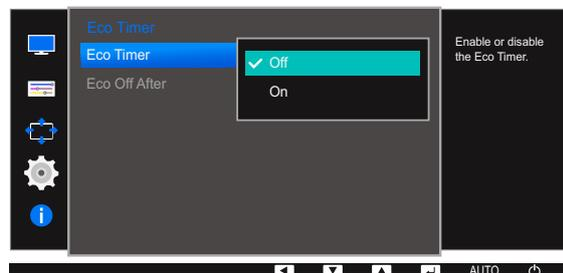
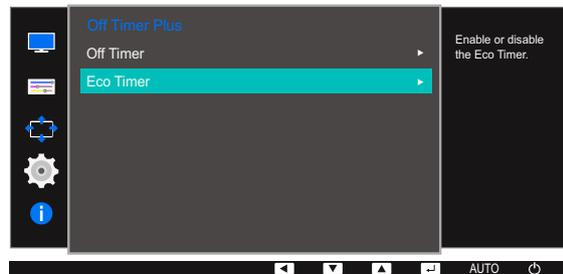
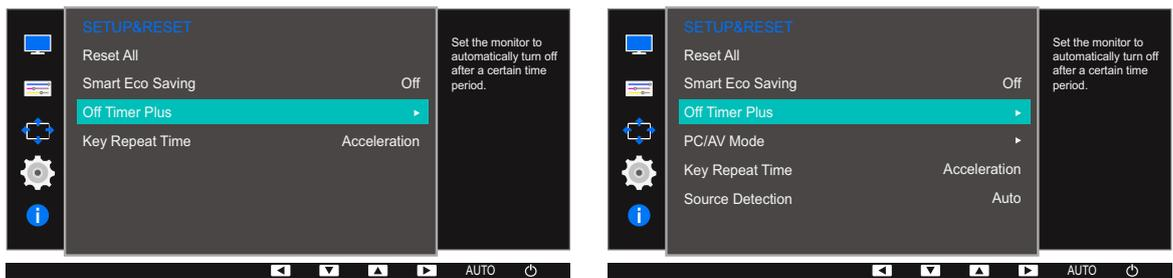

- **Off:** Deactivate the eco timer to disable the automatic power off feature. The product will not power off while in power-saving mode if this feature is deactivated.
- **On:** Activate the eco timer so that the product powers off automatically when it has been in power-saving mode for a specified period of time.

- 6 Press [▲/▼] to move to the option you want and press [□/⏏].
- 7 The selected option will be applied.

Eco Off After

- 1 Press any button on the front of the product to display the Key Guide. Next, press [MENU] to display the corresponding menu screen.
- 2 Press [▲/▼] to move to **SETUP&RESET** and press [↩/↪] on the product.
- 3 Press [▲/▼] to move to **Off Timer Plus** and press [↩/↪] on the product.
- 4 Press [▲/▼] to move to **Eco Timer** and press [↩/↪] on the product.
- 5 Press [▲/▼] to move to **Eco Off After** and press [↩/↪] on the product.

The following screen will appear.

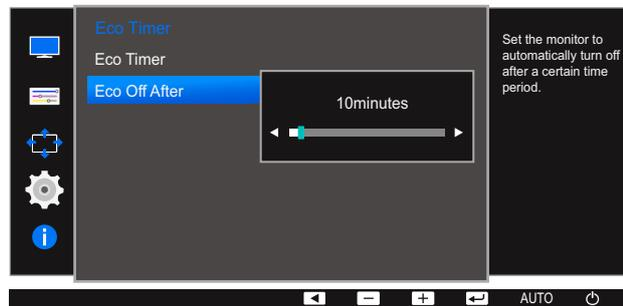

- 6 Press [▲/▼] to configure **Eco Off After**.



- The Eco timer can be set between 10 and 180 minutes. The product will automatically power off after the specified time has elapsed.
- This option is only available when **Eco Timer** is set to **On**.

6.5 PC/AV Mode (Except S19E200NW / S19E200NY / S22E200N / S22E200NY)

Set **PC/AV Mode** to **AV**. The picture size will be enlarged. This option is useful when you view a movie.



- This function does not support Analog mode.
- Supplied for the wide models only such as 16:9 or 16:10.
- If the monitor (when set to DVI) is in power saving mode or is displaying the message **Check Signal Cable**, press the [MENU] button to display the On Screen Display (OSD).
You can select **PC** or **AV**.
- The functions available on the monitor may vary depending on the model. Refer to the actual product.

6.5.1 Configuring PC/AV Mode

- 1 Press any button on the front of the product to display the Key Guide. Next, press [MENU] to display the corresponding menu screen.
- 2 Press [▲/▼] to move to **SETUP&RESET** and press [⏏/⏏] on the product.
- 3 Press [▲/▼] to move to **PC/AV Mode** and press [⏏/⏏] on the product.
The following screen will appear.

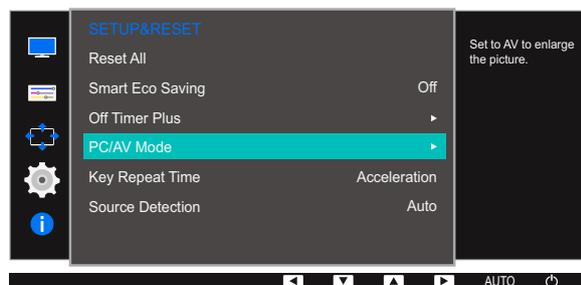

6

Setup and Reset

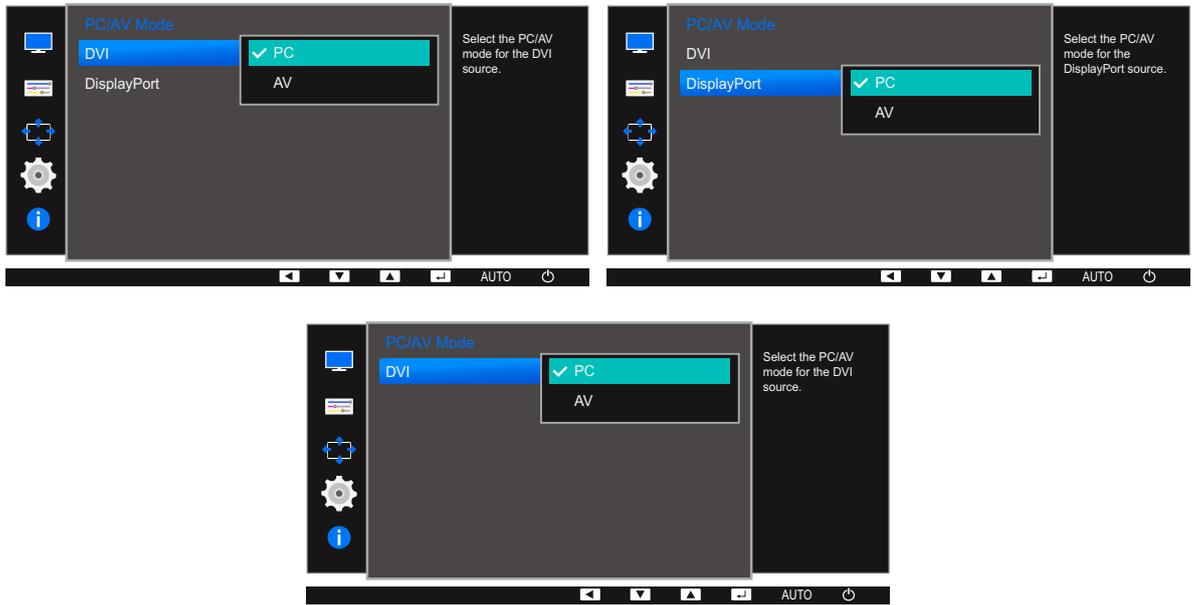

- 4 Press [\blacktriangle / \blacktriangledown] to move to the option you want and press [\square / \square].
- 5 The selected option will be applied.

6.6 Key Repeat Time

Control the response rate of a button when the button is pressed.



The functions available on the monitor may vary depending on the model. Refer to the actual product.

6.6.1 Configuring Key Repeat Time

- 1 Press any button on the front of the product to display the Key Guide. Next, press [MENU] to display the corresponding menu screen.
- 2 Press [▲/▼] to move to **SETUP&RESET** and press [□/⏏] on the product.
- 3 Press [▲/▼] to move to **Key Repeat Time** and press [□/⏏] on the product.

The following screen will appear.

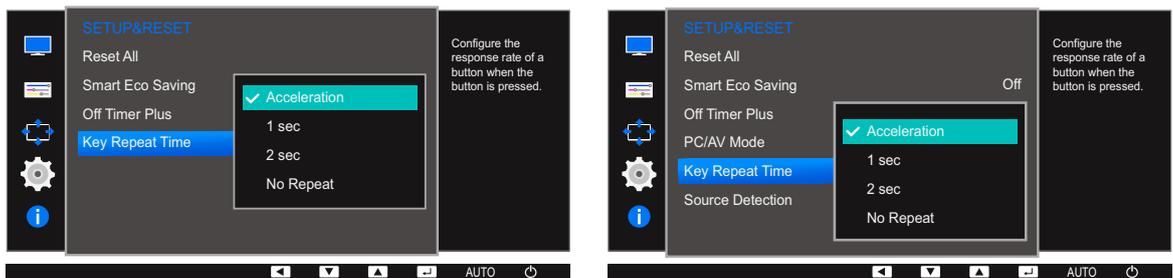

- **Acceleration, 1 sec, or 2 sec** can be selected. If **No Repeat** is selected, a command responds only once when a button is pressed.
- 4 Press [▲/▼] to move to the option you want and press [□/⏏].
 - 5 The selected option will be applied.

6.7 Source Detection (Except S19E200NW / S19E200NY / S22E200N / S22E200NY)

You can activate **Source Detection**.



The functions available on the monitor may vary depending on the model. Refer to the actual product.

6.7.1 Configuring Source Detection

- 1 Press any button on the front of the product to display the Key Guide. Next, press [MENU] to display the corresponding menu screen.
- 2 Press [▲/▼] to move to **SETUP&RESET** and press [□/⊞] on the product.
- 3 Press [▲/▼] to move to **Source Detection** and press [□/⊞] on the product.

The following screen will appear.

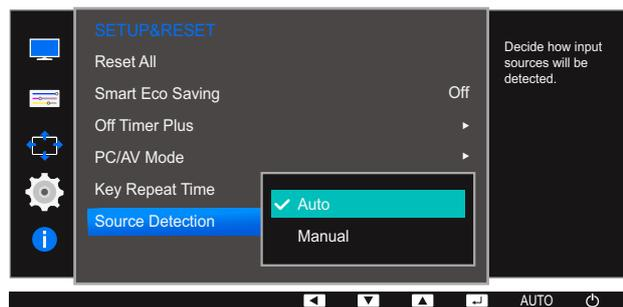

- **Auto**: The input source is automatically recognized.
 - **Manual**: Manually select an input source.
- 4 Press [▲/▼] to move to the option you want and press [□/⊞].
 - 5 The selected option will be applied.

A detailed description of each function is provided. Refer to your product for details.

7.1 INFORMATION

View the current input source, frequency and resolution.

7.1.1 Displaying INFORMATION

- 1 Press any button on the front of the product to display the Key Guide. Next, press [MENU] to display the corresponding menu screen.
- 2 Press [▲/▼] to move to **INFORMATION**. The current input source, frequency and resolution will appear.

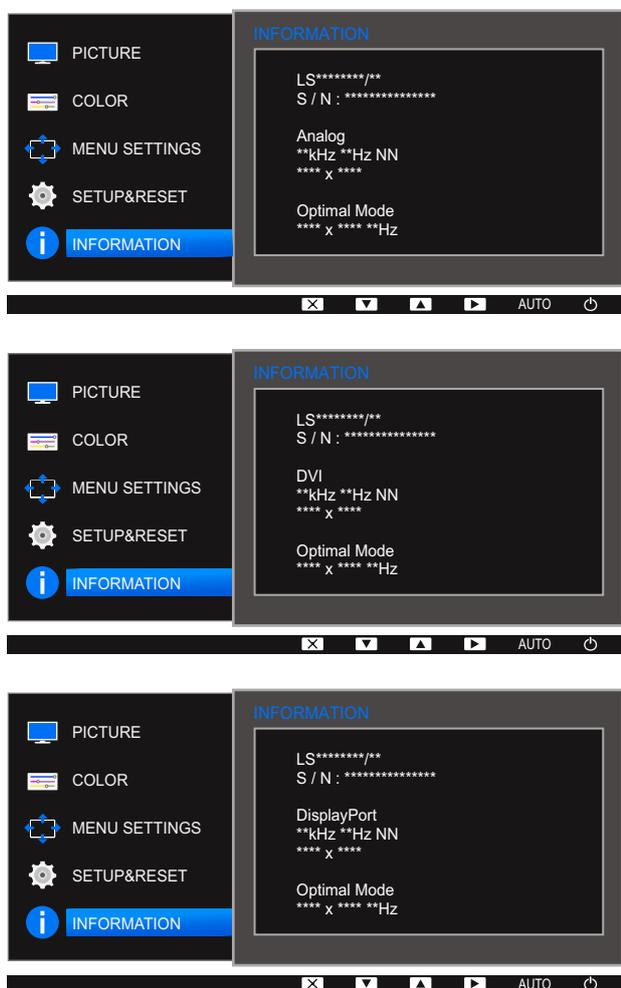

The displayed menu items may vary depending on the model.

7.2 Configuring Brightness, Contrast and Sharpness from the Initial Screen

Adjust the **Brightness**, **Contrast** and **Sharpness** setting using the [⊙] buttons in the initial screen (where no OSD menu is displayed).



Brightness :

- This menu is not available when **SAMSUNG MAGICBright** is set to **Dynamic Contrast** mode.
- This menu is not available when **Smart Eco Saving** is enabled.
- This menu is not available when **Eye Saver Mode** is enabled.



Contrast :

- This option is not available when **SAMSUNG MAGICBright** is in **Cinema** or **Dynamic Contrast** mode.
- This menu is not available when **Game Mode** is enabled.



Sharpness :

- This option is not available when **SAMSUNG MAGICBright** is in **Cinema** or **Dynamic Contrast** mode.
- This menu is not available when **Game Mode** is enabled.

- 1 Press any button on the front of the product (when no menu screen is displayed) to display the Key guide. Next, press the [⊙] button. The following screen will appear.



- 2 Press the [□/⊞] button to alternate between the **Brightness**, **Contrast** and **Sharpness** settings.
- 3 Adjust the **Brightness**, **Contrast** and **Sharpness** settings using the [▲/▼] buttons.

7.3 Configuring Volume in the Initial Screen

Adjust the **Volume** by pressing the [⊙] button when the Key Guide is displayed.

- 1 Press any button on the front of the product (when no menu screen is displayed) to display the Key guide. Next, press [⊙]. The following screen will appear.



- 2 Adjust the **Volume** setting using the [▲/▼] buttons.



- Applicable to the models that have speakers only.
- **Volume** can be adjusted if a cable is connected to the [IN] port.

8.1 MultiScreen



"MultiScreen" enables users to use the monitor by partitioning multiple sections.

8.1.1 Installing the Software

- 1 Insert the installation CD into the CD-ROM drive.
- 2 Select the "MultiScreen" setup program.
 -  If the pop-up screen for the software installation does not appear on the main screen, find and double-click the "MultiScreen" setup file on the CD-ROM.
- 3 When the Installation Wizard appears, click "Next".
- 4 Complete the remaining software installation steps according to the instructions displayed on the screen.
 - 
 - The software may not work properly if you do not restart the computer after the installation.
 - The "MultiScreen" icon may not appear depending on the computer system and the product specifications.
 - If the shortcut icon does not appear, press the F5 key.

Restrictions and Problems with the Installation ("MultiScreen")

The "MultiScreen" installation may be affected by the Graphics Card, Motherboard and the Networking Environment.

System Requirements

OS

- Windows™ 2000
- Windows XP Home Edition
- Windows XP Professional
- Windows Vista 32Bit
- Windows 7 32Bit
- Windows 8 32Bit

 For "MultiScreen", the operating systems Windows 2000 or later is recommended.

Hardware

- At least 32MB of memory
- At least 60MB of free space on the hard disk drive

8.1.2 Removing the Software

Click **Start**, select **Settings/Control Panel**, and then double-click **Add or Remove Programs**.

Select "MultiScreen" from the program list and click the **Add/Delete** button.

9.1 Requirements Before Contacting Samsung Customer Service Center

9.1.1 Testing the Product



Before calling Samsung Customer Service Center, test your product as follows. If the problem persists, contact Samsung Customer Service Center.

Check if your product is operating normally by using the product test function.

If the screen is turned off and the power indicator blinks even though the product is properly connected to a PC, perform a self-diagnosis test.

- 1 Power off both the PC and product.
- 2 Disconnect the cables from the product.
- 3 Power on the product.
- 4 If the message **Check Signal Cable** appears, the product is working normally.



If the screen remains blank, check the PC system, video controller and cable.

9.1.2 Checking the Resolution and Frequency

For a mode that exceeds the supported resolution (refer to "10.15 Standard Signal Mode Table"), the message **Not Optimum Mode** will appear for a short time.

9.1.3 Check the following.

Installation issue (PC mode)

Issues	Solutions
The screen keeps switching on and off.	Check the cable connection between the product and PC, and ensure the connectors are locked. (Refer to "2.2 Connecting and Using a PC")

Screen issue

Issues	Solutions
The power LED is off. The screen will not switch on.	Check that the power cable is connected properly. (Refer to "2.2 Connecting and Using a PC")
The message Check Signal Cable appears.	Check that the cable is properly connected to the product. (Refer to "2.2 Connecting and Using a PC")
	Check that the device connected to the product is powered on.
Not Optimum Mode is displayed.	This message appears when the signal from the graphics card exceeds the maximum resolution or frequency for the product.
	Change the maximum resolution and frequency to suit the product performance, referring to Standard Signal Mode Table (page 132).
The images on the screen look distorted.	Check the cable connection to the product (Refer to "2.2 Connecting and Using a PC")
The screen is not clear. The screen is blurry.	Adjust Coarse (page 70) and Fine (page 71).
	Remove any accessories (video extension cable, etc.) and try again.
	Set the resolution and frequency to the recommended level.
The screen appears unstable and shaky.	Check that the resolution and frequency for the PC are within the range of resolution and frequency compatible with the product. Next, if required, change the settings, referring to Standard Signal Mode Table (page 132) in this manual and the INFORMATION menu on the product.
There are shadows or ghost images left on the screen.	
The screen is too bright. The screen is too dark.	Adjust Brightness (page 57) and Contrast (page 58).
Screen color is inconsistent.	Change the COLOR settings. (Refer to "Configuring Tint")
The colors on the screen have a shadow and are distorted.	Change the COLOR settings. (Refer to "Configuring Tint")
White does not really look white.	Change the COLOR settings. (Refer to "Configuring Tint")

Issues	Solutions
There is no image on the screen and the power LED blinks every 0.5 to 1 second.	The product is operating in power-saving mode.
	Press any key on the keyboard or move the mouse to return to normal operating mode.

Sound issue

Issues	Solutions
There is no sound.	Check the connection of the audio cable or adjust the volume.
	Check the volume.
The volume is too low.	Adjust the volume.
	If the volume is still low after turning it up to the maximum level, adjust the volume on your PC sound card or software program.

Source device issue

Issues	Solutions
A beeping sound is heard when my PC is booting.	If a beeping sound is heard when your PC is booting, have your PC serviced.



The LED lights on the frame of the product may be seen depending on the user's viewing angle. The light is harmless to people and has no bearing on product features and performance. The product is safe to use.

9.2 Q & A

Question	Answer
How can I change the frequency?	<p>Set the frequency on your graphics card.</p> <ul style="list-style-type: none"> • Windows XP: Go to Control Panel → Appearance and Themes → Display → Settings → Advanced → Monitor, and adjust Refresh rate under Monitor settings. • Windows ME/2000: Go to Control Panel → Display → Settings → Advanced → Monitor, and adjust Refresh rate under Monitor settings. • Windows Vista: Go to Control Panel → Appearance and Personalization → Personalization → Display Settings → Advanced Settings → Monitor, and adjust Refresh rate under Monitor settings. • Windows 7: Go to Control Panel → Appearance and Personalization → Display → Screen Resolution → Advanced settings → Monitor, and adjust Refresh rate under Monitor settings. • Windows 8: Go to Settings → Control Panel → Appearance and Personalization → Display → Screen Resolution → Advanced settings → Monitor, and adjust Refresh rate under Monitor settings. • Windows 10: Go to Settings → System → Display → Advanced display settings → Display adapter properties → Monitor, and adjust Screen refresh rate under Monitor settings.

Question	Answer
<p>How can I change the resolution?</p>	<ul style="list-style-type: none"> • Windows XP: Go to Control Panel → Appearance and Themes → Display → Settings, and adjust the resolution. • Windows ME/2000: Go to Control Panel → Display → Settings, and adjust the resolution. • Windows Vista: Go to Control Panel → Appearance and Personalization → Personalize → Display Settings, and adjust the resolution. • Windows 7: Go to Control Panel → Appearance and Personalization → Display → Adjust Resolution, and adjust the resolution. • Windows 8: Go to Settings → Control Panel → Appearance and Personalization → Display → Adjust Resolution, and adjust the resolution. • Windows 10: Go to Settings → System → Display → Advanced display settings, and adjust the resolution.
<p>How do I set power-saving mode?</p>	<ul style="list-style-type: none"> • Windows XP: Set power-saving mode in Control Panel → Appearance and Themes → Display → Screen Saver Settings → Power options or BIOS SETUP on the PC. • Windows ME/2000: Set power-saving mode in Control Panel → Display → Screen Saver Settings → Power options or BIOS SETUP on the PC. • Windows Vista: Set power-saving mode in Control Panel → Appearance and Personalization → Personalize → Screen Saver Settings → Power options or BIOS SETUP on the PC. • Windows 7: Set power-saving mode in Control Panel → Appearance and Personalization → Personalize → Screen Saver Settings → Power options or BIOS SETUP on the PC. • Windows 8: Set power-saving mode in Settings → Control Panel → Appearance and Personalization → Personalize → Screen Saver Settings → Power options or BIOS SETUP on the PC. • Windows 10: Set power-saving mode in Settings → Personalization → Lock screen → Screen timeout settings → Power & sleep or BIOS SETUP on the PC.



Refer to the user manual for your PC or graphics card for further instructions on adjustment.

10.1 General (S19E200NY / S19E200NW)

Model Name		S19E200NY	S19E200NW
Panel	Size	19 CLASS (18.5 inches / 47.0 cm)	19 CLASS (19.0 inches / 48.1 cm)
	Display area	409.8 mm (H) x 230.4 mm (V) 16.1 Inches (H) x 9.1 Inches (V)	408.24 mm (H) x 255.15 mm (V) 16.1 Inches (H) x 10.0 Inches (V)
	Pixel Pitch	0.300 mm (H) x 0.300 mm (V) 0.011811 Inches (H) x 0.011811 Inches (V)	0.2835 mm (H) x 0.2835 mm (V) 0.011161 Inches (H) x 0.011161 Inches (V)
Power Supply		This product uses 100 to 240 V. Refer to the label at the back of the product as the standard voltage can vary in different countries.	
Dimensions (W x H x D) / Weight	Without Stand	441.4 x 266.6 x 77.7 mm 17.4 x 10.5 x 3.1 Inches	439.4 x 289.9 x 76.9 mm 17.3 x 11.4 x 3.0 Inches
	With Stand	441.4 x 349.3 x 170.0 mm / 2.73 kg 17.4 x 13.8 x 6.7 Inches / 6.0 lbs	439.4 x 373.6 x 170.0 mm / 3.01 kg 17.3 x 14.7 x 6.7 Inches / 6.6 lbs
VESA Mounting Interface		100.0 mm x 100.0 mm 3.9 Inches x 3.9 Inches (For use with Specialty(Arm) Mounting hardware.)	
Environmental considerations	Operating	Temperature : 50 °F – 104 °F (10 °C – 40 °C) Humidity : 10% – 80%, non-condensing	
	Storage	Temperature : -4 °F – 113 °F (-20 °C – 45 °C) Humidity : 5% – 95%, non-condensing	



Plug-and-Play

This monitor can be installed and used with any Plug-and-Play compatible systems. Two-way data exchange between the monitor and PC system optimizes the monitor settings. Monitor installation takes place automatically. However, you can customize the installation settings if desired.



Panel Dots (Pixels)

Due to the nature of the manufacturing of this product, approximately 1 pixel per million (1ppm) may be brighter or darker on the LCD panel. This does not affect product performance.



The above specifications are subject to change without notice to improve quality.



This device is a Class B digital apparatus.

(USA only)

Dispose unwanted electronics through an approved recycler.

To find the nearest recycling location, go to our website:

www.samsung.com/recyclingdirect or call, (877) 278 - 0799

10.2 General (S19E200BW / S19E200BR)

Model Name		S19E200BW	S19E200BR
Panel	Size	19 CLASS (19.0 inches / 48.1 cm)	19 CLASS (19.0 inches / 48.2 cm)
	Display area	408.24 mm (H) x 255.15 mm (V) 16.1 Inches (H) x 10.0 Inches (V)	376.32 mm (H) x 301.06 mm (V) 14.8 Inches (H) x 11.9 Inches (V)
	Pixel Pitch	0.2835 mm (H) x 0.2835 mm (V) 0.011161 Inches (H) x 0.011161 Inches (V)	0.294 mm (H) x 0.294 mm (V) 0.011575 Inches (H) x 0.011575 Inches (V)
Power Supply		This product uses 100 to 240 V. Refer to the label at the back of the product as the standard voltage can vary in different countries.	
Dimensions (W x H x D) / Weight	Without Stand	439.4 x 289.9 x 76.9 mm 17.3 x 11.4 x 3.0 Inches	407.0 x 336.0 x 76.8 mm 16.0 x 13.2 x 3.0 Inches
	With Stand	439.4 x 373.6 x 170.0 mm / 3.01 kg 17.3 x 14.7 x 6.7 Inches / 6.6 lbs	407.0 x 419.6 x 170.0 mm / 3.21 kg 16.0 x 16.5 x 6.7 Inches / 7.1 lbs
VESA Mounting Interface		100.0 mm x 100.0 mm 3.9 Inches x 3.9 Inches (For use with Specialty(Arm) Mounting hardware.)	
Environmental considerations	Operating	Temperature : 50 °F – 104 °F (10 °C – 40 °C) Humidity : 10% – 80%, non-condensing	
	Storage	Temperature : -4 °F – 113 °F (-20 °C – 45 °C) Humidity : 5% – 95%, non-condensing	



Plug-and-Play

This monitor can be installed and used with any Plug-and-Play compatible systems. Two-way data exchange between the monitor and PC system optimizes the monitor settings. Monitor installation takes place automatically. However, you can customize the installation settings if desired.



Panel Dots (Pixels)

Due to the nature of the manufacturing of this product, approximately 1 pixel per million (1ppm) may be brighter or darker on the LCD panel. This does not affect product performance.



The above specifications are subject to change without notice to improve quality.



This device is a Class B digital apparatus.

(USA only)

Dispose unwanted electronics through an approved recycler.

To find the nearest recycling location, go to our website:

www.samsung.com/recyclingdirect or call, (877) 278 - 0799

10.3 General (S22E200NY)

Model Name		S22E200NY
Panel	Size	22 CLASS (21.5 inches / 54.6 cm)
	Display area	476.64 mm (H) x 268.11 mm (V) 18.8 Inches (H) x 10.6 Inches (V)
	Pixel Pitch	0.24825 mm (H) x 0.24825 mm (V) 0.009774 Inches (H) x 0.009774 Inches (V)
Power Supply		This product uses 100 to 240 V. Refer to the label at the back of the product as the standard voltage can vary in different countries.
Dimensions (W x H x D) / Weight	Without Stand	504.3 x 301.9 x 77.5 mm 19.9 x 11.9 x 3.1 Inches
	With Stand	504.3 x 385.4 x 170.0 mm / 3.37 kg 19.9 x 15.2 x 6.7 Inches / 7.4 lbs
VESA Mounting Interface		100.0 mm x 100.0 mm 3.9 Inches x 3.9 Inches (For use with Specialty(Arm) Mounting hardware.)
Environmental considerations	Operating	Temperature : 50 °F – 104 °F (10 °C – 40 °C) Humidity : 10% – 80%, non-condensing
	Storage	Temperature : -4 °F – 113 °F (-20 °C – 45 °C) Humidity : 5% – 95%, non-condensing



Plug-and-Play

This monitor can be installed and used with any Plug-and-Play compatible systems. Two-way data exchange between the monitor and PC system optimizes the monitor settings. Monitor installation takes place automatically. However, you can customize the installation settings if desired.



Panel Dots (Pixels)

Due to the nature of the manufacturing of this product, approximately 1 pixel per million (1ppm) may be brighter or darker on the LCD panel. This does not affect product performance.



The above specifications are subject to change without notice to improve quality.



This device is a Class B digital apparatus.

(USA only)

Dispose unwanted electronics through an approved recycler.

To find the nearest recycling location, go to our website:

www.samsung.com/recyclingdirect or call, (877) 278 - 0799

10.4 General (S22E200B / S22E200N / S22E200BW)

Model Name		S22E200B / S22E200N	S22E200BW
Panel	Size	22 CLASS (21.5 inches / 54.6 cm)	22 CLASS (22.0 inches / 55.8 cm)
	Display area	476.64 mm (H) x 268.11 mm (V) 18.8 Inches (H) x 10.6 Inches (V)	473.76 mm (H) x 296.1 mm (V) 18.7 Inches (H) x 11.7 Inches (V)
	Pixel Pitch	0.24825 mm (H) x 0.24825 mm (V) 0.009774 Inches (H) x 0.009774 Inches (V)	0.282 mm (H) x 0.282 mm (V) 0.011102 Inches (H) x 0.011102 Inches (V)
Power Supply		This product uses 100 to 240 V. Refer to the label at the back of the product as the standard voltage can vary in different countries.	
Dimensions (W x H x D) / Weight	Without Stand	504.3 x 301.9 x 77.5 mm 19.9 x 11.9 x 3.1 Inches	502.4 x 329.8 x 77.6 mm 19.8 x 13.0 x 3.1 Inches
	With Stand	504.3 x 385.4 x 170.0 mm / 3.52 kg 19.9 x 15.2 x 6.7 Inches / 7.8 lbs	502.4 x 414.0 x 170.0 mm / 3.70 kg 19.8 x 16.3 x 6.7 Inches / 8.2 lbs
VESA Mounting Interface		100.0 mm x 100.0 mm 3.9 Inches x 3.9 Inches (For use with Specialty(Arm) Mounting hardware.)	
Environmental considerations	Operating	Temperature : 50 °F – 104 °F (10 °C – 40 °C) Humidity : 10% – 80%, non-condensing	
	Storage	Temperature : -4 °F – 113 °F (-20 °C – 45 °C) Humidity : 5% – 95%, non-condensing	



Plug-and-Play

This monitor can be installed and used with any Plug-and-Play compatible systems. Two-way data exchange between the monitor and PC system optimizes the monitor settings. Monitor installation takes place automatically. However, you can customize the installation settings if desired.



Panel Dots (Pixels)

Due to the nature of the manufacturing of this product, approximately 1 pixel per million (1ppm) may be brighter or darker on the LCD panel. This does not affect product performance.



The above specifications are subject to change without notice to improve quality.



This device is a Class B digital apparatus.

(USA only)

Dispose unwanted electronics through an approved recycler.

To find the nearest recycling location, go to our website:

www.samsung.com/recyclingdirect or call, (877) 278 - 0799

10.5 General (S23E200B / S24E200BL)

Model Name		S23E200B	S24E200BL
Panel	Size	23 CLASS (23.0 inches / 58.4 cm)	24 CLASS (23.6 inches / 59.8 cm)
	Display area	509.76 mm (H) x 286.74 mm (V) 20.1 Inches (H) x 11.3 Inches (V)	521.28 mm (H) x 293.22 mm (V) 20.5 Inches (H) x 11.5 Inches (V)
	Pixel Pitch	0.2655 mm (H) x 0.2655 mm (V) 0.010453 Inches (H) x 0.010453 Inches (V)	0.2715 mm (H) x 0.2715 mm (V) 0.010689 Inches (H) x 0.010689 Inches (V)
Power Supply		This product uses 100 to 240 V. Refer to the label at the back of the product as the standard voltage can vary in different countries.	
Dimensions (W x H x D) / Weight	Without Stand	542.9 x 321.4 x 77.2 mm 21.4 x 12.7 x 3.0 Inches	554.6 x 330.5 x 78.1 mm 21.8 x 13.0 x 3.1 Inches
	With Stand	542.9 x 404.9 x 170.0 mm / 3.67 kg 21.4 x 15.9 x 6.7 Inches / 8.1 lbs	554.6 x 412.7 x 185.0 mm / 4.06 kg 21.8 x 16.2 x 7.3 Inches / 9.0 lbs
VESA Mounting Interface		100.0 mm x 100.0 mm 3.9 Inches x 3.9 Inches (For use with Specialty(Arm) Mounting hardware.)	
Environmental considerations	Operating	Temperature : 50 °F – 104 °F (10 °C – 40 °C) Humidity : 10% – 80%, non-condensing	
	Storage	Temperature : -4 °F – 113 °F (-20 °C – 45 °C) Humidity : 5% – 95%, non-condensing	



Plug-and-Play

This monitor can be installed and used with any Plug-and-Play compatible systems. Two-way data exchange between the monitor and PC system optimizes the monitor settings. Monitor installation takes place automatically. However, you can customize the installation settings if desired.



Panel Dots (Pixels)

Due to the nature of the manufacturing of this product, approximately 1 pixel per million (1ppm) may be brighter or darker on the LCD panel. This does not affect product performance.



The above specifications are subject to change without notice to improve quality.



This device is a Class B digital apparatus.

(USA only)

Dispose unwanted electronics through an approved recycler.

To find the nearest recycling location, go to our website:

www.samsung.com/recyclingdirect or call, (877) 278 - 0799

10.6 General (S19E450BW / S19E450MW / S19E450BR / S19E450MR)

Model Name		S19E450BW / S19E450MW	S19E450BR / S19E450MR
Panel	Size	19 CLASS (19.0 inches / 48.1 cm)	19 CLASS (19.0 inches / 48.2 cm)
	Display area	408.24 mm (H) x 255.15 mm (V) 16.1 Inches (H) x 10.0 Inches (V)	376.32 mm (H) x 301.06 mm (V) 14.8 Inches (H) x 11.9 Inches (V)
	Pixel Pitch	0.2835 mm (H) x 0.2835 mm (V) 0.011161 Inches (H) x 0.011161 Inches (V)	0.294 mm (H) x 0.294 mm (V) 0.011575 Inches (H) x 0.011575 Inches (V)
Power Supply		This product uses 100 to 240 V. Refer to the label at the back of the product as the standard voltage can vary in different countries.	
Dimensions (W x H x D) / Weight	Without Stand	439.4 x 289.9 x 55.7 mm / 2.71 kg 17.3 x 11.4 x 2.2 Inches / 6.0 lbs	407.0 x 336.0 x 54.8 mm / 2.91 kg 16.0 x 13.2 x 2.2 Inches / 6.4 lbs
	With Stand	MIN: 439.4 x 323.3 x 210.0 mm / 4.20 kg 17.3 x 12.7 x 8.3 Inches / 9.3 lbs MAX: 439.4 x 423.3 x 210.0 mm / 4.20 kg 17.3 x 16.7 x 8.3 Inches / 9.3 lbs	MIN: 407.0 x 368.9 x 210.0 mm / 4.40 kg 16.0 x 14.5 x 8.3 Inches / 9.7 lbs MAX: 407.0 x 468.9 x 210.0 mm / 4.40 kg 16.0 x 18.5 x 8.3 Inches / 9.7 lbs
VESA Mounting Interface		100.0 mm x 100.0 mm 3.9 Inches x 3.9 Inches (For use with Specialty(Arm) Mounting hardware.)	
Environmental considerations	Operating	Temperature : 50 °F – 104 °F (10 °C – 40 °C) Humidity : 10% – 80%, non-condensing	
	Storage	Temperature : -4 °F – 113 °F (-20 °C – 45 °C) Humidity : 5% – 95%, non-condensing	



Plug-and-Play

This monitor can be installed and used with any Plug-and-Play compatible systems. Two-way data exchange between the monitor and PC system optimizes the monitor settings. Monitor installation takes place automatically. However, you can customize the installation settings if desired.



Panel Dots (Pixels)

Due to the nature of the manufacturing of this product, approximately 1 pixel per million (1ppm) may be brighter or darker on the LCD panel. This does not affect product performance.



The above specifications are subject to change without notice to improve quality.



This device is a Class B digital apparatus.

(USA only)

Dispose unwanted electronics through an approved recycler.

To find the nearest recycling location, go to our website:

www.samsung.com/recyclingdirect or call, (877) 278 - 0799

10.7 General (S22E450B / S22E450M / S22E450D)

Model Name		S22E450B / S22E450M	S22E450D
Panel	Size	22 CLASS (21.5 inches / 54.6 cm)	
	Display area	476.64 mm (H) x 268.11 mm (V) 18.8 Inches (H) x 10.6 Inches (V)	
	Pixel Pitch	0.24825 mm (H) x 0.24825 mm (V) 0.009774 Inches (H) x 0.009774 Inches (V)	
Power Supply		This product uses 100 to 240 V. Refer to the label at the back of the product as the standard voltage can vary in different countries.	
Dimensions (W x H x D) / Weight	Without Stand	504.3 x 301.9 x 55.4 mm / 3.26 kg 19.9 x 11.9 x 2.2 Inches / 7.2 lbs	
	With Stand	MIN: 504.3 x 325.3 x 210.0 mm / 4.76 kg 19.9 x 12.8 x 8.3 Inches / 10.5 lbs MAX: 504.3 x 425.3 x 210.0 mm / 4.76 kg 19.9 x 16.7 x 8.3 Inches / 10.5 lbs	Without USB: MIN: 504.3 x 325.3 x 210.0 mm / 4.76 kg 19.9 x 12.8 x 8.3 Inches / 10.5 lbs MAX: 504.3 x 425.3 x 210.0 mm / 4.76 kg 19.9 x 16.7 x 8.3 Inches / 10.5 lbs With USB: MIN: 504.3 x 359.4 x 210.0 mm / 4.86 kg 19.9 x 14.1 x 8.3 Inches / 10.7 lbs MAX: 504.3 x 489.4 x 210.0 mm / 4.86 kg 19.9 x 19.3 x 8.3 Inches / 10.7 lbs
VESA Mounting Interface		100.0 mm x 100.0 mm 3.9 Inches x 3.9 Inches (For use with Specialty(Arm) Mounting hardware.)	
Environmental considerations	Operating	Temperature : 50 °F – 104 °F (10 °C – 40 °C) Humidity : 10% – 80%, non-condensing	
	Storage	Temperature : -4 °F – 113 °F (-20 °C – 45 °C) Humidity : 5% – 95%, non-condensing	



Plug-and-Play

This monitor can be installed and used with any Plug-and-Play compatible systems. Two-way data exchange between the monitor and PC system optimizes the monitor settings. Monitor installation takes place automatically. However, you can customize the installation settings if desired.



Panel Dots (Pixels)

Due to the nature of the manufacturing of this product, approximately 1 pixel per million (1ppm) may be brighter or darker on the LCD panel. This does not affect product performance.



The above specifications are subject to change without notice to improve quality.



This device is a Class B digital apparatus.

(USA only)

Dispose unwanted electronics through an approved recycler.

To find the nearest recycling location, go to our website:

www.samsung.com/recyclingdirect or call, (877) 278 - 0799

10.8 General (S22E450BW / S22E450MW / S22E450DW)

Model Name		S22E450BW / S22E450MW	S22E450DW
Panel	Size	22 CLASS (22.0 inches / 55.8 cm)	
	Display area	473.76 mm (H) x 296.1 mm (V) 18.7 Inches (H) x 11.7 Inches (V)	
	Pixel Pitch	0.282 mm (H) x 0.282 mm (V) 0.011102 Inches (H) x 0.011102 Inches (V)	
Power Supply		This product uses 100 to 240 V. Refer to the label at the back of the product as the standard voltage can vary in different countries.	
Dimensions (W x H x D) / Weight	Without Stand	502.4 x 329.8 x 55.7 mm / 3.42 kg 19.8 x 13.0 x 2.2 Inches / 7.5 lbs	
	With Stand	MIN: 502.4 x 353.4 x 210.0 mm / 4.91 kg 19.8 x 13.9 x 8.3 Inches / 10.8 lbs MAX: 502.4 x 453.4 x 210.0 mm / 4.91 kg 19.8 x 17.9 x 8.3 Inches / 10.8 lbs	Without USB: MIN: 502.4 x 353.4 x 210.0 mm / 4.91 kg 19.8 x 13.9 x 8.3 Inches / 10.8 lbs MAX: 502.4 x 453.4 x 210.0 mm / 4.91 kg 19.8 x 17.9 x 8.3 Inches / 10.8 lbs With USB: MIN: 502.4 x 387.5 x 210.0 mm / 5.03 kg 19.8 x 15.3 x 8.3 Inches / 11.1 lbs MAX: 502.4 x 517.5 x 210.0 mm / 5.03 kg 19.8 x 20.4 x 8.3 Inches / 11.1 lbs
VESA Mounting Interface		100.0 mm x 100.0 mm 3.9 Inches x 3.9 Inches (For use with Specialty(Arm) Mounting hardware.)	
Environmental considerations	Operating	Temperature : 50 °F – 104 °F (10 °C – 40 °C) Humidity : 10% – 80%, non-condensing	
	Storage	Temperature : -4 °F – 113 °F (-20 °C – 45 °C) Humidity : 5% – 95%, non-condensing	

**Plug-and-Play**

This monitor can be installed and used with any Plug-and-Play compatible systems. Two-way data exchange between the monitor and PC system optimizes the monitor settings. Monitor installation takes place automatically. However, you can customize the installation settings if desired.

**Panel Dots (Pixels)**

Due to the nature of the manufacturing of this product, approximately 1 pixel per million (1ppm) may be brighter or darker on the LCD panel. This does not affect product performance.



The above specifications are subject to change without notice to improve quality.



This device is a Class B digital apparatus.

(USA only)

Dispose unwanted electronics through an approved recycler.

To find the nearest recycling location, go to our website:

www.samsung.com/recyclingdirect or call, (877) 278 - 0799

10.9 General (S23E450B)

Model Name		S23E450B
Panel	Size	23 CLASS (23.0 inches / 58.4 cm)
	Display area	509.76 mm (H) x 286.74 mm (V) 20.1 Inches (H) x 11.3 Inches (V)
	Pixel Pitch	0.2655 mm (H) x 0.2655 mm (V) 0.010453 Inches (H) x 0.010453 Inches (V)
Power Supply		This product uses 100 to 240 V. Refer to the label at the back of the product as the standard voltage can vary in different countries.
Dimensions (W x H x D) / Weight	Without Stand	542.9 x 321.4 x 55.3 mm / 3.44 kg 21.4 x 12.7 x 2.2 Inches / 7.6 lbs
	With Stand	MIN: 542.9 x 344.7 x 224.0 mm / 5.13 kg 21.4 x 13.6 x 8.8 Inches / 11.3 lbs MAX: 542.9 x 474.7 x 224.0 mm / 5.13 kg 21.4 x 18.7 x 8.8 Inches / 11.3 lbs
VESA Mounting Interface		100.0 mm x 100.0 mm 3.9 Inches x 3.9 Inches (For use with Specialty(Arm) Mounting hardware.)
Environmental considerations	Operating	Temperature : 50 °F – 104 °F (10 °C – 40 °C) Humidity : 10% – 80%, non-condensing
	Storage	Temperature : -4 °F – 113 °F (-20 °C – 45 °C) Humidity : 5% – 95%, non-condensing



Plug-and-Play

This monitor can be installed and used with any Plug-and-Play compatible systems. Two-way data exchange between the monitor and PC system optimizes the monitor settings. Monitor installation takes place automatically. However, you can customize the installation settings if desired.



Panel Dots (Pixels)

Due to the nature of the manufacturing of this product, approximately 1 pixel per million (1ppm) may be brighter or darker on the LCD panel. This does not affect product performance.



The above specifications are subject to change without notice to improve quality.



This device is a Class B digital apparatus.

(USA only)

Dispose unwanted electronics through an approved recycler.

To find the nearest recycling location, go to our website:

www.samsung.com/recyclingdirect or call, (877) 278 - 0799



Specifications

10.10 General (S24E450BL / S24E450DL)

Model Name		S24E450BL	S24E450DL
Panel	Size	24 CLASS (23.6 inches / 59.8 cm)	
	Display area	521.28 mm (H) x 293.22 mm (V) 20.5 Inches (H) x 11.5 Inches (V)	
	Pixel Pitch	0.2715 mm (H) x 0.2715 mm (V) 0.010689 Inches (H) x 0.010689 Inches (V)	
Power Supply		This product uses 100 to 240 V. Refer to the label at the back of the product as the standard voltage can vary in different countries.	
Dimensions (W x H x D) / Weight	Without Stand	554.6 x 330.5 x 55.4 mm / 3.78 kg 21.8 x 13.0 x 2.2 Inches / 8.3 lbs	
	With Stand	MIN: 554.6 x 352.3 x 224.0 mm / 5.48 kg 21.8 x 13.9 x 8.8 Inches / 12.0 lbs MAX: 554.6 x 482.3 x 224.0 mm / 5.48 kg 21.8 x 19.0 x 8.8 Inches / 12.0 lbs	Without USB: MIN: 554.6 x 352.3 x 224.0 mm / 5.48 kg 21.8 x 13.9 x 8.8 Inches / 12.0 lbs MAX: 554.6 x 482.3 x 224.0 mm / 5.48 kg 21.8 x 19.0 x 8.8 Inches / 12.0 lbs With USB: MIN: 554.6 x 357.3 x 224.0 mm / 5.48 kg 21.8 x 14.1 x 8.8 Inches / 12.0 lbs MAX: 554.6 x 487.3 x 224.0 mm / 5.48 kg 21.8 x 19.2 x 8.8 Inches / 12.0 lbs
VESA Mounting Interface		100.0 mm x 100.0 mm 3.9 Inches x 3.9 Inches (For use with Specialty(Arm) Mounting hardware.)	
Environmental considerations	Operating	Temperature : 50 °F – 104 °F (10 °C – 40 °C) Humidity : 10% – 80%, non-condensing	
	Storage	Temperature : -4 °F – 113 °F (-20 °C – 45 °C) Humidity : 5% – 95%, non-condensing	

**Plug-and-Play**

This monitor can be installed and used with any Plug-and-Play compatible systems. Two-way data exchange between the monitor and PC system optimizes the monitor settings. Monitor installation takes place automatically. However, you can customize the installation settings if desired.

**Panel Dots (Pixels)**

Due to the nature of the manufacturing of this product, approximately 1 pixel per million (1ppm) may be brighter or darker on the LCD panel. This does not affect product performance.



The above specifications are subject to change without notice to improve quality.



This device is a Class B digital apparatus.

(USA only)

Dispose unwanted electronics through an approved recycler.

To find the nearest recycling location, go to our website:

www.samsung.com/recyclingdirect or call, (877) 278 - 0799



Specifications

10.11 General (S24E450B / S24E450M / S24E450D)

Model Name		S24E450B / S24E450M	S24E450D
Panel	Size	24 CLASS (24.0 inches / 60.9 cm)	
	Display area	531.36 mm (H) x 298.89 mm (V) 20.9 Inches (H) x 11.8 Inches (V)	
	Pixel Pitch	0.27675 mm (H) x 0.27675 mm (V) 0.010896 Inches (H) x 0.010896 Inches (V)	
Power Supply		This product uses 100 to 240 V. Refer to the label at the back of the product as the standard voltage can vary in different countries.	
Dimensions (W x H x D) / Weight	Without Stand	565.4 x 333.2 x 56.6 mm / 3.40 kg 22.3 x 13.1 x 2.2 Inches / 7.5 lbs	
	With Stand	MIN: 565.4 x 356.8 x 224.0 mm / 5.10 kg 22.3 x 14.0 x 8.8 Inches / 11.2 lbs MAX: 565.4 x 486.8 x 224.0 mm / 5.10 kg 22.3 x 19.2 x 8.8 Inches / 11.2 lbs	Without USB: MIN: 565.4 x 356.8 x 224.0 mm / 5.10 kg 22.3 x 14.0 x 8.8 Inches / 11.2 lbs MAX: 565.4 x 486.8 x 224.0 mm / 5.10 kg 22.3 x 19.2 x 8.8 Inches / 11.2 lbs With USB: MIN: 565.4 x 361.8 x 224.0 mm / 5.10 kg 22.3 x 14.2 x 8.8 Inches / 11.2 lbs MAX: 565.4 x 491.8 x 224.0 mm / 5.10 kg 22.3 x 19.4 x 8.8 Inches / 11.2 lbs
VESA Mounting Interface		100.0 mm x 100.0 mm 3.9 Inches x 3.9 Inches (For use with Specialty(Arm) Mounting hardware.)	
Environmental considerations	Operating	Temperature : 50 °F – 104 °F (10 °C – 40 °C) Humidity : 10% – 80%, non-condensing	
	Storage	Temperature : -4 °F – 113 °F (-20 °C – 45 °C) Humidity : 5% – 95%, non-condensing	

**Plug-and-Play**

This monitor can be installed and used with any Plug-and-Play compatible systems. Two-way data exchange between the monitor and PC system optimizes the monitor settings. Monitor installation takes place automatically. However, you can customize the installation settings if desired.

**Panel Dots (Pixels)**

Due to the nature of the manufacturing of this product, approximately 1 pixel per million (1ppm) may be brighter or darker on the LCD panel. This does not affect product performance.



The above specifications are subject to change without notice to improve quality.



This device is a Class B digital apparatus.

(USA only)

Dispose unwanted electronics through an approved recycler.

To find the nearest recycling location, go to our website:

www.samsung.com/recyclingdirect or call, (877) 278 - 0799

10.12 General (S24E650BW)

Model Name		S24E650BW
Panel	Size	24 CLASS (24.0 inches / 61.1 cm)
	Display area	518.4 mm (H) x 324.0 mm (V) 20.4 Inches (H) x 12.8 Inches (V)
	Pixel Pitch	0.270 mm (H) x 0.270 mm (V) 0.01063 Inches (H) x 0.01063 Inches (V)
Power Supply		This product uses 100 to 240 V. Refer to the label at the back of the product as the standard voltage can vary in different countries.
Dimensions (W x H x D) / Weight	Without Stand	554.8 x 359.4 x 55.1 mm / 4.11 kg 21.8 x 14.1 x 2.2 Inches / 9.1 lbs
	With Stand	MIN: 554.8 x 382.3 x 224.0 mm / 5.80 kg 21.8 x 15.1 x 8.8 Inches / 12.8 lbs MAX: 554.8 x 512.3 x 224.0 mm / 5.80 kg 21.8 x 20.2 x 8.8 Inches / 12.8 lbs
VESA Mounting Interface		100.0 mm x 100.0 mm 3.9 Inches x 3.9 Inches (For use with Specialty(Arm) Mounting hardware.)
Environmental considerations	Operating	Temperature : 50 °F – 104 °F (10 °C – 40 °C) Humidity : 10% – 80%, non-condensing
	Storage	Temperature : -4 °F – 113 °F (-20 °C – 45 °C) Humidity : 5% – 95%, non-condensing

**Plug-and-Play**

This monitor can be installed and used with any Plug-and-Play compatible systems. Two-way data exchange between the monitor and PC system optimizes the monitor settings. Monitor installation takes place automatically. However, you can customize the installation settings if desired.

**Panel Dots (Pixels)**

Due to the nature of the manufacturing of this product, approximately 1 pixel per million (1ppm) may be brighter or darker on the LCD panel. This does not affect product performance.



The above specifications are subject to change without notice to improve quality.



This device is a Class B digital apparatus.



Specifications

(USA only)

Dispose unwanted electronics through an approved recycler.

To find the nearest recycling location, go to our website:

www.samsung.com/recyclingdirect or call, (877) 278 - 0799



Specifications

10.13 General (S27E450B / S27E450D)

Model Name		S27E450B	S27E450D
Panel	Size	27 CLASS (27.0 inches / 68.5 cm)	
	Display area	597.6 mm (H) x 336.15 mm (V) 23.5 Inches (H) x 13.2 Inches (V)	
	Pixel Pitch	0.3114 mm (H) x 0.3114 mm (V) 0.01226 Inches (H) x 0.01226 Inches (V)	
Power Supply		This product uses 100 to 240 V. Refer to the label at the back of the product as the standard voltage can vary in different countries.	
Dimensions (W x H x D) / Weight	Without Stand	639.0 x 378.1 x 57.6 mm / 4.60 kg 25.2 x 14.9 x 2.3 Inches / 10.1 lbs	
	With Stand	MIN: 639.0 x 397.8 x 224.0 mm / 6.29 kg 25.2 x 15.7 x 8.8 Inches / 13.9 lbs MAX: 639.0 x 527.8 x 224.0 mm / 6.29 kg 25.2 x 20.8 x 8.8 Inches / 13.9 lbs	Without USB: MIN: 639.0 x 397.8 x 224.0 mm / 6.29 kg 25.2 x 15.7 x 8.8 Inches / 13.9 lbs MAX: 639.0 x 527.8 x 224.0 mm / 6.29 kg 25.2 x 20.8 x 8.8 Inches / 13.9 lbs With USB: MIN: 639.0 x 402.8 x 224.0 mm / 6.29 kg 25.2 x 15.9 x 8.8 Inches / 13.9 lbs MAX: 639.0 x 532.8 x 224.0 mm / 6.29 kg 25.2 x 21.0 x 8.8 Inches / 13.9 lbs
VESA Mounting Interface		100.0 mm x 100.0 mm 3.9 Inches x 3.9 Inches (For use with Specialty(Arm) Mounting hardware.)	
Environmental considerations	Operating	Temperature : 50 °F – 104 °F (10 °C – 40 °C) Humidity : 10% – 80%, non-condensing	
	Storage	Temperature : -4 °F – 113 °F (-20 °C – 45 °C) Humidity : 5% – 95%, non-condensing	

**Plug-and-Play**

This monitor can be installed and used with any Plug-and-Play compatible systems. Two-way data exchange between the monitor and PC system optimizes the monitor settings. Monitor installation takes place automatically. However, you can customize the installation settings if desired.

**Panel Dots (Pixels)**

Due to the nature of the manufacturing of this product, approximately 1 pixel per million (1ppm) may be brighter or darker on the LCD panel. This does not affect product performance.



The above specifications are subject to change without notice to improve quality.



This device is a Class B digital apparatus.

(USA only)

Dispose unwanted electronics through an approved recycler.

To find the nearest recycling location, go to our website:

www.samsung.com/recyclingdirect or call, (877) 278 - 0799

10.14 PowerSaver

The power-saving function of this product reduces power consumption by switching off the screen and making the Power LED blink if the product is not used for a specified period of time. The power is not turned off in power-saving mode. To switch the screen back on, press any key on the keyboard or move the mouse. Power-saving mode functions only when the product is connected to a PC that has a power-saving function.

PowerSaver	Normal operation mode	Energy Star Power Consumption	Power saving mode	Power off (Power button)
Power Indicator	On	On	Blinking	Off
Power Consumption (S19E200NY)	Typical 19 W	Typical 13 W	Less than 0.1 W	Less than 0.1 W
Power Consumption (S19E200BR)		Typical 16 W		
Power Consumption (S19E200NW)		Typical 15 W		
Power Consumption (S19E200BW)				
Power Consumption (S22E200NY)	Typical 24 W	Typical 21 W	Less than 0.1 W	Less than 0.1 W
Power Consumption (S22E200N)				
Power Consumption (S22E200B)				
Power Consumption (S22E200BW)				

PowerSaver	Normal operation mode	Energy Star Power Consumption	Power saving mode	Power off (Power button)
Power Consumption (S23E200B)	Typical 25 W	Typical 22 W	Less than 0.1 W	Less than 0.1 W
Power Consumption (S24E200BL)				
Power Consumption (S19E450BW)	Typical 19 W	Typical 15 W	Typical 0.3 W	Less than 0.005 W (0 W mode)
Power Consumption (S19E450MW)		Typical 16 W		
Power Consumption (S19E450BR)				
Power Consumption (S19E450MR)				
Power Consumption (S22E450B)	Typical 24 W	Typical 21 W		

PowerSaver	Normal operation mode	Energy Star Power Consumption	Power saving mode	Power off (Power button)
Power Consumption (S22E450M)	Typical 24 W	Typical 21 W	Typical 0.3 W	Less than 0.005 W (0 W mode)
Power Consumption (S22E450D)				
Power Consumption (S22E450BW)		Typical 19 W		
Power Consumption (S22E450MW)				
Power Consumption (S22E450DW)				
Power Consumption (S23E450B)	Typical 25 W	Typical 22 W		
Power Consumption (S24E450BL)				
Power Consumption (S24E450DL)				

PowerSaver	Normal operation mode	Energy Star Power Consumption	Power saving mode	Power off (Power button)
Power Consumption (S24E450B)	Typical 25 W	Typical 23 W	Typical 0.3 W	Less than 0.005 W (0 W mode)
Power Consumption (S24E450M)				
Power Consumption (S24E450D)				
Power Consumption (S24E650BW)	Typical 31 W	Typical 25 W		
Power Consumption (S27E450B)	Typical 35 W	Typical 29 W		
Power Consumption (S27E450D)				



- The displayed power consumption level can vary in different operating conditions or when settings are changed. (S**E200** Model Power saving mode / Power off (Power button) : Less than 0.1 watts (Analog Input Condition), Max 0.25 watts) (S**E450** & S**E650** Model Power off (Power button) : Less than 0.005 watts (0 W mode). The 0 W mode indicates that the product is not receiving external commands. The power consumption is higher when the product receives an external command, such as a signal from the Magic Rotation program.)
- ENERGY STAR® is a US registered mark of the United States Environmental Protection Agency. Energy Star power is measured with the test method in the current Energy Star® Standard.
- To reduce the power consumption to 0, disconnect the power cord. Be sure to disconnect the power cable when you will not be using the product for an extended period of time. To reduce the power consumption to 0 W when the power switch is not available, disconnect the power cable.

10.15 Standard Signal Mode Table



- This product can be set to only one resolution for each screen size to obtain the optimum picture quality due to the nature of the panel. Therefore, a resolution other than the specified resolution may degrade the picture quality. To avoid this, it is recommended that you select the optimum resolution specified for the screen size of your product.
- Check the frequency when you exchange a CDT monitor (connected to a PC) for an LCD monitor. If the LCD monitor does not support 85 Hz, change the vertical frequency to 60 Hz using the CDT monitor before you exchange it with the LCD monitor.

Model Name	Synchronization		Resolution	
	Horizontal Frequency	Vertical Frequency	Optimum Resolution	Maximum Resolution
S19E200NY	30 – 81 kHz	56 – 75 Hz	1366 x 768 @ 60 Hz	1366 x 768 @ 60 Hz
S19E200NW S19E200BW S19E450BW S19E450MW			1440 x 900 @ 60 Hz	1440 x 900 @ 75 Hz
S19E200BR S19E450BR S19E450MR			1280 x 1024 @ 60 Hz	1280 x 1024 @ 75 Hz
S22E200BW S22E450BW S22E450MW S22E450DW			1680 x 1050 @ 60 Hz	1680 x 1050 @ 60 Hz
S22E200NY S22E200N			1920 x 1080 @ 60 Hz	1920 x 1080 @ 60 Hz
S22E200B S23E200B S24E200BL S22E450B S22E450M S22E450D S23E450B S24E450BL S24E450DL				

Model Name	Synchronization		Resolution	
	Horizontal Frequency	Vertical Frequency	Optimum Resolution	Maximum Resolution
S24E650BW	30 – 81 kHz	56 – 60 Hz	1920 x 1200 @ 60 Hz	1920 x 1200 @ 60 Hz
S24E450B		56 – 75 Hz	1920 x 1080 @ 60 Hz	1920 x 1080 @ 60 Hz
S24E450M				
S24E450D				
S27E450B				
S27E450D				

If a signal that belongs to the following standard signal modes is transmitted from your PC, the screen will automatically be adjusted. If the signal transmitted from the PC does not belong to the standard signal modes, the screen may be blank even though the power LED turns on. In such a case, change the settings according to the following table by referring to the graphics card user manual.

S19E200NY

Resolution	Horizontal Frequency (kHz)	Vertical Frequency (Hz)	Pixel Clock (MHz)	Sync Polarity (H/V)
IBM, 720 x 400	31.469	70.087	28.322	-/+
MAC, 640 x 480	35.000	66.667	30.240	-/-
MAC, 832 x 624	49.726	74.551	57.284	-/-
VESA, 640 x 480	31.469	59.940	25.175	-/-
VESA, 640 x 480	37.861	72.809	31.500	-/-
VESA, 640 x 480	37.500	75.000	31.500	-/-
VESA, 800 x 600	35.156	56.250	36.000	+/+
VESA, 800 x 600	37.879	60.317	40.000	+/+
VESA, 800 x 600	48.077	72.188	50.000	+/+
VESA, 800 x 600	46.875	75.000	49.500	+/+
VESA, 1024 x 768	48.363	60.004	65.000	-/-
VESA, 1024 x 768	56.476	70.069	75.000	-/-
VESA, 1024 x 768	60.023	75.029	78.750	+/+
VESA, 1280 x 720	45.000	60.000	74.250	+/+
VESA, 1366 x 768	47.712	59.790	85.500	+/+

S19E200NW / S19E200BW / S19E450BW / S19E450MW

Resolution	Horizontal Frequency (kHz)	Vertical Frequency (Hz)	Pixel Clock (MHz)	Sync Polarity (H/V)
IBM, 720 x 400	31.469	70.087	28.322	-/+
MAC, 640 x 480	35.000	66.667	30.240	-/-
MAC, 832 x 624	49.726	74.551	57.284	-/-
MAC, 1152 x 870	68.681	75.062	100.000	-/-
VESA, 640 x 480	31.469	59.940	25.175	-/-
VESA, 640 x 480	37.861	72.809	31.500	-/-
VESA, 640 x 480	37.500	75.000	31.500	-/-
VESA, 800 x 600	35.156	56.250	36.000	+/+
VESA, 800 x 600	37.879	60.317	40.000	+/+
VESA, 800 x 600	48.077	72.188	50.000	+/+
VESA, 800 x 600	46.875	75.000	49.500	+/+
VESA, 1024 x 768	48.363	60.004	65.000	-/-
VESA, 1024 x 768	56.476	70.069	75.000	-/-
VESA, 1024 x 768	60.023	75.029	78.750	+/+
VESA, 1152 x 864	67.500	75.000	108.000	+/+
VESA, 1280 x 720	45.000	60.000	74.250	+/+
VESA, 1280 x 800	49.702	59.810	83.500	-/+
VESA, 1440 x 900	55.935	59.887	106.500	-/+
VESA, 1440 x 900	70.635	74.984	136.750	-/+

S19E200BR / S19E450BR / S19E450MR

Resolution	Horizontal Frequency (kHz)	Vertical Frequency (Hz)	Pixel Clock (MHz)	Sync Polarity (H/V)
IBM, 720 x 400	31.469	70.087	28.322	-/+
MAC, 640 x 480	35.000	66.667	30.240	-/-
MAC, 832 x 624	49.726	74.551	57.284	-/-
MAC, 1152 x 870	68.681	75.062	100.000	-/-
VESA, 640 x 480	31.469	59.940	25.175	-/-
VESA, 640 x 480	37.861	72.809	31.500	-/-
VESA, 640 x 480	37.500	75.000	31.500	-/-
VESA, 800 x 600	35.156	56.250	36.000	+/+
VESA, 800 x 600	37.879	60.317	40.000	+/+
VESA, 800 x 600	48.077	72.188	50.000	+/+
VESA, 800 x 600	46.875	75.000	49.500	+/+
VESA, 1024 x 768	48.363	60.004	65.000	-/-
VESA, 1024 x 768	56.476	70.069	75.000	-/-
VESA, 1024 x 768	60.023	75.029	78.750	+/+
VESA, 1152 x 864	67.500	75.000	108.000	+/+
VESA, 1280 x 720	45.000	60.000	74.250	+/+
VESA, 1280 x 800	49.702	59.810	83.500	-/+
VESA, 1280 x 960	60.000	60.000	108.000	+/+
VESA, 1280 x 1024	63.981	60.020	108.000	+/+
VESA, 1280 x 1024	79.976	75.025	135.000	+/+

S22E200NY / S22E200N / S22E200B / S23E200B / S24E200BL / S22E450B / S22E450M / S22E450D
 / S23E450B / S24E450BL / S24E450DL / S24E450B / S24E450M / S24E450D / S27E450B / S27E450D

Resolution	Horizontal Frequency (kHz)	Vertical Frequency (Hz)	Pixel Clock (MHz)	Sync Polarity (H/V)
IBM, 720 x 400	31.469	70.087	28.322	-/+
MAC, 640 x 480	35.000	66.667	30.240	-/-
MAC, 832 x 624	49.726	74.551	57.284	-/-
MAC, 1152 x 870	68.681	75.062	100.000	-/-
VESA, 640 x 480	31.469	59.940	25.175	-/-
VESA, 640 x 480	37.861	72.809	31.500	-/-
VESA, 640 x 480	37.500	75.000	31.500	-/-
VESA, 800 x 600	35.156	56.250	36.000	+/+
VESA, 800 x 600	37.879	60.317	40.000	+/+
VESA, 800 x 600	48.077	72.188	50.000	+/+
VESA, 800 x 600	46.875	75.000	49.500	+/+
VESA, 1024 x 768	48.363	60.004	65.000	-/-
VESA, 1024 x 768	56.476	70.069	75.000	-/-
VESA, 1024 x 768	60.023	75.029	78.750	+/+
VESA, 1152 x 864	67.500	75.000	108.000	+/+
VESA, 1280 x 720	45.000	60.000	74.250	+/+
VESA, 1280 x 800	49.702	59.810	83.500	-/+
VESA, 1280 x 1024	63.981	60.020	108.000	+/+
VESA, 1280 x 1024	79.976	75.025	135.000	+/+
VESA, 1440 x 900	55.935	59.887	106.500	-/+
VESA, 1600 x 900	60.000	60.000	108.000	+/+
VESA, 1680 x 1050	65.290	59.954	146.250	-/+
VESA, 1920 x 1080	67.500	60.000	148.500	+/+

S22E200BW / S22E450BW / S22E450MW / S22E450DW

Resolution	Horizontal Frequency (kHz)	Vertical Frequency (Hz)	Pixel Clock (MHz)	Sync Polarity (H/V)
IBM, 720 x 400	31.469	70.087	28.322	-/+
MAC, 640 x 480	35.000	66.667	30.240	-/-
MAC, 832 x 624	49.726	74.551	57.284	-/-
MAC, 1152 x 870	68.681	75.062	100.000	-/-
VESA, 640 x 480	31.469	59.940	25.175	-/-
VESA, 640 x 480	37.861	72.809	31.500	-/-
VESA, 640 x 480	37.500	75.000	31.500	-/-
VESA, 800 x 600	35.156	56.250	36.000	+/+
VESA, 800 x 600	37.879	60.317	40.000	+/+
VESA, 800 x 600	48.077	72.188	50.000	+/+
VESA, 800 x 600	46.875	75.000	49.500	+/+
VESA, 1024 x 768	48.363	60.004	65.000	-/-
VESA, 1024 x 768	56.476	70.069	75.000	-/-
VESA, 1024 x 768	60.023	75.029	78.750	+/+
VESA, 1152 x 864	67.500	75.000	108.000	+/+
VESA, 1280 x 720	45.000	60.000	74.250	+/+
VESA, 1280 x 800	49.702	59.810	83.500	-/+
VESA, 1280 x 1024	63.981	60.020	108.000	+/+
VESA, 1280 x 1024	79.976	75.025	135.000	+/+
VESA, 1440 x 900	55.935	59.887	106.500	-/+
VESA, 1600 x 900	60.000	60.000	108.000	+/+
VESA, 1680 x 1050	65.290	59.954	146.250	-/+

S24E650BW

Resolution	Horizontal Frequency (kHz)	Vertical Frequency (Hz)	Pixel Clock (MHz)	Sync Polarity (H/V)
VESA, 640 x 480	31.469	59.940	25.175	-/-
VESA, 800 x 600	35.156	56.250	36.000	+/+
VESA, 800 x 600	37.879	60.317	40.000	+/+
VESA, 1024 x 768	48.363	60.004	65.000	-/-
VESA, 1280 x 720	45.000	60.000	74.250	+/+
VESA, 1280 x 800	49.702	59.810	83.500	-/+
VESA, 1280 x 1024	63.981	60.020	108.000	+/+
VESA, 1440 x 900	55.935	59.887	106.500	-/+
VESA, 1600 x 900	60.000	60.000	108.000	+/+
VESA, 1680 x 1050	65.290	59.954	146.250	-/+
VESA, 1920 x 1080	67.500	60.000	148.500	+/+
VESA, 1920 x 1200	74.038	59.950	154.000	+/-



- Horizontal Frequency

The time required to scan a single line from the left to the right side of the screen is called a horizontal cycle. The reciprocal number of a horizontal cycle is called horizontal frequency. Horizontal frequency is measured in kHz.

- Vertical Frequency

Repeating the same picture dozens of times per second allows you to view natural pictures. The repeat frequency is called "vertical frequency" or "refresh rate" and is indicated in Hz.

Responsibility for the Pay Service (Cost to Customers)



When the service is requested, in spite of in warranty, we may charge you for a visit from a service technician in the following cases.

Not a product defect

Cleaning of the product, Adjustment, Explanation, Re-installation and etc.

- If a service technician gives instructions on how to use product or simply adjusts options without disassembling product.
- If a defect is caused by external environmental factors. (Internet, Antenna, Wired Signal, etc.)
- If a product is reinstalled or devices are connected additionally after installing the purchased product for the first time.
- If a product is reinstalled to move to a different spot or to move to a different house.
- If customer requests instructions on how to use because of another company's product.
- If customer requests instructions on how to use the network or another company's program.
- If customer requests software installation and setup for the product.
- If a service technician removes/cleans dusts or foreign materials inside of the product.
- If customer requests an installation additionally after purchasing a product through home-shopping or online.

A Product damage caused by customer's fault

Product damage caused by customer's mishandling or wrong repair

If a product damage is caused by;

- external impact or drop.
- use of supplies or separately sold product unspecified by Samsung.
- repair from a person besides an engineer of outsourcing service company or partner of Samsung Electronics Co., Ltd.
- remodeling or repairing the product by customer.
- using it with incorrect voltage or non-authorized electrical connections.
- not following the "cautions" in User Manual.

Others

- If product fails by natural disaster. (lightning, fire, earthquake, flood damage, etc)
- If consumable components are all used up. (Battery, Toner, Fluorescent lights, Head, Vibrator, Lamp, Filter, Ribbon, etc.)

Appendix



If customer requests a service in case the product has no defect, service fee may be charged. So please read User Manual first.

Correct Disposal

Correct Disposal of This Product (Waste Electrical & Electronic Equipment)



(Applicable in countries with separate collection systems)

This marking on the product, accessories or literature indicates that the product and its electronic accessories (e.g. charger, headset, USB cable) should not be disposed of with other household waste at the end of their working life. To prevent possible harm to the environment or human health from uncontrolled waste disposal, please separate these items from other types of waste and recycle them responsibly to promote the sustainable reuse of material resources.

Household users should contact either the retailer where they purchased this product, or their local government office, for details of where and how they can take these items for environmentally safe recycling.

Business users should contact their supplier and check the terms and conditions of the purchase contract. This product and its electronic accessories should not be mixed with other commercial wastes for disposal.

Extended warranty

You can buy an extended warranty within 90 days of purchasing the product.

The extended warranty will cover an additional period of 3 years, beyond the standard 3 year warranty.

Samsung guarantee that replacement parts will be available for 5 years after the end of production.

After 5 years, in the event that the Samsung's service center has run out of replacement parts and cannot repair the product, Samsung will replace your product at no additional charge. If the model you purchased is no longer available, Samsung replace it with the current equivalent model.

Terminology

OSD (On Screen Display)

On screen display (OSD) allows you to customize on-screen settings to optimize the picture quality as required. You can change the screen brightness, tint, size and many other settings using menus displayed on the screen.

Gamma

The Gamma menu adjusts the grey scale that represents middle tones on the screen. Adjusting the brightness brightens the whole screen, but adjusting Gamma only brightens the medium brightness.

Grey scale

Scale refers to levels of color intensity that show variations of color change from darker areas to brighter areas on the screen. Changes to the screen brightness are expressed with black and white variation, and grey scale refers to the medium area between black and white. Changing the grey scale through Gamma adjustment will change the medium brightness on the screen.

Scanning rate

Scanning rate, or refresh rate, refers to the frequency of screen refreshes. Screen data is transmitted as it refreshes to display an image, although the refreshing is invisible to the naked eye. The number of screen refreshes is called scanning rate and is measured in Hz. A scanning rate of 60Hz means that the screen refreshes 60 times per second. The screen scanning rate depends on the performance of the graphics cards in your PC and monitor.

Horizontal Frequency

Characters or images displayed on the monitor screen consist of numerous dots (pixels). Pixels are transmitted in horizontal lines, which are then arranged vertically to create an image. The horizontal frequency is measured in kHz and represents how many times horizontal lines per second are transmitted and displayed on the monitor screen. A horizontal frequency of 85 means that the horizontal lines that make up an image are transmitted 85000 times per second. The horizontal frequency is indicated in 85kHz.

Vertical Frequency

One image is made of numerous horizontal lines. The vertical frequency is measured in Hz and represents how many images can be created per second by those horizontal lines. A vertical frequency of 60 means that an image is transmitted 60 times per second. The vertical frequency is also called "refresh rate" and affects screen flicker.

Resolution

Resolution is the number of horizontal pixels and vertical pixels that form a screen. It represents the level of display detail.

A higher resolution displays a greater amount of information on the screen and is suitable for performing multiple tasks at the same time.

E.g. A resolution of 1920 x 1080 consists of 1920 horizontal pixels (horizontal resolution) and 1080 vertical lines (vertical resolution).

Plug & Play

The Plug & Play feature allows the automatic exchange of information between a monitor and PC to produce an optimum display environment.

The monitor uses VESA DDC (international standard) to execute Plug & Play.

Index

B

Before Connecting 45
Blue 74
Brightness 57

C

Cleaning 9
Coarse 70
Color Tone 75
Connecting and Using a PC 46
Contrast 58
Copyright 8
Correct Disposal 142
Correct posture to use the product 19

D

Display Time 79

E

Eye Saver Mode 60

F

Fine 71

G

Game Mode 61
Gamma 76
General 103
Green 73

I

Image Size 66
INFORMATION 93
Installation 35

K

Key Repeat Time 91

L

Language 77

M

MultiScreen 96

O

Off Timer 83
Off Timer Plus 85

P

Parts 22
PC/AV Mode 89
PowerSaver 128

Q

Q & A 101

R

Red 72
Requirements Before Contacting Samsung
Customer Service Center 98
Reset All 81
Response Time 68
Responsibility for the Pay Service (Cost to
Customers) 140

S

Safety Precautions 11
SAMSUNG MAGIC Angle 63
SAMSUNG MAGIC Bright 62
SAMSUNG MAGIC Upscale 65

Index

Sharpness 59
Smart Eco Saving 82
Source Detection 92
Standard Signal Mode Table 132

T

Terminology 143
Transparency 80