

USER MANUAL

ProLite

LCD Monitor

ENGLISH

ProLite XB2788QS
ProLite X2788QS

Thank you very much for choosing the iiyama LCD monitor.

We recommend that you take a few minutes to read carefully through this brief but comprehensive manual before installing and switching on the monitor. Please keep this manual in a safe place for your future reference.



Dear user, we congratulate you on the purchase of your iiyama LCD.

For details on warranty and locally used pixel policies that apply directly after installation of your product please check the iiyama website.

To report a fault, please contact your local support centre found at www.iiyama.com/service

Things to check before you call the iiyama information line

- | if the power cable is connected securely and turned on?
- | if the display has been turned on?
- | if the signal cable is connected securely and the correct input selected?
- | if the computer has been restarted with the display connected?
- | if the graphics card is correctly installed with the latest drivers possible?
- | if the correct native resolution has been selected via 'Display Properties'?
- | if the R/G/B signal configuration is correct?
- | if the displays On Screen Menu is shown?
- | if the correct brightness and contrast settings have been set?
- | if given display tolerances and compatibility have been considered?
- | if via the On Screen Menu you have performed a Factory Reset/Recall?

Before reporting the screen defect, please prepare the following information/evidence:

- | model number *
- | purchase receipt and serial number *
- | name and address for collection
- | telephone/fax number, for availability during the day
- | convenient collection date (date, time)
- | short description of the defect

Important Note:

If there is no fault found in the collected equipment after inspection, the transferring party shall incur charges for transport and administration.

If you have checked all of the above and there is still no picture, call our information line for assistance in your country.

* see the identification plate on the back of the case.

CE MARKING DECLARATION OF CONFORMITY

This LCD monitor complies with the requirements of the EC/EU Directive 2014/30/EU "EMC Directive", 2014/35/EU "Low Voltage Directive", 2009/125/EC "ErP Directive" and 2011/65/EU "RoHS Directive".

The electro-magnetic susceptibility has been chosen at a level that gives correct operation in residential areas, business and light industrial premises and small-scale enterprises, inside as well as outside of the buildings. All places of operation are characterised by their connection to the public low voltage power supply system.

IYAMA CORPORATION: Wijkerveerstraat 8, 2131 HA Hoofddorp, The Netherlands

Model No. : PL2788Q



We recommend recycling of used product. Please contact your dealer or iiyama service center. Recycle information is obtained via the Internet, using the address:
<http://www.iiyama.com>

You can access the Web page of different countries from there.

- We reserve the right to change specifications without notice.
- All trademarks used in this user manual are the property of their respective owners.

TABLE OF CONTENTS

FOR YOUR SAFETY	1
SAFETY PRECAUTIONS.....	1
SPECIAL NOTES ON LCD MONITORS	3
CUSTOMER SERVICE	3
CLEANING	3
BEFORE YOU OPERATE THE MONITOR	4
FEATURES.....	4
CHECKING THE CONTENTS OF THE PACKAGE	4
WALL MOUNTING	5
FITTING AND REMOVAL OF BASE : ProLite XB2788QS	6
FITTING AND REMOVAL OF BASE : ProLite X2788QS	7
CONTROLS AND CONNECTORS : ProLite XB2788QS	8
CONTROLS AND CONNECTORS : ProLite X2788QS.....	9
CONNECTING YOUR MONITOR : ProLite XB2788QS.....	10
CONNECTING YOUR MONITOR : ProLite X2788QS	11
COMPUTER SETTING	12
ADJUSTING THE HEIGHT AND THE VIEWING ANGLE :	
ProLite XB2788QS	12
ADJUSTING THE VIEWING ANGLE : ProLite X2788QS	13
OPERATING THE MONITOR.....	14
ADJUSTMENT MENU CONTENTS	15
POWER MANAGEMENT FEATURE.....	21
TROUBLE SHOOTING	22
RECYCLING INFORMATION.....	23
APPENDIX	24
SPECIFICATIONS : ProLite XB2788QS	24
SPECIFICATIONS : ProLite X2788QS.....	25
DIMENSIONS : ProLite XB2788QS	26
DIMENSIONS : ProLite X2788QS.....	26
COMPLIANT TIMING	27

FOR YOUR SAFETY

SAFETY PRECAUTIONS

WARNING

STOP OPERATING THE MONITOR IF YOU ARE AWARE OF ANY PROBLEMS

If you notice any abnormal phenomena such as smoke, strange sounds or fumes, unplug the monitor and contact your dealer or iiyama service center immediately. Further use may be dangerous and can cause fire or electric shock.

NEVER REMOVE THE CABINET

High voltage circuits are inside the monitor. Removing the cabinet may expose you to the danger of fire or electric shock.

DO NOT PUT ANY OBJECT INTO THE MONITOR

Do not put any solid objects or liquids such as water into the monitor. In case of an accident, unplug your monitor immediately and contact your dealer or iiyama service center. Using the monitor with any object inside may cause fire, electric shock or damage.

INSTALL THE MONITOR ON A FLAT, STABLE SURFACE

The monitor may cause an injury if it falls or is dropped.

DO NOT USE THE MONITOR NEAR WATER

Do not use where water may be splashed or spilt onto the monitor as it may cause fire or electric shock.

OPERATE UNDER THE SPECIFIED POWER SUPPLY

Be sure to operate the monitor only with the specified power supply. Use of an incorrect voltage will cause malfunction and may cause fire or electric shock.

PROTECT THE CABLES

Do not pull or bend the power cable and signal cable. Do not place the monitor or any other heavy objects on the cables. If damaged, the cables may cause fire or electric shock.

ADVERSE WEATHER CONDITIONS

It is advisable not to operate the monitor during a heavy thunder storm as the continual breaks in power may cause malfunction. It is also advised not to touch the plug in these circumstances as it may cause electric shock.

CAUTION

INSTALLATION LOCATION

Do not install the monitor where sudden temperature changes may occur, or in humid, dusty or smoky areas as it may cause fire, electric shock or damage. You should also avoid areas where the sun shines directly on the monitor.

DO NOT PLACE THE MONITOR IN A HAZARDOUS POSITION

The monitor may topple and cause injury if not suitably located. Please also ensure that you do not place any heavy objects on the monitor, and that all cables are routed such that children may not pull the cables and possibly cause injury.

MAINTAIN GOOD VENTILATION

Ventilation slots are provided to keep the monitor from overheating. Covering the slots may cause fire. To allow adequate air circulation, place the monitor at least 10 cm (or 4 inches) from any walls. Do not remove the tilt stand when operating the monitor. Ventilation slots on the back of the cabinet will be blocked and the monitor may overheat if the stand is removed. This may cause fire or damage. Operating the monitor on its back, side, upside down or on a carpet or any other soft material may also cause damage.

DISCONNECT THE CABLES WHEN YOU MOVE THE MONITOR

When you move the monitor, turn off the power switch, unplug the monitor and be sure the signal cable is disconnected. If you do not disconnect them, it may cause fire or electric shock.

UNPLUG THE MONITOR

If the monitor is not in use for a long period of time it is recommended that it is left unplugged to avoid accidents.

HOLD THE PLUG WHEN DISCONNECTING

To disconnect the power cable or signal cable, always pull it by the plug. Never pull on the cable itself as this may cause fire or electric shock.

DO NOT TOUCH THE PLUG WITH WET HANDS

Pulling or inserting the plug with wet hands may cause electric shock.

WHEN YOU INSTALL THE MONITOR ON YOUR COMPUTER

Be sure the computer is strong enough to hold the weight of the monitor, otherwise, you may damage your computer.

CAREFUL! PROTECT YOUR HANDS AND FINGERS

- Be careful not to hurt your fingers or hands when you change the height or the angle.
- Injury can occur if care is not taken to avoid finger contact with the displays base when adjusting the height. (Just for height adjustable model.)

REMARK FOR 24/7 USAGE

This product is not specifically designed for 24/7 usage in all environments.

OTHERS

ERGONOMIC RECOMMENDATIONS

To eliminate eye fatigue, do not operate the monitor against a bright background or in a dark room. For optimal viewing comfort, the monitor should be just below eye level and 40-60 cm (16-24 inches) away from your eyes. When using the monitor over a prolonged time, a ten minute break every hour is recommended as looking at the screen continuously can cause eye strain.

SPECIAL NOTES ON LCD MONITORS

The following symptoms are normal with LCD monitors and do not indicate a problem.

- NOTE**
- When you first turn on the LCD monitor, the picture may not fit in the display area because of the type of computer that is used. In this case, adjust the picture position to the correct position.
 - You may find slightly uneven brightness on the screen depending on the desktop pattern you use.
 - Due to the nature of the LCD screen, an afterimage of the previous screen may remain after switching the image, when the same image is displayed for hours. In this case, the screen can be recovered slowly by changing the image or turning off the Power Switch for some hours.

CUSTOMER SERVICE

- NOTE**
- If you have to return your unit for service and the original packaging has been discarded, please contact your dealer or iiyama service center for advice or replacement packaging.

CLEANING

- WARNING**
- If you drop any materials or liquids such as water into the monitor when cleaning, unplug the power cable immediately and contact your dealer or iiyama service center.

- CAUTION**
- For safety reasons, turn off the power switch and unplug the monitor before you clean it.

- NOTE**
- To protect the LCD panel, do not scratch or rub the screen with a hard object.
 - Never use any of the following strong solvents. These will damage the cabinet and the LCD screen.

Thinner	Spray-type cleaner
Benzine	Wax
Abrasive cleaner	Acid or Alkaline solvent

- Touching the cabinet with any product made from rubber or plastic for a long time may cause degeneration or loss of paint on the cabinet.

CABINET Stains can be removed with a cloth lightly moistened with a mild detergent solvent. Then wipe the cabinet with a soft dry cloth.

LCD Periodic cleaning with a soft dry cloth is recommended.

SCREEN Don't use tissue paper etc. because these will damage the LCD screen.

BEFORE YOU OPERATE THE MONITOR

FEATURES

- ◆ Supports Resolutions up to 2880 × 1620 (Native Resolution 2560 × 1440)
- ◆ High Contrast 1000:1 (Typical), Adv. Contrast Function Available / Brightness 350cd/m² (Typical) / Quick Response Time 5ms (Gray to Gray)
- ◆ Supports AMD FreeSync™ technology (through HDMI/DisplayPort-input)
- ◆ Flicker - Free
- ◆ Blue Light Reducer
- ◆ Digital Character Smoothing
- ◆ Stereo Speakers
2 × 2.5W Stereo Speakers
- ◆ Plug & Play VESA DDC2B Compliant
Windows® Vista/7/8/8.1/10 Compliant
- ◆ Power Management (VESA DPMS Compliant)
- ◆ VESA Mounting Standard (100mm×100mm) Compliant
- ◆ Keyhole for Security Lock

CHECKING THE CONTENTS OF THE PACKAGE

The following accessories are included in your package. Check to see if they are enclosed with the monitor. If anything is missing or damaged, please contact your local iiyama dealer or regional iiyama office.

- Power Cable*¹
- Stand Base
- Quick Start Guide
- HDMI Cable
- Screw for stand fixing (3pcs)*²
- DisplayPort Cable
- Safety Guide

CAUTION

*¹ The rating of the Power Cable enclosed in 120V area is 10A/125V. If you are using a power supply higher than this rating, then a power cable with a rating of 10A/250V must be used. However, all guarantees and warranties are void for any problems or damage caused by a power cable not supplied by iiyama.

*² Accessory for ProLite XB2788QS.

WALL MOUNTING

- WARNING**
- When you use with the wall mounting, in consideration of thickness of the mounting stage, tighten the M4 Screw with washer which “L” length is 7mm to fasten the monitor. Using the screw longer than this may cause electric shock or damage because it may contact with the electrical parts inside the monitor.
 - Please check if the wall or ceiling can support the weight of the monitor before mounting it.

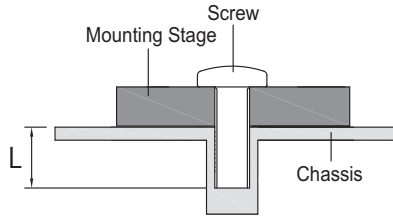

FITTING AND REMOVAL OF BASE : ProLite XB278QS

CAUTION

- Put the monitor on a stable surface. The monitor may cause injury or damage if it falls or is dropped.
- Do not give a strong impact to the monitor. It may cause damage.
- Unplug the monitor before removal or installation to avoid electric shock or damage.

<Installation>

- ① Put a piece of soft cloth on the table beforehand to prevent the monitor from being scratched.
Lay the monitor flat on a table with front face down.
- ② Hold the monitor and push the Stand-Base.
- ③ Use 'thumb screw' provided to secure base to monitor column.

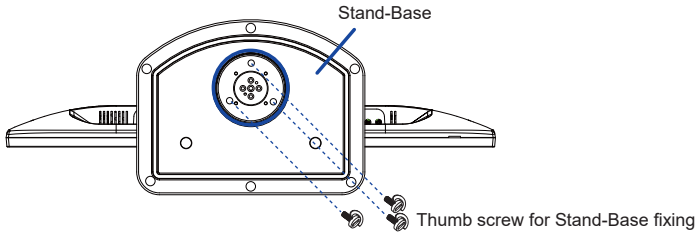

<Removal>

- ① Put a piece of soft cloth on the table beforehand to prevent the monitor from being scratched.
Lay the monitor flat on a table with front face down.
- ② Remove 'thumb screw' to remove base from monitor column.

<Stopper>

Put the monitor on a flat surface. Press the stopper at the back of the stand while pushing the monitor from the top. Careful attention is required as the monitor is sprung loaded and the stand may expand quickly.

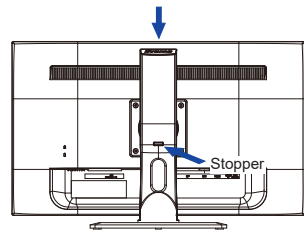

FITTING AND REMOVAL OF BASE : ProLite X278QS

- CAUTION**
- Put the monitor on a stable surface. The monitor may cause injury or damage if it falls or is dropped.
 - Do not give a strong impact to the monitor. It may cause damage.
 - Unplug the monitor before removal or installation to avoid electric shock or damage.

<Installation>

- ① Put a piece of soft cloth on the table beforehand to prevent the monitor from being scratched.
Lay the monitor flat on a table with front face down.
- ② Hold the monitor and push the Stand-Base until it clicks and is secure.

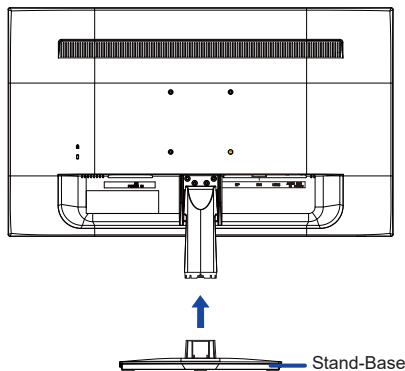

<Removal>

- ① Put a piece of soft cloth on the table beforehand to prevent the monitor from being scratched.
Lay the monitor flat on a table with front face down.
- ② Press and hold the hooks inside, and pull the Stand-Base.

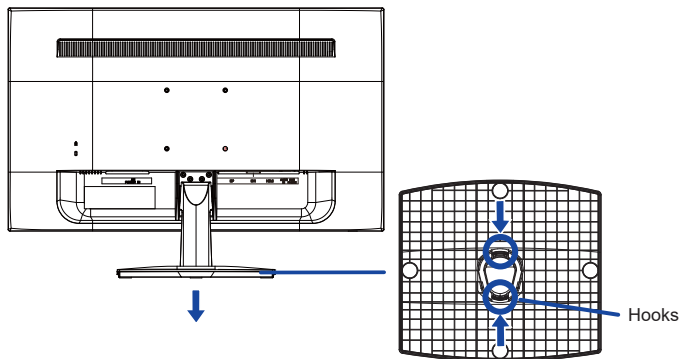

CONTROLS AND CONNECTORS : ProLite XB2788QS

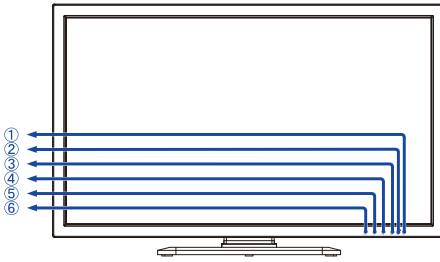

<Front>

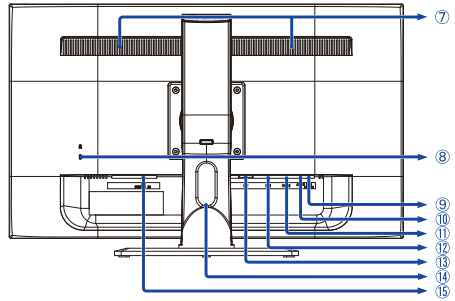

<Back>

- ① Power Switch (⏻)
- ② Power Indicator
NOTE Blue: Normal operation
Orange: Power Management
- ③ Input / Select Button (INPUT/SELECT)*
- ④ Scroll up / Audio Adjust Button (▶ / 🔊)*
- ⑤ Scroll down / i-Style Color Button (◀ / i)*
- ⑥ Menu Button (MENU/EXIT)
- ⑦ Speakers
- ⑧ Keyhole for Security Lock
NOTE You can fasten a security lock and cable to prevent the monitor from being removed without your permission.
- ⑨ Headphone Connector (EARPHONE)
- ⑩ Audio Connector (AUDIO IN)
- ⑪ HDMI Connector (HDMI)
- ⑫ DVI-D 24pin Connector (DVI)
- ⑬ DisplayPort Connector (DP)
- ⑭ Cable Holes
- ⑮ AC Connector (~ : Alternating current) (AC POWER IN)

* You can skip the Menu items and display an adjustment scale directly.



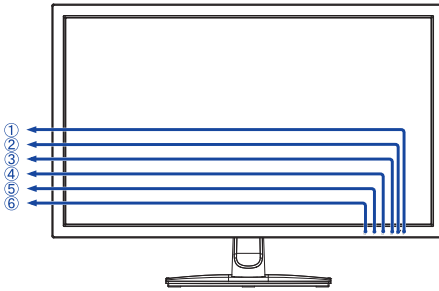

CONTROLS AND CONNECTORS : ProLite X2788QS

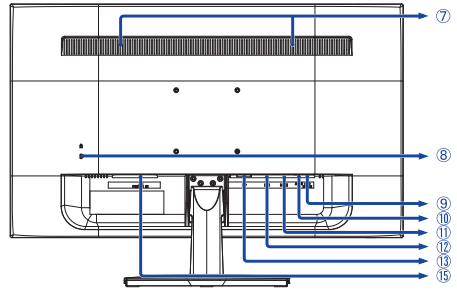

<Front>



<Back>

- ① Power Switch ()
- ② Power Indicator
- ③ Input / Select Button (INPUT/SELECT)*
- ④ Scroll up / Audio Adjust Button ( / )*
- ⑤ Scroll down / i-Style Color Button ( / )*
- ⑥ Menu Button (MENU/EXIT)

⑦ Speakers

⑧ Keyhole for Security Lock

NOTE You can fasten a security lock and cable to prevent the monitor from being removed without your permission.

⑨ Headphone Connector (EARPHONE)

⑩ Audio Connector (AUDIO IN)

⑪ HDMI Connector (HDMI)

⑫ DVI-D 24pin Connector (DVI)

⑬ DisplayPort Connector (DP)

⑮ AC Connector ( : Alternating current) (AC POWER IN)

* You can skip the Menu items and display an adjustment scale directly.

CONNECTING YOUR MONITOR : ProLite XB2788QS

- ① Ensure that both the computer and the monitor are switched off.
- ② Connect the computer to the monitor with the signal cable.
- ③ Connect the monitor to the audio equipment with the Audio Cable for computer when using the audio features.
- ④ Connect the Power Cable to the monitor first and then to the power supply.
- ⑤ Turn on your monitor and computer.

NOTE

- The signal cables used for connecting the computer and monitor may vary with the type of computer used. An incorrect connection may cause serious damage to both the monitor and the computer. The cable supplied with the monitor is for a standard connector. If a special cable is required please contact your local iiyama dealer or regional iiyama office.
- For connection to Macintosh computers, contact your local iiyama dealer or regional iiyama office for a suitable adaptor.
- Make sure you tighten the finger screws at each end of the signal cable.
- Excessive sound pressure from ear-/headphones can cause hearing damage/hearing loss.

[Example of Connection]

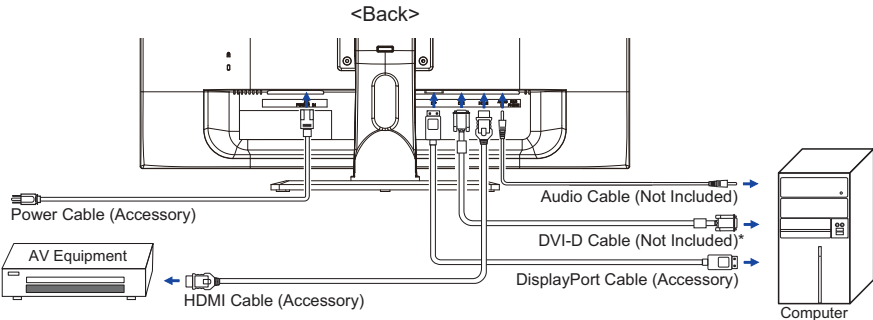

* DVI dual-link cable is not supplied with the monitor. If you use low quality DVI dual-link cable, it may cause a result of electro-magnetic interference. Please contact the iiyama Support Centre in your country if you wish to connect the monitor via the DVI input.

[Collect Cables]

- ① Put the cables through the cable hole.
- ② Collect cables at the back of the stand.

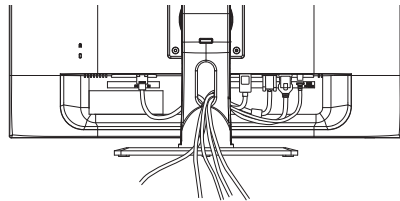

CONNECTING YOUR MONITOR : ProLite X2788QS

- ① Ensure that both the computer and the monitor are switched off.
- ② Connect the computer to the monitor with the signal cable.
- ③ Connect the monitor to the audio equipment with the Audio Cable for computer when using the audio features.
- ④ Connect the Power Cable to the monitor first and then to the power supply.
- ⑤ Turn on your monitor and computer.

NOTE

- The signal cables used for connecting the computer and monitor may vary with the type of computer used. An incorrect connection may cause serious damage to both the monitor and the computer. The cable supplied with the monitor is for a standard connector. If a special cable is required please contact your local iiyama dealer or regional iiyama office.
- For connection to Macintosh computers, contact your local iiyama dealer or regional iiyama office for a suitable adaptor.
- Make sure you tighten the finger screws at each end of the signal cable.
- Excessive sound pressure from ear-/headphones can cause hearing damage/hearing loss.

[Example of Connection]

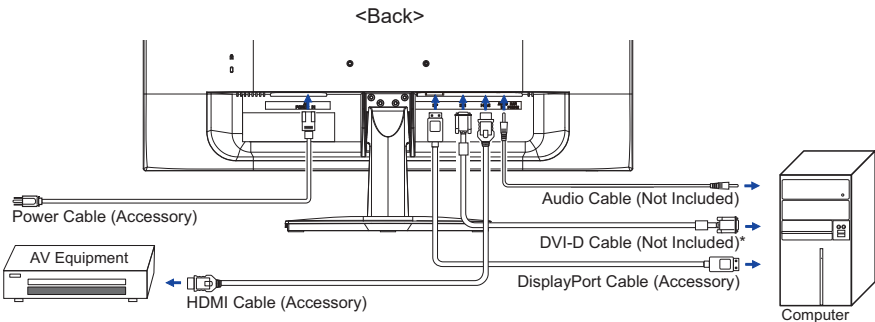

- * DVI dual-link cable is not supplied with the monitor. If you use low quality DVI dual-link cable, it may cause a result of electro-magnetic interference. Please contact the iiyama Support Centre in your country if you wish to connect the monitor via the DVI input.

COMPUTER SETTING

■ Signal Timing

Change to the desired signal timing listed on page 27: COMPLIANT TIMING.

ADJUSTING THE HEIGHT AND THE VIEWING ANGLE : ProLite XB2788QS

- For optimal viewing it is recommended to position yourself directly opposite to the full face of the monitor, then adjust the monitor's height and angle to your own preference.
- Hold the panel so that the monitor does not topple when you change the monitor's height or angle.
- You are able to adjust the monitor's height up to 130mm, angle up to 45 degrees right and left, 17 degrees upward.

NOTE

- Do not touch the LCD screen when you change the height or the angle. It may cause damage or break the LCD screen.
- Careful attention is required not to catch your fingers or hands when you change the height or the angle.
- Injury can occur if care is not taken to avoid finger contact with the displays base when adjusting the height.

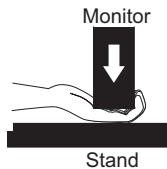
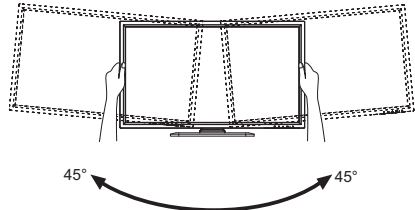
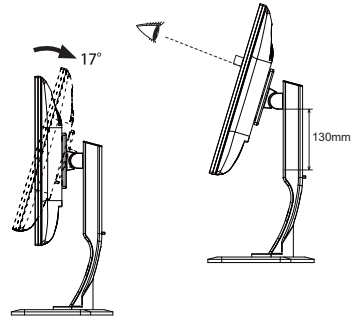

ADJUSTING THE VIEWING ANGLE : ProLite X2788QS

- For optimal viewing it is recommended to look at the full face of the monitor.
- Hold the stand so that the monitor does not topple when you change the monitor's angle.
- You are able to adjust the monitor's angle up to 20° upward, 3° downward.
- In order to ensure a healthy and relaxed body position when using the monitor at visual display workstations, it is recommended that the adjusted tilt angle should not exceed 10 degrees. Adjust the monitor's angle to your own preference.

NOTE

- Do not touch the LCD screen when you change the angle. It may cause damage or break the LCD screen.
- Careful attention is required not to catch your fingers or hands when you change the angle.

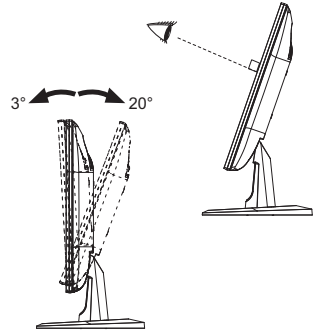

OPERATING THE MONITOR

To create the best picture, your iiyama LCD monitor has been preset at the factory with the COMPLIANT TIMING shown on page 27. You are also able to adjust the picture by following the button operation shown below.

- 1 Press the MENU Button to start the On Screen Display (OSD) feature. There are additional Menu items which can be switched by using the ◀/▶ Buttons.

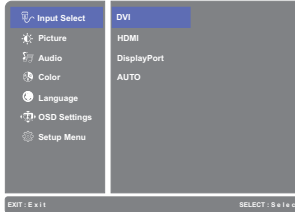

- 2 Select the Menu item which contains the adjustment icon relating to the adjustment you want to make. Press the SELECT Button. Then, use the ◀/▶ Buttons to highlight the desired adjustment icon.
- 3 Press the SELECT Button again. Use the ◀/▶ Buttons to make the appropriate adjustment or setting.
- 4 Press the EXIT Button to leave the menu, and the settings you just made would be automatically saved.

For example, to correct for OSD vertical position, select Menu item of (OSD Settings) and then press the SELECT Button. Then, select OSD V. Position by using the ◀/▶ Buttons.

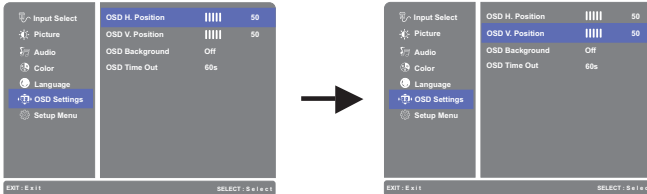

An adjustment page appears after you press the SELECT Button. Then, use the ◀/▶ Buttons to change the vertical position settings. The vertical position should be changing accordingly while you are doing this.



Press the EXIT Button lastly, it ends, all changes are saved in the memory.

NOTE

- When button operations are aborted during adjustment, On-Screen Display disappears when the time set for the OSD Time Out has passed. Also, the MENU button can be used to return previous menu and turn off the On-Screen Display.
- Any changes are automatically saved in the memory when the On Screen Display disappears. Turning off the power should be avoided while using the Menu.

ADJUSTMENT MENU CONTENTS

















Input Select Direct		
Adjustment Item	Problem / Option	Button to Press
Input Select	DVI	Select the DVI input.
	HDMI	Select the HDMI input.
	DisplayPort	Select the DisplayPort input.
	AUTO	Search for an available input source and select automatically.

NOTE However it will automatically be selected when just one source is using.
In Power Management Mode input switching is disabled.
Input source is fixed, not selected automatically when DVI, HDMI and DisplayPort which are selected.

Direct

You can skip the Menu items and display an adjustment scale directly by using the following button operations.

- Input Select: Press the INPUT Button when the Menu is not displayed.

 Picture			
Adjustment Item	Problem / Option		Button to Press
Brightness *1,2	Too dark Too bright		   
Contrast *2	Too dull Too intense		   
Sharpness	You can change the picture quality from 0 to 100 (soft to sharp). Press the ◀ Button to change the picture quality in numerical order. Press the ▶ Button to change the picture quality in reverse numerical order. Adjust the picture quality at resolutions of less than 2560 × 1440. You can change the picture quality.		   
Overdrive *2	Off / -2 / -1 / 0 / +1 / +2 It will improve the gray level response time of the LCD panel. A higher level results in a faster response time.		   
Adv. Contrast *2	On	Increased Contrast Ratio	
	Off	Typical Contrast Ratio	
ECO Mode *2	Off	Normal	
	1	Brightness of back-light is reduced.	
	2	Brightness of back-light is reduced more than 1.	
	3	Brightness of back-light is reduced more than 2.	
Blue Light Reducer *2 Direct	Off	Typical	
	1	Blue light is reduced.	
	2	Blue light is reduced more than Mode1.	
	3	Blue light is reduced more than Mode2.	



*1 Adjust the Brightness when you are using the monitor in a dark room and feel the screen is too bright.

*2 See page 21 for Disabled function matrix.

Direct

You can skip the Menu items and display an adjustment scale directly by using the following button operations.



- Blue Light Reducer: Pressing and holding of the INPUT Button for about 2 seconds when the Menu is not displayed.



 Audio Direct			
Adjustment Item	Problem / Option		Button to Press
Volume	Too soft		
	Too loud		
Mute Direct	On	Turn off the sound temporarily.	
	Off	Return the sound volume to the previous level.	
Audio Input *	Line-In	Select the Line-In input.	
	HDMI	Select the HDMI input.	
	DisplayPort	Select the DisplayPort input.	

* Suitable for HDMI/DisplayPort input only.

Direct

You can skip the Menu items and display an adjustment scale directly by using the following button operations.

- Audio: Press the  Button when the Menu is not displayed.
- Mute: Pressing and holding of the  Button for about 2 seconds when the Menu is not displayed.
Mute and Unmute are switched as follows by pressing the  Button successively.

 Color *			
Adjustment Item	Problem / Option		Button to Press
Warm	Reddish white		
Normal	Greenish white		
Cool	Bluish white		
User Color	Red	Too weak	
	Green	Too strong	
	Blue		
i-Style Color Direct	Off	Return to a state set by color adjustment except i-Style Color.	
	Standard	For general windows environment and monitor default setting.	
	Game	For PC game environment.	
	Cinema	For movie and video environment.	
	Scenery	For displaying outdoor scenery images	
	Text	For text editing and viewing in a word processing environment.	











* See page 21 for Disabled function matrix.

Direct

You can skip the Menu items and display an adjustment scale directly by using the following button operations.

- i-Style Color : Press the i Button when the Menu is not displayed.

 Language			
Adjustment Item	Problem / Option		Button to Press
Language	English	English	Česky / Czech
	Français	French	Русский / Russian
	Deutsch	German	日本語 / Japanese
	Nederlands	Dutch	简体中文 / Simplified Chinese
	Polski	Polish	繁體中文 / Traditional Chinese
	Italiano	Italian	

 OSD Settings		
Adjustment Item	Problem / Option	Button to Press
OSD H. Position	OSD is too left	 
	OSD is too right	 
OSD V. Position	OSD is too low	 
	OSD is too high	 
OSD Background	On	The background of OSD is mode transparent.
	Off	The OSD Background is turned Off.
OSD Time Out	You can set the OSD display duration time. 5 / 15 / 30 / 60 seconds	 

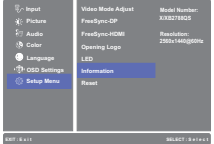
 Setup Menu			
Adjustment Item	Problem / Option		Button to Press
Video Mode Adjust	Full Screen	Full screen display	
	Aspect Ratio *	Expansion display of Aspect	
	Dot by Dot	Display the picture dot by dot.	
FreeSync-DP	On	Enable the FreeSync function on DP.	
	Off	The FreeSync function on DP is turned off.	
FreeSync-HDMI	On	Enable the FreeSync function on HDMI.	
	Off	The FreeSync function on HDMI is turned off.	
Opening Logo	On	iiyama Logo displayed when the monitor is turned on.	
	Off	iiyama Logo does not display when the monitor is turned on.	
LED	On	The Power Indicator is turned On.	
	Off	The Power Indicator is turned Off.	
NOTE Turn Off the Power Indicator when you are bothered by the light.			
Information	Displays information regarding the current input signal coming from the graphic card in your computer. <Example> <div style="display: flex; align-items: center; margin-top: 10px;">  <div style="margin-left: 20px;"> NOTE See your graphic card user guide for more information about changing the resolution and refresh. </div> </div>		
Reset	Factory-preset data is restored.		

* Option unavailable with 16:9 resolution.

● **Lock Mode**

<OSD Menu>

1. The OSD lock will be activated by pressing the front buttons MENU and ► for about 5 seconds. If you try to access the OSD by pressing any of the buttons MENU, ◀, ► and INPUT, message "OSD Locked" will appear on the screen.
2. The OSD lock will be deactivated by pressing the front buttons MENU and ► again for 5 seconds.

<Power Switch>

1. The power switch lock will be activated by pressing the front buttons MENU and ◀ for 10 seconds. Locking the power switch means that won't be able to turn off the Monitor while the power switch is locked. If presses the power switch message "Power Button Locked" will appear on the screen.
2. The power switch lock will be deactivated by pressing the front buttons MENU and ◀ again for about 10 seconds.

■ **Disabled function matrix**

		After enabled function						
		Adv. Contrast	ECO Mode	Color	Blue Light Reducer	Brightness	Contrast	Overdrive
Function enabled	Adv. Contrast	—	×	○	×	×	○	○
	ECO Mode	×	—	○	○	×	○	○
	i-Style Color	×	×	—	×	×	×	○
	Blue Light Reducer	×	×	×	—	×	○	○

○ : adjustable
 × : disabled

POWER MANAGEMENT FEATURE

The power management feature of this product complies with power saving requirement of VESA DPMS. When activated, it automatically reduces unnecessary power consumption of the monitor when your computer is not in use.

To use the feature, the monitor needs to be connected to a VESA DPMS compliant computer. There is a power management step the monitor takes as described below. The power management function, including any timer settings is configured by the operating system. Check your operating system manual for information on how this can be configured.

■ Power Management Mode

When the H-sync signal / V-sync signal / H and V sync signals from the computer are off, the monitor enters into Power Management Mode which reduces the power consumption to less than 0.5W. The screen becomes dark, and the power indicator turns to orange. From Power Management Mode, the image reappears in several seconds when either the keyboard or the mouse are touched again.

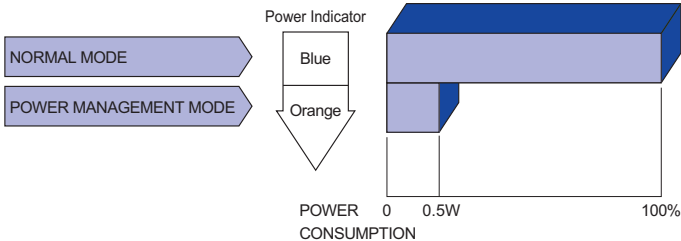

NOTE

- Even when using the power management mode, the monitor consumes electricity. Turn off the Power Switch whenever the monitor is not in use, during the night and weekends, to avoid unnecessary power consumption.
- It is possible that the video signal from the computer may be on while the H or V sync signal is missing. In this instance, the POWER MANAGEMENT feature may not work properly.

TROUBLE SHOOTING

If the monitor fails to operate correctly, please follow the steps below for a possible solution.

1. Perform the adjustments described in OPERATING THE MONITOR, depending on the problem you have. If the monitor does not get a picture, skip to 2.
2. Consult the following items if you cannot find an appropriate adjustment item in OPERATING THE MONITOR or if the problem persists.
3. If you are experiencing a problem which is not described below or you cannot correct the problem, discontinue using the monitor and contact your dealer or iiyama service center for further assistance.

Problem	Check
① The picture does not appear. (Power indicator does not light up.) (Power indicator is blue.) (Power indicator is orange.)	<input type="checkbox"/> The Power Cable is firmly seated in the socket. <input type="checkbox"/> The Power Switch is turned ON. <input type="checkbox"/> The AC socket is live. Please check with another piece of equipment. <input type="checkbox"/> If the blank screen saver is in active mode, touch the keyboard or the mouse. <input type="checkbox"/> Increase the Contrast and/or Brightness. <input type="checkbox"/> The computer is ON. <input type="checkbox"/> The Signal Cable is properly connected. <input type="checkbox"/> The signal timing of the computer is within the specification of the monitor. <input type="checkbox"/> If the monitor is in power management mode, touch the keyboard or the mouse. <input type="checkbox"/> The computer is ON. <input type="checkbox"/> The Signal Cable is properly connected. <input type="checkbox"/> The signal timing of the computer is within the specification of the monitor.
② The screen is not synchronized.	<input type="checkbox"/> The Signal Cable is properly connected. <input type="checkbox"/> The signal timing of the computer is within the specification of the monitor. <input type="checkbox"/> The video output level of the computer is within the specification of the monitor.
③ The screen position is not in the center.	<input type="checkbox"/> The signal timing of the computer is within the specification of the monitor.
④ The screen is too bright or too dark.	<input type="checkbox"/> The video output level of the computer is within the specification of the monitor.
⑤ The screen is shaking.	<input type="checkbox"/> The power voltage is within the specification of the monitor. <input type="checkbox"/> The signal timing of the computer is within the specification of the monitor.

Problem**Check**

- | | |
|---------------------------------------|--|
| ⑥ No sound. | <input type="checkbox"/> The audio equipment (computer etc.) is ON. |
| | <input type="checkbox"/> The Audio Cable is properly connected. |
| | <input type="checkbox"/> The Volume is turned up. |
| | <input type="checkbox"/> The Mute is OFF. |
| | <input type="checkbox"/> The audio output level of the audio equipment is within the specification of the monitor. |
| ⑦ The sound is too loud or too quiet. | <input type="checkbox"/> The audio output level of the audio equipment is within the specification of the monitor. |
| ⑧ A strange noise is heard. | <input type="checkbox"/> The Audio Cable is properly connected. |

RECYCLING INFORMATION

For better environment protection please don't dispose your monitor.
Please visit our web site: www.iiyama.com/recycle for monitor recycling.

APPENDIX

Design and specifications are subject to change without prior notice.

SPECIFICATIONS : ProLite XB2788QS

Size Category		27"
LCD Panel	Panel technology	IPS Panel Technology
	Size	Diagonal: 27" (68.5cm)
	Pixel pitch	0.233mm H × 0.233mm V
	Brightness	350cd/m ² (Typical)
	Contrast ratio	1000 : 1 (Typical), Adv. Contrast Function Available
	Viewable angle	Right / Left : 89 degrees each, Up / Down: 89 degrees each (Typical)
	Response time	5ms (Gray to Gray)
Display Colors		DVI : Approx. 16.7M HDMI/DisplayPort : Approx. 1.07B
Sync Frequency		DVI : Horizontal: 30.0-100.0kHz, Vertical: 55-75Hz HDMI (FreeSync: Off) : Horizontal: 30.0-90.0kHz, Vertical: 50-75Hz HDMI (FreeSync: On) : Horizontal: 30.0-90.0kHz, Vertical: 40-60Hz DisplayPort (FreeSync: Off) : Horizontal: 30.0-100.0kHz, Vertical: 50-75Hz DisplayPort (FreeSync: On) : Horizontal: 30.0-100.0kHz, Vertical: 40-60Hz
Native Resolution		2560 × 1440, 3.7 MegaPixels
Supported max. resolution		DVI : 2880 × 1620 60Hz HDMI (FreeSync: Off) : 2560 × 1440 60Hz HDMI (FreeSync: On) : 2560 × 1440 60Hz DisplayPort (FreeSync: Off) : 2880 × 1620 60Hz DisplayPort (FreeSync: On) : 2880 × 1620 60Hz
Input Connector		DVI-D 24 pin, HDMI, DisplayPort
Plug & Play		VESA DDC2B™
Input Video Signal		Digital: DVI (Digital Visual Interface Standard Rev.1.0) compliance Digital: HDMI Digital: DisplayPort
Input Audio Connector		ø 3.5mm mini jack (Stereo)
Input Audio Signal		1.0Vrms maximum
Headphone Connector		ø 3.5mm mini jack (Stereo)
Speakers		2.5W × 2 (Stereo speakers)
Maximum Screen Size		596.7mm W × 335.7mm H / 23.5" W × 13.2" H
Power Source		100-240VAC, 50/60Hz, 1.0A
Power Consumption*		41W typical, Power management mode: 0.5W maximum Energy Efficiency Class: C
Dimensions / Net Weight		643.5 × 412.0 - 542.0 × 230.0mm / 25.3 × 16.2 - 21.3 × 9.1" (W×H×D) 6.2kg / 13.66lbs
Tilt Angle		Upward: 17 degrees, Left/Right: 45 degrees each
Environmental Considerations		Operating: Temperature 5 to 35°C / 41 to 95°F Humidity 10 to 80% (No condensation) Storage: Temperature -20 to 60°C / -4 to 140°F Humidity 5 to 85% (No condensation)
Approvals		CE, TÜV-Bauart, CU, VCCI-B, PSE

NOTE * Audio equipment are not connected.

SPECIFICATIONS : ProLite X2788QS

Size Category		27"
LCD Panel	Panel technology	IPS Panel Technology
	Size	Diagonal: 27" (68.5cm)
	Pixel pitch	0.233mm H × 0.233mm V
	Brightness	350cd/m ² (Typical)
	Contrast ratio	1000 : 1 (Typical), Adv. Contrast Function Available
	Viewable angle	Right / Left : 89 degrees each, Up / Down: 89 degrees each (Typical)
	Response time	5ms (Gray to Gray)
Display Colors		DVI : Approx. 16.7M HDMI/DisplayPort : Approx. 1.07B
Sync Frequency		DVI : Horizontal: 30.0-100.0kHz, Vertical: 55-75Hz HDMI (FreeSync: Off) : Horizontal: 30.0-90.0kHz, Vertical: 50-75Hz HDMI (FreeSync: On) : Horizontal: 30.0-90.0kHz, Vertical: 40-60Hz DisplayPort (FreeSync: Off) : Horizontal: 30.0-100.0kHz, Vertical: 50-75Hz DisplayPort (FreeSync: On) : Horizontal: 30.0-100.0kHz, Vertical: 40-60Hz
Native Resolution		2560 × 1440, 3.7 MegaPixels
Supported max. resolution		DVI : 2880 x 1620 60Hz HDMI (FreeSync: Off) : 2560 x 1440 60Hz HDMI (FreeSync: On) : 2560 x 1440 60Hz DisplayPort (FreeSync: Off) : 2880 x 1620 60Hz DisplayPort (FreeSync: On) : 2880 x 1620 60Hz
Input Connector		DVI-D 24 pin, HDMI, DisplayPort
Plug & Play		VESA DDC2B™
Input Video Signal		Digital: DVI (Digital Visual Interface Standard Rev.1.0) compliance Digital: HDMI Digital: DisplayPort
Input Audio Connector		ø 3.5mm mini jack (Stereo)
Input Audio Signal		1.0Vrms maximum
Headphone Connector		ø 3.5mm mini jack (Stereo)
Speakers		2.5W × 2 (Stereo speakers)
Maximum Screen Size		596.7mm W × 335.7mm H / 23.5" W × 13.2" H
Power Source		100-240VAC, 50/60Hz, 1.0A
Power Consumption*		41W typical, Power management mode: 0.5W maximum Energy Efficiency Class: C
Dimensions / Net Weight		643.5 × 462.0 × 242.0mm / 25.3 × 18.2 × 9.5" (W×H×D) 4.4kg / 9.70lbs
Tilt Angle		Upward: 20 degrees, Downward: 3 degrees
Environmental Considerations		Operating: Temperature 5 to 35°C / 41 to 95°F Humidity 10 to 80% (No condensation) Storage: Temperature -20 to 60°C / -4 to 140°F Humidity 5 to 85% (No condensation)
Approvals		CE, TÜV-Bauart, CU, VCCI-B, PSE

NOTE * Audio equipment are not connected.

DIMENSIONS : ProLite XB2788QS

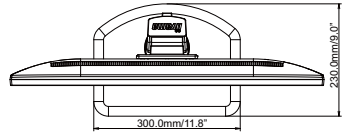
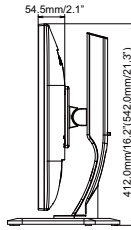
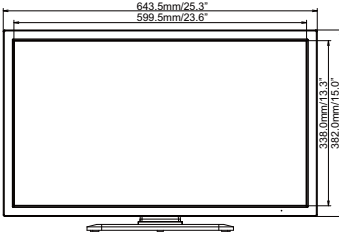

() : Maximum adjustment range

* Protruding portion(s) not included.

ENGLISH

DIMENSIONS : ProLite X2788QS

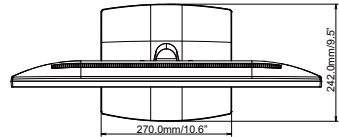
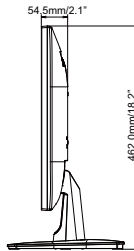
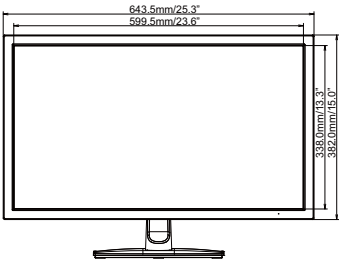

* Protruding portion(s) not included.

COMPLIANT TIMING

Video Mode			Horizontal Frequency	Vertical Frequency	Dot Clock
VESA	VGA	640 × 480	31.469kHz	59.940Hz	25.175MHz
			37.500kHz	75.000Hz	31.500MHz
	SVGA	800 × 600	37.879kHz	60.317Hz	40.000MHz
			46.875kHz	75.000Hz	49.500MHz
	XGA	1024 × 768	48.363kHz	60.004Hz	65.000MHz
			60.023kHz	75.029Hz	78.750MHz
	SXGA	1280 × 1024	63.981kHz	60.020Hz	108.000MHz
			79.976kHz	75.025Hz	135.000MHz
	Full HD	1920 × 1080	67.500kHz	60.000Hz	148.500MHz
	QWXGA	2048 × 1152	71.584kHz	60.000Hz	197.000MHz
WQHD	2560 × 1440	88.787kHz	59.951Hz	241.500MHz	
	2880 × 1620	99.960kHz	60.000Hz	303.880MHz	

NOTE *1 DVI and DisplayPort input only.

*2 DVI : Use the DVI-D dual-link signal cable.

*3 As the picture is compressed, texts and lines will become thinner.