

**ASUS**<sup>®</sup>

**PA329 Series  
LCD Monitor**

*User Guide*

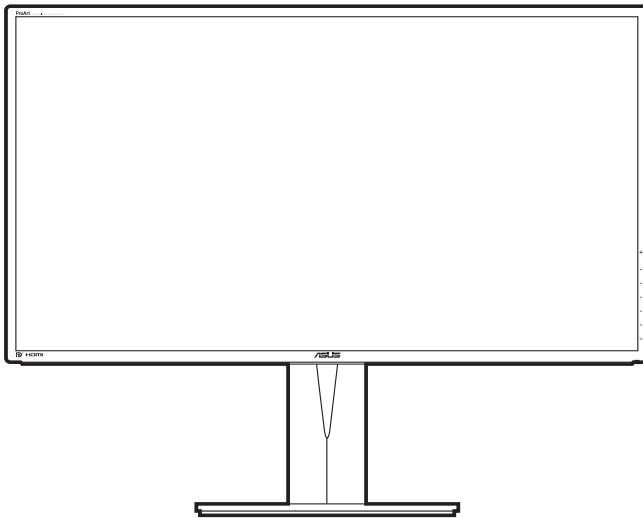

**HDMI**<sup>™</sup>  
HIGH DEFINITION MULTIMEDIA INTERFACE

First Edition  
January 2016

**Copyright © 2016 ASUSTeK COMPUTER INC. All Rights Reserved.**

No part of this manual, including the products and software described in it, may be reproduced, transmitted, transcribed, stored in a retrieval system, or translated into any language in any form or by any means, except documentation kept by the purchaser for backup purposes, without the express written permission of ASUSTeK COMPUTER INC. ("ASUS").

Product warranty or service will not be extended if: (1) the product is repaired, modified or altered, unless such repair, modification or alteration is authorized in writing by ASUS; or (2) the serial number of the product is defaced or missing.

ASUS PROVIDES THIS MANUAL "AS IS" WITHOUT WARRANTY OF ANY KIND, EITHER EXPRESS OR IMPLIED, INCLUDING BUT NOT LIMITED TO THE IMPLIED WARRANTIES OR CONDITIONS OF MERCHANTABILITY OR FITNESS FOR A PARTICULAR PURPOSE. IN NO EVENT SHALL ASUS, ITS DIRECTORS, OFFICERS, EMPLOYEES OR AGENTS BE LIABLE FOR ANY INDIRECT, SPECIAL, INCIDENTAL, OR CONSEQUENTIAL DAMAGES (INCLUDING DAMAGES FOR LOSS OF PROFITS, LOSS OF BUSINESS, LOSS OF USE OR DATA, INTERRUPTION OF BUSINESS AND THE LIKE), EVEN IF ASUS HAS BEEN ADVISED OF THE POSSIBILITY OF SUCH DAMAGES ARISING FROM ANY DEFECT OR ERROR IN THIS MANUAL OR PRODUCT.

SPECIFICATIONS AND INFORMATION CONTAINED IN THIS MANUAL ARE FURNISHED FOR INFORMATIONAL USE ONLY, AND ARE SUBJECT TO CHANGE AT ANY TIME WITHOUT NOTICE, AND SHOULD NOT BE CONSTRUED AS A COMMITMENT BY ASUS. ASUS ASSUMES NO RESPONSIBILITY OR LIABILITY FOR ANY ERRORS OR INACCURACIES THAT MAY APPEAR IN THIS MANUAL, INCLUDING THE PRODUCTS AND SOFTWARE DESCRIBED IN IT.

Products and corporate names appearing in this manual may or may not be registered trademarks or copyrights of their respective companies, and are used only for identification or explanation and to the owners' benefit, without intent to infringe.

# Contents

Contents .....	iii
Notices .....	iv
Safety information .....	v
Care & Cleaning .....	vi
Takeback Services .....	vii
<b>Chapter 1: Product introduction</b>	
1.1 Welcome! .....	1-1
1.2 Package contents .....	1-1
1.3 Monitor introduction .....	1-2
1.3.1 Front view .....	1-2
1.3.2 Back view .....	1-3
1.3.3 QuickFit Function .....	1-4
<b>Chapter 2: Setup</b>	
2.1 Detaching the arm/base (for VESA wall mount) .....	2-1
2.2 Adjusting the monitor .....	2-2
2.3 Connecting the cables .....	2-3
2.4 Turning on the monitor .....	2-4
<b>Chapter 3: General instructions</b>	
3.1 OSD (On-Screen Display) menu .....	3-1
3.1.1 How to reconfigure .....	3-1
3.1.2 OSD function introduction .....	3-1
3.2 Specifications summary .....	3-9
3.3 Troubleshooting (FAQ) .....	3-10
3.4 Supported operating modes .....	3-11

# Notices

## Federal Communications Commission Statement

This device complies with Part 15 of the FCC Rules. Operation is subject to the following two conditions:

- This device may not cause harmful interference, and
- This device must accept any interference received including interference that may cause undesired operation.

This equipment has been tested and found to comply with the limits for a Class B digital device, pursuant to Part 15 of the FCC Rules. These limits are designed to provide reasonable protection against harmful interference in a residential installation. This equipment generates, uses and can radiate radio frequency energy and, if not installed and used in accordance with manufacturer's instructions, may cause harmful interference to radio communications. However, there is no guarantee that interference will not occur in a particular installation. If this equipment does cause harmful interference to radio or television reception, which can be determined by turning the equipment off and on, the user is encouraged to try to correct the interference by one or more of the following measures:

- Reorient or relocate the receiving antenna.
- Increase the separation between the equipment and receiver.
- Connect the equipment to an outlet on a circuit different from that to which the receiver is connected.
- Consult the dealer or an experienced radio/TV technician for help.



---

The use of shielded cables for connection of the monitor to the graphics card is required to assure compliance with FCC regulations. Changes or modifications to this unit not expressly approved by the party responsible for compliance could void the user's authority to operate this equipment.

---



---

As an Energy Star® Partner, our company has determined that this product meets the Energy Star® guidelines for energy efficiency.

---

## Canadian Department of Communications Statement

This digital apparatus does not exceed the Class B limits for radio noise emissions from digital apparatus set out in the Radio Interference Regulations of the Canadian Department of Communications.

This class B digital apparatus complies with Canadian ICES-003.

This Class B digital apparatus meets all requirements of the Canadian Interference - Causing Equipment Regulations.

Cet appareil numérique de la classe B respecte toutes les exigences du Règlement sur le matériel brouiller du Canada.



## Safety information

- Before setting up the monitor, carefully read all the documentation that came with the package.
- To prevent fire or shock hazard, never expose the monitor to rain or moisture.
- Never try to open the monitor cabinet. The dangerous high voltages inside the monitor may result in serious physical injury.
- If the power supply is broken, do not try to fix it by yourself. Contact a qualified service technician or your retailer.
- Before using the product, make sure all cables are correctly connected and the power cables are not damaged. If you detect any damage, contact your dealer immediately.
- Slots and openings on the back or top of the cabinet are provided for ventilation. Do not block these slots. Never place this product near or over a radiator or heat source unless proper ventilation is provided.
- The monitor should be operated only from the type of power source indicated on the label. If you are not sure of the type of power supply to your home, consult your dealer or local power company.
- Use the appropriate power plug which complies with your local power standard.
- Do not overload power strips and extension cords. Overloading can result in fire or electric shock.
- Avoid dust, humidity, and temperature extremes. Do not place the monitor in any area where it may become wet. Place the monitor on a stable surface.
- Unplug the unit during a lightning storm or if it will not be used for a long period of time. This will protect the monitor from damage due to power surges.
- Never push objects or spill liquid of any kind into the slots on the monitor cabinet.
- To ensure satisfactory operation, use the monitor only with UL listed computers which have appropriate configured receptacles marked between 100-240V AC.
- If you encounter technical problems with the monitor, contact a qualified service technician or your retailer.
- Adjustment of the volume control as well as the equalizer to other settings than the center position may increase the ear-/headphones output voltage and therefore the sound pressure level.



This symbol of the crossed out wheeled bin indicates that the product (electrical, electronic equipment, and mercury-containing button cell battery) should not be placed in municipal waste. Please check local regulations for disposal of electronic products.

**AEEE yönetmeliğine uygundur**

## Care & Cleaning

- Before you lift or reposition your monitor, it is better to disconnect the cables and power cord. Follow the correct lifting techniques when positioning the monitor. When lifting or carrying the monitor, grasp the edges of the monitor. Do not lift the display by the stand or the cord.
- Cleaning. Turn your monitor off and unplug the power cord. Clean the monitor surface with a lint-free, non-abrasive cloth. Stubborn stains may be removed with a cloth dampened with mild cleaner.
- Avoid using a cleaner containing alcohol or acetone. Use a cleaner intended for use with the monitor. Never spray cleaner directly on the screen, as it may drip inside the monitor and cause an electric shock.

### The following symptoms are normal with the monitor:

- You may find slightly uneven brightness on the screen depending on the desktop pattern you use.
- When the same image is displayed for hours, an afterimage of the previous screen may remain after switching the image. The screen will recover slowly or you can turn off the Power Switch for hours.
- When the screen becomes black or flashes, or cannot work anymore, contact your dealer or service center to fix it. Do not repair the screen by yourself!

### Conventions used in this guide



**WARNING:** Information to prevent injury to yourself when trying to complete a task.



**CAUTION:** Information to prevent damage to the components when trying to complete a task.



**IMPORTANT:** Information that you **MUST** follow to complete a task.



**NOTE:** Tips and additional information to aid in completing a task.

## Where to find more information

Refer to the following sources for additional information and for product and software updates.

### 1. **ASUS websites**

The ASUS websites worldwide provide updated information on ASUS hardware and software products. Refer to <http://www.asus.com>

### 2. **Optional documentation**

Your product package may include optional documentation that may have been added by your dealer. These documents are not part of the standard package.

## Takeback Services

ASUS recycling and takeback programs come from our commitment to the highest standards for protecting our environment. We believe in providing solutions for our customers to be able to responsibly recycle our products, batteries and other components as well as the packaging materials.

Please go to <http://csr.asus.com/english/Takeback.htm> for detail recycling information in different region.

## Congratulations!

### This product is TCO Certified – for Sustainable IT



TCO Certified is an international third party sustainability certification for IT products. TCO Certified ensures that the manufacture, use and recycling of IT products reflect environmental, social and economic responsibility. Every TCO Certified product model is verified by an accredited independent test laboratory.

This product has been verified to meet all the criteria in TCO Certified, including:

#### **Corporate Social Responsibility**

Socially responsible production - working conditions and labor law in manufacturing country

#### **Energy Efficiency**

Energy efficiency of product and power supply. Energy Star compliant, where applicable

#### **Environmental Management System**

Manufacturer must be certified according to either ISO 14001 or EMAS

#### **Minimization of Hazardous Substances**

Limits on cadmium, mercury, lead & hexavalent chromium including requirements for mercury-free products, halogenated substances and hazardous flame retardants

#### **Design for Recycling**

Coding of plastics for easy recycling. Limit on the number of different plastics used.

#### **Product Lifetime, Product Take Back**

Minimum one-year product warranty. Minimum three-year availability of spare parts. Product takeback

#### **Packaging**

Limits on hazardous substances in product packaging. Packaging prepared for recycling

#### **Ergonomic, User-centered design**

Visual ergonomics in products with a display. Adjustability for user comfort (displays, headsets)

Acoustic performance – protection against sound spikes (headsets) and fan noise (projectors, computers)

Ergonomically designed keyboard (notebooks)

#### **Electrical Safety, minimal electro-magnetic Emissions**

#### **Third Party Testing**

All certified product models have been tested in an independent, accredited laboratory.

A detailed criteria set is available for download at [www.tcodevelopment.com](http://www.tcodevelopment.com), where you can also find a searchable database of all TCO Certified IT products.

TCO Development, the organization behind TCO Certified, has been an international driver in the field of Sustainable IT for 20 years. Criteria in TCO Certified are developed in collaboration with scientists, experts, users and manufacturers. Organizations around the world rely on TCO Certified as a tool to help them reach their sustainable IT goals. We are owned by TCO, a non-profit organization representing office workers. TCO Development is headquartered in Stockholm, Sweden, with regional presence in North America and Asia.

For more information, please visit  
[www.tcodevelopment.com](http://www.tcodevelopment.com)



## 1.1 Welcome!

Thank you for purchasing the ASUS® LCD monitor!

The latest widescreen LCD monitor from ASUS provides a broader, brighter and crystal-clear display, plus a host of features that enhance your viewing experience.

With these features, you can enjoy the convenience and delightful visual experience that the monitor brings to you!

## 1.2 Package contents

Check your package for the following items:

- ✓ LCD monitor
- ✓ Quick start guide
- ✓ Warranty card
- ✓ Power cord
- ✓ HDMI cable
- ✓ DisplayPort cable (Mini-DP to DP)
- ✓ USB 3.0 cable
- ✓ Support CD
- ✓ Cable tie
- ✓ Color Calibration Testing Report



---



If any of the above items is damaged or missing, contact your retailer immediately.

---

# 1.3 Monitor introduction

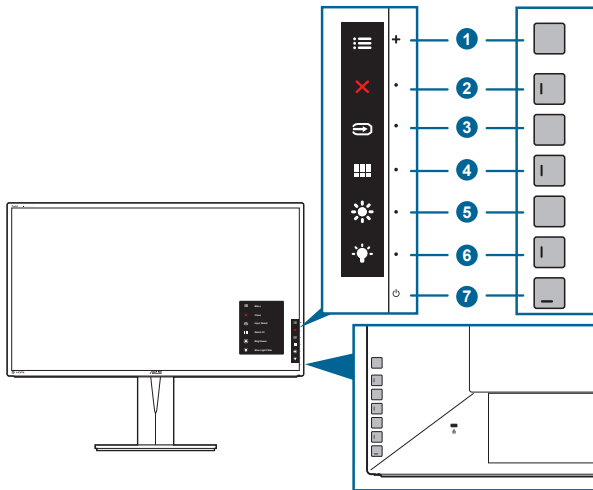
## 1.3.1 Front view





1.  Menu (5-way) button:
  - Press this button to enter the OSD menu.
  - Enacts the selected OSD menu items.
  - Increases/Decreases values or moves your selection up/down/left/right.
2.  Close button:
  - Exits the OSD menu.
  - Toggles the Key Lock function between on and off with a long press for 5 seconds.
3.  Input select button:
  - Selects an available input source.



---

Press  button (Input Select button) to display HDMI-1, HDMI-2, HDMI-3, HDMI-4, DisplayPort, mini DisplayPort signals after you connect HDMI/DisplayPort/Mini DisplayPort cable with the monitor.

---

4.  QuickFit button:
  - This is a hotkey to activate the QuickFit function designed for alignment.
  - The QuickFit function contains 5 types of alignment patterns. (Please refer to 1.3.3 QuickFit Function).
5.  Shortcut 1
  - Default: Brightness hotkey
  - To change the hotkey function, go to the Shortcut > Shortcut 1 menu.

## 6. Shortcut 2

- Default: Blue Light Filter hotkey
- To change the hotkey function, go to the Shortcut > Shortcut 2 menu.

## 7. Power button/power indicator

- Turns the monitor on/off.
- The color definition of the power indicator is as the below table.

Status	Description
White	On
Amber	Standby mode
Off	Off

### 1.3.2 Back/Side view

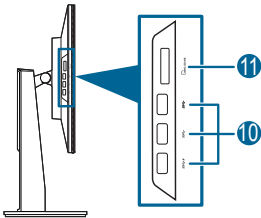
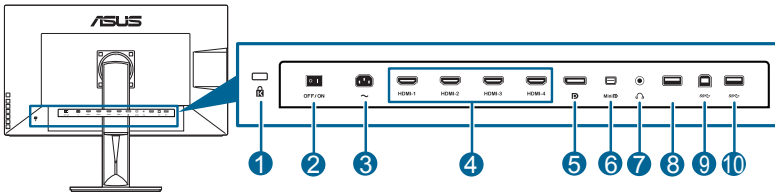

1. **Kensington lock slot.**
2. **Power switch.** Press the switch to turn on/off power.
3. **AC-IN port.** This port connects the power cord.
4. **HDMI port.** This port is for connection with an HDMI compatible device.



HDMI-1 port specially supports few uncertain HDMI1.4 EDID devices. Press “Input Select” key for 5 seconds for optimal EDID.

5. **DisplayPort in.** This port is for connection with a DisplayPort compatible device.



The default setting of DisplayPort Stream in the OSD menu is DisplayPort 1.2. You can change it to DisplayPort 1.1 when your device output signal is DisplayPort 1.1 .

6. **Mini DisplayPort in.** This port is for connection with a Mini DisplayPort compatible device.
7. **Earphone jack.**
8. **USB 2.0 A-type.** This port is for service only.
9. **USB 3.0 upstream port.** This port is for connection with a USB upstream cable. The connection enables the USB ports on the monitor.
10. **USB 3.0 downstream ports.** These ports are for connection with USB devices, such as USB keyboard/mouse, USB flash drive, etc.



---

This monitor is Super-Speed USB 3.0 compatible. Port with  icon is BC1.2 compliant.

---

11. **Card reader.** See below for more information about the card reader specifications.

### Card reader specifications

- Support Secure Digital™ v1.0 / v1.1 / v2.0/ SDHC / SDXC (Capacity up to 2TB)
- Support Secure Digital™ v3.0 UHS-I (Ultra High Speed): SDR12/SDR25/SDR50/DDR50/SDR104
- Compliant with MultiMediaCard™ (MMC)
  - MMC specification v3.x / v4.0 / v4.1 / v4.2 / v4.3 / v4.4
  - x1 / x4
- Support Memory Stick PRO / Memory Stick PRO Duo / Memory Stick Micro / Memory
  - Stick PRO-HG / Memory Stick XC (Capacity up to 32GB)
  - Compliant with Memory Stick Series Specification: MS v1.43, MS PRO v1.05, MS Micro v1.04 (MS HG Micro v1.00), MS PRO-HG Duo 1.03, MS XC Duo v1.00, MS XC-HG Duo v1.00, MS XC Micro v1.00 and MS XC-HG Micro v1.00
  - Support Read/Write quad data access (512Byte×4) for MS PRO-HG to enhance the transmission rate

### 1.3.3 QuickFit Function

The QuickFit function contains 5 types of patterns: (1) Alignment Grid (2) A4 (3) B5 (4) Customization (5) Ruler. To activate the patterns, press the QuickFit button. Use the  Menu (5-way) button to select a desired pattern. You can move the button up/down/left/right to change the pattern's position if needed. Note that all the patterns can be moved left/right according to your need, but may have limited range for moving up/down.

#### 1. Alignment Grid

The grid patterns facilitate designers and users to organize content and layout on a page and achieve a consistent look and feel.

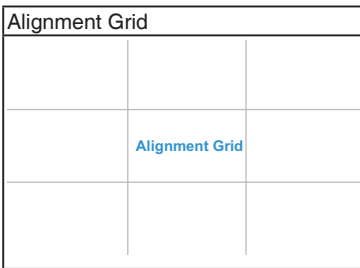

#### 2. A4

QuickFit provides standard A4 paper size for users to view their documents in real size on the screen.

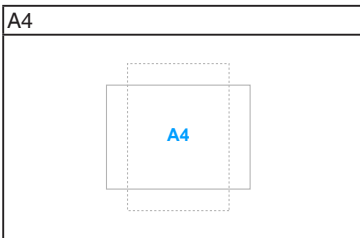

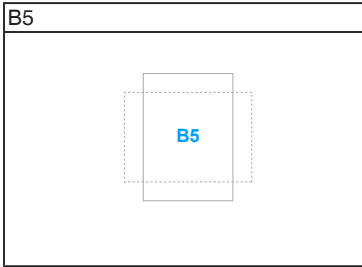

#### 3. B5

QuickFit provides standard B5 paper size for users to view their documents in real size on the screen.



#### 4. Customization

You can decide the frame size by moving the  Menu (5-way) button up/down/left/right. You can press the  Menu (5-way) button for longer than 3 seconds to switch the measurements between millimeter and inch.

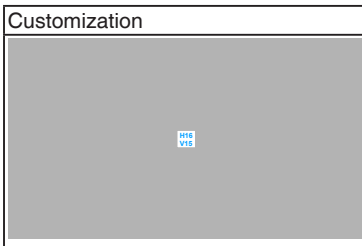

#### 5. Ruler

This pattern presents physical ruler on top and left side. You can press the  Menu (5-way) button for longer than 3 seconds to switch the measurements between metric and imperial.

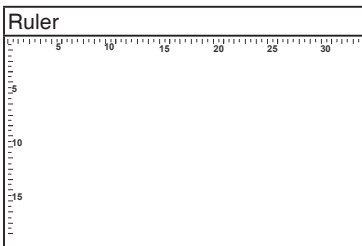

## 2.1 Detaching the arm/base (for VESA wall mount)

The detachable arm/base of this monitor is specially designed for VESA wall mount.

To detach the arm/base:

1. Have the front of the monitor face down on a table.
2. Press the release button, and then detach the arm/base from the monitor (Figure 2).

(Figure 1)

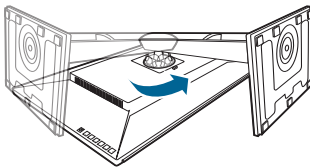

(Figure 2)

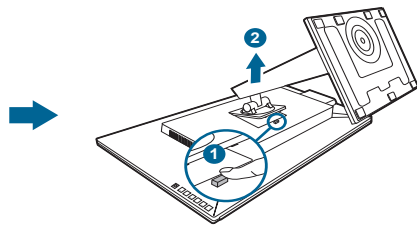

---

We recommend that you cover the table surface with soft cloth to prevent damage to the monitor.

---



- The VESA wall mount kit (100 x 100 mm) is purchased separately.
  - Use only the UL Listed Wall Mount Bracket with minimum weight/load 22.7kg (Screw size: M4 x 10 mm)
-

## 2.2 Adjusting the monitor

- For optimal viewing, we recommend that you look at the full face of the monitor, then adjust the monitor to the angle that is most comfortable for you.
- Hold the stand to prevent the monitor from falling when you change its angle.
- You can adjust the monitor's angle from  $+20^\circ$  to  $-5^\circ$ , and it allows  $60^\circ$  swivel adjustment from either left or right. You can also adjust the monitor's height within  $\pm 130$  mm.

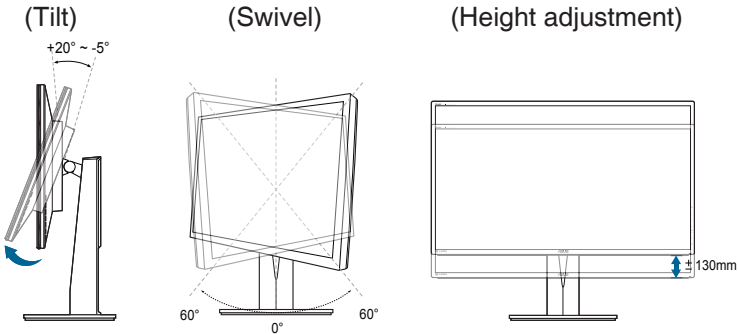

### Pivoting the monitor

1. Lift the monitor to the highest position.
2. Tilt the monitor to its maximum angle.
3. Pivot the monitor clockwise to the angle you need.

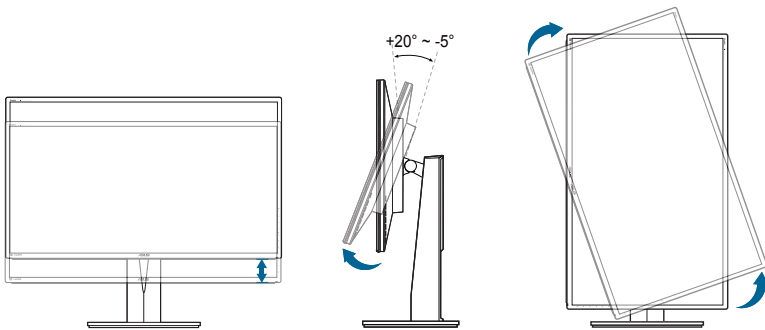

It is normal that the monitor slightly shakes while you adjust the viewing angle.



- The OSD menu item will automatically rotate when the monitor rotates.

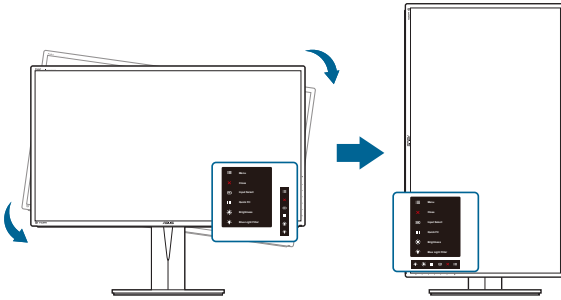

## 2.3 Connecting the cables

Connect the cables as the following instructions:

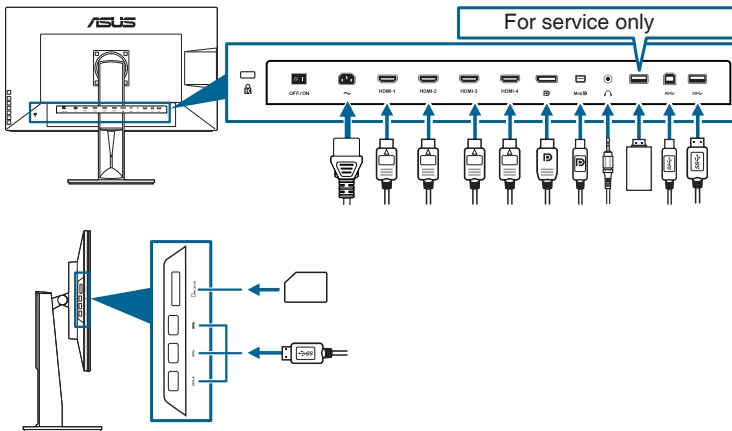

- To connect the power cord:** Connect one end of the power cord securely to the monitor's AC input port, the other end to a power outlet.
- To connect the HDMI/DisplayPort/Mini DisplayPort cable:**
  - Plug one end of the HDMI/DisplayPort/Mini DisplayPort cable to the monitor's HDMI/DisplayPort/Mini DisplayPort jack.
  - Connect the other end of the HDMI/DisplayPort/Mini DisplayPort cable to your computer's HDMI/DisplayPort/Mini DisplayPort jack.
- To use the earphone:** connect the end with plug type to the monitor's earphone jack when an HDMI or DisplayPort signal is fed.

- **To use the USB 3.0 ports:** Take the supplied USB 3.0 cable, and plug the smaller end (type B) of the USB upstream cable to the monitor's USB upstream port, and the larger end (type A) to your computer's USB 3.0 port. Make sure your computer is installed with the latest Windows 7/Windows 8 operating system. That will enable the USB ports on the monitor to work.





---

When these cables are connected, you can choose the desired signal from the Input Select item in the OSD menu.

---







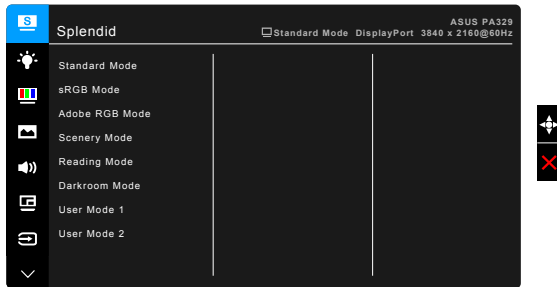

## 2.4 Turning on the monitor

Press the power button . See page 1-2 for the location of the power button. The power indicator  lights up in white to show that the monitor is ON.

## 3.1 OSD (On-Screen Display) menu

### 3.1.1 How to reconfigure



1. Press the  Menu (5-way) button to activate the OSD menu.
2. Move the  Menu (5-way) button up/down/left/right to navigate through the functions. Highlight the desired function and press the  Menu (5-way) button to activate it. If the function selected has a sub-menu, move the  Menu (5-way) button up/down to navigate through the sub-menu functions. Highlight the desired sub-menu function and press the  Menu (5-way) button or move the  Menu (5-way) button to activate it.
3. Move the  Menu (5-way) button up/down to change the settings of the selected function.
4. To exit and save the OSD menu, press the  button or move the  Menu (5-way) left repeatedly until the OSD menu disappears. To adjust other functions, repeat steps 1-3.

### 3.1.2 OSD function introduction

#### 1. Splendid

This function contains 8 sub-functions you can select for your preference. Each mode has the Reset selection, allowing you to maintain your setting or return to the preset mode.

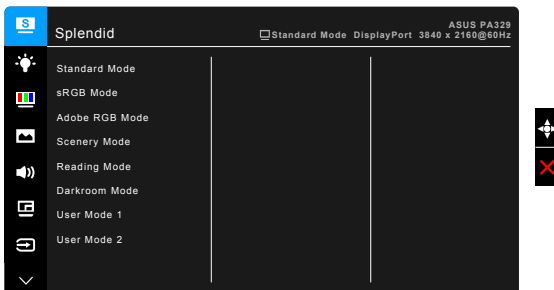

- **Standard Mode:** Best choice for document editing with SplendidPlus Video Enhancement.
- **sRGB Mode:** Compatible with sRGB color space, sRGB mode is the best choice for document editing.
- **Adobe RGB Mode:** compatible with Adobe RGB color space.
- **Scenery Mode:** Best choice for scenery photo display with SplendidPlus Video Enhancement.
- **Reading Mode:** This is the best choice for book reading.
- **Darkroom Mode:** This is the best choice for a weak ambient light environment.
- **User Mode 1/User Mode 2:** Allows you to make color adjustments in the Advanced Setting. You can also save one or two ProArt Calibration profiles as User Mode 1/User Mode 2 after executing ProArt Calibration and then have quick access here.

Function	Standard Mode	sRGB Mode	AdobeRGB Mode	Scenery Mode	Reading Mode	Darkroom Mode	User Mode 1/User Mode 2
Color Temp.	6500K	Disable	Disable	6500K	Disable	6500K	Disable
Brightness	50	Disable	Disable	100	Enable	Enable	50
Contrast	80	Disable	Disable	80	Disable	80	80
ASCR	Disable	Disable	Disable	Off	Disable	Off	Off
Sharpness	Disable	Disable	Disable	High (60)	Middle (50)	High (60)	Middle (50)
Saturation	Disable	Disable	Disable	Middle (50)	Disable	Middle (50)	Middle (50)
Hue	Disable	Disable	Disable	Middle (50)	Disable	Middle (50)	Middle (50)
Advanced Setting	Disable	Disable	Disable	Enable	Disable	Enable	Disable
Gamma	Enable	Disable	Disable	Disable	Enable	Enable	Disable
Uniformity Compensation	Enable	Disable	Disable	Disable	Disable	Disable	Disable

## 2. Blue Light Filter

In this function, you can adjust the blue light filter level.

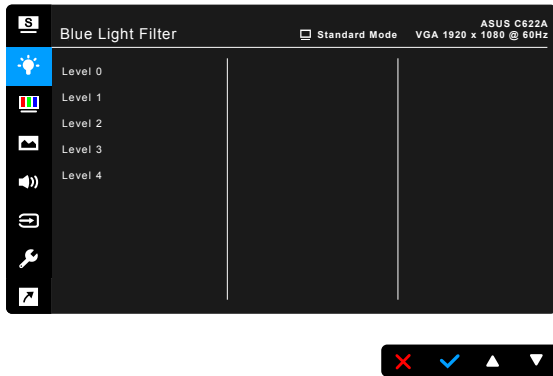

- **Level 0:** No change.
- **Level 1~4:** The higher the level, the less blue light is scattered. When Blue Light Filter is activated, the default settings of Standard Mode will be automatically imported. Between Level 1 to Level 3, the Brightness function is user-configurable. Level 4 is optimized setting. It is compliance with TUV Low Blue Light Certification. The Brightness function is not user-configurable.

## 3. Color

Set a desired color setting from this menu.

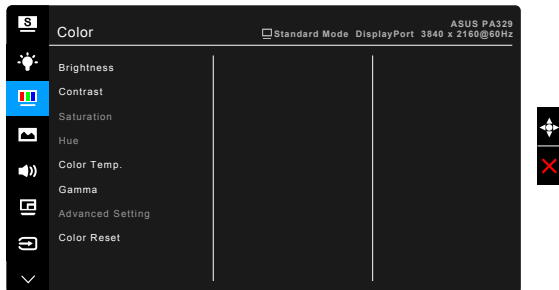

- **Brightness:** The adjusting range is from 0 to 100.
- **Contrast:** The adjusting range is from 0 to 100.
- **Saturation:** The adjusting range is from 0 to 100.
- **Hue:** Shifts the image color between green and purple.
- **Color Temp.:** Contains 4 modes including 9300K, 6500K, 5500K and 5000K.

- **Gamma:** Allows you to set the color mode to 2.4, 2.2, 2.0 or 1.8.
- **Advanced Setting:**
  - \* Six-axis Hue adjustment.
  - \* Six-axis Saturation adjustment.
  - \* Adjusts the gain levels for R, G, B.
  - \* Adjusts the black level offset values for R, G, B.
- **Color Reset:**
  - \* Current Splendid color mode reset:  
Resets the color settings of current color mode to the factory default value.
  - \* All Splendid color mode reset:  
Resets the color settings of all color modes to the factory default value.

#### 4. Image

Set the image related setting from this menu.

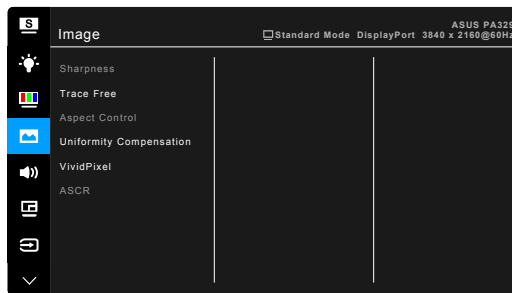

- **Sharpness:** The adjusting range is from 0 to 100.
- **Trace Free:** Adjusts the response time of the monitor.
- **Aspect Control:** Adjusts the aspect ratio to full, 4:3, 1:1 or OverScan.



---

4:3 is only available when input source is in 4:3 format. OverScan is only available for the HDMI input source.

---

- **Uniformity Compensation:** Adjusts different areas of the screen to reduce any screen uniformity errors, providing consistent brightness and color across the entire screen.
- **VividPixel:** Enhances the outline of the displayed picture and generates high-quality images on screen.
- **ASCR:** Turns on/off the ASCR (ASUS Smart Contrast Ratio) function.

## 5. Sound

You can adjust Volume, Mute and Source from this menu.

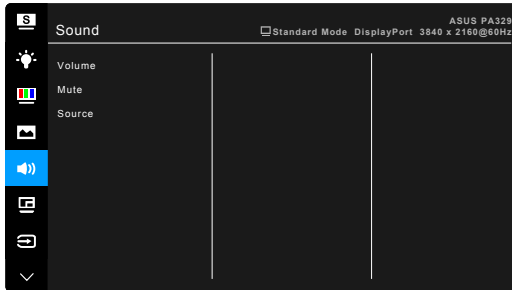

- **Volume:** the adjusting range is from 0 to 100.
- **Mute:** toggles the monitor sound between on and off.
- **Source:** decides the monitor sound comes from which source.

## 6. PIP/PBP Setting

The PIP/PBP Setting allows you to open up another sub-window connected from another video source besides the main-window from your original video source. By activating this function, the monitor displays up to 4 pictures from different video sources.

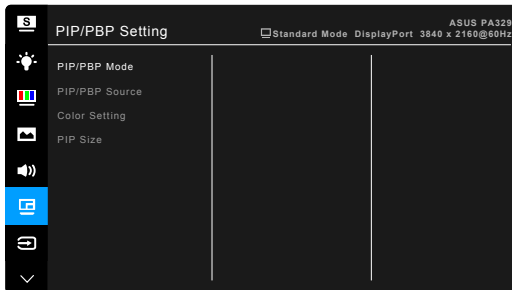

- **PIP/PBP Mode:** Selects PIP, PBP, PBP x 3 or PBP x 4 function, or turn it off.
- **PIP/PBP Source:** Selects the video input source from among HDMI-1, HDMI-2, HDMI-3, HDMI-4, DisplayPort, and Mini DisplayPort.



PIP/PBP mode supports up to 2 HDMI inputs simultaneously. While there are 2 HDMI input sources selected, the maximum resolution of each HDMI source will be 4K@30Hz.

- **Color Setting:** Selects an individual Splendid Mode for the selected PIP/ PBP source.
- **PIP Size:** Adjusts the PIP size to Small, Middle, or Large. (Only available for the PIP mode)

		Main-window					
Sub-window		HDMI-1	HDMI-2	HDMI-3	HDMI-4	DisplayPort	Mini DisplayPort
	HDMI-1	Yes	Yes	Yes	Yes	Yes	Yes
	HDMI-2	Yes	Yes	Yes	Yes	Yes	Yes
	HDMI-3	Yes	Yes	Yes	Yes	Yes	Yes
	HDMI-4	Yes	Yes	Yes	Yes	Yes	Yes
	DisplayPort	Yes	Yes	Yes	Yes	Yes	Yes
	Mini DisplayPort	Yes	Yes	Yes	Yes	Yes	Yes

## 7. Input Select

In this function, you can select your desired input source.

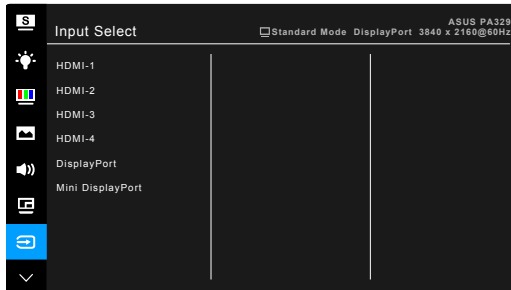

## 8. System Setup

Allows you to adjust the system.

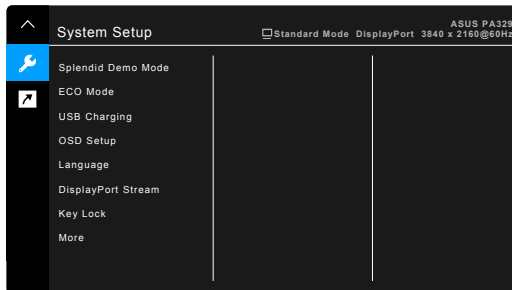



- **Splendid Demo Mode:** Splits the screen into two for Splendid modes comparison. (Scenery mode only)
- **ECO Mode:** reduces power consumption.
- **USB Charging:**
  - \* “On During Standby” allows the USB downstream ports to charge external devices when the monitor is turned on or in standby mode.
  - \* “Off During Standby” allows the USB downstream ports to charge external devices only when the monitor is turned on.
- **OSD Setup:**
  - \* Adjusts the OSD timeout from 10 to 120 seconds.
  - \* Enables or disables the DDC/CI function.
  - \* Adjusts the OSD background from opaque to transparent.
  - \* Adjusts the OSD rotation.
- **Language:** There are 21 languages for your selection, including English, French, German, Italian, Spanish, Dutch, Portuguese, Russian, Czech, Croatian, Polish, Romanian, Hungarian, Turkish, Simplified Chinese, Traditional Chinese, Japanese, Korean, Thai, Indonesia, Persian.
- **DisplayPort Stream:** Compatibility with graphic card. Select DisplayPort 1.1 or DisplayPort 1.2 by graphic card DP version. (3840x2160-60Hz is available at DP 1.2 only. The best resolution is 3840x2160-30Hz at DP 1.1). Follow the instructions below to change 4K2K, 30Hz to 4K2K, 60Hz on your PC: In Windows, right click the desktop and enter the Screen Resolution. Go to Advanced Settings, and set the refresh rate to 60Hz from 30Hz.
- **Keylock:** To disable all function keys. Press the second button from the top over five seconds to cancel the key lock function.
- **Power Indicator:** Turns the power LED indicator on/off.
- **Information:** Shows the monitor information.
- **All Reset:** “Yes” allows you to restore the default settings.

## 9. Shortcut

Defines the functions for Shortcut 1 and 2 buttons.



- **Shortcut 1/Shortcut 2:** selects a function for Shortcut 1 and 2 buttons.



---

When a certain function is selected or activated, your shortcut key may not support. Available function choices for shortcut: Brightness, Contrast, PIP/PBP Setting, Color Temp., Volume, User Mode 1, User Mode 2.

---

## 3.2 Specifications summary

<b>Panel Type</b>	TFT LCD
<b>Panel size</b>	32.0" (16:9, 81.3 cm) wide screen
<b>Max. Resolution</b>	3840 x 2160
<b>Pixel pitch</b>	0.185 mm
<b>Brightness (Typ.)</b>	300 cd/m <sup>2</sup>
<b>Contrast Ratio (Typ.)</b>	1000:1
<b>Contrast Ratio (Max.)</b>	100,000,000:1 (with ASCR on)
<b>Viewing angle (H/V) CR&gt;10</b>	178°/178°
<b>Display colors</b>	1.07 B
<b>Color gamut</b>	Adobe RGB 99.5%, sRGB 100%
<b>Response time</b>	5 ms (Gray to gray)
<b>SplendidPlus Video Enhancement</b>	Yes
<b>SplendidPlus selection</b>	8 video preset modes
<b>Color temperature selection</b>	4 color temperatures
<b>Digital input</b>	HDMI v2.0, DisplayPort v1.2
<b>Earphone jack</b>	Yes
<b>USB 3.0 port</b>	Upstream x 1, Downstream x 5
<b>Card reader</b>	9 in 1
<b>Colors</b>	Black
<b>Power LED</b>	White (On)/Amber (Standby)
<b>Tilt</b>	+20° ~ -5°
<b>Swivel</b>	+60° ~ -60°
<b>Height Adjustment</b>	130 mm
<b>Kensington lock</b>	Yes
<b>AC input voltage</b>	AC: 100~240V
<b>Power consumption</b>	Power On: < 138.3 W*** (Typ.), Standby: < 1.4 W (Typ.), Power Off: 0 W (Switch off)
<b>Temperature (Operating)</b>	0°C~40°C
<b>Temperature (Non-operating)</b>	-20°C~+60°C
<b>Dimension (W x H x D)</b>	735 mm x 615 mm x 240 mm (highest) 735 mm x 485 mm x 240 mm (lowest) 847 mm x 552 mm x 350 mm (package)
<b>Weight (Esti.)</b>	12.5 kg (Net); 16.7 kg (Gross)
<b>Multi-languages</b>	21 languages (English, French, German, Italian, Spanish, Dutch, Portuguese, Russian, Czech, Croatian, Polish, Romanian, Hungarian, Turkish, Simplified Chinese, Traditional Chinese, Japanese, Korean, Thai, Indonesia, Persian)
<b>Accessories</b>	HDMI cable, DisplayPort cable (Mini-DP to DP), Power cord, USB cable, Quick start guide, Warranty card, Support CD, Cable tie, Color Calibration Testing Report
<b>Regulation approvals</b>	Energy Star, China Energy Level 1, UL/cUL, CB, CE, EuP, FCC (Class B), CCC, BSMI, CU, C-Tick, VCCI, TCO 7.0, TUV-GS, TUV-Ergo, Ukraine, J-MOSS, RoHS, WEEE, PSE, PSB, KCC, eStandby, Windows 7, 8.1 and 10 WHQL, Mac Compliance**

\*Specifications are subject to change without notice.

\*\*Requires Mac OS 10.10.x, 10.9.x, 10.8.x.

\*\*\*measuring a screen brightness of 200 nits without audio/USB/Card reader connection.

### 3.3 Troubleshooting (FAQ)

Problem	Possible Solution
Power LED is not ON	<ul style="list-style-type: none"><li>• Press the  button to check if the monitor is in the ON mode.</li><li>• Check if the power cord is properly connected to the monitor and the power outlet.</li><li>• Check if the power switch is ON.</li></ul>
The power LED lights amber and there is no screen image	<ul style="list-style-type: none"><li>• Check if the monitor and the computer are in the ON mode.</li><li>• Make sure the signal cable is properly connected to the monitor and the computer.</li><li>• Inspect the signal cable and make sure none of the pins are bent.</li><li>• Connect the computer with another available monitor to check if the computer is properly working.</li></ul>
Screen image is too light or dark	<ul style="list-style-type: none"><li>• Adjust the Contrast and Brightness settings via OSD.</li></ul>
Screen image is not centered or sized properly	<ul style="list-style-type: none"><li>• Adjust the H-Position or V-Position settings via OSD.</li></ul>
Screen image bounces or a wave pattern is present in the image	<ul style="list-style-type: none"><li>• Make sure the signal cable is properly connected to the monitor and the computer.</li><li>• Move electrical devices that may cause electrical interference.</li></ul>
Screen image has color defects (white does not look white)	<ul style="list-style-type: none"><li>• Inspect the signal cable and make sure that none of the pins are bent.</li><li>• Perform All Reset via OSD.</li><li>• Adjust the R/G/B color settings or select the Color Temperature via OSD.</li></ul>
Screen image is blurry or fuzzy	<ul style="list-style-type: none"><li>• Adjust the Phase and Clock settings via OSD.</li></ul>
No sound or sound is low	<ul style="list-style-type: none"><li>• Ensure that the HDMI/DisplayPort cable is properly connected to the monitor and the computer.</li><li>• Adjust the volume settings of both your monitor and HDMI/DisplayPort device.</li><li>• Ensure that the computer sound card driver is properly installed and activated.</li></ul>

## 3.4 Supported operating modes

Resolution Frequency	Horizontal Frequency (KHz)	Vertical Frequency (Hz)	Pixel (MHz)
640x350	70(N)	31.47(P)	25.18
640x480	59.94(N)	31.47(N)	25.18
640x480	72.82(N)	37.87(N)	31.5
640x480	75.00(N)	37.5(N)	31.5
720x400	70.08(P)	31.47(N)	28.32
800x600	56.25(P)	35.16(P)	36.00
800x600	60.32(P)	37.88(P)	40.00
800x600	72.12(P)	48.08(P)	50.00
800x600	75.00(P)	46.86(P)	49.50
848x480	60(P)	31.0(P)	33.75
1024x768	60.00(N)	48.36(N)	65.00
1024x768	70.069(N)	56.476(N)	75.00
1024x768	75.00(N)	60.02(N)	78.75
1152x864	75.00(P/N)	67.5(P/N)	108.00
1280x720	60	44.77(N)	74.5
1280x768	60(N)	47.8(N)	79.5
1280x768	75(P)	60.3(P)	102.25
1280x800	60(P)	49.7(N)	84.5
1280x960	60.00(N)	60.00(P)	108.00
1280x1024	60.02(P)	63.98(P)	108.00
1280x1024	75.02(P)	79.98(P)	135.00
1366x768	59.79(P)	47.712(P)	85.50
1400x1050	60(P)	65.3(N)	121.75
1440x900	59.89(P)	55.94(N)	106.50
1600x1200	60.00(P)	75.00(P)	162.00
1680x1050	60.00(P)	65.29(N)	146.25
1920x1080	60.00(P)	67.5(P)	148.5
1920x1200 (Reduced Blanking)	59.95(N)	74.038(P)	154
1920x1200	59.885(P)	74.556(N)	193.25
2560x1080	59.978(N)	66.636(P)	181.25
2560x1440	59.951(N)	88.787(P)	241.50
3840x2160	24(P)	52.593(N)	266.75
3840x2160	25	54.786(N)	278.75
3840x2160	30(P)	65.956(N)	338.75
3840x2160	50(P)	111.174(N)	587
3840x2160 (Reduced Blanking)	60(N)	133.313(P)	533.25

When the monitor is operating in the video mode (ie, not displaying data) using the HDMI connector, the following high definition modes shall be supported in addition to standard definition video.

Resolution	Vertical Frequency (Hz)	Horizontal Frequency (KHz)
1920 × 1080p	24	27
	50	56.25
	59.94	67.43
	60	67.5
1920 × 1080i	50	28.13
	59.94	33.72
	60	33.75
1440x480P	59.94	31.47
	60	31.5
1440x576P	50	31.25
1280 × 720p	50	37.5
	59.94	44.95
	60	45
720 × 576p	50	31.25
720 × 480p	59.94	31.47
	60	31.5
640 × 480p(VGA)	59.94	31.47
	60	31.5
720(1440) × 576i	50	15.63
720(1440) × 480i	59.94	15.73
	60	15.75

**\* Modes not listed in the table may not be supported. For optimal resolution, we recommend that you choose a mode listed in the table above.**

# DECLARATION OF CONFORMITY

Per FCC Part 2 Section 2. 1077(a)



**Responsible Party Name:** **Asus Computer International**

**Address:** **800 Corporate Way, Fremont, CA 94539.**

**Phone/Fax No:** **(510)739-3777/(510)608-4555**

hereby declares that the product

**Product Name : LCD Monitor**

**Model Number : PA329\*\*\*\*\***

Conforms to the following specifications:

FCC Part 15, Subpart B, Unintentional Radiators

## **Supplementary Information:**

This device complies with part 15 of the FCC Rules. Operation is subject to the following two conditions: (1) This device may not cause harmful interference, and (2) this device must accept any interference received, including interference that may cause undesired operation.

Representative Person's Name : Steve Chang / President

A handwritten signature in blue ink that reads "Steve Chang". The signature is written in a cursive style and is placed over a light blue rectangular background.

Signature :

Date : Mar. 03, 2016