

GRAPHIC DEVELOPMENT MMD	
Product name	278C6QJ5W-Q5G
Project no.	
Finishing	Folded sheet
Scale	1:1
Size Spreads	594 (W) x 210 (H) mm
Size	148.5 (W) x 210 (H) mm
Operator(s)	
Date amended	Feb. 01, 2016
VERSION No.	13
APPROVAL	
QC Lithographer	
Product Manager	
Date Check	
ARTWORK DOCUMENT	
Paper	80gsm White, woodfree coated
Numbers of colours	2C+2C
Spotcolor	
Aftertreatment	
<input type="checkbox"/> Cropping	
<input type="checkbox"/> Coating	
<input type="checkbox"/> Varnishing	
<input type="checkbox"/> Embossing	
<input type="checkbox"/> Cutterguide	
<input type="checkbox"/> Die-cut	
<input type="checkbox"/> Binding	
<input type="checkbox"/> Glue	

5

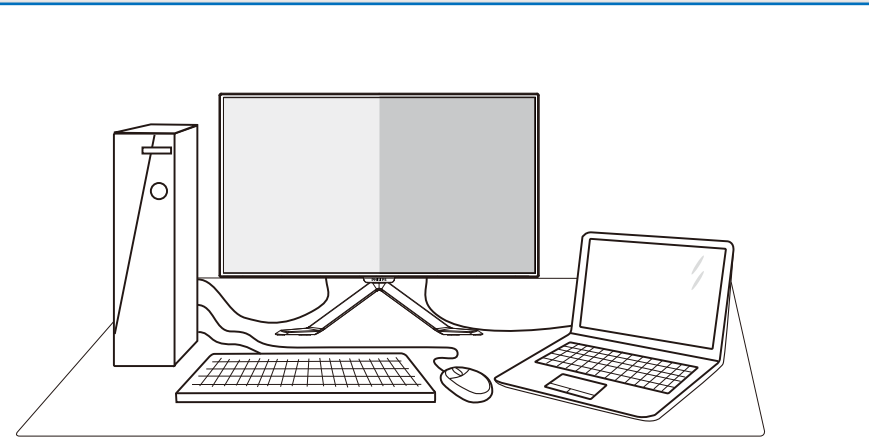

PIP

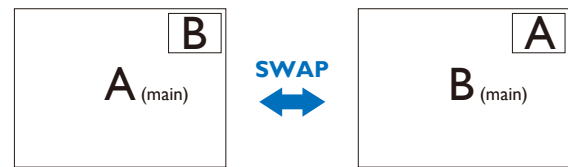

PBP

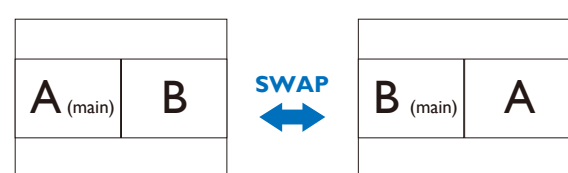

- ⑩ Need help?
Online help: www.philips.com/support
- ⑩ 需要帮助?
在线帮助: www.philips.com/support
- ⑩ Besoin d'Aide ?
Aide en ligne: www.philips.com/support
- ⑩ 도움이 필요하십니까?
온라인 도움말: www.philips.com/support
- ⑩ ¿Necesita ayuda?
Ayuda en línea: www.philips.com/support
- ⑩ ヘルプが必要ですか?
オンラインヘルプ: www.philips.com/support
- ⑩ Benötigen Sie Hilfe?
Online-Hilfe: www.philips.com/support
- ⑩ Yardım mı ihtiyacınız var?
Online yardım: www.philips.com/support
- ⑩ Avete bisogno di aiuto?
Guida in linea: www.philips.com/support
- ⑩ Precisa de ajuda?
Ajuda online: www.philips.com/support
- ⑩ Потребуєте допомоги?
Підтримка он-лайн: www.philips.com/support
- ⑩ मदद चाहिए?
ऑनलाइन मदद: www.philips.com/support
- ⑩ Нужна помощь?
Интерактивная справка: www.philips.com/support
- ⑩ هل تريد المساعدة؟
للمساعدة عبر الإنترنت: www.philips.com/support

Version: M6278CQ1T
© 2016 Koninklijke Philips N.V. All rights reserved.
Specifications are subject to change without notice.
Philips and the Philips Shield Emblem are registered trademarks of Koninklijke Philips N.V. and are used under license from Koninklijke Philips N.V.



Register your product and get support at
www.philips.com/welcome

Brilliance
278C6

Quick Start



PHILIPS

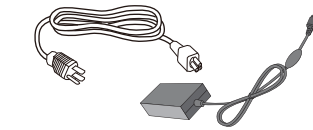
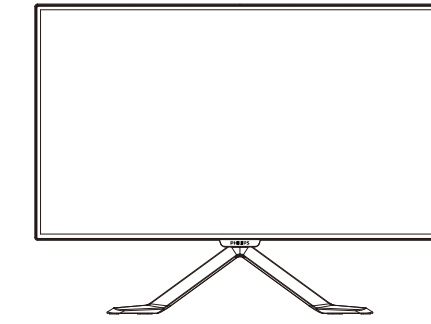

AC/DC Adapter



* CD

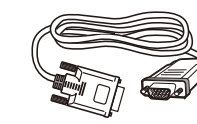

* VGA

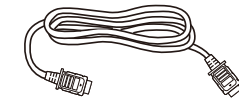

* HDMI

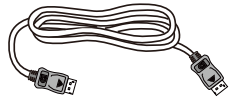

* DP

* Different according to region.
Display design may differ from those illustrated.

1

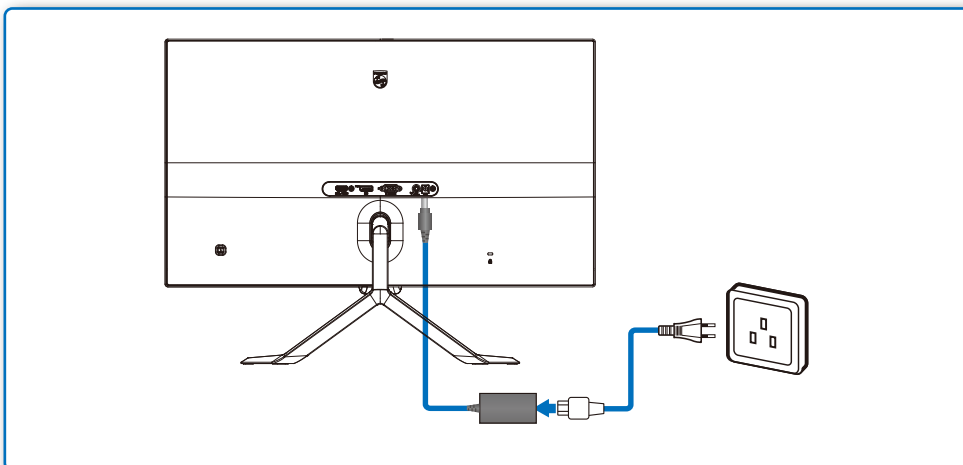

2

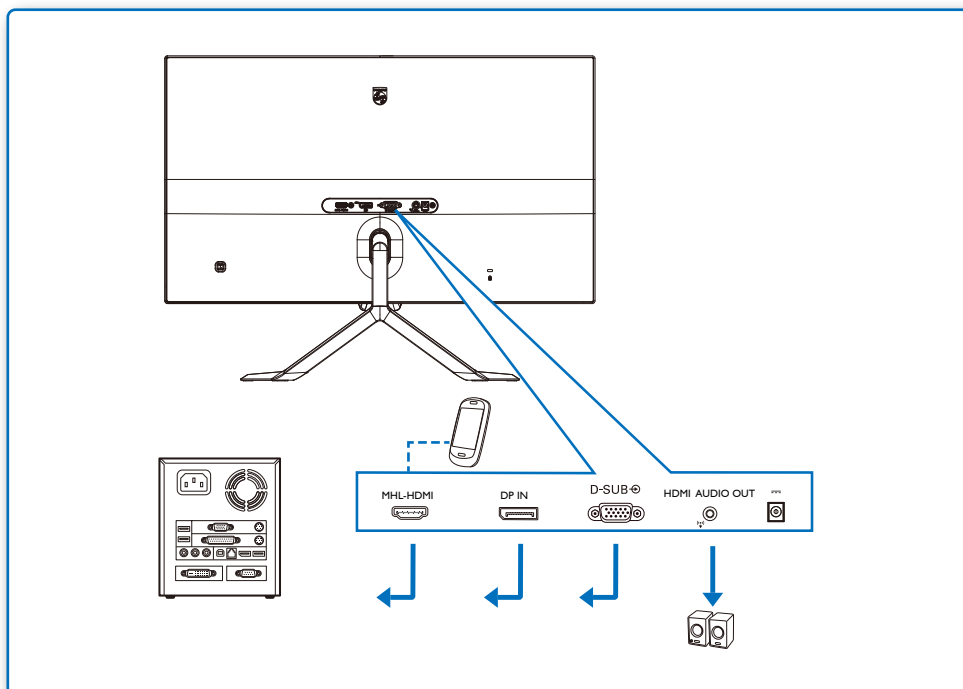

- ⑩ Note: To find a list of MHL-certified devices, visit the official MHL website (<http://www.mhlconsortium.org>)
- ⑩ 注意: 如需取得MHL认证的设备的列表, 请访问MHL官方网站 (<http://www.mhlconsortium.org>)
- ⑩ Remarque : Pour la liste des appareils certifiés MHL, visitez le site web officiel de MHL (<http://www.mhlconsortium.org>)
- ⑩ Примітка: щоб знайти список пристроїв з сертифікатом MHL, відвідайте офіційний сайт MHL (<http://www.mhlconsortium.org>)
- ⑩ Nota: Para encontrar una lista de dispositivos con la certificación MHL, visite el sitio Web oficial de MHL (<http://www.mhlconsortium.org>)
- ⑩ Not: MHL onaylı aygıtların listesi için, MHL resmi web sitesini ziyaret edin (<http://www.mhlconsortium.org>)
- ⑩ Hinweis: Eine Liste MHL-zertifizierter Geräte finden Sie auf der offiziellen MHL-Website (<http://www.mhlconsortium.org>)
- ⑩ Примечание: Список устройств, сертифицированных консорциумом MHL, представлен на официальном веб-сайте MHL (<http://www.mhlconsortium.org>)
- ⑩ Nota: Per trovare un elenco di dispositivi certificati MHL, visitate il sito ufficiale MHL (<http://www.mhlconsortium.org>)
- ⑩ चका ई: सलवावर (MHL) कलमिलि उपकरणों की सूची पाने के लिए, आधिकारिक सलवावर वेबसाइट (<http://www.mhlconsortium.org>) पर जाएँ।
- ⑩ Nota: Para encontrar una lista de dispositivos con certificación MHL, visite el sitio Web oficial de MHL (<http://www.mhlconsortium.org>)
- ⑩ ملاحظة: لعرض على قائمة الأجهزة المعتمدة من MHL، قم بزيارة موقع الإنترنت (<http://www.mhlconsortium.org>)
- ⑩ 참고: MHL인증 장치 목록은 MHL 공식 웹사이트(<http://www.mhlconsortium.org>)를 참조하십시오.
- ⑩ 注: MHL認定装置のリストを見つけるには、正規MHL Webサイトにアクセスしてください。 (<http://www.mhlconsortium.org>)

3

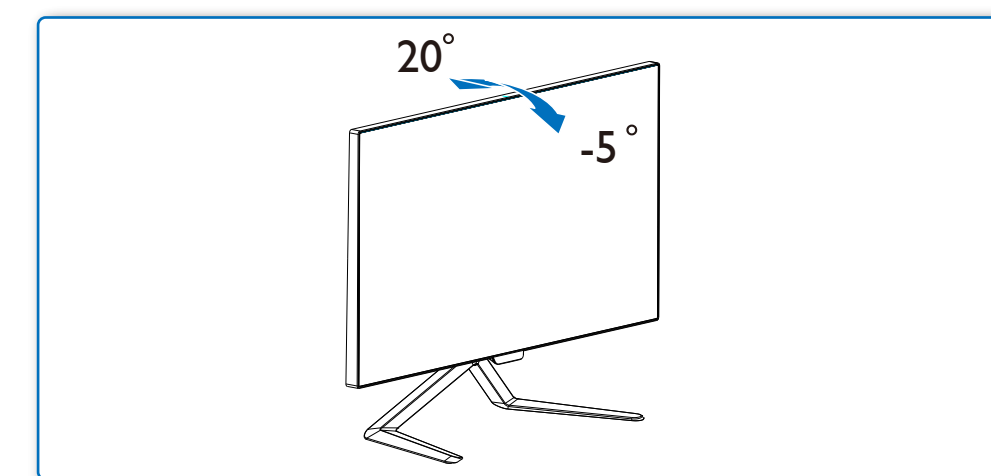

4

