

Brilliance
349X7



www.philips.com/welcome

EN	User manual	1
	Customer care and warranty	21
	Troubleshooting & FAQs	29

PHILIPS

Table of Contents

1. Important	1
1.1 Safety precautions and maintenance	1
1.2 Notational Descriptions	3
1.3 Disposal of product and packing material.....	3
2. Setting up the monitor.....	5
2.1 Installation	5
2.2 Operating the monitor.....	6
2.3 MultiView	10
2.4 Remove the Base Assembly for VESA Mounting.....	12
3. Image Optimization	13
3.1 SmartImage	13
3.2 SmartContrast.....	14
4. FreeSync.....	15
5. Technical Specifications	16
5.1 Resolution & Preset Modes	19
5.2 Crystalclear	19
6. Power Management	20
7. Customer care and warranty ...	21
7.1 Philips' Flat Panel Monitors Pixel Defect Policy.....	21
7.2 Customer Care & Warranty	24
8. Troubleshooting & FAQs.....	29
8.1 Troubleshooting.....	29
8.2 General FAQs.....	30
8.3 Multiview FAQs	32

1. Important

This electronic user's guide is intended for anyone who uses the Philips monitor. Take time to read this user's manual before you use your monitor. It contains important information and notes regarding the operation of your monitor.

The Philips guarantee applies provided the product is handled properly for its intended use, in accordance with its operating instructions and upon presentation of the original invoice or cash receipt, indicating the date of purchase, dealer's name and model and production number of the product.

1.1 Safety precautions and maintenance

Warnings

[Use of controls, adjustments or procedures other than those specified in this documentation may result in exposure to shock, electrical hazards and/or mechanical hazards.](#)

[Read and follow these instructions when connecting and using your computer monitor.](#)

Operation

- Please keep the monitor out of direct sunlight, very strong bright lights and away from any other heat source. Lengthy exposure to this type of environment may result in discoloration and damage to the monitor.
- Remove any object that could fall into ventilation holes or prevent proper cooling of the monitor's electronics.
- Do not block the ventilation holes on the cabinet.
- When positioning the monitor, make sure the power plug and outlet are easily accessible.
- If turning off the monitor by detaching the power cable or DC power cord, wait for 6 seconds before attaching the power cable or DC power cord for normal operation.
- Please use approved power cord provided by Philips at all times. If your power cord is missing, please contact your local service center. (Please refer to Customer Care Consumer Information Center)
- Do not subject the monitor to severe vibration or high impact conditions during operation.
- Do not knock or drop the monitor during operation or transportation.

Maintenance

- To protect your monitor from possible damage, do not put excessive pressure on the monitor panel. When moving your monitor, grasp the frame to lift; do not lift the monitor by placing your hand or fingers on the monitor panel.
- Unplug the monitor if you are not going to use it for an extensive period of time.
- Unplug the monitor if you need to clean it with a slightly damp cloth. The screen may be wiped with a dry cloth when the power is off. However, never use organic solvent, such as, alcohol, or ammonia-based liquids to clean your monitor.
- To avoid the risk of shock or permanent damage to the set, do not expose the monitor to dust, rain, water, or excessive moisture environment.
- If your monitor gets wet, wipe it with dry cloth as soon as possible.

i. Important

- If foreign substance or water gets in your monitor, please turn the power off immediately and disconnect the power cord. Then, remove the foreign substance or water, and send it to the maintenance center.
- Do not store or use the monitor in locations exposed to heat, direct sunlight or extreme cold.
- In order to maintain the best performance of your monitor and use it for a longer lifetime, please use the monitor in a location that falls within the following temperature and humidity ranges.
 - Temperature: 0–40°C 32–104°F
 - Humidity: 20–80% RH

Important information for Burn-in/ Ghost image

- Always activate a moving screen saver program when you leave your monitor unattended. Always activate a periodic screen refresh application if your monitor will display unchanging static content. Uninterrupted display of still or static images over an extended period may cause “burn in”, also known as “after-imaging” or “ghost imaging”, on your screen.
- “Burn-in”, “after-imaging”, or “ghost imaging” is a well-known phenomenon in LCD panel technology. In most cases, the “burned in” or “after-imaging” or “ghost imaging” will disappear gradually over a period of time after the power has been switched off.

Warning

Failure to activate a screen saver, or a periodic screen refresh application may result in severe “burn-in” or “after-image” or “ghost image” symptoms that will not disappear and cannot be

repaired. The damage mentioned above is not covered under your warranty.

Service

- The casing cover should be opened only by qualified service personnel.
- If there is any need for any document for repair or integration, please contact with your local service center. (please refer to the chapter of “Consumer Information Center”)
- For transportation information, please refer to “Technical Specifications”.
- Do not leave your monitor in a car/trunk under direct sun light.

Note

Consult a service technician if the monitor does not operate normally, or you are not sure what procedure to take when the operating instructions given in this manual have been followed.

1.2 Notational Descriptions

The following subsections describe notational conventions used in this document.

Notes, Cautions and Warnings

Throughout this guide, blocks of text may be accompanied by an icon and printed in bold or italic type. These blocks contain notes, cautions or warnings. They are used as follows:

Note

This icon indicates important information and tips that help you make better use of your computer system.

Caution

This icon indicates information that tells you how to avoid either potential damage to hardware or loss of data.

Warning

This icon indicates the potential for bodily harm and tells you how to avoid the problem.

Some warnings may appear in alternate formats and may not be accompanied by an icon. In such cases, the specific presentation of the warning is mandated by the relevant regulatory authority.

1.3 Disposal of product and packing material

Waste Electrical and Electronic Equipment-WEEE



This marking on the product or on its packaging illustrates that, under European Directive 2012/19/EU governing used electrical and electronic appliances, this product may not be disposed of with normal household waste. You are responsible for disposal of this equipment through a designated waste electrical and electronic equipment collection. To determine the locations for dropping off such waste electrical and electronic, contact your local government office, the waste disposal organization that serves your household or the store at which you purchased the product.

Your new monitor contains materials that can be recycled and reused. Specialized companies can recycle your product to increase the amount of reusable materials and to minimize the amount to be disposed of.

All redundant packing material has been omitted. We have done our utmost to make the packaging easily separable into mono materials.

Please find out about the local regulations on how to dispose of your old monitor and packing from your sales representative.

1. Important

Taking back/Recycling Information for Customers

Philips establishes technically and economically viable objectives to optimize the environmental performance of the organization's product, service and activities.

From the planning, design and production stages, Philips emphasizes the important of making products that can easily be recycled. At Philips, end-of-life management primarily entails participation in national take-back initiatives and recycling programs whenever possible, preferably in cooperation with competitors, which recycle all materials (products and related packaging material) in accordance with all Environmental Laws and taking back program with the contractor company.

Your display is manufactured with high quality materials and components which can be recycled and reused.

To learn more about our recycling program please visit:

<http://www.philips.com/a-w/about/sustainability.html>

2. Setting up the monitor

2.1 Installation

1 Package contents

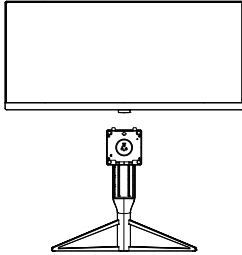

* DP cable

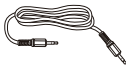

*Audio



AC/DC Adapter

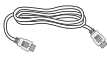

* HDMI cable

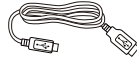

*USB

* Different according to region

Note

Use only AC/DC adapter model: Philips ADPC20120

2 Install base stand

1. Place the monitor face down on soft and smooth surface taking care to avoid scratching or damaging the screen.

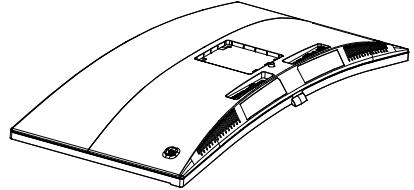

2. Hold the stand with both hands. Gently attach the stand to the VESA mount area until the latch locks the stand.

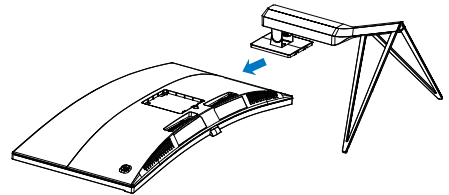

Warning:

This product is curve design, when attach / detach the base, place the protective material under the monitor and do not press down the monitor to avoid the damage.

2. Setting up the monitor

3 Connecting to your computer

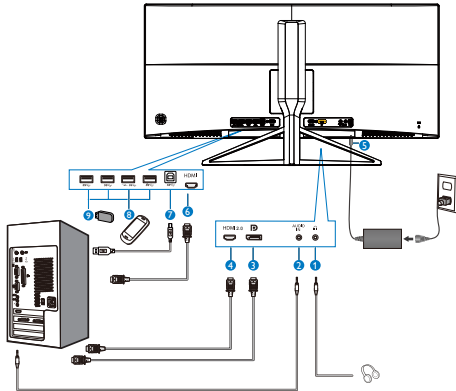

- 1 Earphone jack
- 2 Audio input
- 3 Display port input
- 4 HDMI2.0 input
- 5 AC/DC power input
- 6 HDMI input
- 7 USB upstream
- 8 USB fast charger
- 9 USB downstream

ⓘ Note

USB 2.4Ghz wireless devices, such as, wireless mouse, keyboard, and headphones, maybe have interference by the high-speed signal of USB 3.0 devices, which may result in a decreased efficiency of the radio transmission. Should this happen, please try the following methods to help reduce the effects of interference.

- Try to keep USB2.0 receivers away from USB3.0 connection port.
- Use a standard USB extension cable or USB hub to increase the space between your wireless receiver and the USB3.0 connection port.

2.2 Operating the monitor

1 Description of the control buttons

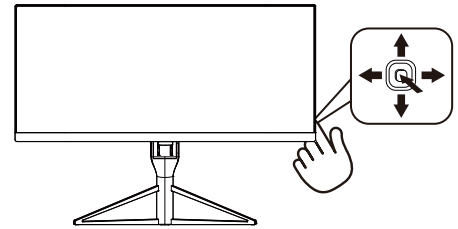

1		Press more than 3 seconds to switch display power OFF. Press to switch display power ON.
2		Access the OSD menu. Confirm the OSD adjustment.
3		User preference key. Customize your own preference function from OSD to become the "user key".
		Adjust the OSD menu.
4		PIP/PBP/Off/Swap
		Adjust the OSD menu.
5		SmartImage hot key. There are 7 modes to select: FPS, Racing, RTS, Gamer 1,Gamer 2, LowBlue Mode,Off.
		Return to previous OSD level.

2. Setting up the monitor

2 Customize your own “USER” key
“USER” allows you to setup your favorite function buttons.

1. Toggle to the right to enter OSD menu screen.

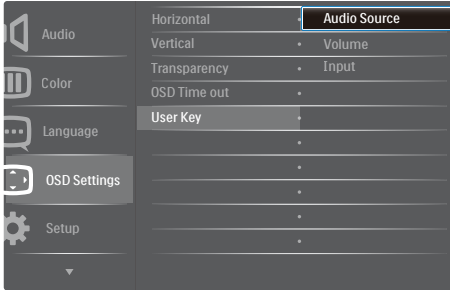

2. Toggle to the up or down to select main menu **[OSD Settings]**, then toggle to the right to confirm.
3. Toggle to the up or down to select **[User Key]**, then toggle to the right to confirm.
4. Toggle to the up or down to select your preferred function : **[Audio Source]**, **[Volume]**, **[Input]**.
5. Toggle to the right to confirm your selection.

Now you can toggle the button at the bottom of the Display bezel to the down **[User Key]** directly. Only your pre-selected function will appear for quick access.

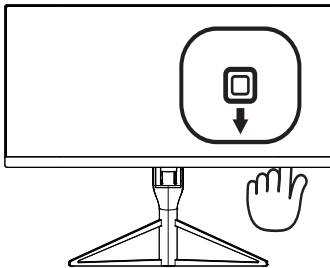

For example, if you selected **[Audio Source]** as the function, toggle down , the **[Audio Source]** menu appears.



3 Independent audio playback, regardless of video input

Your Philips monitor can play the audio source independently under PIP / PBP mode, regardless of which video input. For example, you can play your MP3 player from the audio source connected to the **[Audio In]** port of this monitor, and still watch your video source connected from **[HDMI1.4]**, **[HDMI2.0]** or **[DisplayPort]**.

1. Toggle to the right to enter OSD menu screen.

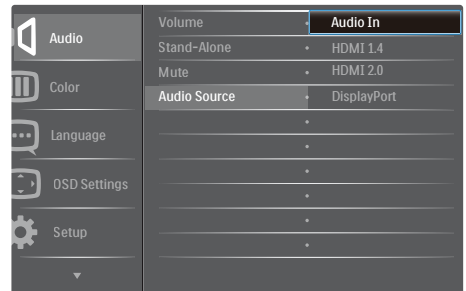

2. Toggle to the up and down to select main menu **[Audio]**, then toggle to the right to confirm.
3. Toggle to the up and down to select **[Audio Source]**, then toggle to the right to confirm.
4. Toggle to the up and down to select your preferred audio source: **[Audio In]**, **[HDMI1.4]**, **[HDMI2.0]** or **[DisplayPort]**.
5. Toggle to the right to confirm your

2. Setting up the monitor

selection.

Note

If you selected Audio-in, the next time you turn on this monitor, it will by default select the same audio source you previously selected. To change it you will have to go through the selection steps again to select your new preferred audio source as the default. This will not occur if DP or HDMI was selected.

4 Description of the On Screen Display

What is On-Screen Display (OSD)?

On-Screen Display (OSD) is a feature in all Philips LCD Displays. It allows an end user to adjust screen performance or select functions of the Displays directly through an on-screen instruction window. A user friendly on screen display interface is shown as below:

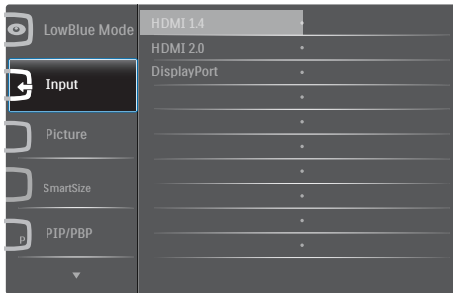

Basic and simple instruction on the control keys

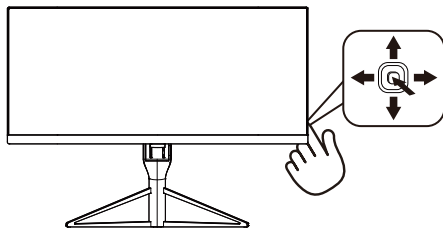

To access the OSD menu on this Philips Display simply use the single toggle button at the bottom of the Display bezel. The single button operates like a joystick. To move the cursor, simply toggle the button in four directions. Press the button to select desired option.

The OSD Menu

Below is an overall view of the structure of the On-Screen Display. You can use this as a reference when you want to work your way around the different adjustments later on.

2. Setting up the monitor

Main menu	Sub menu		
LowBlue Mode	On	1, 2, 3	
	Off		
Input	HDMI 1.4		
	HDMI 2.0		
	DisplayPort		
Picture	Brightness	0-100	
	Contrast	0-100	
	Sharpness	0-100	
	SmartResponse	Off, Fast, Faster, Fastest	
	SmartContrast	On, Off	
	SmartFrame	On, Off	
		Size: 1, 2, 3, 4, 5, 6, 7	
		Brightness: 0-100	
		Contrast: 0-100	
		H. position	
		V. position	
	Gamma	1.8, 2.0, 2.2, 2.4, 2.6	
	Pixel Orbiting	On, Off	
Over Scan	On, Off		
SmartSize	Panel Size	17": (5:4)	
		19": (5:4)	
		19"W: (16:10)	
		22"W: (16:10)	
		18.5"W: (16:9)	
		19.5"W: (16:9)	
		20"W: (16:9)	
		21.5"W: (16:9)	
		23"W: (16:9)	
		24"W: (16:9)	
		27"W: (16:9)	
		34"W(21:9)	
		1:1	
		Aspect	
	PIP/PBP	PIP/PBP Mode	Off, PIP, PBP
PIP/PBP Input		HDMI 1.4, HDMI 2.0, DisplayPort	
PIP Size		Small, Middle, Large	
PIP Position		Top-Right, Top-Left, Bottom-Right, Bottom-Left	
Swap			
Audio	Volume	0-100	
	Stand-Alone	On, Off	
	Mute	On, Off	
	Audio Source	Audio In, HDMI 1.4, HDMI 2.0, DisplayPort	
Color	Color Temperature	5000K, 6500K, 7500K, 8200K, 9300K, 11500K	
	sRGB		
	User Define	Red: 0-100 Green: 0-100 Blue: 0-100	
Language	English, Deutsch, Español, Ελληνική, Français, Italiano, Magyar, Nederlands, Português, Português do Brasil, Polski, Русский, Svenska, Suomi, Türkçe, Čeština, Українська, 简体中文, 繁體中文, 日本語, 한국어		
OSD Settings	Horizontal	0-100	
	Vertical	0-100	
	Transparency	Off, 1, 2, 3, 4	
	OSD Time Out	5s, 10s, 20s, 30s, 60s	
	User Key	Audio Source, Volume, Input	
Setup	Power LED	0, 1, 2, 3, 4	
	Resolution Notification	On, Off	
	DisplayPort	1.1, 1.2	
	Reset	Yes, No	
	Information		

3 Resolution notification

This monitor is designed for optimal performance at its native resolution, 3440 × 1440 @ 60 Hz. When the monitor is powered on at a different resolution, an alert is displayed on screen: Use 3440 × 1440 @ 60 Hz for best results.

Display of the native resolution alert can be switched off from Setup in the OSD (On Screen Display) menu.

4 Physical Function

Tilt

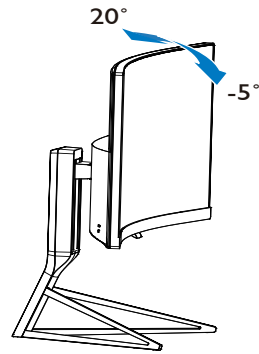

Height adjustment

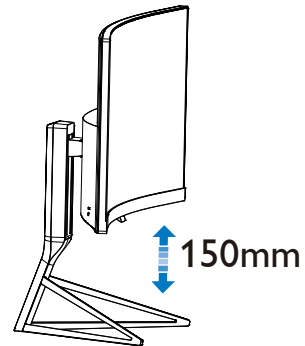

2.3 MultiView



1 What is it?

Multiview enables active variety connect and view so that you can work with multiple devices like PC and Notebook side-by-side simultaneously, making complex multi-tasking work a breeze.

2 Why do I need it?

With the ultra high resolution Philips MultiView display, you can experience a world of connectivity in a comfortable way in the office or at home. With this display, you can conveniently enjoy multiple content sources at one screen. For example: You may want to keep an eye on the live news video feed with audio in the small window, while working on your latest blog, or you may want to edit an Excel file from your Ultrabook, while logged into secured company intranet to access files from a desktop.

3 How to enable MultiView by hotkey?

1. Toggle the button at the bottom of the Display bezel to the up.

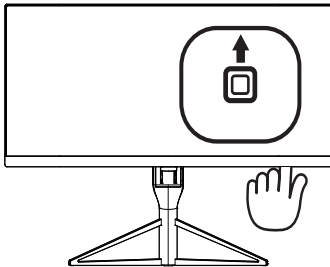

2. The MultiView selection menu

appears. Toggle up or down to select.

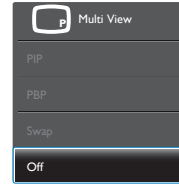

3. Toggle to the right to confirm your selection.

4 How to enable MultiView by OSD menu?

MultiView function can also be selected in OSD menu.

1. Toggle to the right to enter OSD Menu Screen.

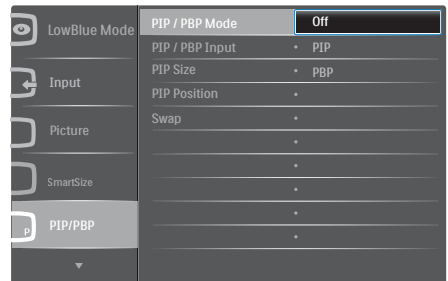

2. Toggle to the up or down to select main menu **[PIP / PBP]**, then toggle to the right to confirm.
3. Toggle to the up or down to select **[PIP / PBP Mode]**, then toggle to the right.
4. Toggle to the up or down to select **[PIP]** or **[PBP]**.
5. Now you can move backward to set the **[PIP / PBP Input]**, **[PIP Size]**, **[PIP Position]**, or **[Swap]**.
6. Toggle to the right to confirm your selection.

2. Setting up the monitor

5 MultiView in OSD menu

- **PIP / PBP Mode:** There are two modes for MultiView: **[PIP]** and **[PBP]**.

[PIP]: Picture in Picture

Open up a sub-window of another signal source.

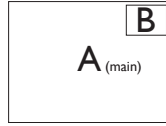

When the sub source is not detected:

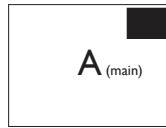

[PBP]: Picture by Picture

Open up a sub-window side-by-side of another signal source.

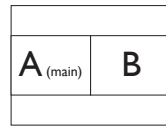

When the sub source is not detected:

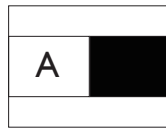

Note

The black strip shows on the top and the bottom of the screen for the correct aspect ratio when in the PBP mode.

- **PIP / PBP Input:** There are three different video input to choose as the sub display source: **[HDMI 1.4]**, **[HDMI 2.0]**, and **[DisplayPort]**.
- **PIP Size:** When PIP is activated, there are three sub-window sizes to choose: **[Small]**, **[Middle]**, **[Large]**.

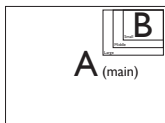

- **PIP Position:** When PIP is activated, there are four sub-window positions to choose.

Top-Right

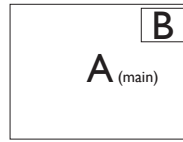

Bottom-Right

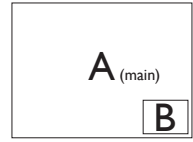

Top-Left

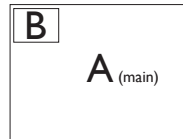

Bottom-Left

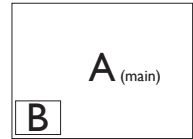

- **Swap:** The main picture source and the sub picture source swapped on the display.

Swap A and B source in **[PIP]** mode:



Swap A and B source in **[PBP]** mode:

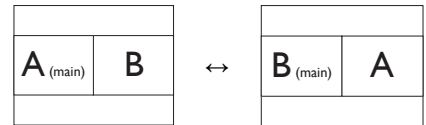

- **Off:** Stop MultiView function.

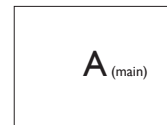

Note

When you do the SWAP function, the video and its audio source will swap at the same time. (Refer to page 7 “**Independent audio playback, regardless of video input**” for more detail.)

2.4 Remove the Base Assembly for VESA Mounting

Before you start disassembling the Display base, please follow the instructions below to avoid any possible damage or injury.

1. Place the monitor face down on soft and smooth surface taking care to avoid scratching or damaging the screen.

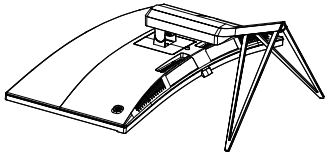

2. While keeping the release button pressed, tilt the base and slide it out.

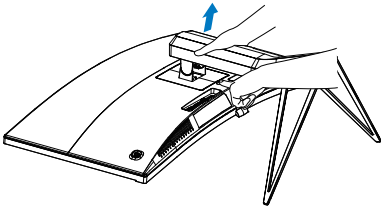

Note

This monitor accepts a 100mm x 100mm VESA-Compliant mounting interface.

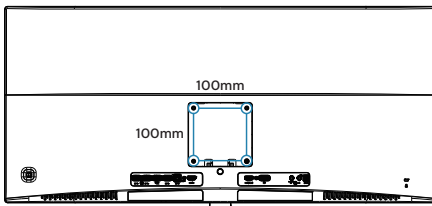

3. Image Optimization

3.1 SmartImage

1 What is it?

SmartImage provides presets that optimize display for different types of content, dynamically adjusting brightness, contrast, color and sharpness in real time. Whether you're working with text applications, displaying images or watching a video, Philips SmartImage delivers great optimized monitor performance.

2 Why do I need it?

You want a monitor that delivers optimized display all your favorite types of content, SmartImage software dynamically adjust brightness, contrast, color and sharpness in real time to enhance your monitor viewing experience.

3 How does it work?

SmartImage is an exclusive, leading edge Philips technology that analyzes the content displayed on your screen. Based on a scenario you select, SmartImage dynamically enhances the contrast, color saturation and sharpness of images to enhance the contents being displayed - all in real time with the press of a single button.

4 How to enable SmartImage?

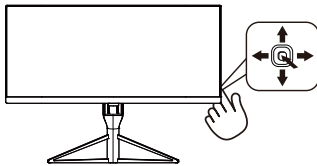

1. Toggle to the left to launch the SmartImage on screen display.

2. Toggle to the up or down to select among FPS, Racing, RTS, Gamer1, Gamer2, LowBlue Mode and Off.
3. The SmartImage on screen display will remain on screen for 5 seconds, or you can also toggle to the left to make confirmation.

There are 7 modes to select: FPS, Racing, RTS, Gamer1, Gamer2, LowBlue Mode and Off.

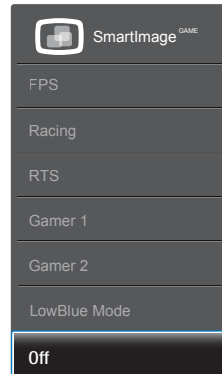

- **FPS:** For playing FPS (First Person Shooters) games. Improves dark theme black level details.
- **Racing:** For playing Racing games. Provides fastest response time and high color saturation.
- **RTS:** For playing RTS (Real Time Strategy) games, a user-selected portion can be highlighted for RTS games (through SmartFrame). The picture quality can be adjusted for the highlighted portion.
- **Gamer 1:** User's preference settings saved as Gamer 1.
- **Gamer 2:** User's preference settings saved as Gamer 2.
- **LowBlue Mode:** LowBlue Mode for easy on-the-eyes productivity. Studies have shown that just as ultra-violet rays can cause eye damage, shortwave length blue light

3. Image Optimization

rays from LED displays can cause eye damage and affect vision over time. Developed for wellbeing, Philips LowBlue Mode setting uses a smart software technology to reduce harmful shortwave blue light.

- **Off:** No optimization by SmartImage^{GAME}.

3.2 SmartContrast

1 What is it?

Unique technology that dynamically analyzes displayed content and automatically optimizes a Monitor's contrast ratio for maximum visual clarity and viewing enjoyment, stepping up backlighting for clearer, crisper and brighter images or dimming backlighting for clear display of images on dark backgrounds.

2 Why do I need it?

You want the very best visual clarity and viewing comfort for every type of content. SmartContrast dynamically controls contrast and adjusts backlighting for clear, crisp, bright gaming and video images or displays clear, readable text for office work. By reducing your monitor's power consumption, you save on energy costs and extend the lifetime of your monitor.

3 How does it work?

When you activate SmartContrast, it will analyse the content you are displaying in real time to adjust colors and control backlight intensity. This function will dynamically enhance contrast for a great entertainment experience when viewing videos or playing games.

4. FreeSync



PC gaming has long been an imperfect experience because GPUs and monitors update at different rates. Sometimes a GPU can render many new pictures during a single update of the monitor, and the monitor will show pieces of each picture as a single image. This is called “tearing.” Gamers can fix tearing with a feature called “v-sync,” but the image can become jerky as the GPU waits on the monitor to call for an update before delivering new pictures.

The responsiveness of mouse input and overall frames per second are reduced with v-sync, too. AMD FreeSync™ technology eliminates all of these problems by letting the GPU update the monitor the moment a new picture is ready, leaving gamers with unbelievably smooth, responsive, tearing-free games.

Followed by the graphic card that are compatible.

- Processor 2014 A-Series Desktop and Mobility APUs
 - AMD A10-7850K
 - AMD A10-7800
 - AMD A10-7700K
 - AMD A8-7600
 - AMD A6-7400K
- Operating system
 - Window7 or 8
 - Graphic Card: R9 290 Series & R7 260 Series
 - AMD Radeon R9 295X2
 - AMD Radeon R9 290X
 - AMD Radeon R9 290
 - AMD Radeon R9 285
 - AMD Radeon R7 260X
 - AMD Radeon R7 260

5. Technical Specifications

Picture/Display	
Monitor Panel Type	MVA
Backlight	LED
Panel Size	34" W (86.7 cm)
Aspect Ratio	21:9
Pixel Pitch	0.232 x 0.232 mm
SmartContrast	50,000,000:1
Response Time (typ.)	16 ms(GtG)
SmartResponse	4 ms (GtG)
Optimum Resolution	HDMI 1.4 :3440x1440 @ 60Hz 2560x1080 @ 95Hz Displayport/HDMI 2.0 :3440x1440 @ 60Hz 3440x1440 @ 100Hz
Viewing Angle	178° (H) / 178° (V)(typ.) @ C/R > 10
Picture Enhancement	SmartImage
Vertical Refresh Rate	40Hz - 100Hz
Horizontal Frequency	58kHz - 148kHz
sRGB	YES
LowBlue Mode	YES
Monitor Colors	16.7M
Flicker free	YES
Color gamut	sRGB 99.5%
Freesync	YES
Connectivity	
Signal Input	DisplayPort, 1.2x1 HDMI 1.4x1(digital,HDCP) HDMI 2.0x1(digital,HDCP)
USB	USB 3.0x4 (1 with BC1.2 fast charging)
Input Signal	Separate Sync, Sync on Green
Audio In/Out	PC audio-in,headphone out
Convenience	
Built-in speaker	5 W x 2
OSD Languages	English, German, Spanish, Greek, French, Italian, Hungarian, Dutch, Portuguese, Brazil Portuguese, Polish, Russian, Swedish, Finnish, Turkish, Czech, Ukrainian, Simplified Chinese, Traditional Chinese, Japanese, Korean
Other Convenience	VESA mount(100 × 100 mm), Kensington Lock
Plug & Play Compatibility	DDC/CI, sRGB, Windows 10/8.1/8/7, Mac OSX
Stand	
Tilt	-5° / +20°
Height adjustment	150mm

5. Technical Specifications

Power			
Consumption	AC Input Voltage at 100VAC , 50Hz	AC Input Voltage at 115VAC , 60Hz	AC Input Voltage at 230VAC, 50Hz
Normal Operation	69.45 W (typ.)	69.55 W (typ.)	69.65 W (typ.)
Sleep (Standby)	0.3 W (typ.)	0.3 W (typ.)	0.3 W (typ.)
Off	0.3 W (typ.)	0.3 W (typ.)	0.3 W (typ.)
Heat Dissipation*	AC Input Voltage at 100VAC , 50Hz	AC Input Voltage at 115VAC , 60Hz	AC Input Voltage at 230VAC , 50Hz
Normal Operation	237.03 BTU/hr (typ.)	237.37 BTU/hr (typ.)	237.71 BTU/hr (typ.)
Sleep (Standby)	1.02 BTU/hr (typ.)	1.02 BTU/hr (typ.)	1.02 BTU/hr (typ.)
Off	1.02 BTU/hr (typ.)	1.02 BTU/hr (typ.)	1.02 BTU/hr (typ.)
Power LED indicator	On mode: White, Standby/Sleep mode: White (blinking)		
Power Supply	External, 100–240VAC, 50–60Hz		

Dimension	
Product with stand (WxHxD)	810 x 444 x 292 mm
Product without stand (WxHxD)	810 x 369 x 98 mm
Product with packaging (WxHxD)	946 x 576 x 388 mm

Weight	
Product with stand	8.21 kg
Product without stand	6.43 kg
Product with packaging	13.74 kg

Operating Condition	
Temperature range (operation)	0°C to 40 °C
Relative humidity (operation)	20% to 80%
Atmospheric pressure (operation)	700 to 1060hPa
Temperature range (Non-operation)	-20°C to 60°C
Relative humidity (Non-operation)	10% to 90%
Atmospheric pressure (Non-operation)	500 to 1060hPa

Environmental

5. Technical Specifications

ROHS	YES
Packaging	100 % recyclable
Specific Substances	100 % PVC BFR free housing
Compliance and standards	
Regulatory Approvals	CE Mark, FCC Class B, CU-EAC, RCM, CCC
Cabinet	
Color	White
Finish	Glossy

Note

1. This data is subject to change without notice. Go to www.philips.com/support to download the latest version of leaflet.
2. Smart response time is the optimum value from either GtG or GtG (BW) tests.

5.1 Resolution & Preset Modes

1 Maximum Resolution

3440x1440@100Hz (DP/HDMI 2.0)
3440x1440@60Hz (HDMI 1.4)

2 Recommended Resolution

3440x1440@60Hz (HDMI/DP)

H. freq (kHz)	Resolution	V. freq (Hz)
31.47	720 x 400	70.09
31.47	640 x 480	59.94
35.00	640 x 480	66.67
37.86	640 x 480	72.81
37.50	640 x 480	75.00
50.90	640 x 480	100.00
35.16	800 x 600	56.00
37.88	800 x 600	60.32
48.08	800 x 600	72.00
46.88	800 x 600	75.00
63.60	800 x 600	100.00
47.73	832x624	75.00
48.36	1024 x 768	60.00
56.48	1024 x 768	70.00
60.02	1024 x 768	75.03
81.40	1024 x 768	100.00
44.77	1280x 720	59.86
63.89	1280 x 1024	60.02
79.98	1280 x 1024	75.03
55.94	1440 x 900	59.89
65.29	1680 x 1050	59.95
89.48	1720 x 1440	59.94
67.50	1920 x 1080	60.00
44.74	3440 x 1440	29.97
89.48	3440 x 1440	59.94
150.97	3440 x 1400	100.00

Note

- Please notice that your display works best at native resolution of 3440 x 1440@ 60Hz. For best display quality, please follow this resolution recommendation.
- The highest supporting screen resolution on HDMI is 3440 x 1440 , but it always depends on your capability of graphics card and BluRay/video players.
- On DisplayPort Mode, can't support FreeSync if the V.Freq>69Hz

5.2 Crystalclear

This latest Philips display delivers Crystalclear, 3440 x 1440 images. Utilizing high performance panels with high density pixel count, 178/178 wide viewing angles, enabled by high bandwidth sources like Displayport, HDMI, this new display will make your images and graphics come alive. Whether you are demanding professional requiring extremely detailed information for CAD-CAM solutions, using 3D graphic applications or a financial wizard working on huge spreadsheets, this Philips display will give you Crystalclear images.

6. Power Management

If you have VESA DPM compliance display card or software installed in your PC, the monitor can automatically reduce its power consumption when not in use. If an input from a keyboard, mouse or other input device is detected, the monitor will 'wake up' automatically. The following table shows the power consumption and signaling of this automatic power saving feature:

Power Management Definition					
VESA Mode	Video	H-sync	V-sync	Power Used	LED Color
Active	ON	Yes	Yes	69.55 W (typ.), 109.4 W (max.)	White
Sleep (Standby)	OFF	No	No	0.3 W (typ.)	White (blink)
Off	OFF	-	-	0.3 W (typ.)	OFF

The following setup is used to measure power consumption on this monitor.

- Native resolution: 3440 x 1440
- Contrast: 50%
- Brightness: 100%
- Color temperature: 6500k with full white pattern

Note

This data is subject to change without notice.

7. Customer care and warranty

7.1 Philips' Flat Panel Monitors Pixel Defect Policy

Philips strives to deliver the highest quality products. We use some of the industry's most advanced manufacturing processes and practice stringent quality control. However, pixel or sub pixel defects on the TFT Monitor panels used in flat panel monitors are sometimes unavoidable. No manufacturer can guarantee that all panels will be free from pixel defects, but Philips guarantees that any monitor with an unacceptable number of defects will be repaired or replaced under warranty. This notice explains the different types of pixel defects and defines acceptable defect levels for each type. In order to qualify for repair or replacement under warranty, the number of pixel defects on a TFT Monitor panel must exceed these acceptable levels. For example, no more than 0.0004% of the sub pixels on a monitor may be defective. Furthermore, Philips sets even higher quality standards for certain types or combinations of pixel defects that are more noticeable than others. This policy is valid worldwide.

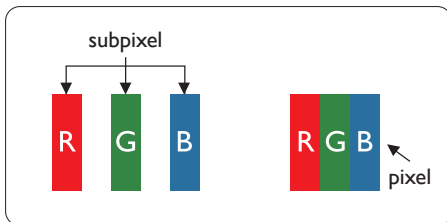

Pixels and Sub pixels

A pixel, or picture element, is composed of three sub pixels in the primary colors

of red, green and blue. Many pixels together form an image. When all sub pixels of a pixel are lit, the three colored sub pixels together appear as a single white pixel. When all are dark, the three colored sub pixels together appear as a single black pixel. Other combinations of lit and dark sub pixels appear as single pixels of other colors.

Types of Pixel Defects

Pixel and sub pixel defects appear on the screen in different ways. There are two categories of pixel defects and several types of sub pixel defects within each category.

Bright Dot Defects

Bright dot defects appear as pixels or sub pixels that are always lit or 'on'. That is, a bright dot is a sub-pixel that stands out on the screen when the monitor displays a dark pattern. There are the types of bright dot defects.

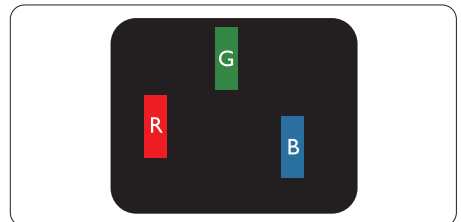

One lit red, green or blue sub pixel.

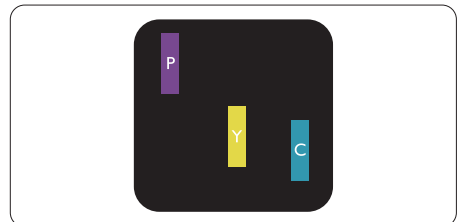

Two adjacent lit sub pixels:

- Red + Blue = Purple
- Red + Green = Yellow
- Green + Blue = Cyan (Light Blue)

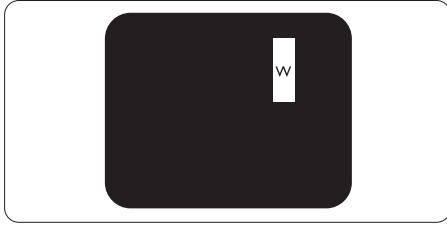

Three adjacent lit sub pixels (one white pixel).

Note

A red or blue bright dot must be more than 50 percent brighter than neighboring dots while a green bright dot is 30 percent brighter than neighboring dots.

Black Dot Defects

Black dot defects appear as pixels or sub pixels that are always dark or 'off'. That is, a dark dot is a sub-pixel that stands out on the screen when the monitor displays a light pattern. These are the types of black dot defects.

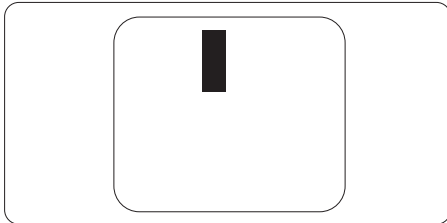

Proximity of Pixel Defects

Because pixel and sub pixels defects of the same type that are near to one another may be more noticeable, Philips also specifies tolerances for the proximity of pixel defects.

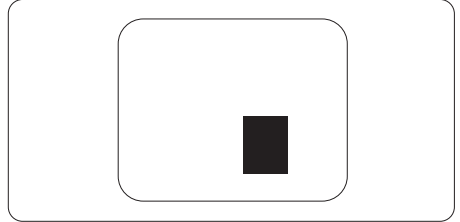

Pixel Defect Tolerances

In order to qualify for repair or replacement due to pixel defects during the warranty period, a TFT Monitor panel in a Philips flat panel monitor must have pixel or sub pixel defects exceeding the tolerances listed in the following tables.

7. Customer care and warranty

BRIGHT DOT DEFECTS	ACCEPTABLE LEVEL
1 lit subpixel	3
2 adjacent lit subpixels	1
3 adjacent lit subpixels (one white pixel)	0
Distance between two bright dot defects*	>15mm
Total bright dot defects of all types	3

BLACK DOT DEFECTS	ACCEPTABLE LEVEL
1 dark subpixel	5 or fewer
2 adjacent dark subpixels	2 or fewer
3 adjacent dark subpixels	0
Distance between two black dot defects*	>15mm
Total black dot defects of all types	5 or fewer

TOTAL DOT DEFECTS	ACCEPTABLE LEVEL
Total bright or black dot defects of all types	5 or fewer

Note

- 1 or 2 adjacent sub pixel defects = 1 dot defect

7.2 Customer Care & Warranty

For warranty coverage information and additional support requirements valid for your region, please visit www.philips.com/support website for details or contact your local Philips Customer Care Center.

For extended warranty, if you would like to extend your general warranty period, an Out of Warranty service package is offered via our Certified Service Center.

If you wish to make use of this service, please be sure to purchase the service within 30 calendar days of your original purchase date. During the extended warranty period, the service includes pickup, repair and return service, however the user will be responsible for all costs accrued.

If the Certified Service Partner cannot perform the required repairs under the offered extended warranty package, we will find alternative solutions for you, if possible, up to the extended warranty period you have purchased.

Please contact our Philips Customer Service Representative or local contact center (by Consumer care number) for more details.

Philips Customer Care Center number listed below.

• Local Standard Warranty Period	• Extended Warranty Period	• Total Warranty Period
• Depend on different Regions	• + 1 Year	• Local Standard warranty period +1
	• + 2 Years	• Local Standard warranty period +2
	• + 3 Years	• Local Standard warranty period +3

**Proof of original purchase and extended warranty purchase required.

Contact Information for WESTERN EUROPE region:

Country	CSP	Hotline Number	Price	Opening hours
Austria	RTS	+43 0810 000206	€ 0.07	Mon to Fri : 9am - 6pm
Belgium	Ecare	+32 078 250851	€ 0.06	Mon to Fri : 9am - 6pm
Cyprus	Alman	800 92 256	Free of charge	Mon to Fri : 9am - 6pm
Denmark	Infocare	+45 3525 8761	Local call tariff	Mon to Fri : 9am - 6pm
Finland	Infocare	+358 09 2290 1908	Local call tariff	Mon to Fri : 9am - 6pm

7. Customer care and warranty

France	Mainteq	+33 082161 1658	€ 0.09	Mon to Fri : 9am - 6pm
Germany	RTS	+49 01803 386 853	€ 0.09	Mon to Fri : 9am - 6pm
Greece	Alman	+00800 4414 4670	Free of charge	Mon to Fri : 9am - 6pm
Ireland	Celestica	+353 01 601 1161	Local call tariff	Mon to Fri : 8am - 5pm
Italy	Anovo Italy	+39 840 320 041 € 0.08	€ 0.08	Mon to Fri : 9am - 6pm
Luxembourg	Ecare	+352 26 84 30 00	Local call tariff	Mon to Fri : 9am - 6pm
Netherlands	Ecare	+31 0900 0400 063	€ 0.10	Mon to Fri : 9am - 6pm
Norway	Infocare	+47 2270 8250	Local call tariff	Mon to Fri : 9am - 6pm
Poland	MSI	+48 0223491505	Local call tariff	Mon to Fri : 9am - 6pm
Portugal	Mainteq	800 780 902	Free of charge	Mon to Fri : 8am - 5pm
Spain	Mainteq	+34 902 888 785	€ 0.10	Mon to Fri : 9am - 6pm
Sweden	Infocare	+46 08 632 0016	Local call tariff	Mon to Fri : 9am - 6pm
Switzerland	ANOVO CH	+41 02 2310 2116	Local call tariff	Mon to Fri : 9am - 6pm
United Kingdom	Celestica	+44 0207 949 0069	Local call tariff	Mon to Fri : 8am - 5pm

7. Customer care and warranty

Contact Information for CENTRAL AND EASTERN EUROPE region:

Country	Call center	CSP	Consumer care number
Belarus	N/A	IBA	+375 17 217 3386 +375 17 217 3389
Bulgaria	N/A	LAN Service	+359 2 960 2360
Croatia	N/A	MR Service Ltd	+385 (01) 640 1111
Czech Rep.	N/A	Asupport	420 272 188 300
Estonia	N/A	FUJITSU	+372 6519900(General) +372 6519972(workshop)
Georgia	N/A	Esabi	+995 322 91 34 71
Hungary	N/A	Profi Service	+36 1 814 8080(General) +36 1814 8565(For AOC&Philips only)
Kazakhstan	N/A	Classic Service I.l.c.	+7 727 3097515
Latvia	N/A	ServiceNet LV	+371 67460399 +371 27260399
Lithuania	N/A	UAB Servicenet	+370 37 400160(general) +370 7400088 (for Philips)
Macedonia	N/A	AMC	+389 2 3125097
Moldova	N/A	Comel	+37322224035
Romania	N/A	Skin	+40 21 2101969
Russia	N/A	CPS	+7 (495) 645 6746
Serbia&Montenegro	N/A	Kim Tec d.o.o.	+381 11 20 70 684
Slovakia	N/A	Datalan Service	+421 2 49207155
Slovenia	N/A	PC H.and	+386 1 530 08 24
the republic of Belarus	N/A	ServiceBy	+ 375 17 284 0203
Turkey	N/A	Tecpro	+90 212 444 4 832
Ukraine	N/A	Topaz	+38044 525 64 95
	N/A	Comel	+380 5627444225

Contact Information for LATIN AMERICA region:

Country	Call center	Consumer care number
Brazil	Vermont	0800-7254101
Argentina		0800 3330 856

7. Customer care and warranty

Contact Information for China:

Country	Call center	Consumer care number
China	PCCW Limited	4008 800 008

Contact Information for NORTH AMERICA :

Country	Call center	Consumer care number
U.S.A.	EPI - e-center	(877) 835-1838
Canada	EPI - e-center	(800)479-6696

Contact Information for APMEA region:

Country	ASP	Consumer care number	Opening hours
Australia	AGOS NETWORK PTY LTD	1300 360 386	Mon.~Fri. 9:00am-5:30pm
New Zealand	Visual Group Ltd.	0800 657447	Mon.~Fri. 8:30am-5:30pm
Hong Kong Macau	Company: Smart Pixels Technology Ltd.	Hong Kong: Tel: +852 2619 9639 Macau: Tel: (853)-0800-987	Mon.~Fri. 9:00am-6:00pm Sat. 9:00am-1:00pm
India	REDINGTON INDIA LTD	Tel: 1 800 425 6396 SMS: PHILIPS to 56677	Mon.~Fri. 9:00am-5:30pm
Indonesia	PT. CORMIC SERVISINDO PERKASA	+62-21-4080-9086 (Customer Hotline) +62-8888-01-9086 (Customer Hotline)	Mon.~Thu. 08:30-12:00; 13:00-17:30 Fri. 08:30-11:30; 13:00-17:30 "
Korea	Alphascan Displays, Inc	1661-5003	Mon.~Fri. 9:00am-5:30pm Sat. 9:00am-1:00pm
Malaysia	R-Logic Sdn Bhd	+603 5102 3336	Mon.~Fri. 8:15am-5:00pm Sat. 8:30am-12:30am
Pakistan	TVONICS Pakistan	+92-213-6030100	Sun.~Thu. 10:00am-6:00pm
Singapore	Philips Singapore Pte Ltd (Philips Consumer Care Center)	(65) 6882 3966	Mon.~Fri. 9:00am-6:00pm Sat. 9:00am-1:00pm
Taiwan	FETEC.CO	0800-231-099	Mon.~Fri. 09:00 - 18:00

7. Customer care and warranty

Thailand	Axis Computer System Co., Ltd.	(662) 934-5498	Mon.~Fri. 08:30am - 05:30pm
South Africa	Computer Repair Technologies	011 262 3586	Mon.~ Fri. 08:00am-05:00pm
Israel	Eastronics LTD	1-800-567000	Sun.~Thu. 08:00-18:00
Vietnam	FPT Service Informatic Company Ltd. - Ho Chi Minh City Branch	+84 8 38248007 Ho Chi Minh City +84 5113.562666 Danang City +84 5113.562666 Can tho Province	Mon.~Fri. 8:00-12:00, 13:30-17:30 Sat. 8:00-12:00
Philippines	EA Global Supply Chain Solutions ,Inc.	(02) 655-7777; 6359456	Mon.~Fri. 8:30am - 5:30pm
Armenia Azerbaijan Georgia Kyrgyzstan Tajikistan	Firebird service centre	+97 14 8837911	Sun.~Thu. 09:00 - 18:00
Uzbekistan	Soniko Plus Private Enterprise Ltd	+99871 2784650	Mon.~Fri. 09:00 - 18:00
Turkmenistan	Technostar Service Centre	+(99312) 460733, 460957	Mon.~Fri. 09:00 - 18:00
Japan	フィリップスモニター ・サポートセンター	0120-060-530	Mon.~Fri. 10:00 - 17:00

8. Troubleshooting & FAQs

8.1 Troubleshooting

This page deals with problems that can be corrected by a user. If the problem still persists after you have tried these solutions, contact Philips customer service representative.

1 Common Problems

No Picture (Power LED not lit)

- Make sure the power cord is plugged into the power outlet and into the back of the monitor.
- First, ensure that the power button on the front of the monitor is in the OFF position, then press it to the ON position.

No Picture (Power LED is White)

- Make sure the computer is turned on.
- Make sure the signal cable is properly connected to your computer.
- Make sure the monitor cable has no bent pins on the connect side. If yes, repair or replace the cable.
- The Energy Saving feature may be activated

Screen says

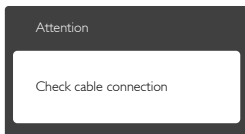

- Make sure the monitor cable is properly connected to your computer. (Also refer to the Quick Start Guide).

- Check to see if the monitor cable has bent pins.
- Make sure the computer is turned on.

Visible signs of smoke or sparks

- Do not perform any troubleshooting steps
- Disconnect the monitor from mains power source immediately for safety
- Contact with Philips customer service representative immediately.

2 Imaging Problems

Image vibrates on the screen

- Check that the signal cable is properly securely connected to the graphics board or PC.

Image appears blurred, indistinct or too dark

- Adjust the contrast and brightness on On-Screen Display.

An "after-image", "burn-in" or "ghost image" remains after the power has been turned off.

- Uninterrupted display of still or static images over an extended period may cause "burn in", also known as "after-imaging" or "ghost imaging", on your screen. "Burn-in", "after-imaging", or "ghost imaging" is a well-known phenomenon in monitor panel technology. In most cases, the "burned in" or "after-imaging" or "ghost imaging" will disappear gradually over a period of time after the power has been switched off.
- Always activate a moving screen saver program when you leave your monitor unattended.
- Always activate a periodic screen refresh application if your monitor will display unchanging static content.

8. Troubleshooting & FAQs

- Failure to activate a screen saver, or a periodic screen refresh application may result in severe “burn-in” or “after-image” or “ghost image” symptoms that will not disappear and cannot be repaired. The damage mentioned above is not covered under your warranty.

Image appears distorted. Text is fuzzy or blurred.

- Set the PC’s display resolution to the same mode as monitor’s recommended screen native resolution.

Green, red, blue, dark, and white dots appears on the screen

- The remaining dots are normal characteristic of the liquid crystal used in today’s technology, Please refer the pixel policy for more detail.

3 Audio problem

No sound

- Check if audio cable is connected to PC and monitor correctly.
- Ensure audio is not muted. Press OSD “Menu”, select “Audio” then “Mute”. Check it on “Off” position.
- Press “Volume” in OSD main control to adjust the volume.

8.2 General FAQs

Q1: When I install my monitor what should I do if the screen shows 'Cannot display this video mode'?

Ans.: Recommended resolution for this monitor: 3440 x 1440 @ 60 Hz.

- Unplug all cables, then connect your PC to the monitor that you used previously.
- In the Windows Start Menu, select Settings/Control Panel. In the

Control Panel Window, select the Display icon. Inside the Display Control Panel, select the 'Settings' tab. Under the setting tab, in box labelled 'desktop area', move the sidebar to 3440 x 1440 pixels.

- Open 'Advanced Properties' and set the Refresh Rate to 60 Hz, then click OK.
- Restart your computer and repeat step 2 and 3 to verify that your PC is set at 3440 x 1440 @ 60 Hz.
- Shut down your computer, disconnect your old monitor and reconnect your Philips monitor.
- Turn on your monitor and then turn on your PC.

Q2: What is the recommended refresh rate for monitor?

Ans.: Recommended refresh rate in monitors is 60 Hz, In case of any disturbance on screen, you can set it up to 75 Hz to see if that removes the disturbance.

Q3: What are the .inf and .icm files on the user manual? How do I install the drivers (.inf and .icm)?

Ans.: These are the driver files for your monitor. Follow the instructions in your user manual to install the drivers. Your computer may ask you for monitor drivers (.inf and .icm files) or a driver disk when you first install your monitor.

Q4: How do I adjust the resolution?

Ans.: Your video card/graphic driver and monitor together determine the available resolutions. You can select the desired resolution under Windows® Control Panel with the "Display properties".

Q5: What if I get lost when I am making monitor adjustments via OSD?

Ans.: Simply press the **➡** button, then select [Reset] to recall all the original factory settings.

Q6: Is the monitor screen resistant to scratches?

Ans.: In general it is recommended that the panel surface is not subjected to excessive shocks and is protected from sharp or blunt objects. When handling the monitor, make sure that there is no pressure or force applied to the panel surface side. This may affect your warranty conditions.

Q7: How should I clean the monitor surface?

Ans.: For normal cleaning, use a clean, soft cloth. For extensive cleaning, please use isopropyl alcohol. Do not use other solvents such as ethyl alcohol, ethanol, acetone, hexane, etc.

Q8: Can I change the color setting of my monitor?

Ans.: Yes, you can change your color setting through OSD control as the following procedures:

- Press **➡** button to show the OSD (On Screen Display) menu
- Press **↓** button to select the option [Color] then press **➡** button to enter color setting, there are three settings as below.
 1. Color Temperature: The six settings are 5000K, 6500K, 7500K, 8200K, 9300K and 11500K. With settings in the 5000K range the panel appears "warm, with a red-white color tone", while a 11500K

temperature yields "cool, bluishwhite toning".

2. sRGB: This is a standard setting for ensuring correct exchange of colors between different device (e.g. digital cameras, monitors, printers, scanners, etc).
3. User Define: The user can choose his/her preference color setting by adjusting red, green blue color.

Note

A measurement of the color of light radiated by an object while it is being heated. This measurement is expressed in terms of absolute scale, (degrees Kelvin). Lower Kelvin temperatures such as 2004K are red; higher temperatures such as 9300K are blue. Neutral temperature is white, at 6504K.

Q9: Can I connect my monitor to any PC, workstation or Mac?

Ans.: Yes. All Philips monitors are fully compatible with standard PCs, Macs and workstations. You may need a cable adapter to connect the monitor to your Mac system. Please contact your Philips sales representative for more information.

Q10: Are Philips monitors Plug-and-Play?

Ans.: Yes, the monitors are Plug-and-Play compatible with Windows10/8.1/8/7, Mac OSX

Q11: What is Image Sticking, or Image Burn-in, or After Image, or Ghost Image in monitor panels?

Ans.: Uninterrupted display of still or static images over an extended period may cause "burn in", also known as "after-imaging" or "ghost imaging", on your screen.

"Burn-in", "after-imaging", or "ghost imaging" is a well-known phenomenon in monitor panel technology. In most cases, the "burned in" or "after-imaging" or "ghost imaging" will disappear gradually over a period of time after the power has been switched off.

Always activate a moving screen saver program when you leave your monitor unattended.

Always activate a periodic screen refresh application if your monitor will display unchanging static content.

 **Warning**

Failure to activate a screen saver, or a periodic screen refresh application may result in severe "burn-in" or "after-image" or "ghost image" symptoms that will not disappear and cannot be repaired. The damage mentioned above is not covered under your warranty.

Q12: Why is my Display not showing sharp text, and is displaying jagged characters?

Ans.: Your monitor works best at its native resolution of 3440 x 1440 @ 60 Hz. For best display, please use this resolution.

8.3 Multiview FAQs

Q1: Can I enlarge the PIP sub window ?

Ans.: Yes, there are 3 sizes to select: [**Small**], [**Middle**], [**Large**]. You can toggle to the right to enter OSD menu. Select your preferred [**PIP Size**] option from the [**PIP / PBP**] main menu.

Q2: How to listen to Audio, independent of video?

Ans.: Normally the audio source is linked to the main picture source. If you want to change audio-source input (for example: listen to your MP3 player independently regardless of the video source input), you can toggle to the right to enter OSD menu. Select your preferred [**Audio Source**] option from the [**Audio**] main menu.

Please note that, if you selected Audio-in, the next time you turn on this monitor, it will by default select the same audio source you previously selected. To change it you will have to go through the selection steps again to select your new preferred audio source as the default. This will not occur if DP or HDMI was selected.

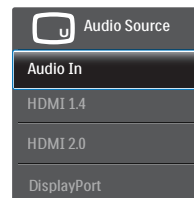



© 2016 Koninklijke Philips N.V. All rights reserved.

Philips and the Philips Shield Emblem are registered trademarks of Koninklijke Philips N.V. and are used under license from Koninklijke Philips N.V.

Specifications are subject to change without notice.

Version: M7349XF1T