

SAMSUNG

USER MANUAL

3 SERIES
V27F390FE* | V32F390FE*

Thank you for purchasing this Samsung product.

To receive more complete service, please register your product at www.samsung.com/register

Model _____ Serial No. _____

Digital TV notice

1. Functionalities related to Digital TV (DVB) are only available in countries/areas where DVB-T/T2 (MPEG2 and MPEG4 AVC) digital terrestrial signals are broadcasted or where you are able to access to a compatible DVB-C (MPEG2 and MPEG4 AAC) cable-TV service. Please check with your local dealer the possibility to receive DVB-T/T2 or DVB-C signal.
2. DVB-T/T2 is the DVB European consortium standard for the broadcast transmission of digital terrestrial television and DVB-C is that for the broadcast transmission of digital TV over cable. However, some differentiated features like EPG (Electric Programme Guide), VOD (Video On Demand) and so on, are not included in this specification. So, they cannot be workable at this moment.
3. Although this TV set meets the latest DVB-T/T2 and DVB-C standards, as of [August, 2008], the compatibility with future DVB-T/T2 digital terrestrial and DVB-C digital cable broadcasts cannot be guaranteed.
4. Depending on the countries/areas where this TV set is used some cable-TV providers may charge an additional fee for such a service and you may be required to agree to terms and conditions of their business.
5. Some Digital TV functions might be unavailable in some countries or regions and DVB-C might not work correctly with some cable service providers.
6. For more information, please contact your local Samsung customer care centre.
 - ✎ The reception quality of TV may be affected due to differences in broadcasting method between the countries. Please check the TV performance in the local SAMSUNG Authorised Dealer, or the Samsung Call Centre whether it can be improved by reconfiguring TV setting or not.

Still image warning

Avoid displaying still images (like jpeg picture files) or still image element (like TV programme logo, panorama or 4:3 image format, stock or news bar at screen bottom etc.) on the screen. Constant displaying of still picture can cause ghosting of LED screen, which will affect image quality. To reduce risk of this effect, please follow below recommendations:

- Avoid displaying the same TV channel for long periods.
- Always try do display any image on full screen, use TV set picture format menu for best possible match.
- Reduce brightness and contrast values to minimum required to achieve desired picture quality, exceeded values may speed up the burnout process.

Contents

Getting Started

Safety Precautions.....	4
Providing Proper Ventilation for Your Product.....	12
Accessories and Cables	13
Using the Control Panel	16
The Standard Remote Control Buttons	17
How to Navigate Menus	19
Connecting the Power Cord and the Aerial or Cable Connection.....	20

Connections

Connecting to AV Devices (Blu-ray Players, DVD Players, etc.)	21
Connecting to Audio Devices.....	24
Connecting to a PC	25
Connecting to a COMMON INTERFACE slot (Your product viewing Card Slot)	26
Changing the Input Source	28

Basic Features

Correct posture to use the product	29
Changing the Preset Picture Mode	30
Adjusting Picture Settings.....	31
Changing the Picture Size	32
Calibrating the Screen Display.....	34
Picture In Picture (PIP).....	35
Changing the Picture Options	36
Changing the Preset Sound Mode.....	38
Adjusting Sound Settings	39
Memorising Channels.....	41
Using the INFO button (Now & Next guide).....	43
Using the Channel Menu	43
Other Features	49

Preference Features

Setting the Time	52
Economical Solutions.....	54
Blocking Programmes	55
Other Features	56
Support Menu.....	58

Advanced Features

Application.....	60
Video Playback.....	62
Photo Playback	64
Music playback.....	66
FreeSync.....	67
Anynet+ (HDMI-CEC).....	69

Other Information

Troubleshooting.....	72
Supported Subtitle and Media Play file formats	79
Analogue Channel Teletext Feature.....	82
Attaching a Wall Mount/Desktop Stand	83
Installing the Wall Mount	85
Anti-theft Kensington Lock	86
Storage and Maintenance	87
Licence.....	88
Specifications	89
Index.....	90
Warranty Card	91
Adaptor information	93

Check the Symbol!





Note

Indicates additional information.

Getting Started

Safety Precautions

Icons used for safety precautions







	WARNING	Failing to follow the precautions marked with this sign may result in a serious injury or even a fatality.
	CAUTION	Failing to follow the precautions marked with this sign may result in a personal injury or property damage.



Do not perform.



Must be followed.

CAUTION	
RISK OF ELECTRIC SHOCK DO NOT OPEN	
CAUTION: TO REDUCE THE RISK OF ELECTRIC SHOCK, DO NOT REMOVE COVER (OR BACK). THERE ARE NO USER SERVICEABLE PARTS INSIDE. REFER ALL SERVICING TO QUALIFIED PERSONNEL.	
	This symbol indicates that high voltage is present inside. It is dangerous to make any kind of contact with any internal part of this product.
	This symbol indicates that this product has included important literature concerning operation and maintenance.
	Class II product : This symbol indicates that it does not require a safety connection to electrical earth (ground).
	AC voltage : This symbol indicates that the rated voltage marked with the symbol is AC voltage
	DC voltage : This symbol indicates that the rated voltage marked with the symbol is DC voltage.
	Caution , Consult Instructions for use : This symbol instructs the user to consult the user manual for further safety related information.

Power Related

 The following images are for your reference and may differ depending on models and countries.

Warning

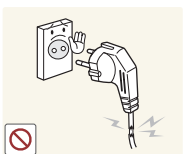

Avoid using a damaged power cord or plug or a loose power outlet.

- Otherwise, it may result in electric shock or fire.



Avoid connecting multiple electric appliances to a single wall outlet.

- Otherwise, it may result in fire due to overheating of the wall outlet.

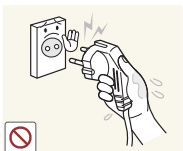

Avoid plugging in or unplugging the power supply with wet hands.

- Otherwise, it may result in electric shock.

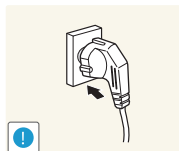

Plug the power plug in firmly.

- Otherwise, it may result in fire.

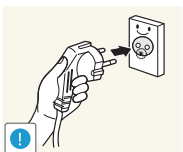

Make sure to connect the power cord to a grounded wall outlet (for insulation class 1 equipment only).

- Otherwise, it may result in electric shock or injury.

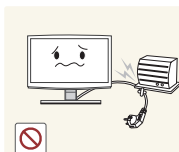

Avoid bending or twisting the power cord excessively and avoid placing heavy objects on the cord.

- Otherwise, it may result in electric shock or fire due to a damaged power cord.

Getting Started



Keep the power cord and the product away from a heater.

- Otherwise, it may result in electric shock or fire.

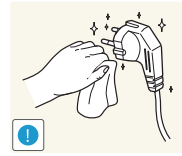

If the pins of the power plug or the wall outlet are covered in dust, clean it using a dry cloth.

- Otherwise, it may result in fire.

Caution

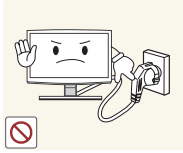

Avoid unplugging the power plug while the product is operating.

- Otherwise, it may damage the product due to electric shock.

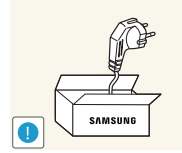

Make sure to use only the power cord supplied by our company. In addition, do not use the power cord of another electric appliance.

- Otherwise, it may result in electric shock or fire.

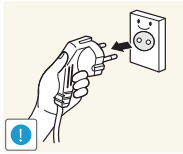

When unplugging the power plug from the wall outlet, make sure to hold it by the plug and not by the cord.

- Otherwise, it may result in electric shock or fire.

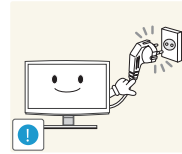

Connect the power plug to a wall outlet that can be easily reached.

- When a problem occurs with the product, you must unplug the power plug to cut the power off completely. You cannot cut the power off completely using only the power button on the product.

Installation Related

Warning



Avoid placing burning candles, mosquito coil, cigarettes on the product.

- Otherwise, it may result in fire.

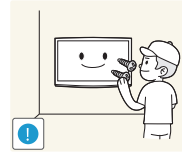

Ask an installation engineer or relevant company to install the product onto the wall.

- Otherwise, it may result in injury.
- Make sure to use the specified wall mount.



Avoid installing the product in a badly-ventilated location such as inside a bookshelf or closet.

- Otherwise, it may result in fire due to internal over-heating.

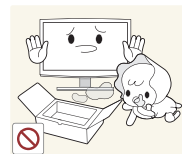

Keep the plastic bags used to pack the product away from children.

- If children place the plastic bags over their heads, they may suffocate.

Getting Started

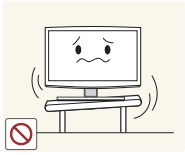

Avoid installing the product in a location that is unstable or exposed to excessive vibration such as on an unstable or slanted shelf.

- The product may fall and this may result in damage to the product or injury.
- If you use the product in a location exposed to excessive vibrations, it may result in a problem with the product or fire.



Avoid installing the product in a location exposed to dust, moisture (sauna), oil, smoke or water (rain drops) and installing it within a vehicle.

- This may result in electric shock or fire.

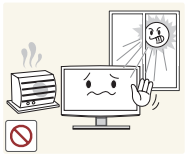

Avoid installing the product in a location exposed to direct sunlight and installing the product near a heat source such as a fireplace or heater.

- This may shorten the product life cycle or cause fire.



Avoid installing the product where children may reach it.

- If a child touches the product, the product may fall and this may result in injury.
- Since the front part is heavier, install the product on a flat and stable surface.

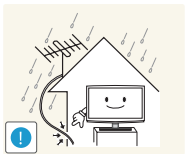

Bend the outdoor aerial cable downwards at the location where it comes in the house so that rainwater does not flow in.

- If rainwater enters the product, it may result in electric shock or fire.

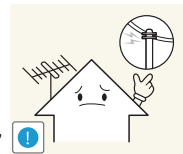

Install the aerial far away from any high voltage cables.

- If the aerial touches or falls onto a high voltage cable, it may result in electric shock or fire.

Caution



Do not let the product drop while moving it.

- This may result in a problem with the product or injury.

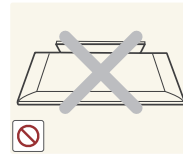

Do not place the product face down on the floor.

- This may damage the panel of the product.

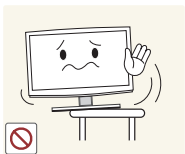

When installing the product on a console or shelf, make sure that the front of the product does not protrude out of the console or shelf.

- Otherwise, this may cause the product to fall off and result in a malfunction or injury.
- Make sure to use a cabinet or shelf suitable to the size of the product.

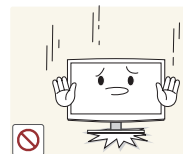

When putting the product down, handle it gently.

- Otherwise, it may result in a problem with the product or injury.

Getting Started



If the product is installed in a location where the operating conditions vary considerably, a serious quality problem may occur due to the surrounding environment. In this case, install the product only after consulting one of our service engineers about the matter.

- Places exposed to microscopic dust, chemicals, too high or low temperature, high humidity, airports or stations where the product is continuously used.

Cleaning Related

Warning

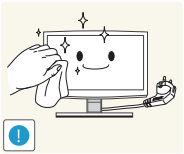

Before cleaning the product, unplug the power cord.

- Otherwise, it may result in electric shock or fire.



When cleaning the product, do not spray water directly over the product parts.

- Make sure that water does not enter the product.
- Otherwise, it may result in fire, electric shock or a problem with the product.

Caution

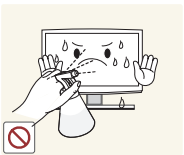

Avoid spraying cleansing agent directly onto the product.

- This may result in discolouration or cracking of the exterior of the product or the panel coming off.

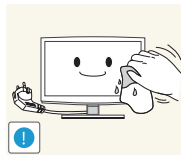

When cleaning the product, disconnect the power cord and clean the product with the cleaning cloth.

- Avoid using chemicals such as wax, benzene, alcohol, thinner, mosquito coil, fragrance, lubrication or cleansing agent when cleaning the product.
This may result in the exterior being deformed or the print being removed.

Getting Started

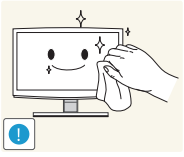

If you can't get the product clean with just the cloth, use a soft, damp cloth with a "monitor-exclusive cleansing agent" and wipe the product with it.

- If no monitor-exclusive cleansing agent is available, dilute a cleansing agent with water at a ratio of 1:10 before cleaning the product.



Since the exterior of the product is easily scratched, be sure to use the cleansing cloth.

Usage Related

Warning



Since a high voltage runs through the product, never disassemble, repair or modify the product yourself.

- Otherwise, it may result in fire or electric shock.
- If the product needs to be fixed, contact a service centre.

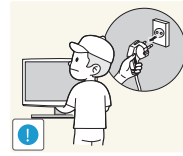

To move the product, turn the power off and unplug the power cord, the aerial cable and any other wires connected to the product.

- Otherwise, it may result in electric shock or fire due to the damaged power cord.



If the product generates a strange noise, a burning smell, or smoke, unplug the power plug immediately and contact a service centre.

- Otherwise, it may result in electric shock or fire.



Avoid letting children hang or climb onto the product.

- Otherwise, it may result in the product falling and this may result in injury or death.



If you drop the product or the case is damaged, turn the power off and unplug the power cord. Contact a service centre.

- Otherwise, it may result in fire or electric shock.

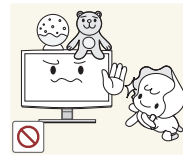

Avoid placing objects such as toys and cookies on top of the product.

- If a child hangs over the product to grab an object, the object or the product may fall and this may result in injury or even death.

Getting Started

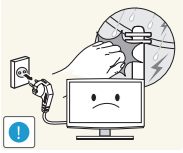

When thunder or lightning occurs, unplug the power cord and under no circumstance touch the aerial cable as this is dangerous.

- Otherwise, it may result in electric shock or fire.

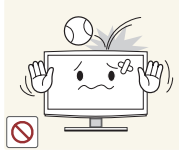

Avoid dropping an object over the product or cause impact to the product.

- Otherwise, it may result in electric shock or fire.

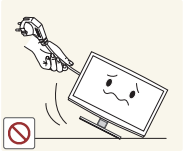

Avoid moving the product by pulling the power cord or aerial cable.

- Otherwise, it may result in electric shock, fire or a problem with the product due to damage to the cable.



When a gas leak occurs, do not touch the product or the power plug and ventilate immediately.

- A spark may result in an explosion or fire.
- During a thunder or lightning storm, do not touch the power cord or aerial cable.

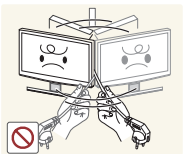

Avoid lifting up or moving the product by holding only the power cord or signal cable.

- Otherwise, it may result in electric shock, fire or a problem with the product due to damage to the cable.

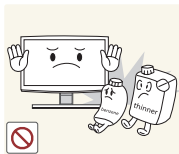

Avoid using or placing inflammable spray or objects near the product.

- This may result in an explosion or fire.



Take care not to block the vent by a table cloth or curtain.

- Otherwise, it may result in fire due to internal overheating.



Avoid inserting metal objects such as a chopsticks, coins or hairpins, or inflammable objects into the product (the vents, ports, etc).

- If water or substances enters the product, turn the power off, unplug the power cord and contact a service centre.
- Otherwise, it may result in a problem with the product, electric shock or fire.



Avoid placing a liquid container such as a vase, flowerpot, beverage, cosmetics or drugs, or a metal object over the product.

- If water or substances enter the product, turn the power off, unplug the power cord and contact a service centre.
- Otherwise, it may result in a problem with the product, electric shock or fire.



Do not press down hard on the product. The product may become deformed or damaged.

Getting Started

Caution

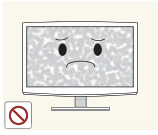

Displaying a still image for a long time may create a persistent image or stain on the screen.

- If you do not use the product for a long time, use the power-saving mode or set the screensaver to the moving picture mode.

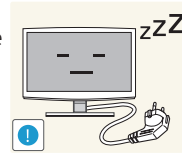

When not using the product for a long time such as leaving your home, unplug the power cord from the wall outlet.

- Otherwise, it may cause dust accumulation and result in fire caused by overheating or short circuit or result in an electric shock.



Set the appropriate resolution and frequency for the product.

- Otherwise, it may result in eye strain.

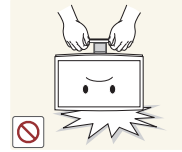

Avoid turning the product upside down or move the product holding only the stand.

- This may cause the product to fall, resulting in damage to the product or injury.

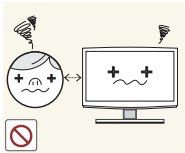

Watching the product from too close a distance continuously may damage your eyesight.



Avoid using a humidifier or cooker near the product.

- Otherwise, it may result in electric shock or fire.

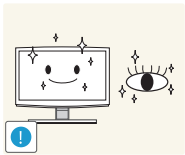

It is important to give your eyes some rest (5 minutes every hour) when viewing the product screen for long periods of time.

- This will alleviate any eye strain.



Since the display panel is hot after using it for a long time, do not touch the product.

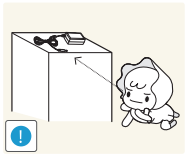

Keep the small accessories in a location out of the reach of children.

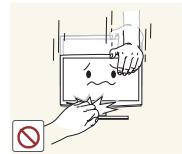

Take care when adjusting the angle of the product or the height of the stand.

- If your hand or finger is caught, you may be injured.
- If the product is tilted excessively, the product may fall and this may result in injury.

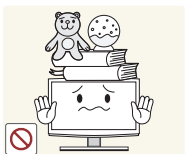

Avoid placing a heavy object over the product.

- Otherwise, it may result in a problem with the product or injury.



When using headphones or earphones, do not turn the volume too high.

- Having the sound too loud may damage your hearing.

Getting Started

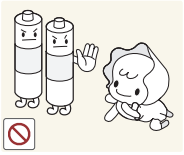

Be careful that children do not place the batteries in their mouths when removed from the remote control. Place the battery in a location that children or infants cannot reach.

- If children have had the battery in their mouths, consult your doctor immediately.

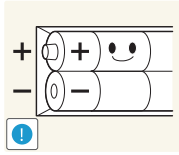

When replacing the batteries, insert them with right polarity (+, -).

- Otherwise, the battery may become damaged or it may cause fire, personal injury or damage due to leakage of the internal liquid.

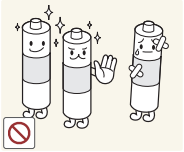

Use only specified standard batteries. Do not use new and used batteries together.

- This may cause a battery to break or leak and may cause fire, injury, or contamination (damage).

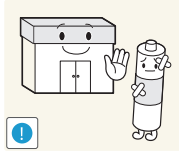

The batteries (and rechargeable batteries) are not ordinary refuse and must be returned for recycling purposes. The customer is responsible for returning the used or rechargeable batteries for recycling.

- The customer can return used or rechargeable batteries to a nearby public recycling centre or to a store selling the same type of the battery or rechargeable battery.



Do not place the adapter on top of another adapter.

- Otherwise, it may result in fire.

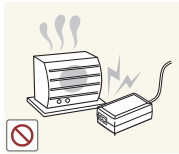

Keep power adaptor away from any other heat source.

- Otherwise, it may result in fire.

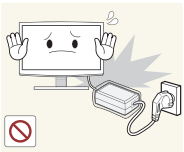

Remove the vinyl cover of the adapter before using the adaptor.

- Otherwise, it may result in fire.



Do not let water enter the DC power device or get the device wet.

- An electric shock or fire may result.
- Avoid using the product outdoors where it can be exposed to rain or snow.
- Be careful not to get the DC power adapter wet when you wash the floor.

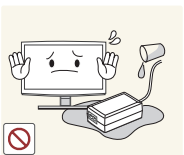

Be careful that adaptor should not be in contact with water and therefore not be wet.

- This may cause a malfunction, electric shock or fire. Do not use adaptor by the waterside or outside particularly when it rains or snows. Be careful that adaptor should not be wet while cleaning floor with water.

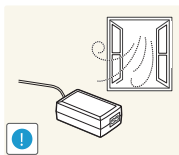

Always keep power adaptor in well-ventilated area.

Providing Proper Ventilation for Your Product

When you install your product, maintain a distance of at least 10 cm between the product and other objects (walls, cabinet sides, etc.) to ensure proper ventilation. Failing to maintain proper ventilation may result in a fire or a problem with the product caused by an increase in its internal temperature.

- ✎ Whether you install your product using a stand or a wall-mount, we strongly recommend you use parts provided by Samsung Electronics only.
 - If you use parts provided by another manufacturer, it may cause difficulties with the product or result in injury caused by the product falling.

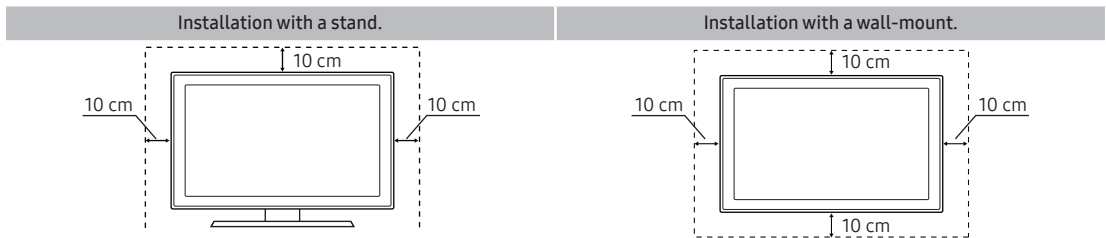

Other Warnings

- ✎ The actual appearance of the product may differ from the images in this manual, depending on the model.
- ✎ Be careful when you touch the product. Some parts can be somewhat hot.

Getting Started

Accessories and Cables

Make sure that the following items are included with your TV. If there are any items missing, contact your local dealer.

⚠ [CAUTION] INSERT SECURELY LEST SHOULD BE DETACHED IN SET

Remote Control & Batteries (AAA x 2)

Power Cord

Warranty Card / Safety Guide / Quick Setup Guide (Depending on the model) S/W Driver CD



AC/DC Adapter

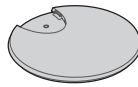

Stand Base



Stand Connector

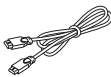

HDMI Cable

- ✎ The product colour and shape may vary depending on the model.
- ✎ Open the box and check for any accessory items hidden behind or inside the packing materials.

An administration fee may be charged in the following situations:

- An engineer is called out at your request, but there will be no defect with the product (i.e., where the user manual has not been read).
- You bring the unit to a repair centre, but there will be no defect identified the product (i.e., where the user manual has not been read).

You will be informed of the administration fee amount before a technician visits.

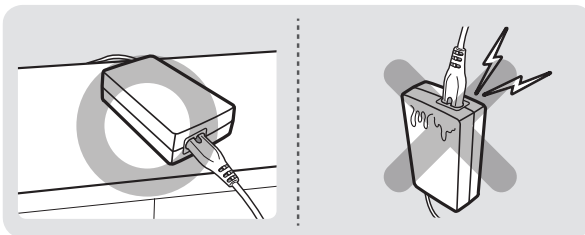

Make sure to rest the AC/DC Adapter flat on a table or the floor. If you place the AC/DC Adapter so that it is hanging with the AC cord input facing upwards, water or other foreign substances could enter the Adapter and cause the Adapter to malfunction.

Getting Started

Input Cables (Sold Separately)

You will need one or more of these cables to connect your product to your antenna or cable outlet and your peripheral devices (Blu-ray players, DVD players, etc.)



Component



Composite (AV)



Coaxial (RF)



HDMI-DVI



Stereo Cable

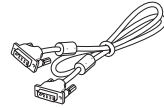

D-sub Cable

For the best cable connections to this product, use cables no thicker than the cable illustrated below:

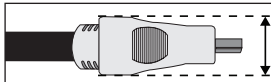

- Maximum thickness - 0.55 inches (14mm)

Getting Started



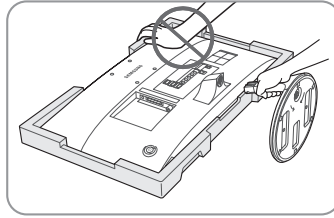
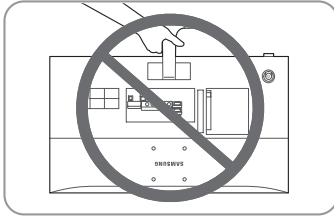
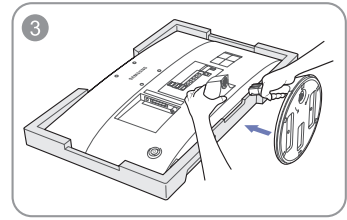
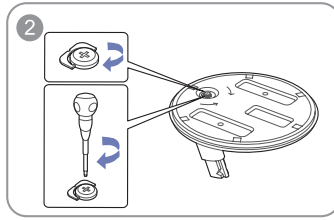
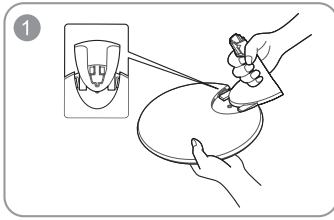

Installing the Stand

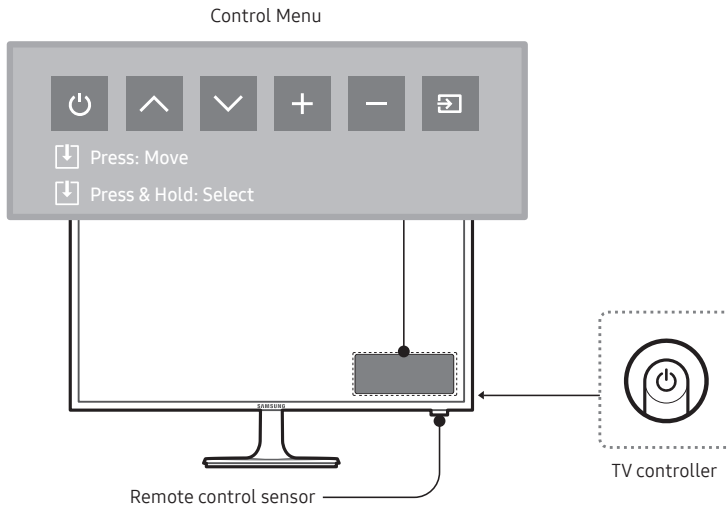

Using the Control Panel

- ✎ The product colour and shape may vary depending on the model.
- ✎ The product's Controller, like button on the rear right side of the TV, lets you control the TV without the remote control.



	Turns the TV on and off.
	Changes channels.
	Adjusts the volume.
	Displays and selects the available video sources.

- ✎ If you press it first, the control menu appears. You can select the function by pressing and holding the TV's controller.
- ✎ With the TV's Controller, you cannot perform other operations except for turning the TV on or off, changing the channel, adjusting the volume, and switching the input source.

Standby mode

Your product enters Standby mode when you turn it off and continues to consume a small amount of electric power. To be safe and to decrease power consumption, do not leave your product in standby mode for long periods of time (when you are away on vacation, for example). It is best to unplug the power cord.

Setup

The initial setup dialog appears when the TV is first activated.

Follow the on-screen instructions to finish the initial setup process, including menu language choice, country choice, channel source choice, channel scan, and more.

At each step, either make a choice or skip the step.

Users can manually perform this process at a later time under the **System** → **Setup** menu.

- ✎ The default PIN code is: 0-0-0-0.



The Standard Remote Control Buttons

- ✎ This remote control has Braille points on the Power, Channel, and Volume buttons and can be used by visually impaired persons.
- ✎ Learn where the function buttons are on your remote, such as: **SOURCE**, **^ P v**, **MENU**, **TOOLS**, **⇐**, **INFO**, **CH LIST**, **RETURN** and **EXIT**.

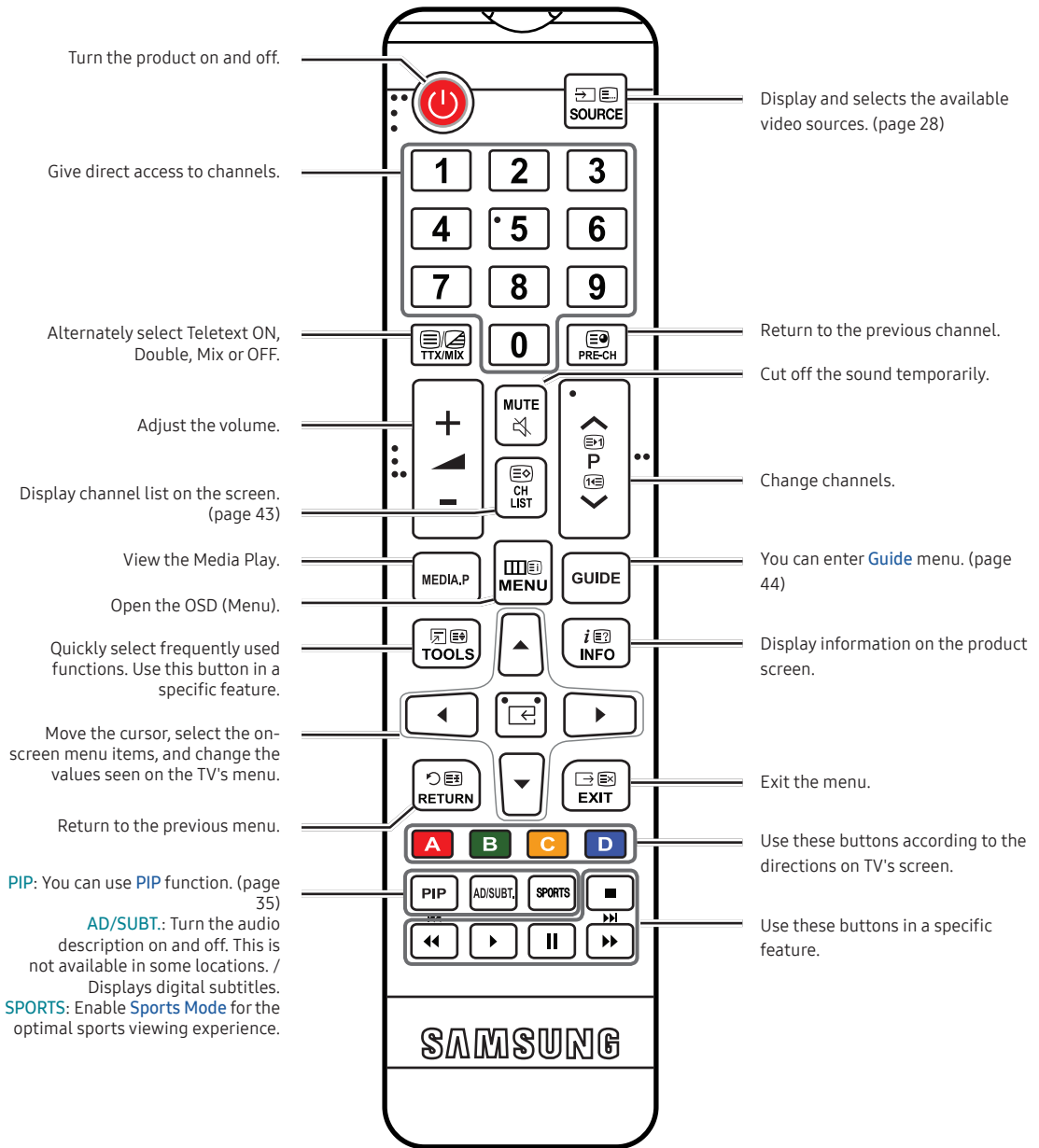

Getting Started

Installing batteries (Battery size: AAA)

Match the polarity of the batteries to the symbols in the battery compartment.

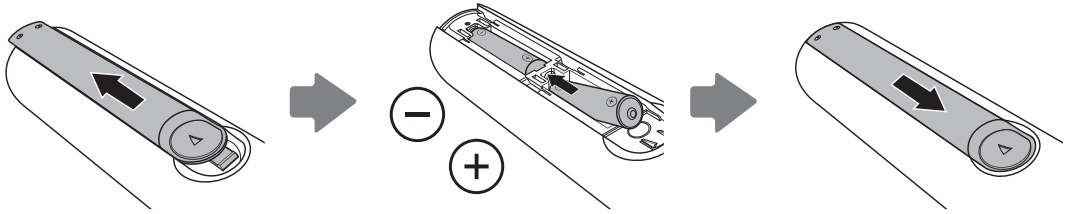

NOTE

- Install the batteries so that the polarity of the batteries (+/-) matches the illustration in the battery compartment.
- Use the remote control within 7 m of the product.
- Bright light may affect the performance of the remote control. Avoid using it near fluorescent lights or neon signs.
- The colour and shape of the remote may vary depending on the model.

How to Navigate Menus

Your product's Main and Tools menu contains functions that let you control the product's features. For example, in the Main menu you can change the size and configuration of the picture, its brightness, its contrast and so on. There are also functions that let you control the product's sound, channel configuration, energy use, and a host of other features. To access the main, on-screen menu, press the **MENU** button on your remote. To access Tools menus, press the **TOOLS** button. Tools menus are available when the **TOOLS** menu icon is displayed on the screen.

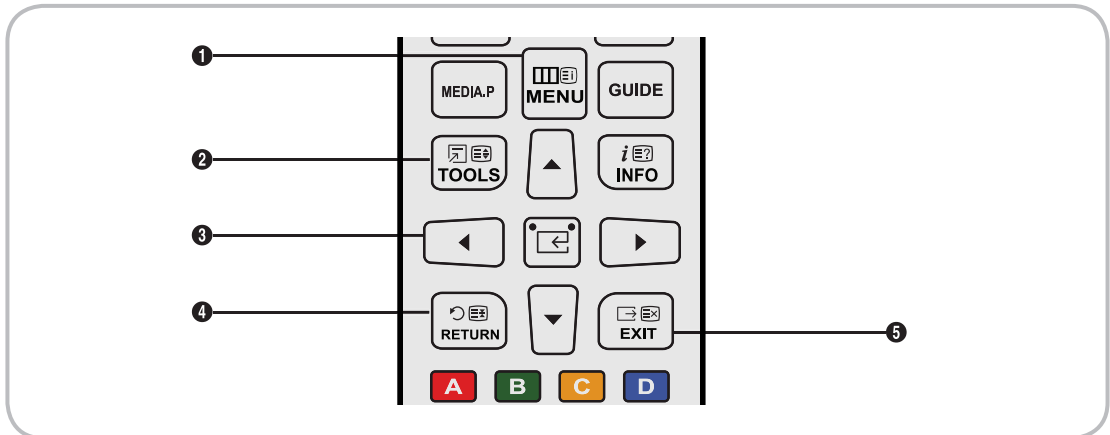

- 1 **MENU** button: Displays the main on-screen menu.
- 2 **TOOLS** button: Displays the Tools menus when available.
- 3 **←** and Direction buttons: Use the Direction buttons to move the cursor and highlight an item. Use the **↵** button to select an item or confirm the setting.
- 4 **RETURN** button: Returns to the previous menu.
- 5 **EXIT** button: Exits the on-screen menu.

How to Operate the Main Menu (OSD - On Screen Display)

The access steps may differ depending on the menu option you select.

1	MENU	The main menu options appear on the screen: Picture , Sound , Broadcasting , Applications , System , Support .
2	▲ / ▼	Select a main menu option on the left side of the screen with the ▲ or ▼ button.
3	↵	Press ↵ to access the sub-menus.
4	▲ / ▼	Select the desired sub-menu with the ▲ or ▼ button.
5	▲ / ▼ / ◀ / ▶	Adjust the value of an item with the ◀, ▶, ▲, or ▼ button. The adjustment in the OSD may differ depending on the selected menu.
6	↵	Press ↵ to confirm the selection.
7	EXIT	Press EXIT .

Connecting the Power Cord and the Aerial or Cable Connection

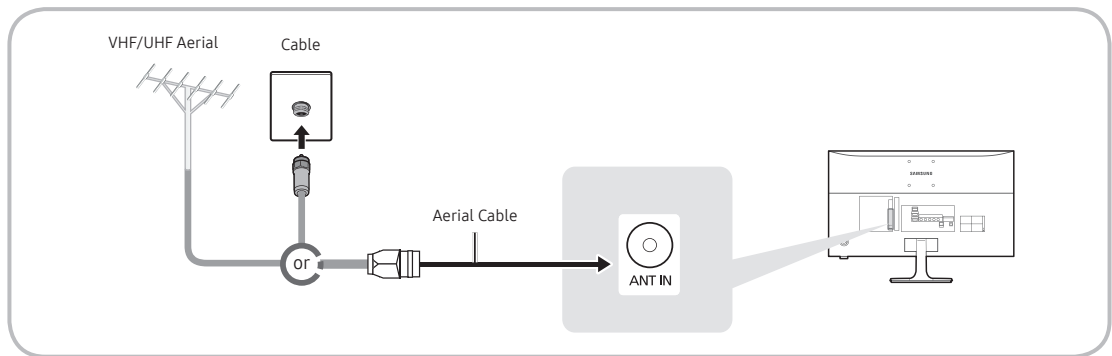

- ✎ Plug the power cord into a wall outlet only after you have made all other connections.
- ✎ If you are connecting your product to a cable or satellite box using HDMI, Component, or Composite connections, you do not need to connect the **ANT IN** jack to an aerial or a cable connection.
- ✎ Use caution when you move or swivel the product if the aerial cable is tightly connected. You could break the aerial jack off the product.

Connecting the Power

- ✎ The picture may vary depending on the model.

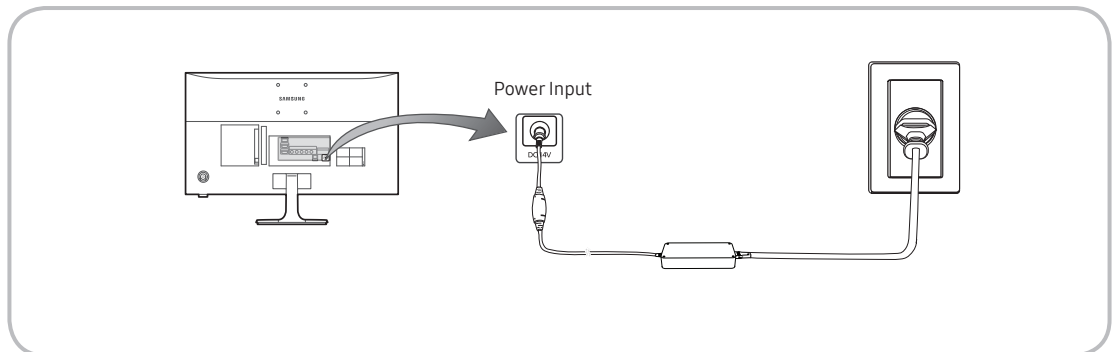

Connecting to AV Devices (Blu-ray Players, DVD Players, etc.)

Using an HDMI Cable for an HD connection (up to 1080p, HD digital signals)

For the best quality HD picture, we recommend using an HDMI connection.

Use with DVD players, Blu-ray players, HD cable boxes, and HD Set-Top-Box satellite receivers.

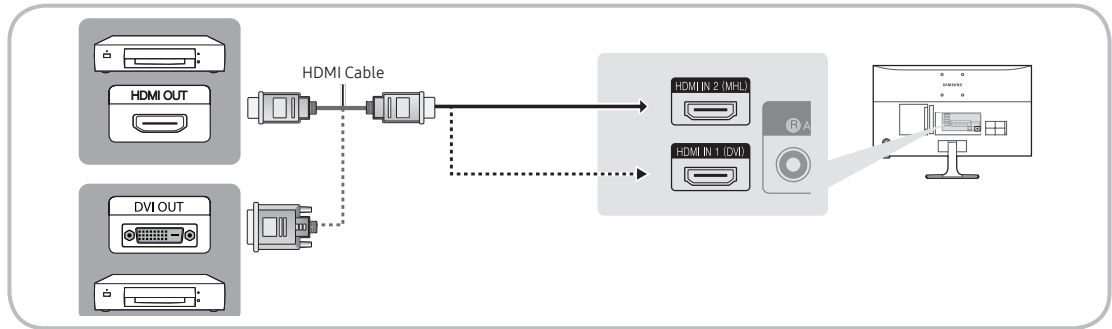

HDMI IN 1 (DVI) / HDMI IN 2 (MHL)

- For the best picture and audio quality, connect digital devices to the product using HDMI cables.
- An HDMI cable supports digital video and audio signals, and does not require an audio cable.
 - To connect the product to a digital device that does not support HDMI output, use an HDMI to DVI cable and audio cables.
- If you connect an external device to the product that uses an older version of HDMI, the video and audio may not work. If this occurs, ask the manufacturer of the device about the HDMI version and, if it is out of date, request an upgrade.
- Be sure to purchase a certified HDMI cable. Otherwise, the picture may not display or a connection error may occur.
- We recommend using a basic high-speed HDMI cable or an HDMI cable that is Ethernet compatible. Note that this product does not support the Ethernet function via HDMI.

Sharing Mobile Device Screens On the Displayer

This displayer is capable of displaying mobile device screens. You can use the following features to enjoy video, photo, and music files from mobile devices directly on your displayer.

Use an MHL cable to display a mobile device's screen on the displayer.

- MHL

This displayer supports MHL (Mobile High-definition Link) via an MHL cable. Connect an MHL cable to the mobile device and the displayer. However, MHL is only available through the **HDMI IN 2 (MHL)** port and only when used in conjunction with an MHL-enabled mobile device. This feature is only available with MHL-certified mobile devices. To find out if your mobile device is certified, visit its manufacturer's website. You can also view a list of MHL-certified devices on the official MHL website (<http://www.mhlconsortium.org>).

- MHL USE

Connect an MHL cable to the mobile device and the displayer. Press **SOURCE**  button and then select the MHL connector to display the mobile device's screen on the displayer. The following remote control functions will also be available:

- , , , , , 

- Restrictions

MHL has several requirements:

- If you are using an HDMI adapter, the displayer recognises the signal as an HDMI signal and may respond differently than it would to an MHL-to-HDMI cable connection.
- Upgrade the software to the latest version.
- This product is officially MHL-certified. If users encounter any problem when using the MHL function, they must contact the manufacturer of the device.
- Some mobile devices may not have sufficient specifications or features to support MHL.
- Because the displayer screen is wider than most mobile device screens, the picture quality may appear lower on the displayer.

Connections

Using a Component Cable (up to 1080p HD signals) or an Audio/Video Cable (480i analogue signals only)

Use with DVD players, Blu-ray players, cable boxes, STB satellite receivers, VCRs.

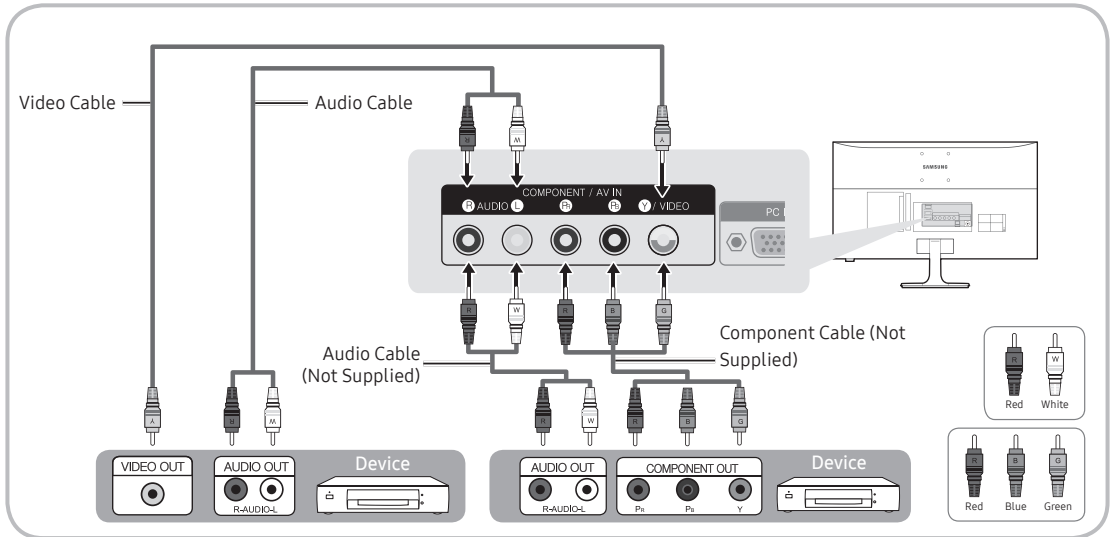

- ✎ For better picture quality, we recommend the Component connection over the A/V connection.
- ✎ When you connect a Video cable to **COMPONENT / AV IN**, the colour of the **COMPONENT / AV IN [VIDEO]** jack (green) will not match the video cable (yellow).

Connecting to Audio Devices

Using a Headphone Cable Connection

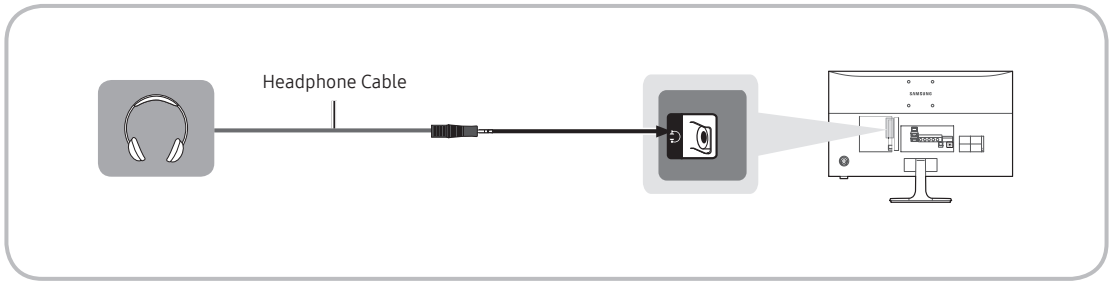

- Headphones** 🎧: You can connect your headphones to the headphone output jack on your product. While the headphones are connected, the sound from the built-in speakers will be disabled.
- The sound function may be restricted when you connect headphones to the product.
 - Headphone volume and product volume are adjusted separately.
 - The earphone jack supports only the 3 conductor tip-ring-sleeve (TRS) type.

Connecting to a PC

Using an HDMI Cable or an HDMI to DVI Cable or a D-sub Cable Connection

- ✎ Your PC may not support an HDMI connection.
- ✎ Use your PC speakers for audio.

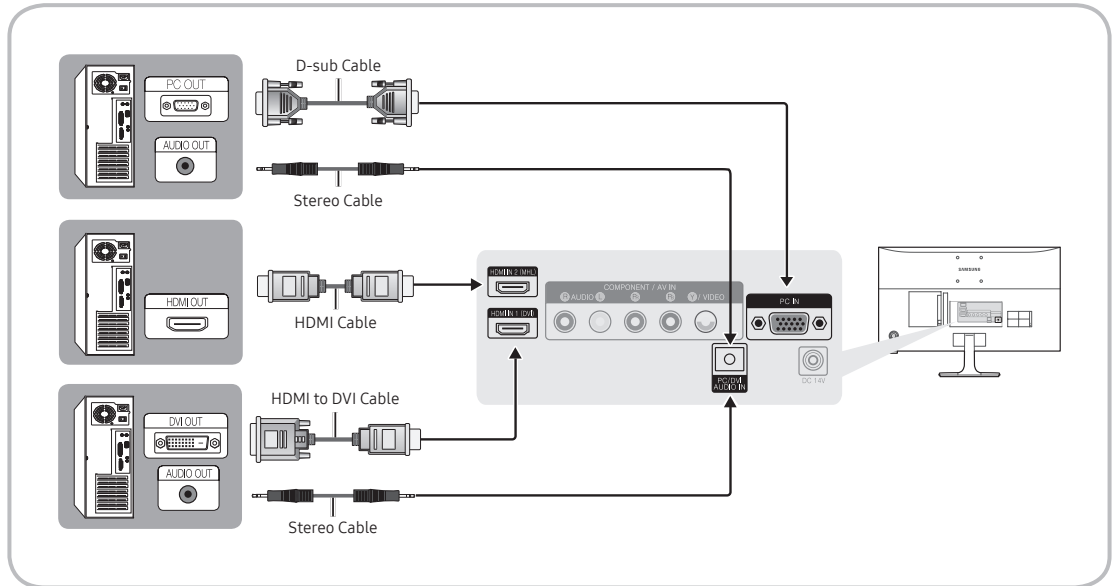

✎ **NOTE**

- For an HDMI to DVI cable connection, you must use the **HDMI IN 1 (DVI)** jack.
- For PC's with DVI video out jacks, use an HDMI to DVI cable to connect the DVI out on the PC to the **HDMI IN 1 (DVI)** jack on the product. Use the PC's speakers for audio.

Connecting to a COMMON INTERFACE slot (Your product viewing Card Slot)

Using the “CI or CI+ CARD”

To watch paid channels, the “CI or CI+ CARD” must be inserted.

- If you don't insert the “CI or CI+ CARD”, some channels will display the message “Scrambled Signal”.
- The pairing information containing a telephone number, the “CI or CI+ CARD” ID the Host ID and other information will be displayed in about 2~3 minutes. If an error message is displayed, please contact your service provider.
- When the configuration of channel information has finished, the message “Updating Completed” is displayed, indicating the channel list is updated.

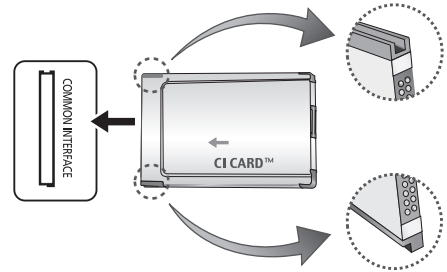

NOTE

- You must obtain a “CI or CI+ CARD” from a local cable service provider.
- When removing the “CI or CI+ CARD”, carefully pull it out with your hands since dropping the “CI or CI+ CARD” may cause damage to it.
- Insert the “CI or CI+ CARD” in the direction marked on the card.
- The location of the **COMMON INTERFACE** slot may be different depending on the model.
- “CI or CI+ CARD” is not supported in some countries and regions; check with your authorised dealer.
- If you have any problems, please contact a service provider.
- Insert the “CI or CI+ CARD” that supports the current aerial settings. The screen will be distorted or will not be seen.

Connections

Display Modes (D-Sub and HDMI/DVI Input)

The optimal PC display resolution for this product is 1920 x 1080 @ 60 Hz. We very strongly recommend you set the video output of your computer to the optimal resolution. You can also select one of the standard resolutions listed in the table below and the product will be automatically adjust to the resolution you choose. If you set your computer's video output to a resolution not listed in the table, the product screen may go blank and only the power indicator will turn on. To resolve this issue, adjust the resolution according to the following table, referring to the user guide for the graphics card.

- Optimal resolution: 1920 x 1080 pixels

Display Mode			Horizontal Frequency (KHz)	Vertical Frequency (Hz)	Pixel Clock (MHz)	Sync Polarity (H / V)
Mode	Resolution					
IBM	720 x 400	70Hz	31.469	70.087	28.322	-/+
VESA DMT	640 x 480	60Hz	31.469	59.940	25.175	-/-
MAC	640 x 480	67Hz	35.000	66.667	30.240	-/-
VESA DMT	640 x 480	72Hz	37.861	72.809	31.500	-/-
VESA DMT	640 x 480	75Hz	37.500	75.000	31.500	-/-
VESA DMT	800 x 600	60Hz	37.879	60.317	40.000	+/+
VESA DMT	800 x 600	72Hz	48.077	72.188	50.000	+/+
VESA DMT	800 x 600	75Hz	46.875	75.000	49.500	+/+
MAC	832 x 624	75Hz	49.726	74.551	57.284	-/-
VESA DMT	1024 x 768	60Hz	48.363	60.004	65.000	-/-
VESA DMT	1024 x 768	70Hz	56.476	70.069	75.000	-/-
VESA DMT	1024 x 768	75Hz	60.023	75.029	78.750	+/+
VESA DMT	1152 x 864	75Hz	67.500	75.000	108.000	+/+
MAC	1152 x 870	75Hz	68.681	75.062	100.000	-/-
VESA DMT	1280 x 720	60Hz	45.000	60.000	74.250	+/+
VESA DMT	1280 x 800	60Hz	49.702	59.810	83.500	-/+
VESA DMT	1280 x 1024	60Hz	63.981	60.020	108.000	+/+
VESA DMT	1280 x 1024	75Hz	79.976	75.025	135.000	+/+
VESA DMT	1366 x 768	60Hz	47.712	59.790	85.500	+/+
VESA DMT	1440 x 900	60Hz	55.935	59.887	106.500	-/+
VESA DMT	1600 x 900RB	60Hz	60.000	60.000	108.000	+/+
VESA DMT	1680 x 1050	60Hz	65.290	59.954	146.250	-/+
VESA DMT	1920 x 1080	60Hz	67.500	60.000	148.500	+/+





- ✎ For an HDMI to DVI cable connection, you must use the **HDMI IN 1 (DVI)** jack.
- ✎ The interlace mode is not supported.
- ✎ The set may operate abnormally if you select a non-standard video format.
- ✎ Separate and Composite modes are supported. SOG(Sync On Green) is not supported.
- ✎ DPM(Display Power Management) Function does not work if you used in connection with the HDMI port of this product.
- ✎ If an HDMI to DVI cable is connected to the **HDMI IN 1 (DVI)** port, the audio does not work.

Changing the Input Source

Source

When you are watching product and you want to watch a movie on your DVD player or Blu-ray player or switch to your cable box or STB satellite receiver, you need to change the Source.

TV / PC / HDMI1/DVI / HDMI2 / AV / Component

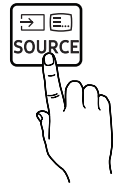

1. Press the **SOURCE**  button on your remote. The **Source** screen appears.
2. Select a desired external input source.
 -  Use to select TV or other external input sources such as DVD / Blu-ray players / cable box / STB satellite receiver connected to the TV.
 -  You can only choose external devices that are connected to the product. In the displayed **Source** list, connected inputs are highlighted.
 -  In the **Source**, **TV** and **PC** are always stays activated.



How to Use Edit Name

Edit Name lets you associate a device name to an input source. To access **Edit Name**, open the **Tools** menu when the **Source** list is displayed. The following selections appear under **Edit Name**:

VCR / DVD / Cable STB / Satellite STB / PVR STB / AV Receiver / Game / Camcorder / PC / DVI PC / DVI Devices / TV / IPTV / Blu-ray / HD DVD / DMA: Select an input jack, and then select the name of the device connected to that jack from the list that appears.

-  If you connect a PC to the **HDMI IN 1 (DVI)** port with an HDMI cable, assign **PC** to **HDMI1/DVI** in **Edit Name**.
-  If you connect a PC to the **HDMI IN 1 (DVI)** port with an HDMI to DVI cable, assign **DVI PC** to **HDMI1/DVI** in **Edit Name**.
-  If you connect an AV device to the **HDMI IN 1 (DVI)** port with an HDMI to DVI cable, assign **DVI Devices** to **HDMI1/DVI** in **Edit Name**.

Information

You can see detailed information about the channel on TV or the selected external device.

Refresh

If the external devices are not displayed in the **Source** list, open the **Tools** menu, and then select **Refresh**, and then search for the connected devices.

Correct posture to use the product



Use the product in the correct posture as follows.

- Straighten your back.
- Adjust the angle so light does not reflect on the screen.
- Keep your forearms perpendicular to your upper arms and level with the back of your hands.
- Keep your elbows at about a right angle.
- Adjust the height of the product so you can keep your knees bent at 90 degrees or more, your heels attached to the floor, and your arms lower than your heart.

Changing the Preset Picture Mode

Picture Mode

[MENU](#) → [Picture](#) → [Picture Mode](#)

Picture modes apply preset adjustments to the picture.

- **Dynamic**
Suitable for a bright room.
- **Standard**
Suitable for a normal environment.
- **Movie**
Suitable for watching movies in a dark room.
- **Entertain**
Sharpens the picture. Suitable for games.
 It is only available when connecting a PC.

Adjusting Picture Settings

Backlight

MENU → Picture → Backlight

Adjusts the brightness of the screen by adjusting the brightness of the individual pixels.

Contrast

MENU → Picture → Contrast

Increases or decreases the contrast between dark and light areas of the picture.

Brightness

MENU → Picture → Brightness

Adjusts the brightness of the screen. Not as effective as **Backlight**.

Sharpness

MENU → Picture → Sharpness

Sharpens or dulls the edges of objects.

Colour

MENU → Picture → Colour

Adjust colour saturation levels.

Tint (G/R)

MENU → Picture → Tint (G/R)

Adjust tint levels for green and red.

To adjust picture quality, follow these steps:

1. Select an option you want to adjust. When you select an option, a slider screen appears.
 2. Adjust the option value using your remote.
- ✎ When you make change to option value, the OSD will be adjusted accordingly.
 - ✎ You can adjust and store Settings for each external device connected to the product.
 - ✎ Lowering picture brightness reduces power consumption.

Response Time (Normal / Faster / Fastest)

Accelerate the panel response rate to make video appear more vivid and nature.

Changing the Picture Size

Picture Size

MENU → Picture → Picture Size

Using this function, you can make change to various picture size and aspect ratio options.

Picture Size

If you have a cable box or satellite receiver, it may have its own set of screen sizes as well. However, we highly recommend you use your products **16:9** mode most of the time.

- **Auto Wide:** Automatically adjusts the picture size to the 16:9 aspect ratio.
- **16:9:** Sets the picture to the 16:9 wide screen format.
- **Wide Zoom:** Magnifies the picture size more than **4:3**.
 - ✎ Adjusts the **Position** by using ▲ / ▼ buttons.
- **Zoom :** Magnifies the 16:9 wide pictures vertically to fit the screen size.
 - ✎ Adjusts the **Zoom** or **Position** by using ▲ / ▼ button.
- **4:3:** Sets the picture to basic (4:3) mode.
 - ✎ Do not set your product to 4:3 format for a long time. The borders displayed on the left and right, or top and bottom of the screen may cause image retention (screen burn) which is not covered by the warranty.
- **Screen Fit:** Displays the full image without any cut-off when HDMI (720p / 1080i / 1080p) or Component (1080i / 1080p) signals are inputted.
 - ✎ Adjusts the **Position** by using ▲ / ▼ / ◀ / ▶ button.
- **Custom:** Magnifies or shrinks 16:9 pictures vertically and/or horizontally. A magnified or shrunk picture can be moved left, right, up, and down.
 - ✎ Depending on the input source, the picture size options may vary.
 - ✎ The available items may differ depending on the selected mode.
 - ✎ When connecting a PC, only **16:9** and **4:3** modes can be adjusted.
 - ✎ Settings can be adjusted and stored for each external device connected to an input on the product.
 - ✎ If you use the **Screen Fit** function with HDMI 720p input, 1 line will be cut at the top, bottom, left and right as in the overscan function.
- **Zoom/Position:** You can adjust picture size and position by ▲ / ▼ / ◀ / ▶ button.
 - ✎ It's only available when picture size is set as **Zoom**, **Wide Zoom**, **Screen Fit** and **Custom**.
 - ✎ In **Wide Zoom** and **Screen Fit** mode, you can only use Position adjustment.
 - ✎ **Reset:** Reset the **Zoom** and **Position** to the default settings.

Basic Features

To use the Position function after selecting **Wide Zoom**, **Zoom** or **Screen Fit**, follow these steps:

1. Select the **Position**.
2. On the **Position** screen, select **Position**, and then move the picture to position you want using your remote.
3. When done, select **Position** again, and then select **Close**.
4. To reset the picture position, select **Reset**.

Picture Sizes available by Input Source:

- ATV, AV: **Auto Wide**, **16:9**, **Wide Zoom**, **Zoom**, **4:3**, **Custom**
- DTV (576i/p, 720p): **Auto Wide**, **16:9**, **Wide Zoom**, **Zoom**, **4:3**, **Custom**
- DTV (1080i, 1080p): **Auto Wide**, **16:9**, **Wide Zoom**, **Zoom**, **4:3**, **Screen Fit**, **Custom**
- Component (480i/p, 576i/p, 720p): **16:9**, **Wide Zoom**, **Zoom**, **4:3**, **Custom**
- Component (1080i, 1080p): **16:9**, **Wide Zoom**, **Zoom**, **4:3**, **Screen Fit**, **Custom**
- HDMI (480i/p, 576i/p): **16:9**, **Wide Zoom**, **Zoom**, **4:3**, **Custom**
- HDMI (720p, 1080i, 1080p): **16:9**, **Wide Zoom**, **Zoom**, **4:3**, **Screen Fit**, **Custom**
- ✎ Depending on the input source, the picture size options may vary.
- ✎ The available items may differ depending on the selected mode.
- ✎ HD (High Definition): 16:9 - 1080i/1080p (1920x1080), 720p (1280x720)
- ✎ You can adjust and store settings for each external device you have connected to an input on the product.
- **4:3 Screen Size (16:9 / Wide Zoom / Zoom / 4:3)**

Available only when picture size is set to **Auto Wide**. You can determine the desired picture size at the 4:3 WSS (Wide Screen Service) size or the original size. Each European country requires different picture size.

 - ✎ Not available in **HDMI**, **Component**, and **HDMI/DVI** mode.

Calibrating the Screen Display

Auto Adjustment

MENU → Picture → Auto Adjustment

Automatically adjusts the picture's frequency, position, and fine tune settings in the PC mode.

 Available only when you connect your PC to the product with a D-Sub cable.

PC Screen Adjustment

MENU → Picture → PC Screen Adjustment

 Available in PC mode only.

- **Coarse / Fine:** Removes or reduces picture noise. If the noise is not removed by Fine-tuning alone, use the **Coarse** function to adjust the frequency as best as possible (**Coarse**) and Fine-tune again. After the noise has been reduced, re-adjust the picture so that it is aligned with the centre of screen.
- **Position:** Adjust the PC's screen position using your remote if it is not centre or does not fit the product screen.
- **Image Reset:** Resets the image to the default settings.

Using Your Product as a Computer (PC) Display

Entering the Video Settings (Based on Windows 7, 8, 10)

For your product to work properly as a computer display, you must enter the correct video settings.

 Depending on your version of Windows and your video card, the procedure on your PC will probably differ slightly from the procedure presented here.

 However, the same basic information will apply in most cases. (If not, contact your computer manufacturer or Samsung Dealer.)











1. Click "Control Panel" on the Windows start menu.
2. Click "Appearance and Themes" in the "Control Panel" window. A display dialog box appears.
3. Click "Display". Another display dialog box appears.
4. Click the "Settings" tab on the display dialog box.
 - On the Settings tab, set the correct resolution (screen size). The optimal resolution for this product is 1920 x 1080.
 - If a vertical-frequency option exists on your display settings dialog box, select "60" or "60 Hz". Otherwise, just click "OK" and exit the dialog box.

Picture In Picture (PIP)

PIP

MENU → Picture → PIP

View two sources on the TV at the same time.

- **PIP**
Activate or deactivate the **PIP** function.
 - **Source**
Changes the source.
 - **Aerial**
Choose between **Terrestrial** or **Cable**.
 - **Channel**
Select the channel for the sub-picture screen.
 - **Size** ( /  / )
The sub-picture size can be set by three modes.
 - **Position** ( /  /  / )
Select a position for the sub-picture screen.
 - **Sound Select**
You can choose to listen to the sound from the main picture or the sub picture.
-  If you turn the product off while watching in the **PIP** mode, the **PIP** function is reset to **Off**. When you turn your product on, you must turn **PIP** on again to watch in the **PIP** mode.
-  You may notice that the picture in the **PIP** screen becomes slightly unnatural when you use the main screen to view a game or karaoke.
-  **PIP** Settings
- Main picture: TV, PC, AV, Component, HDMI1/DVI, HDMI2
 - Sub picture: TV, PC, AV, Component, HDMI1/DVI, HDMI2

		main screen					
		TV	AV	Component	PC	HDMI1/DVI	HDMI2
sub picture	TV	X	X	O	O	O	O
	AV	X	X	X	O	O	O
	Component	O	X	X	X	O	O
	PC	O	O	X	X	O	O
	HDMI1/DVI	O	O	O	O	X	X
	HDMI2	O	O	O	O	X	X

 O: Available / X: Not Available

Changing the Picture Options

Advanced Settings

MENU → Picture → Advanced Settings

Using this function, you can configure advanced picture settings to create your preferred picture.

 Available when the **Picture Mode** is set to **Standard** or **Movie**.

 When connecting a PC, you can make changes to the **White Balance** or **Gamma**.

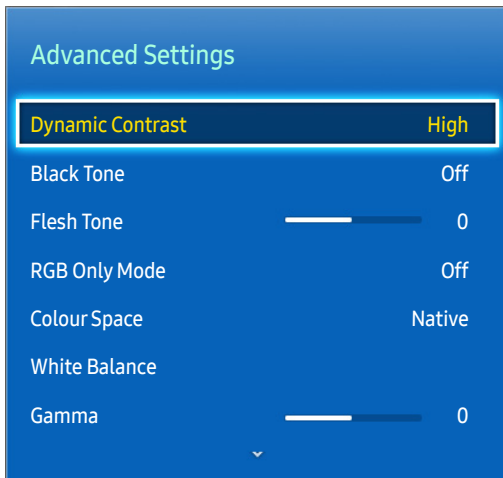

- **Dynamic Contrast** (Off / Low / Medium / High): Adjust the screen contrast.
- **Black Tone** (Off / Dark / Darker / Darkest): Select the black level to adjust the screen depth.
- **Flesh Tone**: Emphasise pink “Flesh Tone.”
- **RGB Only Mode** (Off / Red / Green / Blue): Displays the **Red**, **Green** and **Blue** colour for making fine adjustments to the hue and saturation.
- **Colour Space** (Auto / Native): Adjust the range of colours available to create the image.
- **White Balance**: Adjusts the Colour temperature of the picture so that white objects look white (instead of, for example, slightly pink or slightly yellow) and the overall Colour of the picture looks natural.
R-Offset / **G-Offset** / **B-Offset**: Adjusts each Colour’s (red, green, blue) darkness.
R-Gain / **G-Gain** / **B-Gain**: Adjusts each Colour’s (red, green, blue) brightness.
Reset: Resets the **White Balance** to its default settings.
- **Gamma**: Adjust the primary colour intensity.
- **Motion Lighting** (Off / On): Reduce power consumption by brightness control.

Basic Features

Picture Options

MENU → Picture → Picture Options

Using this function, you can configure additional picture settings to suit your preference.

✎ When connecting a PC, you can only make changes to **Colour Tone**.

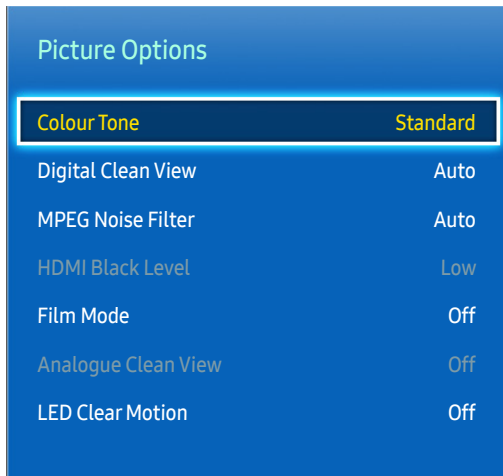

Picture Options	
Colour Tone	Standard
Digital Clean View	Auto
MPEG Noise Filter	Auto
HDMI Black Level	Low
Film Mode	Off
Analogue Clean View	Off
LED Clear Motion	Off

- **Colour Tone (Cool / Standard / Warm1 / Warm2)**
 - ✎ **Warm1** or **Warm2** will be deactivated when the picture mode is **Dynamic**.
 - ✎ Settings can be adjusted and stored for each external device connected to an input on the product.
- **Digital Clean View (Off / Low / Medium / High / Auto / Auto Visualisation)**: If the broadcast signal received by your product is weak, you can activate the **Digital Clean View** feature to reduce any static and ghosting that may appear on the screen.
 - ✎ When the signal is weak, try other options until the best picture is displayed.
 - Auto Visualisation**: When changing analogue channels, displays signal strength.
 - ✎ This function is available for analogue channels only.
 - ✎ When bar is green, you are receiving the best possible signal.
- **MPEG Noise Filter (Off / Low / Medium / High / Auto)**: Reduces MPEG noise to provide improved picture quality.
- **HDMI Black Level (Low / Normal)**: Selects the black level on the screen to adjust the screen depth.
 - ✎ Available only in **HDMI** mode (RGB signals).
- **Film Mode (Off / Auto1 / Auto2)**: Sets the product to automatically sense and process film signals from all sources and adjust the picture for optimum quality.
 - ✎ Available in **TV** mode, HDMI (1080i).
 - ✎ If the screen does not seem natural, change its option to **Off / Auto1 / Auto2** in **Film Mode**.
- **Analogue Clean View**: Reduces noise in the form of a diagonal line that occurs due to interferences between signals.
 - ✎ This function is available for analogue channels only.
- **LED Clear Motion**: Removes drag from fast scenes with a lot of movement to provide a clear picture.
 - ✎ The screen may become slightly darker when you play **LED Clear Motion**.

Basic Features

Picture Off

[MENU](#) → [Picture](#) → [Picture Off](#)

Turns off the screen and plays audio only. To turn the screen back on, press any button (except Power and Volume buttons) on your remote.

Reset Picture

[MENU](#) → [Picture](#) → [Reset Picture](#)

Resets your current picture mode to its default settings.

Changing the Preset Sound Mode

Sound Mode

[MENU](#) → [Sound](#) → [Sound Mode](#)

Sound modes apply preset adjustments to the sound.

- **Standard**
Selects the normal sound mode.
- **Music**
Emphasises music over voices.
- **Movie**
Provides the best sound for movies.
- **ClearVoice**
Emphasises voices over other sounds.
- **Amplify**
Increase the intensity of high-frequency sound to allow a better listening experience for the hearing impaired.

Adjusting Sound Settings

Sound Effect

MENU → **Sound** → **Sound Effect**

 Available only when the **Sound Mode** is set to **Standard**.

- **Equaliser**

The **Equaliser** displays a series of sliders. Use the arrow buttons to select a slider, and change the slider's value. To **Reset** the **Equaliser**, select the **Reset**. A pop-up appears asking if you want to reset, select **Yes**, otherwise select **No**. To exit, select **Close**.

Balance L/R: Adjusts the balance between the right and left speaker.

100Hz / 300Hz / 1kHz / 3kHz / 10kHz (Bandwidth Adjustment): Adjusts the loudness of specific bandwidth frequencies.

Reset: Resets the equaliser to its default settings.

Basic Features

Speaker Settings

MENU → Sound → Speaker Settings

- **Auto Volume**

Because each station has its own broadcasting conditions, the volume may fluctuate each time you change the channel. This feature automatically adjusts the volume of a channel by lowering the sound output when the modulation signal is high or by raising the sound output when the modulation signal is low.

 To use the volume control of a connected source device, set **Auto Volume** to **Off**. A change to the volume control of the connected source device may not be applied if **Auto Volume** is set to **Normal** or **Night**.

- **TV Installation Type**

Specify the TV's installation type. Choose between **Wall Mount** and **Stand** to optimise the TV's sound automatically.

Additional Settings

(digital channels only)

- **DTV Audio Level (MPEG / HE-AAC)**: This function allows you to reduce the disparity of a voice signal (which is one of the signals received during a digital TV broadcast) to a desired level.

 According to the type of broadcast signal, **MPEG / HE-AAC** can be adjusted between -10dB and 0dB.

 To increase or decrease the volume, adjust between the range 0 and -10 respectively.

- **HDMI Audio Format (PCM / Bitstream)**: Sets the audio input signal format suitable for the external device connected to the TV's HDMI port.

- **Dolby Digital Comp (Line / RF)**: This function minimises signal disparity between a dolby digital signal and a voice signal (i.e. MPEG Audio, **HE-AAC**, ATV Sound).

 Select **Line** to obtain dynamic sound, and **RF** to reduce the difference between loud and soft sounds at night time.

Line: Set the output level for signals greater or less than -31dB (reference) to either -20dB or -31dB.

RF: Set the output level for signals greater or less than -20dB (reference) to either -10dB or -20dB.

Reset Sound

MENU → Sound → Reset Sound

Reset all sound settings to the factory defaults.

Selecting the Sound Mode

When you set to **Dual I II**, the current sound mode is displayed on the screen.

	Audio Type	Dual I-II	Default
A2 Stereo	Mono	Mono	Automatic change
	Stereo	Stereo ↔ Mono	
	Dual	Dual I ↔ Dual II	Dual I
NICAM Stereo	Mono	Mono	Automatic change
	Stereo	Mono ↔ Stereo	
	Dual	Mono ↔ Dual I ↖ Dual II ↙	Dual I

 If the Stereo signal is weak and an automatic switching, occurs, then switch to the Mono.

 Only activated in stereo sound signal.

 Only available when the input Source is set to TV.

Memorising Channels

Aerial

MENU → **Broadcasting** → **Aerial**

Before your product can memorise the available channels, you must select your Product signal source, **Terrestrial** (using an aerial) or **Cable**. Select **Terrestrial** or **Cable**. After you have selected the signal source, go on to the **Auto Tuning** function.

 Selecting the signal source using the **Aerial** function also determines the signal source the product is tuned to. For example, if you receive your product signal over the aerial, and you select **Cable**, you will see only snow. You must select **Terrestrial** to see a picture.

Auto Tuning

MENU → **Broadcasting** → **Auto Tuning**

Automatically scans and indexes all channels received through the TV's aerial input connector.

To start, navigate to **Broadcasting** and select **Auto Tuning**.

Select **Start** when prompted with a message. This initiates the **Auto Tuning** function. The process can take up to 30 minutes to complete. If Starting the **Auto Tuning** function when there is an existing index of channels overwrites the previous index.

- **Auto Tuning**
Scans for channels automatically and stores them in the TV's memory.
- **Cable Search Option** (when the aerial was set to Cable) (Depending on the country)
Sets additional search options such as the frequency and symbol rate for a cable network search.
- **Standby Auto Tuning**
Auto-tune channels while your TV is in standby mode.
 This function is not available on certain models in specific geographical areas.
- **Wake-up Timer**
Schedule timer to turn the TV on and scan channels automatically.

Country (Area)

MENU → **Broadcasting** → **Channel Settings** → **Country (Area)**

Select your country so that the product can correctly auto-tune the broadcasting channels.

 The PIN input screen appears. Enter your 4 digit PIN number.

- **Digital Channel**: Change the country for digital channels.
- **Analogue Channel**: Change the country for analogue channels.

Basic Features

Manual Tuning

MENU → **Broadcasting** → **Channel Settings** → **Manual Tuning**

Scans for a channel manually and stores in the TV.

- ✎ If a channel is locked using the **Channel Lock** function, the PIN input window appears.
- ✎ This function is only available in specific geographical areas.

- **Digital Channel Tuning**

Scans for a digital channel.

1. Select the **New**.

- ✎ When selecting **Aerial** → **Terrestrial**
Channel, Frequency, Bandwidth

- ✎ When selecting **Aerial** → **Cable**
Frequency, Modulation, Symbol Rate

2. Select the **Search**. When scanning has finished, a channel is updated in the channel list.

- **Analogue Channel Tuning**

Scans for an analogue channel.

1. Select the **New**.
2. Set the **Programme, Colour System, Sound System, Channel** and **Search**.
3. Select the **Store**. When scanning has finished, a channel is updated in the channel list.

Channel mode

- **P** (programme mode)

When tuning is complete, the broadcasting stations in your area have been assigned to position numbers from P0 to P99. You can select a channel by entering the position number in this mode.





- **C** (aerial channel mode) / **S** (cable channel mode)

These two modes allow you to select a channel by entering the assigned number for each aerial broadcasting station or cable channel.

Using the INFO button (Now & Next guide)

The display identifies the current channel and the status of certain audio-video settings.

The Now & Next guide shows daily TV programme information for each channel according to the broadcasting time.

- Scroll ,  to view information for a desired programme while watching the current channel.
- Scroll ,  to view information for other channels. If you want to move to the currently selected channel, select  using your remote.



Using the Channel Menu

Channel List

MENU → **Broadcasting** → **Channel List**

Press **CH LIST** button while viewing TV to display a list you can use to jump between channels. The list also displays the programme info, favourites channels, and the Schedule Viewing and Schedule Recording programmes.

The **Channel List** screen icons indicate the following:

-  : An analogue channel
-  : A favourites channel
-  : A locked channel

Change Channels

Select a channel to jump to it right away. To quickly scroll through the list, use the channel up/down buttons. The focus moves up and down the list in one page.

Sorting

(digital channels only)

On the Channel list screen, press  button, you can use sorting function.

Change the list ordered by name or number.

Basic Features

Change the Broadcast Signal

Press **▶** button on the remote and select a broadcasting signal. This will change the signal source immediately.

Change the Channel List

Press **▶** button on the remote and switch to the Favourites list. However, the Favourites list can only be selected if it contains at least one favourites channel. If no favourites channel was previously added, select **Edit Favourites** and add channels from the **Edit Favourites** screen.

You can also change the antenna to **Terrestrial** or **Cable**.

You can choose your channel source from **All, TV**, or **Analogue**.

Guide

MENU → **Broadcasting** → **Guide**

View each digital channel's programming schedule, including showtimes. Check the programming schedules and even setup a **Schedule Viewing**. Press **Guide** to launch the guide.

Make sure that the date and time is set properly under the **System** → **Time** → **Clock** menu.

Using Channel View

- **A** (**Quick Nav**): Press **A** button. A popup window will open. Each press of **◀** or **▶** arrow button moves the focus 24 hours back or forward, enabling faster browsing of the programming schedule. However, the focus cannot be on a time prior to the current time.
- **B** (**Channel Category**): The TV's channel index is divided into different categories such as **Favourites 1-5**, **Show All** and **TV**. Choose a category.
- **C** (**Schedule Manager**): Press **C** button and navigate to the **Schedule Manager** screen to view a list of reserved programmes.

Basic Features

Schedule Manager

MENU → Broadcasting → Schedule Manager









Configure the TV to show a specific channel or programme at a specific time and date. Before scheduling TV watching, make sure that the date and time is set properly under the **System** → **Time** → **Clock** menu.

The  icon appears next to programmes that have been configured for a **Schedule Viewing**.

You can view, modify or delete a channel you have reserved to watch.

Using the Schedule Viewing

You can set a desired channel to be displayed automatically at the intended time. Set the current time first to use this function.

1. Press the  button to select **+ Schedule**.
2. Press the  /  /  /  buttons to set the **Aerial**, **Channel**, **Repeat**, **Date** or **Start Time**.
 - **Aerial**: Select the desired antenna source.
 - **Channel**: Select the desired channel.
 - **Repeat**: Select **Once**, **Manual**, **Sat~Sun**, **Mon~Fri** or **Everyday** to set at your convenience. If you select **Manual**, you can set the day you want.
 -  The  mark indicates the date is selected.
 - **Date**: you can set desired date.
 -  It is available when you select **Once** in **Repeat**.
 - **Start Time**: You can set start time you want.
 -  On the Information screen, you can change or cancel a reserved information.
 - **Delete**: Delete a show you have reserved to watch.
 - **Edit**: Change a show you have reserved to watch.

Basic Features

Digital Channel Schedule Viewing

Schedule Viewing for programmes on digital channels can be set up through the following two options:

- **Guide**
From **Guide**, select a programme you wish to view.
- **Programme Info**
Press **INFO*i*** button and select a programme you wish to view.

Analogue Channel Schedule Viewing

The **Schedule Viewing** function for programmes on analogue channels can be set up by specifying the time and date. Run **Schedule Manager** and then select **Schedule**. A popup menu will appear. Select **Schedule Viewing** to proceed. Specify that programme's **Channel**, **Repeat**, and **Start Time** and then select, **OK** to finish.

Cancel a Schedule Viewing

To cancel a Schedule Viewing for a specific programme, select the programme from the **Schedule Manager** screen. A popup menu will appear. Select **Delete** to cancel.

Edit Timer List





Select an entry from the **Schedule Manager** screen and then select **Edit** from the popup menu. Edit the settings of the selected entry.

Basic Features

Edit Channel

MENU → Broadcasting → Edit Channel

You can add,  (Go To) edit or delete channels.

- **A** (Change Number): Edit the number by pressing the number buttons desired.
 This function may not support depending on the region.
- **B** (Delete): You can delete a channel to display the channels you want.
- **C** (Lock/Unlock): Lock a channel so that the channel cannot be selected and viewed. Unlock a locked channel. Default PIN is: 0-0-0-0.
- **D** (Select All / Deselect All): You can select all the channels or cancel all the selected channels.
-  (Go To): You can enter a channel number immediately using your remote control.
-  Page: Move to next or previous page.
- **TOOLS** : Show the Tools list.

Remove channels

MENU → Broadcasting → Edit Channel

Remove registered channels from the index. Removing channels appearing in the channel list clears the channels from the list only and does not remove them from the index.

1. From the screen, select the channels you wish to remove. Unselect channels by choosing them again.
2. Press **B** button. A pop-up appears asking **Delete the selected channels?**, select **Yes**. The selected channel(s) will be deleted.

Rename Analogue Channels



Select a channel you wish to rename from the **Edit Channel** screen, press **TOOLS**  button, and then select **Rename channels** from the list. (Analogue channels only)

You can now rename the selected channel. The new name can be up to 5 characters long.

Edit Favourites **TOOLS**

MENU → Broadcasting → Edit Favourites

You can designate frequently watched channels as favourites. Favourites channels are highlighted in **Edit Channel** and channel list screens with the  symbol. You can create up to 5 favourites channel lists. You can also rename and edit favourites channel lists.

- **A** (Category): Show up the channel list by the following categories: **All, TV, Analogue, Recently Viewed, Most viewed**.
- **B** (Change Fav.): Show up a favourite list.
- **C** (Select All / Deselect All): Select or deselect all the channels.
- **D** (Add / Delete): Add / delete the channel to / from a favourite list.
-  (Go To): You can enter a channel number immediately using your remote control.
-  Page: Move to next or previous page.
- **TOOLS** : Show the Tools list.

Basic Features

Add Channels

Add a channel to a favourites channels list.

1. Press **A** button to bring up the channel list containing the channels you wish to add and then select the channels.
2. Press **B** button to bring up a favourites channels list and then **D** button to add the selected channels.

Remove Channels

Remove channels from a favourites channels list.

1. Press **B** button to bring up a favourites channels list and then select the channels you wish to remove.
2. Press **D** button to remove the channels from the list.

Rename a Favourites Channel List

Rename an existing favourites channels list.

1. Press **TOOLS** button and select **Rename Favourites** from the list.
2. Rename the list in the popup window. The new name can be up to 20 characters long.

Rearrange the Favourites Channels List

Rearrange the order of the channels in a Favourites Channels List.

1. Press **B** button to bring up a favourites channels list and select the channel you wish to move.
2. Press **A** button to rearrange the order of the selected channel. Press **↔** button.

Copy a Favourites Channels List

Copy channels from one favourites channels list to another.

1. Press **B** button to bring up a Favourites Channels List and select the channels you wish to copy.
2. Press **TOOLS** button, select **Copy to Favourites** from the list, and then select the Favourites Channels List(s) you wish to copy to. This copies over the channels to the selected Favourites Channels List(s).

Other Features

Fine Tune

MENU → **Broadcasting** → **Channel Settings** → **Fine Tune**

(Analogue channels only)

If the reception is clear, you do not have to fine tune the channel, as this is done automatically during the search and store operation. If the signal is weak or distorted, fine tune the channel manually. Scroll to the left or right until the image is clear.

- ✎ Select the channel, and then select **Fine Tune**.
- ✎ Fine tuned channels that have been saved are marked with an asterisk "*" on the right-hand side of the channel number in the channel banner.
- ✎ To reset fine-tuning, select the channel, select **Fine Tune**, and then select **Reset** on the **Fine Tune** screen.

Transfer Channel List

MENU → **Broadcasting** → **Channel Settings** → **Transfer Channel List**

Imports or exports the channel map. You should connect USB storage to use this function.

- ✎ The PIN input screen appears. Enter the PIN using your remote.
- **Import from USB:** Import channel list from USB.
- **Export to USB:** Export channel list to USB. This function is available when USB is connected.
 - ✎ USB format should be FAT32 and NTFS.

Delete CAM Operator Profile

MENU → **Broadcasting** → **Channel Settings** → **Delete CAM Operator Profile**

Selects the CAM operator to delete.

Subtitle **TOOLS**

MENU → **Broadcasting** → **Subtitle**

Use this menu to set the **Subtitle** mode.

- **Subtitle (Off / On):** Switches subtitles on or off.
 - **Subtitle Mode (Normal / Hearing Impaired):** Sets the subtitle mode.
 - **Subtitle Language:** Sets the subtitle language.
- **Primary Subtitle:** Set the primary subtitle language.
- **Secondary Subtitle:** Set the secondary subtitle language.
- ✎ If the programme you are watching does not support the **Hearing Impaired** function, **Preferred** automatically activates even if the **Hearing Impaired** mode is selected.
- ✎ English is the default in cases where the selected language is unavailable in the broadcast.

Basic Features

Audio Options

[MENU](#) → [Broadcasting](#) → [Audio Options](#)

- **Audio Language**

(Digital channels only)

Change the default value for audio languages.

 The available language may differ depending on the broadcast.

- **Primary Audio:** Set the primary audio language.
- **Secondary Audio:** Set the secondary audio language.

- **Audio Format**

(Digital channels only)

When sound is emitted from both the main speaker and the audio receiver, a sound echo may occur due to the decoding speed difference between the main speaker and the audio receiver. In this case, use the product Speaker function.

 **Audio Format** option may differ depending on the broadcast.

- **Audio Description**

(Digital channels only)

This function handles the Audio Stream for the AD (Audio Description) which is sent along with the Main audio from the broadcaster.

 **Audio Description (Off / On):** Turn the audio description function on or off.

 **Volume:** Adjust the audio description volume.

 This function is not available on certain models in specific geographical areas.

Teletext Language

[MENU](#) → [Broadcasting](#) → [Teletext Language](#)

Set a desired language for teletext.

 English is the default in cases where the selected language is unavailable in the broadcast.

Digital Text (UK only)

[MENU](#) → [Broadcasting](#) → [Digital Text](#)

If the programme broadcasts with digital text, this feature is enabled.

 MHEG (Multimedia and Hypermedia Information Coding Experts Group) An International standard for data encoding systems used in multimedia and hypermedia. This is at a higher level than the MPEG system which includes data-linking hypermedia such as still images, character service, animation, graphic and video files as well as multimedia data. MHEG is user runtime interaction technology and is being applied to various fields including VOD (Video-On-Demand), ITV (Interactive TV), EC (Electronic Commerce), tele education, teleconferencing, digital libraries and network games.

Basic Features

Common Interface

[MENU](#) → [Broadcasting](#) → [Common Interface](#)

- **CI Menu:** This enables the user to select from the CAM-provided menu. Select the CI Menu based on the menu CI Card.
 - **CAM video transcoding:** You can configure the setting to transcode the video codec from the CAM automatically. Turn it Off if you do not want to use it.
 - ✎ You must use a CAM that supports transcoding the video codec.
 - **Application Info:** View information on the CAM inserted into the CI slot and on the "CI or CI+ CARD" which is inserted into the CAM. You can install the CAM anytime whether the TV is on or off.
1. Purchase a CI CAM module at your nearest dealer or by phone.
 2. Firmly insert the "CI or CI+ CARD" into the CAM in the direction of the arrow.
 3. Insert the CAM with the "CI or CI+ CARD" into the common interface slot, in the direction of the arrow so that it aligns parallel with the slot.
 4. Check if you can see a picture on a scrambled signal channel.

Setting the Time

Time

MENU → System → Time

 The time you set will appear when you press the **INFO*i*** button.

- **Clock**

Set the clock to use the various timer features of the product.

 If you disconnect the power cord, you have to set the clock again.

Clock Mode: Set the current time manually or automatically.

— **Auto:** The product sets the current time automatically using the time from a digital channel.

 You must have the cable or an aerial connected to the product to set the time automatically.

 Depending on the broadcast station and signal, the auto time set up may not be correct. In this case, set the time manually.

— **Manual:** Set the current time manually.

Clock Set: Set the **Date** and **Time** manually. You can set the current date and time using your remote.

 Available only when the **Clock Mode** is set to **Manual**.

Time Zone: Select your time zone.

 This function is only available when the **Clock Mode** is set to **Auto**.

GMT: Selects your time zone.

 When **Country** is set to **Others**, you can use this function.

DST: Switches the DST (Daylight Saving Time) function on or off.

 This function is only available when the **Clock Mode** is set to **Auto**.

- **Sleep Timer**

Automatically shuts off the product after a preset period of time. (30, 60, 90, 120, 150, or 180 minutes).

 Select a period of time using your remote. To cancel the **Sleep Timer**, select **Off**.

Preference Features

- **On Timer**

Set **On Timer** so that your product turns on automatically at a time and on a day of your choosing. You can set up three separate **On Timer** configurations. (**On Timer 1**, **On Timer 2**, **On Timer 3**) and select the source of the content the product plays when it turns on: an aerial or cable channel, a USB device, or a set-top box connected to one of the product's inputs (HDMI1, AV, etc.).

 You must set the clock before you can use the **On Timer** function.

Setup: Select **Off**, **Once**, **Everyday**, **Mon-Fri**, **Mon-Sat**, **Sat-Sun** or **Manual**. If you select **Manual**, you can choose the days you want **On Timer** to turn on your product.

 The  mark indicates days you've selected.

Time: Set the time that the product turns on automatically.

Volume: Set the desired volume level. Change the volume level using your remote.

Source: To select what will be turned on when the timer setting is activated. You can set the product to turn on a specific channel or play back contents such as **Photos**, **Videos** or **Music** files located in an external device connected to the product.

 The USB device must be connected to your product before you can select **USB**.

Aerial (when the **Source** is set to **TV**): Select **ATV** or **DTV**.

Channel (when the **Source** is set to **TV**): Select the desired channel.

Music / Photo (when the **Source** is set to **USB**): Select a folder in the USB device containing music or photo files you want played when the product turns on automatically.

 If there is no music file on the USB device or you don't select a folder containing a music file, the Timer function does not operate correctly.

 If there is only one photo file in the USB, the slide show will not play.

 If a folder name is too long, the folder cannot be selected.

 Each USB you use is assigned its own folder. When using more than one of the same types of USB, make sure the folders assigned to each USB have different names.

 We recommend that you use a USB memory stick and a multi card reader when using the **On Timer**. The **On Timer** function may not work with USB devices that have a built-in battery, MP3 players, or PMPs made by some manufacturers because the product can take too long to recognise these devices.

 If you set the **On Timer** to play a file saved on a USB devices, it may take up to 40 seconds or more to play the file after the product is turned on.

- **Off Timer**

Set **Off Timer** so that your product turns off automatically at a time and on a day of your choosing. You can set up three separate **Off Timer** configurations. (**Off Timer 1**, **Off Timer 2**, **Off Timer 3**)

 You must set the clock before you can use the **Off Timer**.

Setup: Select **Off**, **Once**, **Everyday**, **Mon-Fri**, **Mon-Sat**, **Sat-Sun** or **Manual**. If you select **Manual**, you can choose the days you want **Off Timer** to turn off your product.

 The  mark indicates days you've selected.

Time: Set the time that the product turns off automatically.

Economical Solutions

Eco Solution

MENU → System → Eco Solution

- **Energy Saving**
Lets you adjust the brightness of the product in order to reduce power consumption.
- **No Signal Power Off**
To avoid unnecessary energy consumption, you can set how long you want the product to remain on if it's not receiving a signal.
- **Auto Power Off**
The product will automatically turn off if you don't press a button on your remote or product controller within 4 hours to prevent overheating.

Auto Protection Time

MENU → System → Auto Protection Time

If the screen displays a still image for a certain period of time you define, the product activates the screen saver to prevent the formation of burnt in ghost images on the screen.

Blocking Programmes

Programme Rating Lock

[MENU](#) → [Broadcasting](#) → [Programme Rating Lock](#)

(Depending on the country)

When turned on, the [Programme Rating Lock](#) feature can automatically block programmes that you deem inappropriate for your children. You must enter a PIN (personal identification number) before you can set or change any of the [Programme Rating Lock](#) restrictions.

 The items of [Programme Rating Lock](#) differs depending on the country.

How to watch a restricted programme or movie

If the product is tuned to a restricted programme or movie, the [Programme Rating Lock](#) will block it. The screen will go blank and the popup message appears. Enter the PIN to unblock the programme or movie using your remote.

Change PIN

[MENU](#) → [System](#) → [Change PIN](#)

The [Change PIN](#) screen will appear. Choose any 4 digits for your PIN and enter them in the [Enter New PIN](#). Reenter the same 4 digits in the [Confirm New PIN](#). When the Confirm screen disappears, select [Close](#). The product has memorised your new PIN.

Channel Lock

[MENU](#) → [Broadcasting](#) → [Channel Lock](#)

The PIN input screen appears. Enter your 4-digit PIN, the default of which is "0-0-0-0".

Lock channels in [Channel](#) menu, to prevent unauthorise users, such as children, from watching unsuitable programme.

 Available only when the [Source](#) is set to [TV](#).

Other Features

Menu Language

MENU → System → Menu Language

Set the menu language.

General

MENU → System → General

- **Max. Power Saving**

When the product is attached to a PC, conserves power by turning the product off when the PC is not used for period of time you specify.

 Available only when the **Source** is set to **PC**.

- **Game Mode**

When you have connected a game console such as a PlayStation™ or Xbox™ to the product, you can enjoy a more realistic gaming experience if you set the **Game Mode** on.

Precautions and limitations for Game Mode

— Before disconnecting a game console and connecting another external device, set **Game Mode** to **Off**.

— If you display the product menu in **Game Mode**, the screen shakes slightly.

 **Game Mode** is not available when the input source is set to **TV** or **PC** source.

 Set **Game Mode** to **On** only after connecting a game console. If you turn **Game Mode** on before you have attached the game console, you may notice reduced picture quality.

 If the **Game Mode** is set to **On**, **Picture Mode** is set to **Game** and **Sound Mode** is set to **Game** automatically.

- **Panel Lock**

Lock or unlock all the keys on the product Controller at once. When **Panel Lock** is on, the product Controller does not operate.

- **Boot Logo**

Displays the Samsung logo when the product is turned on.

Preference Features

Anynet+ (HDMI-CEC)

MENU → **System** → **Anynet+ (HDMI-CEC)**

Allows you to control all connected Samsung devices that support anynet+ with your Samsung product's remote. For details on set up options, refer to the "Anynet+ (HDMI-CEC)" instructions. (page 69)

DivX® Video On Demand

MENU → **System** → **DivX® Video On Demand**

Shows the registration code authorised for the product. If you connect to the DivX web site and register with 10-digit registration code, you can download the VOD activation file. Once you play it using Media Play, the registration is completed.

 For more information on DivX(R) VOD, visit <http://vod.divx.com>.

Support Menu

Self Diagnosis

[MENU](#) → [Support](#) → [Self Diagnosis](#)

- **Picture Test**

Use to check for picture problems. [Picture Test](#) displays a high definition picture that you can examine for flaws or faults.

Yes: Select **Yes** if the test picture does not appear or there is noise or distortion in the test picture. There may be a problem with the product. Contact Samsung's Call Centre for assistance.

No: Select **No** if the test picture displays properly. There may be a problem with your external equipment. Please check your connections. If the problem persists, refer to the external device's user manual.

- **Sound Test**

Use the built-in melody to check for sound problems.

Yes: Select **Yes** if you can hear sound from only one speaker or from neither speaker during the sound test. There may be a problem with the product. Contact Samsung's Call Centre for assistance.

No: Select **No** if you can hear sound from the speakers. There may be a problem with your external equipment. Please check your connections. If the problem persists, refer to the external device's user manual.

- **Signal Information**

(Digital channels only)

The reception quality of over-the-aerial HD channels is either perfect or the channels are unavailable. Signal Information displays HD channel signal strength so you can adjust your aerial to increase signal strength and receive HD channels.

- **Reset**

Reset all setting to factory defaults.

To reset your product to default setting, follow these steps:

1. Go to the [Reset](#) menu. ([Support](#) → [Self Diagnosis](#) → [Reset](#))
2. The PIN input screen appears. Enter the four digit security PIN using your remote.
3. When done, the PIN screen disappear automatically. The message "[All the settings will return to factory defaults.](#)" appears.
4. Select **Yes**. All settings are reset. The product will turn off and on again automatically. The [Setup](#) screen appears. For more information about [Setup](#), see the paper user manual.

Preference Features

Software Update

[MENU](#) → [Support](#) → [Software Update](#)

The [Software Update](#) menu lets you upgrade your product's software to the latest version.

Current Version: This is the software version already installed in the product.

Upgrading to the Latest Version

Check your TV's software version and upgrade it if necessary.

 The TV will turn off and on automatically after completing the software upgrade. All video and audio settings return to the default settings after a software upgrade.

- **Update now**
Download the latest update file from the Samsung website. Decompress the file and copy it into the root directory of a flash drive. Insert the flash drive into the USB port to install the update.
- **Auto update**
The TV will be updated automatically at the time you have set or after power off.

Use Mode

[MENU](#) → [Support](#) → [Use Mode](#)

Select the [Use Mode](#) suitable for your place. We strongly recommend you select [Home Use](#).

- **Home Use:** Home Use is the default setting.
- **Store Demo:** [Store Demo](#) is for retail environments only. If you select [Store Demo](#), some functions will not work, and the picture settings will be reset every 5 minutes.

Contact Samsung

[MENU](#) → [Support](#) → [Contact Samsung](#)

View this information when your product does not work properly or when you want to upgrade the software. You can find information regarding our call centres and how to download products and software.

Application

Application Menu

[MENU](#) → [Applications](#)

Source List

[MENU](#) → [Applications](#) → [Source List](#)

- ✎ When you press the [SOURCE](#) button, [Source](#) screen will be displayed at once.
- ✎ You can only choose external devices that are connected to the TV. In [Source](#), connected inputs are highlighted.
- ✎ For the detailed information, refer to “Changing the Input Source” in User Manual.



Connecting a USB Device

1. Turn on your TV.
 2. Connect a USB device containing photo, music and movie files to the USB port behind the TV.
 3. When USB is connected to the TV, popup window appears. You can select the [Photos](#), [Videos](#) or [Music](#) directly.
 - ✎ It might not work properly with unlicensed multimedia files.
 - ✎ Need-to-Know List before using Media Contents.
- MTP (Media Transfer Protocol) is not supported.
 - The file system supports NTFS (Read Only), FAT16 and FAT32.
 - Certain types of USB Digital camera and audio devices may not be compatible with this TV.
 - Media Contents only supports sequential jpeg format.
 - Media Contents only supports USB Mass Storage Class (MSC) devices. MSC is a Mass Storage Class Bulk-Only Transport device. Examples of MSC are Thumb drives, Flash Card Readers (USB HUB are not supported). Devices should be connected directly to the TV's USB port.
 - Before connecting your device to the TV, please back up your files to prevent them from damage or loss of data. SAMSUNG is not responsible for any data file damage or data loss.
 - The HDD (Hard Disk Drive) connected to USB is not supported.
 - Do not disconnect the USB device while it is loading.
 - The higher the resolution of the image, the longer it takes to display on the screen.
 - The maximum supported JPEG resolution is 15360 x 8640 pixels.
 - For unsupported or corrupted files, the “Not Supported File Format” message is displayed.
 - The scene search and thumbnail functions are not supported in the [Videos](#).
 - MP3 files with DRM that have been downloaded from a non-free site cannot be played. Digital Rights Management (DRM) is a technology that supports the creation, distribution and management of the content in an integrated and comprehensive way, including the protection of the rights and interests of the content providers, the prevention of the illegal copying of contents, as well as managing billings and settlements.

Advanced Features

- A USB device that requires high power (more than 500mA or 5V) may not be supported.
- If the TV has been no input during time set in [Auto Protection Time](#), the screen saver will run.
- If a USB extension cable is used, the USB device may not be recognised or the files on the device may not be read.
- If a USB device connected to the TV is not recognised, the list of files on the device is corrupted or a file in the list is not played, connect the USB device to the PC, format the device and check the connection.
- If a file deleted from the PC is still found when Media Contents is run, use the “Empty the Recycle Bin” function on the PC to permanently delete the file.
- If the number of files and folders saved on a USB storage device is approximately over 4000, the files and folders may not appear and some folders may not be opened.

Disconnecting a USB Device



1. Press the **SOURCE**  button.
2. Select a desired USB device, and then press the **TOOLS**  button. The Tools menu appears.
3. Select **Disconnect USB Device**, and then wait until the selected USB device is disconnected. You can remove a USB device from the TV.

 To remove a USB device from the TV, we recommend use **Disconnect USB Device** function.





Media Play

MENU → **Applications** → **Media Play**

Enjoy photos, music and movie files saved on a USB Mass Storage Class (MSC) device.

1. Press the **MEDIA.P** button.
2. Press **◀/▶** button to select desired menu, then press the  button.
3. Press **◀/▶** button to select desired device, then press the  button again.
4. Press the **▲/▼/◀/▶** button to select the desired file in the list, then press the  button or **▶** (Play) button.

Playing the selected files

1. Press the **▲** button to select **Options** at the top of each main screen and select **Play Selected**.
2. Select the desired files.
 -  The check box appears to the left of the selected files.
 -  Press  button again to deselect the file.
3. Press the **▲** button to select **Play**.
 -  You can select or deselect all files pressing the **Select All / Deselect All**.



Video Playback

MEDIA.P → Videos

You can play video files saved on USB device and/or your PC.

 For more information about the subtitle formats and codec formats, refer to "Supported Subtitle and Media Play file formats" in the Other Information section.

Video Playback

Select the video file from the list or press **▶** to play video. Use the remote control or the on-screen buttons to control the video playback. Press **☰** or **TOOLS**  to bring up the on-screen buttons and **RETURN**  to hide them. To stop playing the file, press **■** or **RETURN** .

Playlist Creation

From the **Options** list located at the top of the screen, select **Play Selected**, specify all the video files you wish to play, and then select **Play**. This creates a playlist. If the list is displayed in Folder view mode, only the files contained in the current folder can be selected. To select files from other folders, change the view mode.

Opening a Different File

- Select the **◀▶** on-screen button.
- Select the **Search** on-screen button and then select **Search Titles**.

Video Scanning

- Press **◀ / ▶**. This scans through the file in 10-second increments.
- Press **◀ / ▶**. This changes the playback speed by up to 300%. To restore normal playback speed, press **▶**. Alternatively, pause the video and then press **▶** to reduce the playback speed (1/8 normal, 1/4 normal, 1/2 normal). Slow playback doesn't support audio and is available in the forward direction only.
- Press **⏸** to pause the screen and then **⏮** to scan through the paused video in 1-frame increments. Audio is not supported while the video is paused.
- Select the **Search** on-screen button and then select **Search Titles**. This will take you to a scene in the video.
- Select the **Search** on-screen button and then select **Search Time Bar**. This will take you to a time frame in the video.
- Select the **◀** on-screen button. This plays the video from the beginning.

Show Subtitles

If the external storage device contains a subtitle file with the same name as the video file being played, you can choose to display subtitles on the screen. Select the **Settings** on-screen button and then select **Subtitle Settings** to show subtitles.

If the letters appear corrupted, try changing the encoding setting. If the subtitles do not match the video, adjust the sync. If the subtitles are too small, increase the font size.

Advanced Features

Additional Video Playback Settings



- **Repeat Mode**
Select the **Repeat Mode** on-screen button. This changes the repeat mode. **Repeat One** repeats the current file only, whereas **Repeat All** repeats all files contained in the folder.
- **Picture Size**
Select the **Picture Size** button and then select the picture size.
- **Picture Mode**
Select the **Settings** on-screen button and then select **Picture Mode**. Select a picture mode.
- **Sound Mode**
Select the **Settings** on-screen button and then select **Sound Mode**. Select a sound mode.
- **Information**
Select the **Settings** on-screen button and then select **Information** to view detailed information about the current video.
- **Subtitle Settings**
Select the **Settings** on-screen button and then select **Subtitle Settings** to play the video with subtitles. This function only works if the subtitles are the same file name as the video.
- **Audio Language**
Select the **Settings** on-screen button and then select **Audio Language** to change the audio language if the video has more than one language.

Photo Playback



MEDIA.P → Photos

Select a photo from the list to display it on the screen. Press  or **TOOLS**  to bring up the on-screen buttons and **RETURN**  to hide them. To stop playing the file, press  or **RETURN** .

Slide Show

- From the **Options** list located at the top of the screen, select **Slide Show**. You can view all photos in the list as a slideshow.
- Press  from the list.
- Press  or select the **Start Slide Show** on-screen button to begin the slideshow.

Slideshow Settings

- Slide Show Speed: Press  /  or select the **Slide Show Settings** on-screen button and then select **Speed**.
- Slide Show Effect: Select the **Slide Show Settings** on-screen button and then select **Effects**.

Playlist Creation

From the **Options** list located at the top of the screen, select **Play Selected**, specify all the photos you want to play, and then select **Play**. This creates a playlist. If the list is displayed in Folder view mode, only the files contained in the current folder can be selected. To select files from other folders, change the view mode.

Opening a Different File

- Press  / .
- Select the **Previous/Next** on-screen button.

Background Music

Enable music to play in the background during a slideshow. However, all music files must be located on the same storage device.

Select the **Background Music** on-screen button while a photo is displayed on the screen or a slideshow is in progress. Select the music files you want to listen to and then **Play**. To play the files in a random order, select **Shuffle**.

Advanced Features

Mini Player

When viewing photos with background music, you can control the music. Select **Background Music** from among the on-screen control buttons and select **Mini Player**. You can pause playback or skip to the previous or next song.

Additional Photo Playback Settings

- **Zoom:** Select the **Zoom** on-screen button. Zoom in by up to a factor of 4.
- **Rotate:** Select the **Rotate** on-screen button. This rotates the photo.
- **Picture Mode:** Select the **Settings** on-screen button and then select **Picture Mode**. Select a picture mode.
- **Sound Mode:** Select the **Settings** on-screen button and then select **Sound Mode**. Select a sound mode.
- **Information:** Select the **Settings** on-screen button and then select **Information** to view detailed information about the current video.

Music playback

MEDIA.P → Music

Select the music file from the list or press ► to play music. Use the remote control or the on-screen buttons to control the video playback. To stop playing the file, press ■ or RETURN↵.

Playlist Creation

From the **Options** list located at the top of the screen, select **Play Selected**, specify all the music files you want to play, and then select **Play**. This creates a playlist. If the list is displayed in Folder view mode, only the files contained in the current folder can be selected. To select files from other folders, change the view mode.

Music Scanning

- Press ◀ / ▶. This scans through the file in 10-second increments.
- Press ⏸. This pauses the currently playing music file.

Opening a Different File

- Select the ◀◀/▶▶ on-screen button.
- Select a file from the playlist.



Additional Music Playback Settings

- **Shuffle**
Select the **On** on-screen button. Choose between normal and random play.
- **Repeat**
Select the **Repeat** on-screen button. This changes the repeat mode. **One Song** repeats the current file only, whereas **All** repeats all files contained in the playlist.
- **Sound Mode**
Select the **Sound Mode** on-screen button. Select a sound mode.
- **Information**
Press **INFO*i*** from the playlist to view detailed information for the selected file.

Sports Mode **TOOLS**

MENU → Applications → Sports Mode

This mode provides optimized condition for watching sports games.

- **A (Zoom)**: Pause playback and divide the picture into 9 parts. Select a part to zoom it in. Press this button again to resume.
-  When the **Sports Mode** is **On**, the picture and sound modes are set to **Stadium** automatically.
-  If you turn the TV off while watching **Sports Mode**, the **Sports Mode** will be disable.
-  **Zoom** doesn't operate in the following modes:
 - PIP On
 - Media play videos
 - Anynet+ (HDMI-CEC)
 - Digital Text (UK Only)

FreeSync

 This function is not available on certain models.

MENU → **Applications** → **FreeSync**

FreeSync technology is solution that eliminates screen tearing without all the usual lag and latency.

This feature will eliminate screen tearing and lag during game play. Improve your gaming experience.

 **FreeSync** is only available in **HDMI** mode.

- **Off**: Disable **FreeSync**.
- **Standard Engine**: Enable the basic **FreeSync** functions of the AMD graphics card.
- **Ultimate Engine**: Enable the **FreeSync** feature with a higher screen frame rate. Screen tearing (abnormal sync between the screen and content) is reduced in this mode. Note that screen flickering may occur during game play.

When enable **FreeSync** function, please use maximum screen refresh rate for optimal freesync effect.

 The refresh rate setting method

- Windows XP: Go to Control Panel → Appearance and Themes → Display → Settings → Advanced → Monitor, and adjust Refresh rate under Monitor settings.
- Windows ME/2000: Go to Control Panel → Display → Settings → Advanced → Monitor, and adjust Refresh rate under Monitor settings.
- Windows Vista: Go to Control Panel → Appearance and Personalization → Personalization → Display Settings → Advanced Settings → Monitor, and adjust Refresh rate under Monitor settings.
- Windows 7: Go to Control Panel → Appearance and Personalization → Display → Screen Resolution → Advanced settings → Monitor, and adjust Refresh rate under Monitor settings.
- Windows 8(Windows 8.1): Go to Settings → Control Panel → Appearance and Personalization → Display → Screen Resolution → Advanced settings → Monitor, and adjust Refresh rate under Monitor settings.
- Windows 10: Go to Settings → System → Display → Advanced display settings → Display adapter properties → Monitor, and adjust Screen refresh rate under Monitor settings.

 When using the **FreeSync** function, use the HDMI cable provided by the TV Monitor manufacturer.

If the FreeSync function is enabled, the following may occur:

- The screen may flicker when you play games depending on the game option settings. Decreasing the game setting values might help to remove the flicker. Installing the latest drivers from the AMD website may also fix this issue.
 - The response rate during the game may fluctuate depending on the resolution. A higher resolution generally decreases the response rate.
 - The sound quality of the monitor may be degraded.
-  If you encounter any issues when using the function, contact the Samsung Service Centre.

Advanced Features

The models in the Graphic Cards list supports FreeSync

FreeSync can only be used with specific AMD graphics card models. Refer to the following list for supported graphics cards:

Make sure to install the latest official graphics drivers from AMD that support **FreeSync**.

✎ For additional AMD graphics card models that support the **FreeSync** feature, visit the official AMD website.

✎ Select **FreeSync Off** if you are using a graphics card from a different manufacturer.

- AMD Radeon R9 300 Series
- AMD Radeon R9 Fury X
- AMD Radeon R7 360
- AMD Radeon R9 295X2
- AMD Radeon R9 290X
- AMD Radeon R9 290
- AMD Radeon R9 285
- AMD Radeon R7 260X
- AMD Radeon R7 260

How do you enable FreeSync?

✎ The following contents are just for reference as an example.

1. Set **FreeSync** to **Standard Engine** or **Ultimate Engine** in the OSD menu.
2. Enable **FreeSync** in AMD Radeon Settings:

Right-click the mouse → AMD Radeon Settings → Display



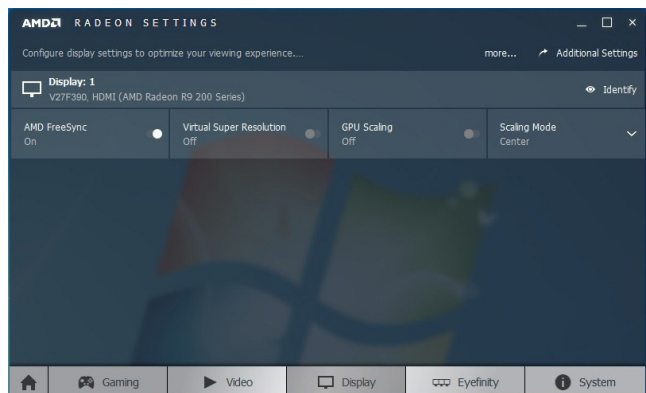
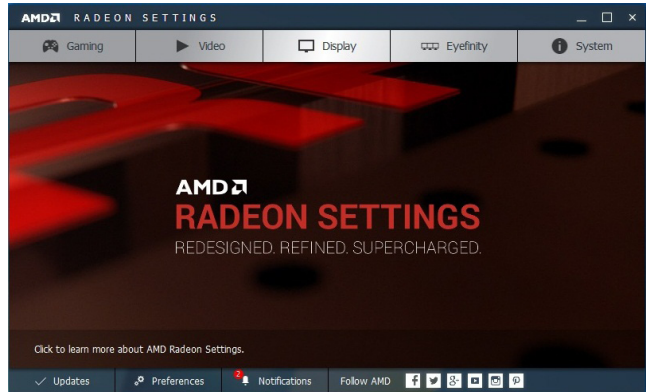
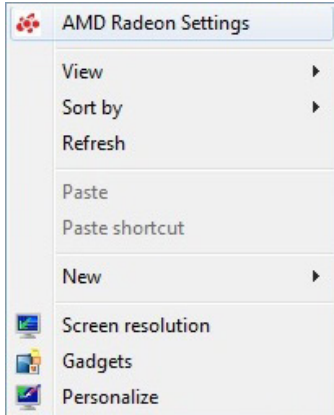



The "AMD FreeSync" feature should be set to "On". Select to "On" if not already enabled.



Anynet+ (HDMI-CEC)

MENU → **System** → **Anynet+ (HDMI-CEC)**



Anynet+ is a function that enables you to control all connected Samsung devices that support Anynet+ with your Samsung TV's remote. The Anynet+ system can be used only with Samsung devices that have the Anynet+ feature. To be sure your Samsung device has this feature, check if there is an Anynet+ logo on it.

-  You can only control Anynet+ devices using the TV's remote control, not the buttons on the product.
-  The product remote control may not work under certain conditions. If this occurs, reselect the Anynet+ device.
-  The Anynet+ functions do not operate with other manufacturers' products.
-  For instructions explaining how to connect Anynet+ external devices, refer to the device's user manual. You must connect an Anynet+ device using an HDMI cable. Some HDMI cables may not support Anynet+ functions.
-  Anynet+ works when the AV device supporting Anynet+ is in the standby or on status.
-  Anynet+ supports up to 12 AV devices in total. Note that you can connect up to 3 devices of the same type.



Advanced Features

Anynet+ (HDMI-CEC) Menu

The Anynet+ menu changes depending on the type and status of the Anynet+ devices connected to the product.



- **View TV**
Change from Anynet+ mode to product broadcast mode.
- (device_name) **MENU**
Shows the menu of the connected device. E.g. if a DVD player is connected, the disc menu of the DVD player will appear.
- (device_name) **Tools**
Shows the **Tools** menu of the connected device. E.g. if a DVD player is connected, the **Tools** menu of the DVD player will appear.
 Depending on the device, this menu may not be available.
- (device_name) **Title Menu**
Shows the title menu of the disc in the connected device. E.g. If a DVD player is connected, the title menu of the movie in the DVD player will appear.
 Depending on the device, this menu may not be available.

Setting up Anynet+ (HDMI-CEC)

- **Anynet+ (HDMI-CEC)**
To use the Anynet+ Function, **Anynet+ (HDMI-CEC)** must be set to **On**.
 When the **Anynet+ (HDMI-CEC)** function is disabled, all the Anynet+ related operations are deactivated
- **Auto Turn Off**
Set an Anynet+ Device to turn off automatically when the product is turned off.
 If **Auto Turn Off** is set to **Yes**, running external devices will turn off at the same time as the product powers off.
 May not be enabled depending on the device.

Advanced Features

Switching between Anynet+ Devices

1. Open the **Tools** menu using your remote, and then select **Anynet+ (HDMI-CEC)**.
 2. Select a device, and then wait until the switch to the selected device is completed.
-  The menu appears only when you set **Anynet+ (HDMI-CEC)** to **On** in the **System** menu.
 -  Switching to the selected device may take up to 2 minutes. You cannot cancel the switching operation while switching is in progress.
 -  If you have selected an Anynet+ device using the **Source** function, you cannot use the Anynet+ function. Make sure to switch to an Anynet+ device.

Troubleshooting

If the product seems to have a problem, first review this list of possible problems and solution. If none of the troubleshooting tips apply, visit www.samsung.com

Issues	Solutions and Explanations
Flickering and Dimming	<p>If your Samsung Television is flickering or dimming sporadically, you may need to disable some of its energy efficient features such as the Energy Saving feature. Follow the steps below with your remote to turn these features off or on.</p> <ul style="list-style-type: none"> • Energy Saving: MENU → System → Eco Solution → Energy Saving
Component Connections / Screen Colour	<p>If you find that the colour on your Samsung television's screen is not correct or black and white, first run a Self Diagnosis on the product to make sure there are no device issues.</p> <ul style="list-style-type: none"> • Self Diagnosis: MENU → Support → Self Diagnosis → Picture Test <p>If the problem does not appear in the Picture test, make sure:</p> <ul style="list-style-type: none"> • Your connections are all consistent. For example, if you've used the AV In jack on your product, make sure you have used the AV Out jack on your video source. • You have connected to your devices to the correct jacks. For example, if you use the Component jacks, labeled Pb, Pr, and Y, to connect your product and video source, make sure you have connected the blue Pb jack on the video source to the blue Pb jack on the product, the red Pr jack on the source to the red Pr jack on the product.
Screen Brightness	<p>If you find that the colours on your Samsung product are correct but just a little too dark or bright, try adjusting the following settings in the Picture option in the Main menu:</p> <ul style="list-style-type: none"> • Backlight, Contrast, Brightness, Sharpness, Colour, Tint (G/R) and so on. Go in to "Picture" on user Menu then try adjusting options mentioned above.
Unwanted Powering Off	<p>If your Samsung product appears to turn off by itself, there may be an issue with either your Timer settings or your Eco friendly No Signal Power Off feature. First make sure Sleep Timer is not accidentally set. The Sleep Timer turns off the product automatically after a certain period of time has passed.</p> <ul style="list-style-type: none"> • Sleep Timer: MENU → System → Time → Sleep Timer <p>If the Sleep Timer is not activated, you may have engaged the No Signal Power Off or Auto Power Off feature.</p> <ul style="list-style-type: none"> • No Signal Power Off: MENU → System → Eco Solution → No Signal Power Off • Auto Power Off: MENU → System → Eco Solution → Auto Power Off

Other Information

Issues	Solutions and Explanations
Trouble Powering On	<p>Before you turn the product on, find the blue light in the bottom of the right position product. Press the power on button on the product or remote and the light should blink about 5 times before the product turns on.</p> <p>If you find that you are having trouble powering on your Samsung television, there are a number of things to check before making a call to the service department.</p> <ul style="list-style-type: none"> If you happen to be using the product as a monitor and the stand-by light only blinks for a few seconds when you press the power button, your PC is in sleep mode. To take your PC out of sleep mode, press a key on your keyboard or move the mouse. Then try turning your product on. <p>If you're sure your power cord, remote control, and PC are functioning properly, you may be having a cable issue. If you have a cable or satellite box, your product may appear to be off because the cable or satellite box is not outputting a signal. To test the signal output of your cable or satellite box, press the guide or info button on the cable or satellite box remote control. If the screen displays the guide or info data, the problem is caused by the box.</p>
Cannot Find a Channel	Re-run Setup (Go to MENU → System → Setup) or run Auto Tuning . (Go to MENU → Broadcasting → Auto Tuning).

Issues	Solutions and Explanations
PC Connection	
A Mode Not Supported message appears.	Set your PC's output resolution so it matches a resolution supported by the product.
"PC" is always shown on the source list, even if a PC is not connected.	This is normal. "PC" is always shown in the source list, regardless of whether a PC is connected.
The video is OK but there is no audio.	If you are using an HDMI connection, check the audio output setting on your PC.
Picture	<p>First, perform the Picture Test and to see if your product is properly displaying the test image (go to MENU → Support → Self Diagnosis → Picture Test).</p> <p>If the test image is properly displayed, the poor picture may be caused by the source or signal.</p>
The product image does not look as good as it did in the store.	<p>Store displays are all tuned to digital, HD (high definition) channels.</p> <p>If you have an analogue cable/set top box, upgrade to a digital set top box. Use HDMI or Component cables to deliver HD (high definition) picture quality.</p> <p> Many HD channels are up scaled from SD (Standard Definition) contents. Look for a channel that is broadcasting true HD content.</p> <ul style="list-style-type: none"> Cable/Satellite subscribers: Try HD channels from the channel line up. Terrestrial/Cable Aerial connection: Try HD channels after performing an Auto Tuning. <p>Adjust the Cable/Sat box video output resolution to 1080i or 720p.</p>





Other Information

Issues	Solutions and Explanations
The picture is distorted: macro block error, small block, dots, pixelisation	The compression of video contents may cause picture distortion especially in fast moving pictures such as sports and action movies. A weak or bad quality signal can cause picture distortion. This is not a product issue. Mobile phones used close to the product (within 1 m) may cause noise in the picture on analogue and digital channels.
Colour is wrong or missing.	If you're using a Component connection, make sure the component cables are connected to the correct jacks. Incorrect or loose connections may cause colour problems or a blank screen.
The colour is poor or the picture is not bright enough.	Adjust the Picture options in the product menu (go to Picture Mode / Colour / Brightness / Sharpness) Adjust the Energy Saving option in the product menu (go to MENU → System → Eco Solution → Energy Saving) Try resetting the picture to view the default picture settings (go to MENU → Picture → Reset Picture).
There is a dotted line on the edge of the screen.	If the Picture Size is set to Screen Fit , change it to 16:9 . Change the cable/satellite box resolution.
The picture is black and white.	If you are using an AV composite input, connect the video cable (yellow) to the Green jack of Component on the product
When changing channels, the picture freezes or is distorted or delayed.	If the product is connected to a cable box, try to reset the box. (Disconnect and then reconnect the AC cord and wait until the cable box reboots. It may take up to 20 minutes.) Set the output resolution of the cable box to 1080i or 720p.

Other Information

Issues	Solutions and Explanations
Sound	First, perform the Sound Test to determine if your product audio is operating properly. (Go to MENU → Support → Self Diagnosis → Sound Test). If the audio is OK, the sound problem may be caused by the source or signal.
There is no sound or the sound is too low at maximum volume.	Please check the volume of the device (Cable/Sat Box, DVD, Blu-ray etc.) connected to your product.
The picture is good but there is no sound.	If you are using an external device, check the device's audio output option. (Ex. You may need to change your cable box's audio option to HDMI if you have the box connected to your product using an HDMI cable.) If you are using a DVI to HDMI cable, a separate audio cable is required. If your product has a headphone jack, make sure there is nothing plugged into it. Reboot the connected device by disconnecting, and then reconnecting device's power cable.
The speakers are making an inappropriate noise.	Check cable connections. Make sure a video cable is not connected to an audio input. For aerial or cable connections, check the signal information. A low signal level may cause sound distortion. Perform the Sound Test feature. (MENU → Support → Self Diagnosis → Sound Test)
RF (Cable / Aerial) Connection	
The product is not receiving all channels.	Make sure the coaxial cable is connected securely. Please try Setup to add available channels to the channel list. Go to MENU → System → Setup and wait for all available channels to be stored. Verify the aerial is positioned correctly.
The picture is distorted: macro block error, small block, dots, pixelisation.	The compression of video contents may cause picture distortion, especially with fast moving pictures such as sports and action movies. A weak signal can cause picture distortion. This is not a product problem.
Others	
Purple/green rolling horizontal bars and buzzing noise from the product speakers with a Component cable connection.	Remove the left and right audio connections from the Set-Top box. If the buzzing stops, this indicates that the Set-Top box has a grounding issue. Replace the Component video cables with an HDMI connection.
The picture won't display in full screen.	HD channels will have black bars on either side of the screen when displaying up scaled SD (4:3) contents. Black bars will appear on the top and bottom of the screen when you watch movies that have aspect ratios different from your product. Adjust the picture size options on your external device or the product to full screen.

Other Information



Issues	Solutions and Explanations
A Mode Not Supported message appears.	Check the supported resolution of the product, and adjust the external device's output resolution accordingly. Refer to the resolution settings of this manual.
There is a plastic smell from the product.	This smell is normal and will dissipate over time.
The product Signal Information is unavailable in the Self Diagnosis menu.	This function is only available for digital channels the product receives from an Aerial / RF / Coax connection.
The product is tilted to the side.	Remove the base stand from the product and reassemble it.
The channel menu is greyed out (unavailable).	The Channel menu is only available when you select the product source.
Your settings are lost after 5 minutes or every time the product is turned off.	If the product is in the Store Demo mode, it will reset audio and picture settings every 5 minutes. Change the settings from Store Demo mode to Home Use mode using the Setup procedure. Select TV in the Source using your remote, and go to MENU → System → Setup .
You have intermittent loss of audio or video.	Check the cable connections and reconnect them. Loss of audio or video can be caused by using overly rigid or thick cables. Make sure the cables are flexible enough for long term use. If mounting the product to a wall, we recommend using cables with 90 degree connectors.
You see small particles when you look closely at the edge of the frame of the product.	This is part of the product's design and is not a defect.
The PIP menu is not available.	PIP functionality is available when you are using a TV, PC, AV, Component, HDMI1/DVI or HDMI2 source.
POP (product's internal banner ad) appears on the screen.	<p>Select Home Use under Setup mode. For details, refer to the Setup Feature.</p> <ul style="list-style-type: none">  Watch these troubleshooting on video at www.samsung.com  Some functions and pictures shown in this manual are available on specific models only.  To keep your product in optimum condition, upgrade to the latest firmware on the Samsung web site by USB (samsung.com → Support → Downloads).
The product won't turn on.	<p>Make sure the AC power cord is securely plugged in to the wall outlet and the product.</p> <p>Make sure the wall outlet is working.</p> <p>Try pressing the  button on the product to make sure the problem is not the remote. If the product turns on, refer to "Remote control does not work" below.</p>

Other Information

Issues	Solutions and Explanations
There is no picture/video.	<p>Check the cable connections. Remove and reconnect all cables connected to the product and external devices.</p> <p>Set the video outputs of your external devices (Cable/Sat Box, DVD, Blu-ray etc) to match the product's input connections. For example, if an external device's output is HDMI, it should be connected to an HDMI input on the product.</p> <p>Make sure your connected devices are powered on.</p> <p>Be sure to select the correct input source.</p> <p>Reboot the connected device by unplugging it, and then reconnecting the device's power cable.</p>
The remote control does not work.	<p>Replace the remote control batteries. Make sure the batteries are installed with their poles (+/-) in the correct direction.</p> <p>Clean the sensor's transmission window on the remote.</p> <p>Try pointing the remote directly at the product from 1.5~1.8 m away.</p>
The cable/set top box remote control doesn't turn the product on or off, or adjust the volume.	<p>Programme the Cable/Set remote control to operate the product. Refer to the Cable/Set-Top-Box user manual for the SAMSUNG product code.</p>
Anynet+ (HDMI-CEC)	
Anynet+ does not work.	<p>Check if the device is an Anynet+ device. The Anynet+ system supports Anynet+ devices only.</p> <p>You can connect only one receiver (home theatre).</p> <p>Check if the Anynet+ device power cord is properly connected.</p> <p>Check the Anynet+ device's Video/Audio/HDMI cable connections.</p> <p>Check whether Anynet+ (HDMI-CEC) is set to On in the Anynet+ setup menu.</p> <p>Check whether the product remote control is in product mode.</p> <p>Check whether the remote control is Anynet+ compatible.</p> <p>Anynet+ doesn't work in certain situations. (Searching channels, operating Setup, etc.)</p> <p>If you have removed and then reconnected the HDMI cable, please make sure to search devices again or turn your product off and on again.</p>
I want to start Anynet+.	<p>Check if the Anynet+ device is properly connected to the product and check if the Anynet+ (HDMI-CEC) is set to On. (System → Anynet+ (HDMI-CEC))</p> <p>Open the Tools menu using your remote and then select Anynet+ (HDMI-CEC). Then select a menu you want.</p>
I want to exit Anynet+.	<p>Select View TV in the Anynet+ menu.</p> <p>Go to Source screen using your remote and select a non-Anynet+ device.</p>
The message Connecting to Anynet+ device ... appears on the screen.	<p>You cannot use the remote control when you are configuring Anynet+ or switching to a view mode.</p> <p>Use the remote control after the product has completed Anynet+ configuration or has finished switching to Anynet+.</p>

Other Information

Issues	Solutions and Explanations
The Anynet+ device does not play.	You cannot use the play function when Setup is in progress.
The connected device is not displayed.	Check whether or not the device supports Anynet+ functions. Check whether or not the HDMI cable is properly connected. Check whether Anynet+ (HDMI-CEC) is set to On . (System → Anynet+ (HDMI-CEC)) Search Anynet+ devices again. Anynet+ requires an HDMI connection. Make sure the device is connected to your product with an HDMI cable. Some HDMI cables may not support Anynet+ functions. If the connection is terminated because there has been a power failure or the HDMI cable has been disconnected, please repeat the device scan.

-  Some functions and pictures shown in this manual are available on specific models only.
-  To keep your product in optimum condition, upgrade to the latest firmware on the Samsung web site by USB (samsung.com → Support → Downloads).

Supported Subtitle and Media Play file formats

Subtitle

External

- MPEG-4 timed text (.ttx)
- SAMI (.smi)
- SubRip (.srt)
- SubViewer (.sub)
- Micro DVD (.sub or .txt)
- SubStation Alpha (.ssa)
- Advanced SubStation Alpha (.ass)
- Powerdivx (.psb)

Internal

- **Xsub**
Container: AVI
- **SubStation Alpha**
Container: MKV
- **Advanced SubStation Alpha**
Container: MKV
- **SubRip**
Container: MKV
- **MPEG-4 Timed text**
Container: MP4

Supported image resolutions

File Extension	Type	Resolution
*.jpg, *.jpeg	JPG	15360 x 8640
*.bmp	BMP	4096 x 4096
*.mpo	MPO	15360 x 8640

 CMYK, YCKK Colour space JPEG are not supported.

Other Information

Supported music file formats

File Extension	Type	Codec	Comments
*.mp3	MPEG	MPEG1 Audio Layer 3	
*.m4a *.mpa *.aac	MPEG4	AAC	
*.flac	FLAC	FLAC	Supports up to 2 channel
*.ogg	OGG	Vorbis	Supports up to 2 channel
*.wma	WMA	WMA	WMA 10 Pro supports up to 5.1 channel and M2 profile. (WMA lossless audio is not supported.)
*.wav	wav	wav	
*.mid *.midi	midi	midi	The Seek (jump) function is not supported. type 0 and type 1

Video Codec

File Extension	Container	Video Codec	Resolution	Frame rate (fps)	Bit rate (Mbps)	Audio Codec
*.avi *.mkv *.asf *.wmv *.mp4 *.3gp *.vro *.mpg *.mpeg *.ts *.tp *.trp *.mov *.flv *.vob *.svi *.divx	AVI MKV ASF MP4 3GP VRO VOB PS TS	Divx 3.11 / 4 / 5 / 6 MPEG4 SP / ASP H.264 BP / MP / HP HEVC (H.265 - Main, Main10 - L4, L4.1) (for Italy) Motion JPEG Window Media Video v9 MPEG2 MPEG1	1920 x 1080 640 x 480 1920 x 1080	6~30	30 8 30	Dolby Digital LPCM ADPCM(IMA, MS) AAC HE-AAC WMA Dolby Digital Plus MPEG(MP3) DTS (Core) G.711(A-Law, μ -Law)

Other Information

Other Restriction

- ✎ Video content will not play, or not play correctly, if there is an error in the content or the container.
- ✎ Sound or video may not work if the contents have a standard bit rate/frame rate above the compatible Frame/sec listed in the table above.
- ✎ If the Index Table is in error, the Seek (Jump) function is not supported.
- ✎ The menu may take longer to appear if the video's bit rate exceeds 10Mbps.
- ✎ Some USB/digital camera devices may not be compatible with the player.
- ✎ HEVC codec is only available in MKV/MP4/TS containers.(for Italy)

Video Decoders

- Supports up to H.264, Level 4.1 (does not support FMO/ASO/RS)
- Supports up to H.265 - Main, Main10 - L4, L4.1 (for Italy)
- VC1 AP L4 is not supported.
- GMC 2 is not supported.
- Frame speed:
Below 1280x720: 60 frame max
Above 1280x720: 30 frame max







Audio Decoders

- WMA10 Pro supports up to 5.1 channels. Supports up to M2 profile.
- WMA lossless audio is not supported.
- Vorbis is supported for up to 2 channels.
- Dolby Digital Plus is supported for up to 5.1 channels.





Analogue Channel Teletext Feature

The index page of the Teletext service gives you information on how to use the service. For Teletext information to be displayed correctly, channel reception must be stable. Otherwise, information may be missing or some pages may not be displayed.

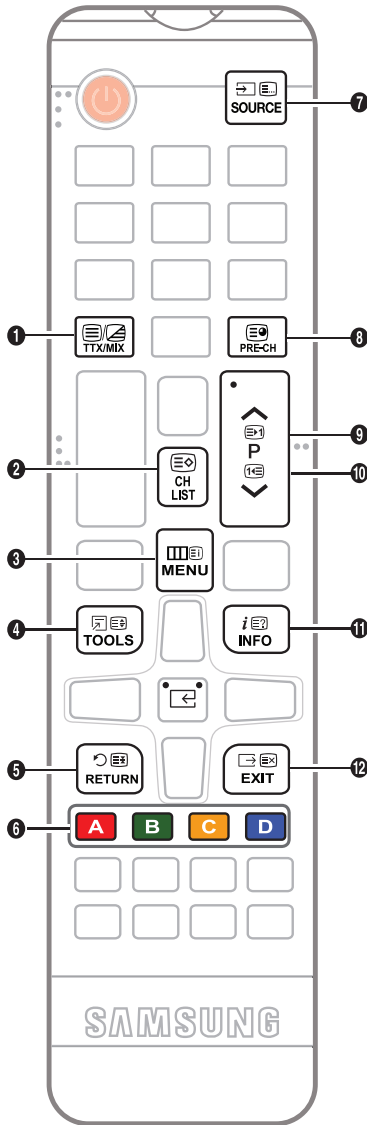
 You can change Teletext pages by pressing the numeric buttons on the remote control.

- 1  (Teletext on/mix/off): Activates the Teletext mode for the current channel. Press the button twice to overlap the Teletext mode with the current broadcasting screen. Press it one more time to exit teletext.
- 2  (store): Stores the Teletext pages.
- 3  (index): Displays the index (contents) page at any time while you are viewing Teletext.
- 4  (size): Displays the teletext on the upper half of the screen in double-size. To move the text to the lower half of the screen, press it again. For normal display, press it once again.
- 5  (hold): Holds the display at the current page, in the case that there are several secondary pages that follow automatically. To undo, press it again.
- 6 Colour buttons (red, green, yellow, blue): If the FASTEXT system is used by the broadcasting company, the different topics on a Teletext page are colour-coded and can be selected by pressing the coloured buttons. Press the colour corresponding to the topic of your choice. A new colour-coded page is displayed. Items can be selected in the same way. To display the previous or next page, press the corresponding coloured button.
- 7  (mode): Selects the Teletext mode (LIST/ FLOF). If pressed during LIST mode, switches the mode to List save mode. In List save mode, you can save a Teletext page into a list using the 8(store) button.



- 8  (sub-page): Displays the available sub-page.
- 9  (page up): Displays the next Teletext page.
- 10  (page down): Displays the previous Teletext page.
- 11  (reveal): Displays the hidden text (answers to quiz games, for example). To display the normal screen, press it again.
- 12  (cancel): Shrinks the Teletext display to overlap with the current broadcast.

Typical Teletext page

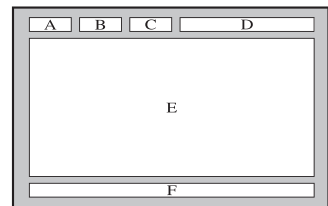

Part	Contents
A	Selected page number.
B	Broadcasting channel identity.
C	Current page number or search indications.
D	Date and time.
E	Text.
F	Status information. FASTEXT information.

Attaching a Wall Mount/Desktop Stand

Preparing before installing Wall-Mount / Desktop Stand

1. Turn the product off and unplug the power cord from the wall outlet.
2. Place a soft cloth or cushion on a flat surface to protect the panel and place the product face down.
3. Hold the main body of the product with your hand. Pull the stand in the direction of the arrow as shown in the figure to separate it.

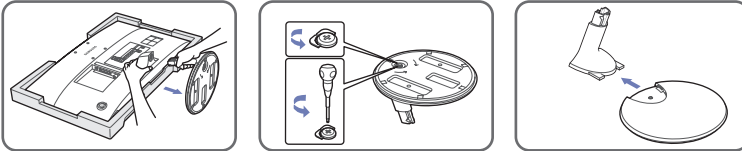

Attaching a Wall Mount / Desktop Stand

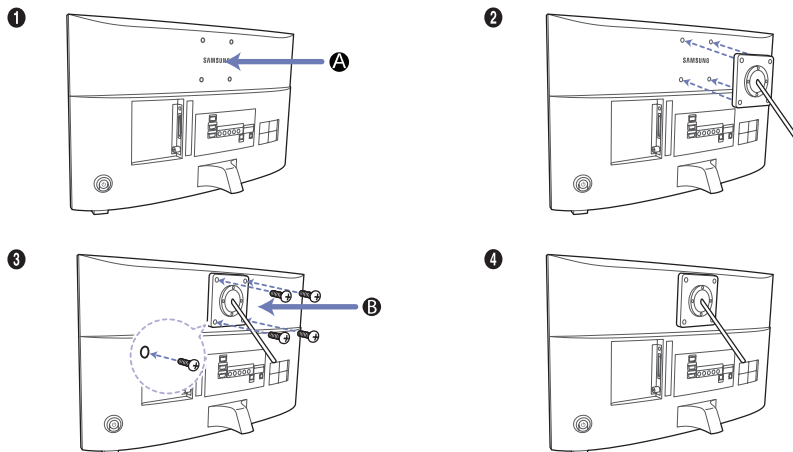

- A Wall/Desktop Stand Mount
- B Wall mount kit/desktop stand (not supplied)

Other Information

⚠ Caution

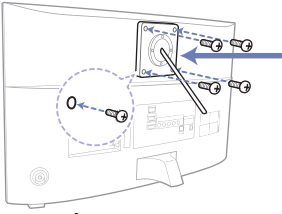

Important

For the installation of Wall-mount, please don't use screws longer than 10 mm (L10) of longitude.

1. Align wall mount/desktop stand to the product and firmly fix the wall mount/desktop stand by fastening the screw.
2. Align the groove of the part of the product that is to be connected to the stand with the groove in the stand (desktop stand, wall mount stand or another stand) and firmly fix the stand by fastening the screw.

Installing the Wall Mount

Installing the Wall Mount Kit

The wall mount kit (sold separately) allows you to mount the TV on the wall.

For detailed information on installing the wall mount, see the instructions provided with the wall mount. Contact a technician for assistance when installing the wall mount bracket. We do not advise you to do it yourself.

Samsung Electronics is not responsible for any damage to the product or injury to yourself or others if you elect to install the TV on your own.

Wall Mount Kit Specifications (VESA)

 The wall mount kit is not supplied, but sold separately.

Install your wall mount on a solid wall perpendicular to the floor. When attaching to other building materials, please contact your nearest dealer. If installed on a ceiling or slanted wall, it may fall and result in severe personal injury.

NOTE

- Standard dimensions for wall mount kits are shown in the table below.
- When purchasing our wall mount kit, a detailed installation manual and all parts necessary for assembly are provided.
- Do not use screws that do not comply with the VESA standard screw specifications.
- Do not use screws that are longer than the standard dimension or do not comply with the VESA standard screw specifications. Screws that are too long may cause damage to the inside of the TV set.
- For wall mounts that do not comply with the VESA standard screw specifications, the length of the screws may differ depending on the wall mount specifications.
- Do not fasten the screws that are too strongly; this may damage the product or cause the product to fall, leading to personal injury. Samsung is not liable for these kinds of accidents.
- Samsung is not liable for product damage or personal injury when a non-VESA or non-specified wall mount is used or the consumer fails to follow the product installation instructions.
- Do not mount the TV at more than a 15 degree tilt.

Product Family	inches	VESA Spec. (A * B)	Standard Screw	Quantity
VF390	27	75.0 x 75.0	M4	4
	31.5			

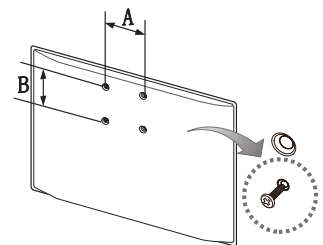

Do not install your Wall Mount Kit while your TV is turned on. It may result in personal injury due to electric shock.

Anti-theft Kensington Lock

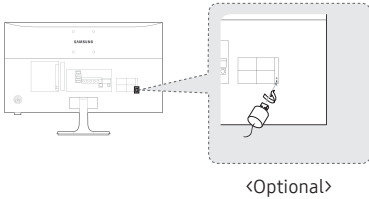

A Kensington Lock is a device you can use to physically fix your product in place when using it in a public place. You wrap the Kensington Lock's cable around a large, immobile object and then attach the lock to the Kensington slot on the back of the product.

The appearance and locking method may differ from the illustration below depending on the manufacturer. Refer to the manual provided with the Kensington Lock for additional information on proper use. The Kensington Lock is not supplied by Samsung.



 Please find a “” icon on the rear of the product. The Kensington slot is beside the “” icon.

To lock the product, follow these steps:

1. Wrap the Kensington Lock cable around a large, stationary object such as desk or chair.
 2. Slide the end of the cable with the lock attached through the looped end of the Kensington Lock cable.
 3. Insert the locking device into the Kensington slot on the product.
 4. Lock the lock.
-  These are general instructions. For exact instructions, see the User manual supplied with the locking device.
-  The locking device has to be purchased separately.
-  The location of the Kensington slot may be different depending on the product model.

Storage and Maintenance

If a sticker was attached to the product screen, some debris can remain after you remove the sticker. Please clean the debris off before watching product.

The exterior and screen of the product can get scratched during cleaning. Be sure to wipe the exterior and screen carefully using a soft cloth to prevent scratches.

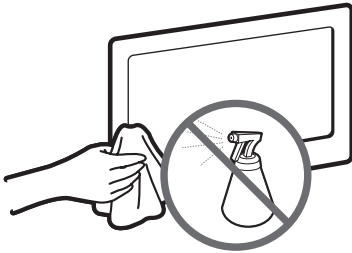

Do not spray water directly onto the product. Any liquid that goes into the product may cause a failure, fire, or electric shock.

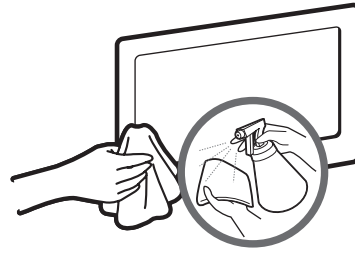

Clean the product with a soft cloth dampened with a small amount of water. Do not use a flammable liquid (e.g. benzene, thinners) or a cleaning agent.

Licence



Manufactured under License from Dolby Laboratories.

Dolby and the double-D symbol are trademarks of Dolby Laboratories.



For DTS patents, see <http://patents.dts.com>. Manufactured under license from DTS, Inc. DTS, the Symbol, DTS in combination with the Symbol, DTS Premium Sound, DTS Digital Surround, and DTS Express are registered trademarks or trademarks of DTS, Inc. in the United States and/or other countries. © DTS, Inc. All Rights Reserved.



For DTS patents, see <http://patents.dts.com>. Manufactured under license from DTS Licensing Limited. DTS, the Symbol, DTS in combination with the Symbol, and DTS Studio Sound are registered trademarks or trademarks of DTS, Inc. in the United States and/or other countries. © DTS, Inc. All Rights Reserved.



The terms HDMI and HDMI High-Definition Multimedia Interface, and the HDMI Logo are trademarks or registered trademarks of HDMI Licensing LLC in the United States and other countries.



This DivX Certified® device has passed rigorous testing to ensure it plays DivX® video.

To play purchased DivX movies, first register your device at vod.divx.com. Find your registration code in the DivX VOD section of your device setup menu.

DivX Certified® to play DivX® video up to HD 1080p, including premium content.

DivX®, DivX Certified® and associated logos are trademarks of DivX, LLC and are used under license.

Covered by one or more of the following U.S. patents: 7,295,673; 7,460,668; 7,515,710; 8,656,183; 8,731,369; RE45,052.

Open Source License Notice

Open Source used in this product can be found on the following webpage. (<http://opensource.samsung.com>)

Open Source License Notice is written only English.



Correct Disposal of This Product (Waste Electrical & Electronic Equipment)

(Applicable in the European Union and other European countries with separate collection systems)

This marking on the product, accessories or literature indicates that the product and its electronic accessories (e.g. charger, headset, USB cable) should not be disposed of with other household waste at the end of their working life. To prevent possible harm to the environment or human health from uncontrolled waste disposal, please separate these items from other types of waste and recycle them responsibly to promote the sustainable reuse of material resources. Household users should contact either the retailer where they purchased this product, or their local government office, for details of where and how they can take these items for environmentally safe recycling. Business users should contact their supplier and check the terms and conditions of the purchase contract. This product and its electronic accessories should not be mixed with other commercial wastes for disposal.



Correct disposal of batteries in this product

(Applicable in the European Union and other European countries with separate battery return systems)

This marking on the battery, manual or packaging indicates that the batteries in this product should not be disposed of with other household waste at the end of their working life. Where marked, the chemical symbols Hg, Cd or Pb indicate that the battery contains mercury, cadmium or lead above the reference levels in EC Directive 2006/66. If batteries are not properly disposed of, these substances can cause harm to human health or the environment. To protect natural resources and to promote material reuse, please separate batteries from other types of waste and recycle them through your local, free battery return system.

For information on Samsung's environmental commitments and product-specific regulatory obligations, e.g. REACH, WEEE, Batteries, visit http://www.samsung.com/uk/aboutsamsung/samsungelectronics/corporatecitizenship/data_corner.html

WARNING - TO PREVENT THE SPREAD OF FIRE, KEEP CANDLES OR OTHER ITEMS WITH OPEN FLAMES AWAY FROM THIS PRODUCT AT ALL TIMES.



Specifications

Environmental considerations	Operating	Temperature: 10°C ~ 40°C Humidity: 10 % ~ 80 %, non-condensing
	Storage	Temperature: -20°C ~ 45°C Humidity: 5 % ~ 95 %, non-condensing
Tilt		VF390: -1.0° (±1.0°) ~ 22.0° (±2.0°)
Model Name		V27F390FE*
Screen Size (Diagonal)		27.0 inches (68.6 cm)
Display Resolution		1920 x 1080@60Hz
Sound (Output)		5W x 2
Dimensions (W x H x D)	Body	622.9 x 367.6 x 29.5 mm
	With stand	622.9 x 462.6 x 247.7 mm
Weight	Body	3.9 kg
	With stand	4.7 kg
Model Name		V32F390FE*
Screen Size (Diagonal)		31.5 inches (80.1 cm)
Display Resolution		1920 x 1080@60Hz
Sound (Output)		5W x 2
Dimensions (W x H x D)	Body	724.3 x 428.0 x 30.4 mm
	With stand	724.3 x 519.1 x 247.7 mm
Weight	Body	5.5 kg
	With stand	6.3 kg

- ✎ Design and specifications are subject to change without prior notice.
- ✎ For information about power supply, and more about power consumption, refer to the label attached to the product.
- ✎ Some models may not be available for purchase depending on the region.
- ✎ If there is no power cut-off switch, the power consumption is "0" only when the power cord is disconnected.
- ✎ DPM(Display Power Management) Function does not work if you used in conjunction with the **HDMI IN 1 (DVI)** port of this product.
- ✎ Typical power consumption is measured according to IEC 62087.

Index

A

Advanced Settings	36
Aerial	41
Anti-theft Kensington Lock	86
Anynet+ (HDMI-CEC)	69
Audio Format	50
Auto Power Off	54
Auto Tuning	41
Auto Volume	40

B

Backlight	31
Black Tone	36
Brightness	31

C

Change PIN	55
Channel List	43
Colour	31
Colour Space	36
Colour Tone	37
Contact Samsung	59
Contrast	31

D

Digital Clean View	37
DivX® Video On Demand	57
Dynamic Contrast	36

E

Eco Solution	54
Energy Saving	54
Entertain	30
Equaliser	39

F

Film Mode	37
Fine Tune	49
Flesh Tone	36
FreeSync	67

G

Game Mode	56
Gamma	36
General	56

H

HDMI Black Level	37
------------------	----

L

LED Clear Motion	37
Licence	88

M

Media Play	61
Menu Language	56
Motion Lighting	36
MPEG Noise Filter	37
Music playback	66

N

No Signal Power Off	54
---------------------	----

O

Off Timer	53
On Timer	53

P

Panel Lock	56
Photo Playback	64
Picture Mode	30
Picture Options	37
Picture Size	32
Picture Test	58
PIP	35
Programme Rating Lock	55

R

Reset Picture	38
Reset Sound	40
RGB Only Mode	36

S

Schedule Manager	45
Self Diagnosis	58
Setting up Anynet+ (HDMI-CEC)	70
Sharpness	31
Signal Information	58
Sleep Timer	52
Software Update	59
Sound Effect	39
Sound Mode	38
Sound Test	58
Speaker Settings	40
Supported music file formats	80
Supported Subtitle and Media Play file formats	79

T

Time	52
Tint (G/R)	31
Troubleshooting	72

V

Video Codec	80
Video Playback	62

W

White Balance	36
---------------	----

Warranty Card



United Kingdom



Republic of Ireland (EIRE)

This Samsung product is warranted for a period of twelve (12) months from the original date of purchase, against defective materials and workmanship. In the event that warranty service is required, you should return the product to the retailer from whom it was purchased. However, Samsung Authorised Dealers and Authorised Service Centres in other EC Countries will comply with the warranty on the terms issued to purchasers in the country concerned. In case of difficulty, details of our Authorised Service Centres are available from:

Samsung Electronics U.K. Ltd.

Customer Care Centre

PO Box 479

GATESHEAD NE9 9BJ

United Kingdom

Tel: 0330 SAMSUNG (7267864) / Fax: 0330 7260001 (UK & Northern Ireland)

Tel: 0818 717100 / Fax: +44 117 915 6736 (EIRE Only)

Web: www.samsung.com

WARRANTY CONDITIONS

1. The warranty is only valid if, when warranty service is required, the warranty card is fully and properly completed and is presented with the original invoice or sales slip or confirmation, and the serial number on the product has not been defaced.
2. Samsung's obligations are limited to the repair or, at its discretion, replacement of the product or the defective part.
3. Warranty repairs must be carried out by Authorised Samsung Dealers or Authorised Service Centres. No reimbursement will be made for repairs carried out by non Samsung Dealers and, any such repair work and damage to the products caused by such repair work will not be covered by this warranty.
4. This product is not considered to be defective in materials nor workmanship by reason that it requires adaptation in order to conform to national or local technical or safety standards in force in any country other than the one for which the product was originally designed and manufactured.
5. This warranty covers none of the following:
 - a) Periodic check ups, maintenance and repair or replacement of parts due to normal wear and tear.
 - b) Cost relating to transport, removal or installation of the product.
 - c) Misuse, including the failure to use this product for its normal purposes or incorrect installation.
 - d) Damage caused by Lightning, Water, Fire, Acts of God, War, Public Disturbances, incorrect mains voltage, improper ventilation or any other cause beyond the control of Samsung.
 - e) Spillage of food or liquid or use of any other hazardous substances, which may effect the product.
 - f) Performance due to differences in broadcasting method between countries
7. This warranty is valid for any person who legally acquired possession of the product during the warranty period.
8. The consumers statutory rights in any applicable national legislation whether against the retailer arising from the purchase contract or otherwise are not affected by this warranty. Unless there is national legislation to the contrary, the rights under this warranty are the consumers sole rights and Samsung, its subsidiaries and distributors shall not be liable for indirect or consequential loss or any damage to records, compact discs, videos or audio taper or any other related equipment or material.
9. Some products may differ from these guidelines. Please check with your dealer or the local Samsung web-site.

Wiring the Mains Power Supply Plug (UK Only)

IMPORTANT NOTICE

The mains lead on this equipment is supplied with a moulded plug incorporating a fuse. The value of the fuse is indicated on the pin face of the plug and, if it requires replacing, a fuse approved to BS11362 of the same rating must be used.

Never use the plug with the fuse cover omitted if the cover is detachable. If a replacement fuse cover is required, it must be of the same colour as the pin face of the plug. Replacement covers are available from your dealer.

If the fitted plug is not suitable for the power points in your house or the cable is not long enough to reach a power point, you should obtain a suitably approved extension lead or consult your dealer for assistance. However, if there is no alternative but to cut off the plug, remove the fuse and then safely dispose of the plug.

Do NOT connect the plug to a mains socket as there is a risk of shock hazard from the bared flexible cord.

IMPORTANT

The wires in the mains lead are coloured in accordance with the following code:

BLUE - NEUTRAL BROWN - LIVE

As these colours may not correspond to the coloured markings identifying the terminals in your plug, proceed as follows : The wire coloured BLUE must be connected to the terminal marked with the letter N or coloured BLUE or BLACK. The wire coloured BROWN must be connected to the terminal marked with the letter L or coloured BROWN or RED.

WARNING

DO NOT CONNECT EITHER WIRE TO THE EARTH TERMINAL, WHICH IS MARKED WITH THE LETTER E OR BY THE EARTH SYMBOL, OR COLOURED GREEN OR GREEN AND YELLOW.

Adaptor information

 Use following adaptor to avoid hazard

Manufacturer : SAMSUNG

Adaptor model : A4514N_DSM ; A4514_DSM ; A3514_ESM

Manufacturer : SOLUM

Adaptor model : A4514N_DSM ; A4514_DSM ; A3514_ESM

Manufacturer : Powernet

Adaptor model : A3514_FPN ; A4514_FPN

To reduce the risk of fire or electric shock, do not expose this apparatus to rain or moisture.

Apparatus shall not be exposed to dripping or splashing and no objects filled with liquids, such as vases, shall not be placed on the apparatus.

For power cord use, see user manual.

ATENCION: SOLO PARA USO EN INTERIORES

SAMSUNG

Contact SAMSUNG WORLD WIDE

If you have any questions or comments relating to Samsung products, please contact the SAMSUNG customer care centre.

Area	Customer Care Centre ☎	Web Site
AUSTRIA	0800-SAMSUNG (0800-7267864) [Only for Dealers] 0810-112233	www.samsung.com/at/support
BELGIUM	02-201-24-18	www.samsung.com/be/support (Dutch) www.samsung.com/be_fr/support (French)
BOSNIA	055 233 999	www.samsung.com/support
BULGARIA	*3000 Цена в мрежата 0800 111 31, Безплатна телефонна линия	www.samsung.com/bg/support
CROATIA	072 726 786	www.samsung.com/hr/support
CZECH	800 - SAMSUNG (800-726786) Samsung Electronics Czech and Slovak, s.r.o. V Parku 2323/14, 148 00 - Praha 4	www.samsung.com/cz/support
DENMARK	70 70 19 70	www.samsung.com/dk/support
EIRE	0818 717100	www.samsung.com/ie/support
ESTONIA	800-7267	www.samsung.com/ee/support
FINLAND	030-6227 515	www.samsung.com/fi/support
FRANCE	01 48 63 00 00	www.samsung.com/fr/support
GERMANY	0180 6 SAMSUNG bzw. 0180 6 7267864* (*0,20 €/Anruf aus dem dt. Festnetz, aus dem Mobilfunk max. 0,60 €/Anruf)	www.samsung.com/de/support
CYPRUS	8009 4000 only from landline, toll free	www.samsung.com/gr/support
GREECE	80111-SAMSUNG (80111 726 7864) only from land line (+30) 210 6897691 from mobile and land line	
HUNGARY	0680SAMSUNG (0680-726-786) 0680PREMIUM (0680-773-648)	http://www.samsung.com/hu/support
ITALIA	800-SAMSUNG (800.7267864)	www.samsung.com/it/support
LATVIA	8000-7267	www.samsung.com/lv/support
LITHUANIA	8-800-77777	www.samsung.com/lt/support
LUXEMBURG	261 03 710	www.samsung.com/be_fr/support
MONTENEGRO	020 405 888	www.samsung.com/support
NETHERLANDS	0900-SAMSUNG (0900-7267864) (€ 0,10/Min)	www.samsung.com/nl/support
NORWAY	815 56480	www.samsung.com/no/support
POLAND	801-172-678* lub +48 22 607-93-33* * (koszt połączenia według taryfy operatora)	www.samsung.com/pl/support
PORTUGAL	808 20 7267	www.samsung.com/pt/support
ROMANIA	*8000 (apel in retea) 08008-726-78-64 (08008-SAMSUNG) Apel GRATUIT	www.samsung.com/ro/support
SERBIA	011 321 6899	www.samsung.com/rs/support
SLOVAKIA	0800 - SAMSUNG (0800-726 786)	www.samsung.com/sk/support
SLOVENIA	080 697 267 (brezplačna številka)	www.samsung.com/si
SPAIN	34902172678	www.samsung.com/es/support
SWEDEN	0771 726 7864 (0771-SAMSUNG)	www.samsung.com/se/support
SWITZERLAND	0800 726 78 64 (0800-SAMSUNG)	www.samsung.com/ch/support (German) www.samsung.com/ch_fr/support (French)
UK	0330 SAMSUNG (7267864)	www.samsung.com/uk/support
TURKEY	444 77 11	www.samsung.com/tr/support