

**SAMSUNG**

# User Manual

---

U32J590UQ\* U32J592UQ\*

The color and the appearance may differ depending on the product, and the specifications are subject to change without prior notice to improve the performance.

The contents of this manual are subject to change without notice to improve quality.

© Samsung Electronics

Samsung Electronics owns the copyright for this manual.

Use or reproduction of this manual in parts or entirety without the authorization of Samsung Electronics is prohibited.

Trademarks other than that of Samsung Electronics are owned by their respective owners.

---

(For India Only)

This product is RoHS compliant.

For more information on safe disposal and recycling visit our website [www.samsung.com/in](http://www.samsung.com/in) or contact our Helpline numbers- 1800 40 SAMSUNG (1800 40 7267864) (Toll-Free)

---

---

# Table of contents

## Before Using the Product

---

Securing the Installation Space	4
Precautions for storage	4
<b>Safety Precautions</b>	<b>4</b>
Cleaning	5
Electricity and Safety	5
Installation	6
Operation	7

## Preparations

---

<b>Parts</b>	<b>10</b>
Control Panel	10
Direct Key guide	11
Function Key Guide	12
Configuring Eye Saver Mode, Brightness and Contrast from the Initial Screen	14
Changing the Volume setting	14
Types of Ports	15
Adjusting the Product Tilt	16
Anti-theft Lock	16
Precautions for moving the monitor	17
Installing a Wall-mount Kit or Desktop Stand	18
<b>Installation</b>	<b>19</b>
Attaching the Stand	19
Removing the Stand	20

## Connecting and Using a Source Device

---

Read below before installing the monitor.	21
<b>Connecting and Using a PC</b>	<b>21</b>
Connection Using the HDMI Cable	21
Connection Using the HDMI-DVI Cable	22
Connection Using the DP Cable	22
Connecting to Headphones	22
Connecting the Power	23
<b>Correct posture to use the product</b>	<b>24</b>
<b>Driver Installation</b>	<b>24</b>
<b>Setting Optimum Resolution</b>	<b>24</b>

## Screen Setup

---

SAMSUNG MAGIC Bright	25
Brightness	26
Contrast	26
Sharpness	26
Color	26
HDMI Black Level	27
Eye Saver Mode	27
Game Mode	27
Response Time	27
Picture Size	28
Screen Adjustment	28

---

# Table of contents

## Configuring the PIP/PBP Settings

PIP/PBP Mode	29
Size	30
Position	30
Sound Source	30
Source	31
Picture Size	31
Contrast	32

## Adjusting OSD (On Screen Display) settings

Transparency	33
Language	33
Display Time	33

## Setup and Reset

FreeSync	34
Eco Saving Plus	36
Off Timer Plus	36
PC/AV Mode	37
DisplayPort Ver.	37
Source Detection	37
Key Repeat Time	37
Power LED On	37
Reset All	37
Information	38

## Installing the Software

Easy Setting Box	39
Restrictions and Problems with the Installation	39
System Requirements	39

## Troubleshooting Guide

Requirements Before Contacting Samsung Customer Service Center	40
Testing the Product	40
Checking the Resolution and Frequency	40
Check the following.	40
Q & A	42

## Specifications

General	43
Standard Signal Mode Table	44

## Appendix

Responsibility for the Pay Service (Cost to Customers)	48
Not a product defect	48
A Product damage caused by customer's fault	48
Others	48

# Chapter 01

## Before Using the Product

### Securing the Installation Space

Ensure some space around the product for ventilation. An internal temperature rise may cause fire and damage the product. Be sure to allow the amount of space as shown below or greater when installing the product.

— The exterior may differ depending on the product.

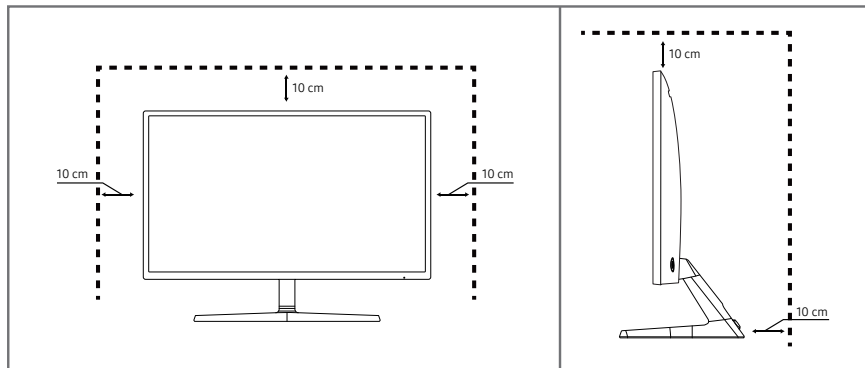

### Precautions for storage

High-glossy models can develop white stains on the surface if an ultrasonic wave humidifier is used nearby.

— Contact your nearest Samsung Customer Service Center if you want to clean the inside of the product (Service fee will be charged.)

Do not press the monitor screen with hands or other objects. There is a risk of damaging the screen.

### Safety Precautions

#### Warning

A serious or fatal injury may result if instructions are not followed.

#### Caution

Personal injury or damage to properties may result if instructions are not followed.

---

## Cleaning

- Exercise care when cleaning as the panel and exterior of advanced LCDs are easily scratched.
  - Take the following steps when cleaning.
- 1 Power off the product and computer.
  - 2 Disconnect the power cord from the product.
    - Hold the power cable by the plug and do not touch the cable with wet hands. Otherwise, an electric shock may result.
  - 3 Wipe the monitor with a clean, soft and dry cloth.
    - Do not apply a cleaning agent that contains alcohol, solvent, or surfactant to the monitor.
    - Do not spray water or detergent directly on the product.
  - 4 Wet a soft and dry cloth in water and wring thoroughly to clean the exterior of the product.
  - 5 Connect the power cord to the product when cleaning is finished.
  - 6 Power on the product and computer.

---

## Electricity and Safety

### Warning

- Do not use a damaged power cord or plug, or a loose power socket.
- Do not use multiple products with a single power socket.
- Do not touch the power plug with wet hands.
- Insert the power plug all the way in so it is not loose.
- Connect the power plug to a grounded power socket (type 1 insulated devices only).
- Do not bend or pull the power cord with force. Be careful not to leave the power cord under a heavy object.
- Do not place the power cord or product near heat sources.
- Clean any dust around the pins of the power plug or the power socket with a dry cloth.

### Caution

- Do not disconnect the power cord while the product is being used.
- Only use the power cord provided with your product by Samsung. Do not use the power cord with other products.
- Keep the power socket where the power cord is connected unobstructed.
  - The power cord must be disconnected to cut off power to the product when an issue occurs.
- Hold the plug when disconnecting the power cord from the power socket.

---

## Installation

### Warning

- DO NOT PLACE CANDLES, INSECT REPELLANTS OR CIGARETTES ON TOP OF THE PRODUCT. DO NOT INSTALL THE PRODUCT NEAR HEAT SOURCES.
- Do not install the product in poorly ventilated spaces such as a bookcase or closet.
- Install the product at least 10 cm away from the wall to allow ventilation.
- Keep the plastic packaging out of the reach of children.
  - Children may suffocate.
- Do not install the product on an unstable or vibrating surface (insecure shelf, sloped surface, etc.)
  - The product may fall and become damaged and/or cause an injury.
  - Using the product in an area with excess vibration may damage the product or cause a fire.
- Do not install the product in a vehicle or a place exposed to dust, moisture (water drips, etc.), oil, or smoke.
- Do not expose the product to direct sunlight, heat, or a hot object such as a stove.
  - The product lifespan may be reduced or a fire may result.
- Do not install the product within the reach of young children.
  - The product may fall and injure children.
- Edible oil (such as soybean oil) may damage or distort the product. Keep the product away from oil pollution. And do not install or use the product in the kitchen or near the kitchen stove.

### Caution

- Do not drop the product while moving.
- Do not set down the product on its front.
- When installing the product on a cabinet or shelf, make sure that the bottom edge of the front of the product is not protruding.
  - The product may fall and become damaged and/or cause an injury.
  - Install the product only on cabinets or shelves of the right size.
- Set down the product gently.
  - Product failure or personal injury may result.
- Installing the product in an unusual place (a place exposed to a lot of fine dust, chemical substances, extreme temperatures or a significant presence of moisture, or a place where the product will operate continuously for an extended period of time) may seriously affect its performance.
  - Be sure to consult Samsung Customer Service Center if you want to install the product at such a place.

---

## Operation

### Warning

- There is a high voltage inside the product. Never disassemble, repair or modify the product yourself.
  - Contact Samsung Customer Service Center for repairs.
- To move the product, first disconnect all the cables from it, including the power cable.
- If the product generates abnormal sounds, a burning smell or smoke, disconnect the power cord immediately and contact Samsung Customer Service Center.
- Do not let children hang from the product or climb on top of it.
  - Children may become injured or seriously harmed.
- If the product is dropped or the outer case is damaged, turn off the power and disconnect the power cord. Then contact Samsung Customer Service Center.
  - Continued use can result in a fire or electric shock.
- Do not leave heavy objects or items that children like (toys, sweets, etc.) on top of the product.
  - The product or heavy objects may fall as children try to reach for the toys or sweets resulting in a serious injury.
- During a lightning or thunderstorm, power off the product and remove the power cable.
- Do not drop objects on the product or apply impact.
- Do not move the product by pulling the power cord or any cable.
- If a gas leakage is found, do not touch the product or power plug. Also, ventilate the area immediately.
- Do not lift or move the product by pulling the power cord or any cable.
- Do not use or keep combustible spray or an inflammable substance near the product.
- Ensure the vents are not blocked by tablecloths or curtains.
  - An increased internal temperature may cause a fire.
- Do not insert metallic objects (chopsticks, coins, hairpins, etc) or objects that burn easily (paper, matches, etc) into the product (via the vent or input/output ports, etc).
  - Be sure to power off the product and disconnect the power cord when water or other foreign substances have entered the product. Then contact Samsung Customer Service Center.
- Do not place objects containing liquid (vases, pots, bottles, etc) or metallic objects on top of the product.
  - Be sure to power off the product and disconnect the power cord when water or other foreign substances have entered the product. Then contact Samsung Customer Service Center.

---

## Caution

- Leaving the screen fixed on a stationary image for an extended period of time may cause afterimage burn-in or defective pixels.
    - Activate power-saving mode or a moving-picture screen saver if you will not be using the product for an extended period of time.
  - Disconnect the power cord from the power socket if you do not plan on using the product for an extended period of time (vacation, etc).
    - Dust accumulation combined with heat can cause a fire, electric shock or electric leakage.
  - Use the product at the recommended resolution and frequency.
    - Your eyesight may deteriorate.
  - Do not put AC/DC adapters together.
  - Remove the plastic bag from the AC/DC adapter before you use it.
  - Do not let water enter the AC/DC adapter device or get the device wet.
    - An electric shock or fire may result.
    - Avoid using the product outdoors where it can be exposed to rain or snow.
    - Be careful not to get the AC/DC adapter wet when you wash the floor.
  - Do not put the AC/DC adapter near to any heating apparatus.
    - Otherwise, a fire may result.
  - Keep the AC/DC adapter in a well-ventilated area.
  - If you place the AC/DC power adapter so that it is hanging with the cord input facing upwards, water or other foreign substances could enter the Adapter and cause the Adapter to malfunction. Make sure to rest the AC/DC power adapter flat on a table or the floor.
- Insert the power plug into the AC/DC adapter until a click sound is heard.
  - Do not insert only the power plug into the power outlet.
  - Do not use an AC/DC adapter other than the provided one.
    - It may cause electric shock or fire.
  - Do not insert the AC/DC adapter into the power outlet on the ceiling.
    - It may cause electric shock or fire.
  - Rotate the power plug not to exceed the range (0 to 90°) on the AC/DC adapter.
    - It may cause electric shock or fire.
  - Never disassemble the power plug after being assembled. (It cannot be separated after assembly.)
  - Never use the provided power plug for other devices.
  - When removing the AC/DC adapter from the power outlet, hold the body of AC/DC adapter and pull it up.
    - It may cause electric shock or fire.
  - Do not drop any objects or apply shock on the AC/DC adapter.
    - It may cause electric shock or fire.
  - Use the AC/DC adapter after removing its plastic cover.
    - Otherwise, this may result fire.



- 
- Do not hold the product upside-down or move it by holding the stand.
    - The product may fall and become damaged or cause an injury.
  - Looking at the screen too close for an extended period of time can deteriorate your eyesight.
  - Do not use humidifiers or stoves around the product.
  - Rest your eyes for more than 5 minutes or look at distance objects for every 1 hour of product use.
  - Do not touch the screen when the product has been turned on for an extended period of time as it will become hot.
  - Store small accessories out of the reach of children.
  - Exercise caution when adjusting the product angle or stand height.
    - Your hand or finger may get stuck and injured.
    - Tilting the product at an excessive angle may cause the product to fall and an injury may result.
  - Do not place heavy objects on the product.
    - Product failure or personal injury may result.
  - When using headphones or earphones, do not turn the volume too high.
    - Having the sound too loud may damage your hearing.

# Chapter 02

## Preparations

### Parts

#### Control Panel

The color and shape of parts may differ from what is shown. Specifications are subject to change without notice to improve quality.

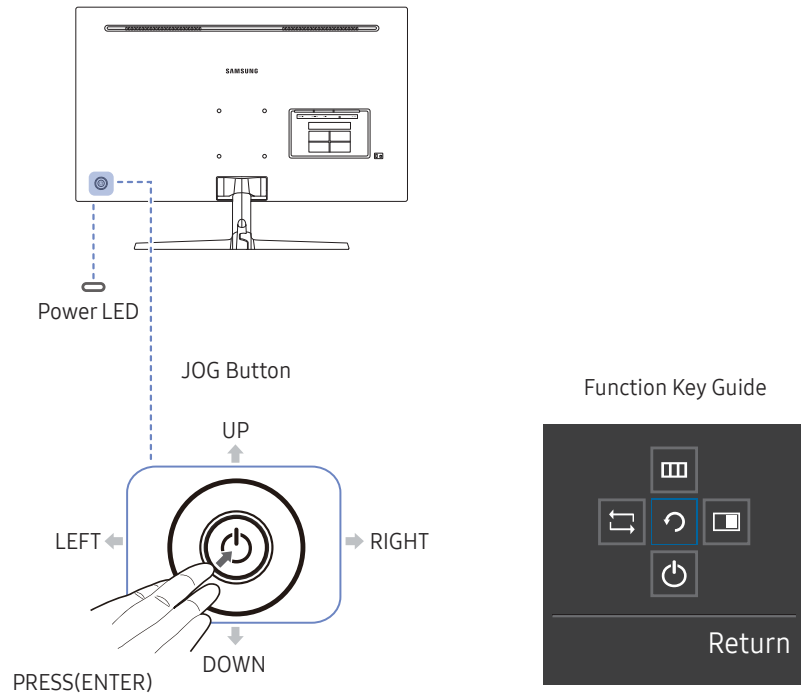

Icons	Description
JOG Button	Multi directional button that helps navigate. The JOG button is located on the rear left side of the product. The button can be used to move up, down, left or right, or as Enter.
Power LED	This LED is power status indicator and works as <ul style="list-style-type: none"><li>Power On (Power button): Off</li><li>Power saving mode: Blinking</li><li>Power Off (Power button): On</li></ul> The power Indicator operation can be swapped by changing in the menu. (System → Power LED On) Actual models because of functional variation maybe haven't this function.
Function Key Guide	Press the JOG button when the screen is turned on. The Function Key Guide will appear. To access the onscreen menu when the guide is displayed, press the corresponding direction button again. Function Key Guide may vary depending on the function or product model. Please refer to the actual product.

---

## Direct Key guide

— The shortcut button screen (OSD menu) shown below is displayed only when the monitor screen is turned on, the computer resolution changes, or the input source changes.

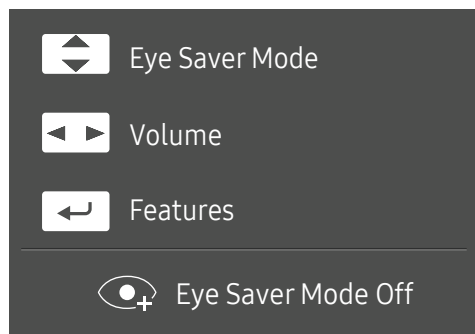

- UP/DOWN: Adjust **Brightness, Contrast, Eye Saver Mode**.
- LEFT/RIGHT: Adjust **Volume**.
- PRESS(ENTER): Display Function Key Guide.





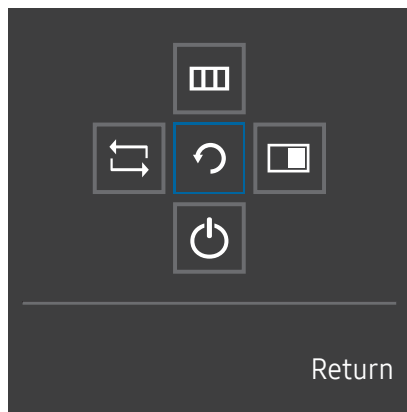



## Function Key Guide

— To enter the main menu or to use other items, press the JOG button to display the Function Key Guide. You can exit by pressing the JOG button again.



UP/DOWN/LEFT/RIGHT: Move to the item you want. The description for each item will appear when the focus changes.

PRESS(ENTER): The selected item will be applied.

Icons	Description
	Selects  to change the input signal by moving the JOG button in the Function Key Guide screen. A message will appear on the top left corner of the screen if the input signal has been changed.
	Selects  by moving the JOG button in the function key guide screen. The OSD (On Screen Display) of your Monitor's feature appears. OSD control lock: Maintain the current settings, or lock the OSD control to prevent unintended changes to settings. Enable/Disable: To lock/unlock the OSD control, press the LEFT button for 10 seconds when the main menu is displayed. — If the OSD control is locked, <b>Brightness</b> and <b>Contrast</b> can be adjusted. <b>PIP/PBP</b> is available. <b>Eye Saver Mode</b> is available. <b>Information</b> can be viewed.
	Selects  by moving the JOG button in the function key guide screen. Press the button when configuring settings for the <b>PIP/PBP</b> function is required.
	Selects  to turn the Monitor off by moving the JOG button in the function key guide screen.

— Actual models because of functional variation, Function key guide options will be different.

---

When the monitor displays nothing (i.e. Power saving mode or Non-signal mode), 2 direct keys for control source and power could be used as below.

JOG Button	Power saving/Non-signal mode
UP	Source Change
Down	
PRESS(ENTER) for 2 seconds	Power Off

When the monitor displays the Main menu the JOG Button could be used as below.

JOG Button	Action
UP/DOWN	Move the option
	Exit the Main menu.
LEFT	Close Sublist without saving value. Value decreases in the slider.
RIGHT	Move to next depth. Value increases in the slider.
PRESS(ENTER)	Move to next depth. Save the value and close Sublist.

---

## Configuring Eye Saver Mode, Brightness and Contrast from the Initial Screen

Adjust the **Brightness**, **Contrast** and **Eye Saver Mode** by moving the JOG button.



- The displayed image may differ depending on the model.
- The default brightness can vary depending on the region.

### Eye Saver Mode

- Not available when **PIP/PBP Mode** is set to **On**.

### Brightness

- This menu is not available when **SAMSUNG MAGICBright** is set to **Dynamic Contrast** mode.
- This menu is not available when **Eco Saving Plus** is enabled.
- This menu is not available when **Eye Saver Mode** is enabled.

### Contrast

- This menu is not available when **SAMSUNG MAGICBright** is in **Cinema** or **Dynamic Contrast** mode.
- This menu is not available when **Game Mode** is enabled.
- This menu is not available when **PIP/PBP Mode** is set to **On** and the **Size** is set to  (PBP Mode).

---

## Changing the Volume setting

You can adjust **Volume** by moving the JOG button left or right, if no OSD menu is displayed.





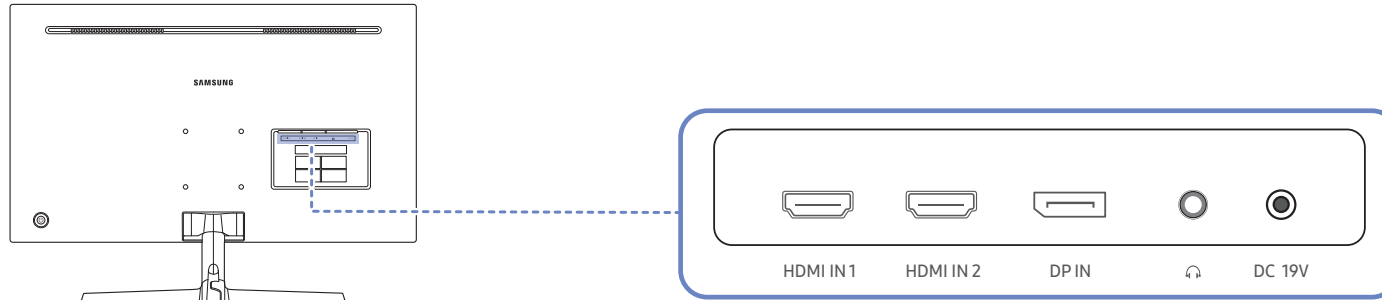

- The displayed image may differ depending on the model.
- If the audio quality of a connected input device is poor, the Auto Mute function on the product may mute the sound or cause choppy audio when applying the headphones or speakers. Set the input volume for the input device to at least 20% and control the volume using the volume control (JOG button LEFT/RIGHT) on the product.
  - What is Auto Mute?
    - The function mutes the audio to improve sound effect when there is sound noise or when the input signal is weak, usually due to a problem with the volume of an input device.
- To activate the **Mute** function, access the **Volume** control screen, then use the JOG button to move the focus down. To deactivate the **Mute** function, access the **Volume** control screen, then increase or decrease the **Volume**.

## Types of Ports

— The functions available may vary depending on the product model. The color and shape of parts may differ from what is shown. Specifications are subject to change without notice to improve quality. Refer to the actual product.



Port	Description
 HDMI IN 1    HDMI IN 2	Connects to a source device using an HDMI cable or HDMI-DVI cable. <ul style="list-style-type: none"><li>— <b>HDMI1</b> support 3840 x 2160 @ 30 Hz</li><li>— <b>HDMI2</b> support 3840 x 2160 @ 60 Hz</li></ul>
 DP IN	Connects to a PC using a DP cable.
	Connect to an audio output device such as headphones. <ul style="list-style-type: none"><li>— The sound could only be heard when using the HDMI to HDMI cable or DP cable.</li></ul>
 DC 19V	Connects to the AC/DC adapter.

## Adjusting the Product Tilt

— The color and shape of parts may differ from what is shown. Specifications are subject to change without notice to improve quality.

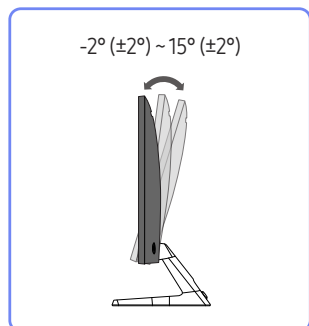

- The monitor tilt can be adjusted.
- Hold the lower part of the product and adjust the tilt carefully.

## Anti-theft Lock

- An anti-theft lock allows you to use the product securely even in public places.
- The locking device shape and locking method depend on the manufacturer. Refer to the user guide provided with your anti-theft locking device for details.

### To lock an anti-theft locking device:

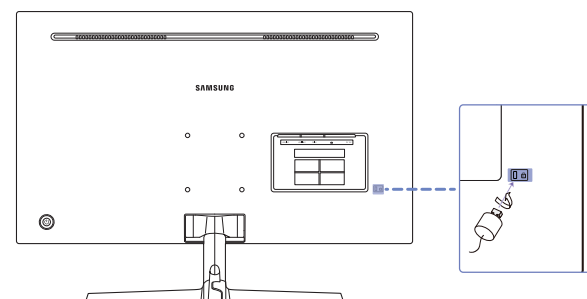

- 1 Fix the cable of your anti-theft locking device to a heavy object such as a desk.
- 2 Put one end of the cable through the loop on the other end.
- 3 Insert the locking device into the anti-theft lock slot at the back of the product.
- 4 Lock the locking device.
  - An anti-theft locking device can be purchased separately.
  - Refer to the user guide provided with your anti-theft locking device for details.
  - Anti-theft locking devices can be purchased at electronics retailers or online.



---

## Precautions for moving the monitor

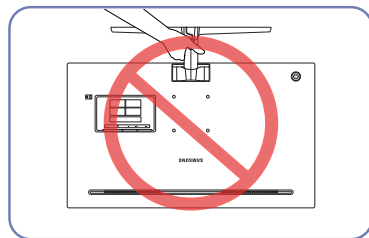
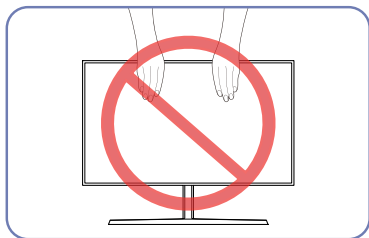

- Do not directly apply pressure on the screen.
- Do not hold the screen when moving the monitor.
- Do not hold the product upside down only by the stand.

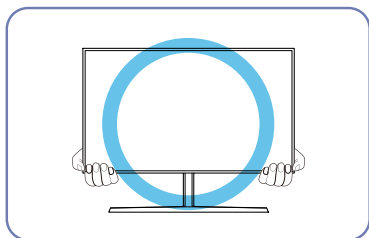

- Hold the lower corners or edges of the monitor when moving it.

## Installing a Wall-mount Kit or Desktop Stand

— Power the product off and remove the power cable from the power socket.

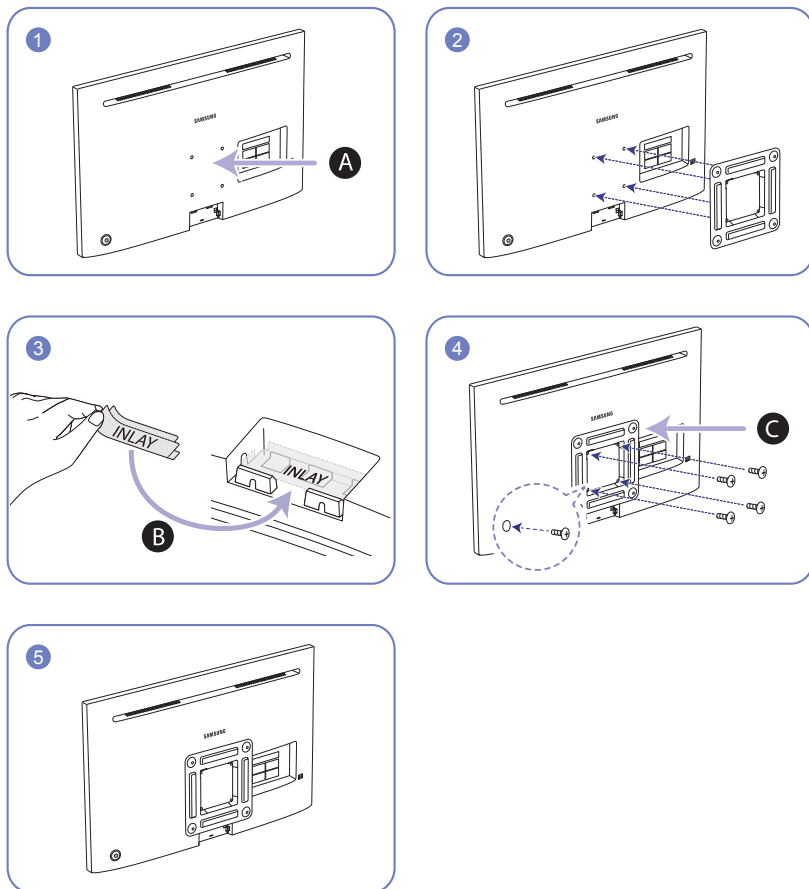

**A** Attach the wall-mount kit or desktop stand here.

**B** Attach the INLAY to the position as shown in the figure.

**C** Bracket (sold separately)

Align the grooves and tightly fasten the screws on the bracket on the product with the corresponding parts on the wall-mount kit or desktop stand you want to attach.

### • Notes

- Using a screw longer than the standard length can damage the internal components of the product.
- The length of screws required for a wall mount that does not comply with the VESA standards may vary depending on the specifications.
- Do not use screws that do not comply with the VESA standards. Do not attach the wall-mount kit or desktop stand using excessive force. The product may get damaged or fall and cause personal injury. Samsung shall not be held liable for any damage or injury caused by using improper screws or attaching the wall-mount kit or desktop stand using excessive force.
- Samsung shall not be held liable for any product damage or personal injury caused by using a wall-mount kit other than the one specified or from an attempt to install the wall-mount kit on your own.
- To mount the product on a wall, ensure you purchase a wall-mount kit that can be installed 10 cm or farther away from the wall.
- Be sure to use a wall-mount kit that complies with the standards.
- To install the monitor using a wall mount, disconnect the stand base from the monitor.

Unit: mm

Model name	VESA screw hole specs (A * B) in millimeters	Standard Screw	Quantity
U32J590UQ* / U32J592UQ*	100.0 x 100.0	4.0 mm $\Phi$ , 0.7 pitch * 10.0 mm long	4 EA

— Do not install your Wall Mount Kit while your product is turned on. It may result in personal injury due to electric shock.

# Installation

## Attaching the Stand

— Before assembling the product, place the product down on a flat and stable surface so that the screen is facing downwards.

— The exterior may differ depending on the product.

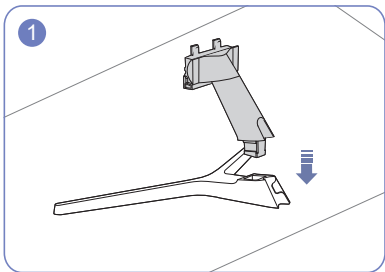

Insert the stand neck into the stand base in the direction shown in the figure.

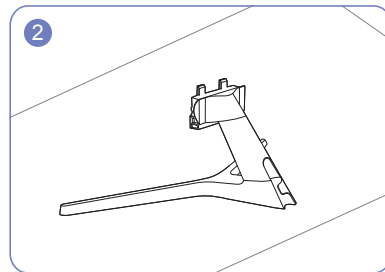

Check that the stand neck is firmly connected.

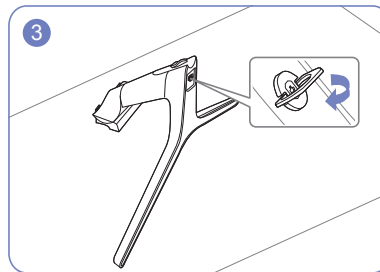

Tightly fasten the connecting screw at the bottom of the stand base.

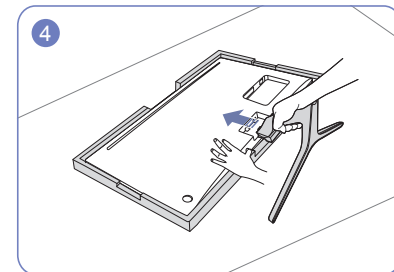

Place the protective Styrofoam (cushion) included in the package on the floor and place the product facing down on the Styrofoam, as shown in the image.

If Styrofoam is unavailable, use a thick sitting mat.

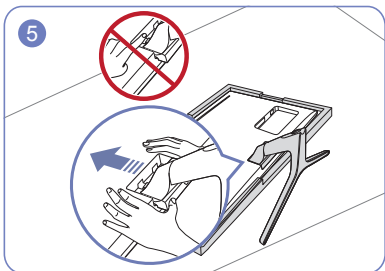

Hold the main body of the product with your hand as shown by the figure. Push the assembled stand into the main body in the direction of the arrow as shown in the figure.

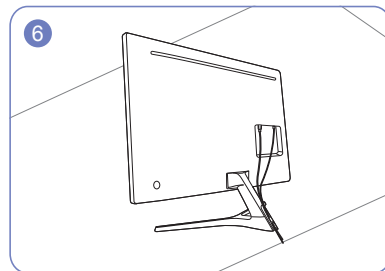

Connect the power supply and the data cable as shown in the figure.



- Caution

Do not press down on the monitor. There is a risk of damaging the monitor.

## Removing the Stand

- Before removing the stand from the monitor, place the monitor on a flat and stable surface with the screen facing down.
- The exterior may differ depending on the product.

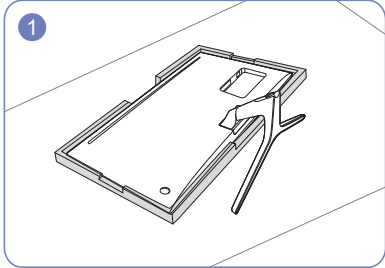

Place the protective Styrofoam (cushion) included in the package on the floor and place the product facing down on the Styrofoam, as shown in the image.

If Styrofoam is unavailable, use a thick sitting mat.

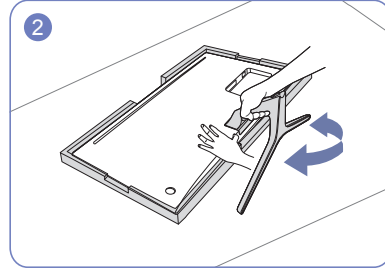

To disassemble the stand from the monitor, be sure to press the lower part of the monitor with one hand, and shake the stand from side to side with the other hand to make some gap between them.

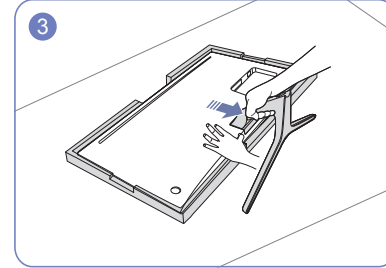

Press the lower part of the monitor with one hand, and pull the stand with the other hand in the direction of the arrow as shown in the figure.

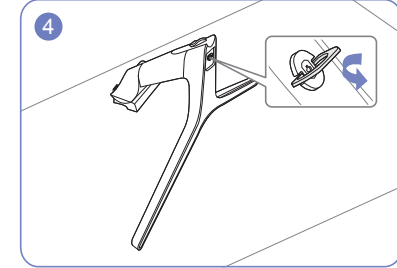

Remove the stand neck from the stand base by pulling it in the direction of the arrow as shown in the figure.



### - Caution

Do not press down on the monitor. There is a risk of damaging the monitor.

# Chapter 03

## Connecting and Using a Source Device

### Read below before installing the monitor.

- 1 Check the shapes of both ends of the cables that came with the monitor, and check the shapes and positions of the matching ports on the monitor and external devices.
- 2 Before connecting signal cables, disconnect the power cables for the monitor and external devices from the power outlet to prevent device damage from a short circuit or overcurrent.
- 3 After connecting all signal cables, connect the power cables for the monitor and external devices to the power outlet.
- 4 Read the user manual to familiarize yourself with the monitor functions, precautions, and proper use, before using the installed monitor.

### Connecting and Using a PC

Select a connection method suitable for your PC.

- Connecting parts may differ in different products.
- Provided ports may vary depending on the product.

### Connection Using the HDMI Cable



Check to make sure that the power cables for the monitor and external devices, such as computers and set-top boxes, are not connected to the power outlet.

HDMI IN 1, HDMI IN 2



- To display 3840 x 2160 @ 30 Hz, use an HDMI cable that supports 3840 x 2160 @ 30 Hz to connect HDMI1. Make sure that the graphics card of the HDMI source supports 3840 x 2160 @ 30 Hz.
- To display 3840 x 2160 @ 60 Hz, use an HDMI cable that supports 3840 x 2160 @ 60 Hz to connect HDMI2. Make sure that the graphics card of the HDMI source supports 3840 x 2160 @ 60 Hz.
- When connecting an HDMI cable, use the cable that came with the components of the monitor. If you use an HDMI cable other than provided by Samsung, the image quality may be degraded.

---

## Connection Using the HDMI-DVI Cable

- ⚠ Check to make sure that the power cables for the monitor and external devices, such as computers and set-top boxes, are not connected to the power outlet.

HDMI IN 1, HDMI IN 2

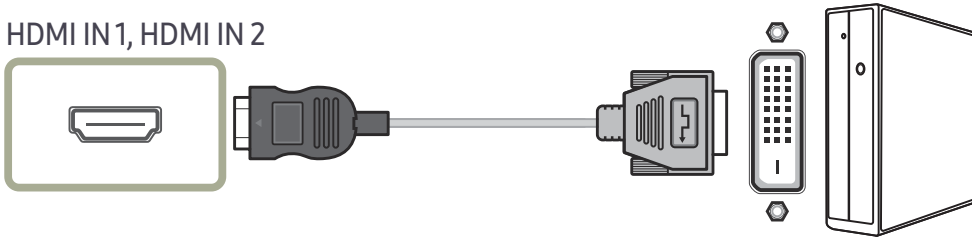

- The audio function is not supported if the source device is connected using the HDMI-DVI cable.
- The optimum resolution may not be available with an HDMI-DVI cable.

## Connection Using the DP Cable

- ⚠ Check to make sure that the power cables for the monitor and external devices, such as computers and set-top boxes, are not connected to the power outlet.

DP IN

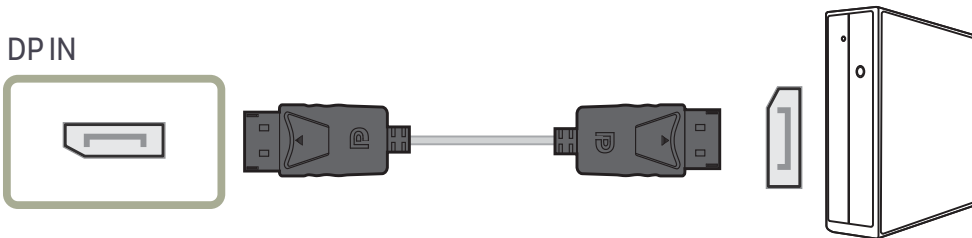

- To display 3840 x 2160 @ 60 Hz, use a DP cable that supports 3840 x 2160 @ 60 Hz. Make sure that the graphics card of the DP source supports 3840 x 2160 @ 60 Hz.

---

## Connecting to Headphones



- Use headphones when activating sound with an HDMI-HDMI or DP cable.
- The earphone jack supports only the 3 conductor tip-ring-sleeve (TRS) type.

---

## Connecting the Power

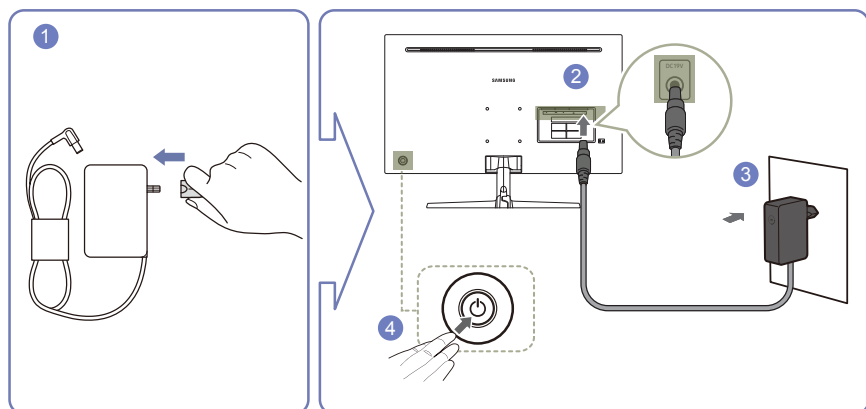

- 1 Connect the power plug to the AC/DC adapter.
  - 2 Connect the AC/DC adapter cable to the **DC 19V** port on the back of the monitor.
  - 3 Plug the AC/DC adapter into the power outlet.
  - 4 Press the JOG button on the back of the monitor to turn it on.
- The input voltage is switched automatically.
  - Specifications of the adapter may vary depending on the applicable quality requirements.

---

## Correct posture to use the product



Use the product in the correct posture as follows:

- Straighten your back.
- Allow a distance of 45 to 50cm between your eye and the screen, and look slightly downward at the screen.
- Keep your eyes directly in front of the screen.
- Adjust the angle so light does not reflect on the screen.
- Keep your forearms perpendicular to your upper arms and level with the back of your hands.
- Keep your elbows at about a right angle.
- Adjust the height of the product so you can keep your knees bent at 90 degrees or more, your heels attached to the floor, and your arms lower than your heart.
- Do the Eye exercises or blink frequently, then eye fatigue will be relieved.

---

## Driver Installation

- You can set the optimum resolution and frequency for this product by installing the corresponding drivers.
- To install the latest version of the product driver, download it from the Samsung Electronics website at <http://www.samsung.com>.

## Setting Optimum Resolution

An information message about setting optimum resolution will appear if you power on the product for the first time after purchase.

Select a language on the product and change the resolution on your PC to the optimum setting.

- If the optimum resolution is not selected, the message will appear up to three times for a specified time even when the product is turned off and on again.
- The optimum resolution can also be selected in Control Panel on your PC.



# Chapter 04

## Screen Setup

Configure the screen settings such as brightness.

A detailed description of each function is provided. Refer to your product for details.

— The functions available may vary depending on the product model. The color and shape of parts may differ from what is shown. Specifications are subject to change without notice to improve quality.

### SAMSUNG MAGIC Bright

This menu provides an optimum picture quality suitable for the environment where the product will be used.

- This menu is not available when **Eco Saving Plus** is enabled.
- This menu is not available when **Game Mode** is enabled.
- This menu is not available when **Eye Saver Mode** is enabled.
- Not available when **PIP/PBP Mode** is set to **On**.

You can customize the brightness to suit your preferences.

#### In PC mode

- **Custom**: Customize the contrast and brightness as required.
- **Standard**: Obtain a picture quality suitable for editing documents or using Internet.
- **Cinema**: Obtain the brightness and sharpness of TVs suitable for enjoying video and DVD content.
- **Dynamic Contrast**: Obtain balanced brightness through automatic contrast adjustment.

#### In AV mode

When the external input is connected through HDMI/DP and **PC/AV Mode** is set to **AV**, **SAMSUNG MAGIC Bright** has four automatic picture settings (**Dynamic**, **Standard**, **Movie** and **Custom**) that are preset at the factory. You can activate either **Dynamic**, **Standard**, **Movie** or **Custom**. You can select **Custom** which automatically recalls your personalized picture settings.

- **Dynamic**: Select this mode to view a sharper image than in **Standard** mode.
- **Standard**: Select this mode when the surroundings are bright. This also provides a sharp image.
- **Movie**: Select this mode when the surroundings are dark. This will save power and reduce eye fatigue.
- **Custom**: Select this mode when you want to adjust the image according to your preferences.

---

## Brightness

You can adjust the general brightness of the picture. (Range: 0~100)

A higher value will make the picture appear brighter.

- This menu is not available when **SAMSUNG MAGICBright** is set to **Dynamic Contrast** mode.
- This menu is not available when **Eco Saving Plus** is enabled.
- This menu is not available when **Eye Saver Mode** is enabled.

## Contrast

Adjust the contrast between the objects and background. (Range: 0~100)

A higher value will increase the contrast to make the object appear clearer.

- This option is not available when **SAMSUNG MAGICBright** is in **Cinema** or **Dynamic Contrast** mode.
- This menu is not available when **Game Mode** is enabled.
- This menu is not available when **PIP/PBP Mode** is set to **On** and the **Size** is set to  (PBP Mode).

---

## Sharpness

Make the outline of objects more clear or blurry. (Range: 0~100)

A higher value will make the outline of objects clearer.

- This option is not available when **SAMSUNG MAGICBright** is in **Cinema** or **Dynamic Contrast** mode.
- This menu is not available when **Game Mode** is enabled.
- Not available when **PIP/PBP Mode** is set to **On**.

## Color

Adjust the tint of the screen.

- This menu is not available when **SAMSUNG MAGICBright** is set to **Cinema** or **Dynamic Contrast** mode.
- This menu is not available when **Game Mode** is enabled.
- This menu is not available when **Eye Saver Mode** is enabled.
- Not available when **PIP/PBP Mode** is set to **On**.
- **Red**: Adjust the red saturation level. Values closer to 100 mean greater intensity for the color.
- **Green**: Adjust the green saturation level. Values closer to 100 mean greater intensity for the color.
- **Blue**: Adjust the blue saturation level. Values closer to 100 mean greater intensity for the color.
- **Color Tone**: Select a color tone that best suits your viewing needs.
  - **Cool 2**: Set the color temperature to be cooler than **Cool 1**.
  - **Cool 1**: Set the color temperature to be cooler than **Normal** mode.
  - **Normal**: Display the standard color tone.
  - **Warm 1**: Set the color temperature to be warmer than **Normal** mode.
  - **Warm 2**: Set the color temperature to be warmer than **Warm 1**.
  - **Custom**: Customize the color tone.
- When the external input is connected through HDMI/DP and **PC/AV Mode** is set to **AV**, **Color Tone** has four color temperature settings (**Cool**, **Normal**, **Warm** and **Custom**).
- **Gamma**: Adjust the middle level of luminance.
  - **Mode1** / **Mode2** / **Mode3**

---

## HDMI Black Level

If a DVD player or set-top box is connected to the product via HDMI, image quality degradation (contrast/color degradation, black level, etc.) may occur, depending on the connected source device. In such case, **HDMI Black Level** can be used to adjust the image quality.

If this is the case, correct the degraded picture quality using **HDMI Black Level**.

— This function is only available in **HDMI1** or **HDMI2** mode.

— Not available when **PIP/PBP Mode** is set to **On**.

- **Normal**: Select this mode when there is no contrast ratio degradation.
- **Low**: Select this mode to reduce the black level and increase the white level when there is a contrast ratio degradation.

— **HDMI Black Level** may not be compatible with some source devices.

— The **HDMI Black Level** feature is only activated at a certain **AV** resolution, such as 720P @ 60 Hz and 1080P @ 60 Hz.

## Eye Saver Mode

Set to an optimum picture quality suitable for eye relaxation.

TÜV Rheinland “Low Blue Light Content” is a certification for products which meet requirements for lower blue light levels. When **Eye Saver Mode** is 'On', the blue light that wavelength is around 400nm will decrease, and it will provide an optimum picture quality suitable for eye relaxation. At the same time, the blue light level is lower than in the default settings, and it was tested by TÜV Rheinland and certified as it met the requirements of TÜV Rheinland “Low Blue Light Content” standards.

— Not available when **PIP/PBP Mode** is set to **On**.

---

## Game Mode

Configure the product screen settings for game mode.

Use this feature when playing games on a PC or when a game console such as PlayStation™ or Xbox™ is connected.

— This menu is not available when **Eye Saver Mode** is enabled.

— When the monitor turns off, enters power-saving mode or changes input sources, **Game Mode** turns **Off** even if it is set to **On**.

— If you want to keep **Game Mode** enabled all the time, select **Always On**.

— This menu is not available when **Eco Saving Plus** is enabled.

— Not available when **PIP/PBP Mode** is set to **On**.

## Response Time

Accelerate the panel response rate to make video appear more vivid and natural.

— Use **Standard** mode when not playing a video or game.

— This menu is not available when **PIP/PBP Mode** is set to **On** and the **Size** is set to  /  /  (PIP Mode).

---

## Picture Size

Change the picture size.

- This menu is not available when **PIP/PBP Mode** is set to **On** and the **Size** is set to  (PBP Mode).
- This option is not available when **FreeSync** is enabled.

### In PC mode

- **Auto**: Display the picture according to the aspect ratio of the input source.
- **Wide**: Display the picture in full screen regardless of the aspect ratio of the input source.

### In AV mode

- **4:3**: Display the picture with an aspect ratio of 4:3. Suitable for videos and standard broadcasts.
  - **16:9**: Display the picture with an aspect ratio of 16:9.
  - **Screen Fit**: Display the picture with the original aspect ratio without cutting off.
- The function may not be supported depending on the ports provided with the product.
  - Changing the screen size is available when the following conditions are satisfied.
    - A digital output device is connected using the HDMI/DP cable.
    - The input signal is 480p, 576p, 720p, or 1080p and monitor can display normally (Not every model can support all of these signals.).
    - This can only be set when the external input is connected through HDMI/DP and **PC/AV Mode** is set to **AV**.

---

## Screen Adjustment

- This menu is only available when **Picture Size** is set to **Screen Fit** in **AV Mode**.  
When a 480P or 576P or 720P or 1080P signal is input in **AV** mode and the monitor can display normally, select **Screen Fit** to adjust horizontal position in 0-6 levels.

### Configuring H-Position & V-Position

- H-Position**: Move the screen to the left or right.
- V-Position**: Move the screen up or down.

# Chapter 05

## Configuring the PIP/PBP Settings

A detailed description of each function is provided. Refer to your product for details.

- The functions available may vary depending on the product model. The color and shape of parts may differ from what is shown. Specifications are subject to change without notice to improve quality.

### PIP/PBP Mode

Enable or disable the **PIP/PBP Mode** function.

The PIP (Picture in Picture) function separates the screen into two parts. One source device is displayed on the main screen at the same time the another source device is displayed in inset windows.

The PBP (Picture by Picture) function separates the screen in half displaying output from two different source devices simultaneously on the left and right sides of the screen.

- **PIP/PBP** mode is compatible with Windows 7, Windows 8, and Windows 10.
- The **PIP/PBP** function may not be available depending on the specifications of the graphics card used. If the screen is blank in **PIP/PBP** mode when the optimum resolution is selected, go to **Control Panel → Display → Screen Resolution** and click **Detect** on the PC. (Instructions are based on Windows 7.) If the screen is blank when the resolution is set to the optimum resolution, change the resolution to 1280 x 1024.
- The screen may flicker briefly or appear after a delay when you enable or disable the **PIP/PBP** function or when you change the screen size with the **PIP/PBP** function activated. This can typically arise when a PC and a monitor are connected to two or more input sources. It has nothing to do with the performance of a monitor. The issue is mainly caused when the video signals are delayed in transmission to the monitor depending on the graphics card performance.

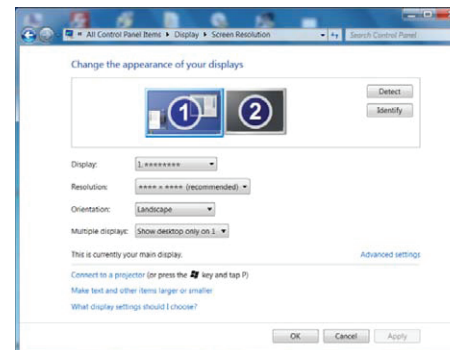





- To maximize the picture quality and Sound can be normal output it is recommended to use a graphics card or DVD that supports 4K (3840 x 2160 @ 30 Hz) resolution when connect **HDMI1** port.
- To maximize the picture quality and Sound can be normal output it is recommended to use a graphics card or DVD that supports 4K (3840 x 2160 @ 60 Hz) resolution when connect **HDMI2** port.
- When the **PIP/PBP** function is enabled, the resolution will not be able to automatically switch to the optimum resolution due to a compatibility issue between the graphics card and the Windows system. Set **PIP/PBP Mode** to **Off**. Alternatively, restart the monitor, then set the resolution to the optimum setting using the Windows interface.

---

## Size

Select the size and aspect ratio of the sub-screen.

- : Select the icon image if you want to use PBP mode where the optimum resolution for the left and right sides of the screen is 1920 x 2160 (width x height).
- : Select the icon image if you want to use PIP mode where the optimum resolution for the sub-screen is 720 x 480 (width x height).
- : Select the icon image if you want to use PIP mode where the optimum resolution of the sub-screen is 1280 x 720 (width x height).
- : Select the icon image if you want to use PIP mode where the optimum resolution of the sub-screen is 1920 x 1080 (width x height).

## Position

Select the position of the sub-screen from the available options.

- 

— Not available when PBP is selected.

— The screen may flicker if the input signal is unstable.

---

## Sound Source

Set which screen you want to hear the sound for.

### PIP mode



### PBP mode



---

## Source

Select the source for each screen.

### PIP Mode (available in PIP mode (Size / / ))

- The input source for the main screen changes.
- With the exception of the current input source, the other two input sources can be selected.
- The screen may flicker if the input signal is unstable.
- When the Function Key Guide appears, move the JOG button LEFT to select the  icon and then press the JOG button. The main screen will switch in the order **DisplayPort** → **HDMI1** → **HDMI2**.

### PBP Mode (available in PBP mode (Size ))

- The input source for the main screen changes.
- The screen may flicker if the input signal is unstable.
- When the input signal of the left and right screens are the same, the operation cannot be performed.
- When the Function Key Guide appears, move the JOG button LEFT to select the  icon and then press the JOG button. The same PBP source setting menu appears.

---

## Picture Size

### PIP Mode (available in PIP mode (Size / / ))

Select the image size for sub-screen.

#### In PC mode

- **Auto:** Display the picture according to the aspect ratio of the each screen input source.
- **Wide:** Display the picture in full screen regardless of the aspect ratio of the each screen input source.

#### In AV mode

- **4:3:** Display the picture of the sub-screen with an aspect ratio of 4:3. Suitable for videos and standard broadcasts.
  - **16:9:** Display the picture of the sub-screen with an aspect ratio of 16:9.
  - **Screen Fit:** Display the picture of the sub-screen with the original aspect ratio without cutting anything off.
- The function may not be supported depending on the ports provided with the product.
  - Changing the screen size is available when the following conditions are satisfied.
    - A digital output device is connected using the HDMI/DP cable.
    - The input signal is 480p, 576p, 720p, or 1080p and monitor can display normally (Not every model can support all of these signals.).
    - This can only be set when the external input is connected through HDMI/DP and **PC/AV Mode** is set to **AV**.

---

## PBP Mode (available in PBP mode(Size ))

Set the **Picture Size** for each of the divided screens.

### In PC mode

- **Auto**: Display the picture according to the aspect ratio of the each screen input source.
- **Wide**: Display the picture in full screen regardless of the aspect ratio of the each screen input source.

### In AV mode

- **4:3**: Display the picture of the sub-screen with an aspect ratio of 4:3. Suitable for videos and standard broadcasts.
- **16:9**: Display the picture of the sub-screen with an aspect ratio of 16:9.
- **Screen Fit**: Display the picture of the sub-screen with the original aspect ratio without cutting anything off.

— The function may not be supported depending on the ports provided with the product.

— Changing the screen size is available when the following conditions are satisfied.

— A digital output device is connected using the HDMI/DP cable.

— The input signal is 480p, 576p, 720p, or 1080p and monitor can display normally (Not every model can support all of these signals.).

— This can only be set when the external input is connected through HDMI/DP and **PC/AV Mode** is set to **AV**.

---

## Contrast

### PIP Mode (available in PIP mode(Size / / ))

Adjust the contrast level for sub-screen.

### PBP Mode (available in PBP mode(Size ))

Adjust the contrast level for each screen.



# Chapter 06

## Adjusting OSD (On Screen Display) settings

A detailed description of each function is provided. Refer to your product for details.

— The functions available may vary depending on the product model. The color and shape of parts may differ from what is shown. Specifications are subject to change without notice to improve quality.

### Transparency

Set the transparency for the menu windows.

### Language

Set the menu language.

- A change to the language setting will only be applied to the onscreen menu display.
- It will not be applied to other functions on your PC.

### Display Time

Set the on-screen display (OSD) menu to automatically disappear if the menu is not used for a specified period of time.

**Display Time** can be used to specify the time after which you want the OSD menu to disappear.

# Chapter 07

## Setup and Reset

A detailed description of each function is provided. Refer to your product for details.

— The functions available may vary depending on the product model. The color and shape of parts may differ from what is shown. Specifications are subject to change without notice to improve quality.

### FreeSync

**FreeSync** technology is solution that eliminates screen tearing without all the usual lag and latency. This feature will eliminate screen tearing and lag during game play. Improve your gaming experience. The displayed **FreeSync** menu items on the monitor may vary, depending on the monitor model and compatibility with the AMD graphics card.

— Not available when **PIP/PBP Mode** is set to **On**.

— The sound quality of the monitor may decrease if **FreeSync** is enabled.

- **Off**: Disable **FreeSync**.
- **Standard Engine**: Enable the basic **FreeSync** functions of the AMD graphics card.
- **Ultimate Engine**: Enable the **FreeSync** feature with a higher screen frame rate. Screen tearing (abnormal sync between the screen and content) is reduced in this mode. Note that screen flickering may occur during game play.

Apply the optimum resolution when using **FreeSync**.

The refresh rate setting method please refer to Q & A → How can I change the frequency?

— The **FreeSync** function is only enabled in **HDMI2** or **DisplayPort** mode.

Use the HDMI/DP cable provided by the manufacturer when using **FreeSync**.

If you use the **FreeSync** function while playing a game, the following symptoms may occur:

- The screen may flicker depending on the type of graphics card, the game option settings, or the video being played. Try the following actions: decrease the game setting values, change the current **FreeSync** mode to **Standard Engine**, or visit the AMD website to check your graphics driver's version and update it with the latest one.
- While you are using the **FreeSync** function, the screen may flicker due to variation of the output frequency from the graphics card.
- The response rate during the game may fluctuate depending on the resolution. A higher resolution generally decreases the response rate.
- The sound quality of the monitor may be degraded.

— If you encounter any issues when using the function, contact the Samsung Service Center.

— When the resolution is changed while setting **FreeSync** to **Standard Engine** or **Ultimate Engine**, the screen tearing can happen intermittently. Set **FreeSync** to **Off** and change the resolution.

— The function is unavailable in the devices (e.g. AV devices) that have no AMD graphic card. If the function is applied, the screen may have malfunction.

## The models in the Graphic Cards list supports FreeSync

**FreeSync** can only be used with specific AMD graphics card models. Refer to the following list for supported graphics cards:

Make sure to install the latest official graphics drivers from AMD that support **FreeSync**.

For additional AMD graphics card models that support the **FreeSync** feature, visit the official AMD website.

Select **FreeSync Off** if you are using a graphics card from a different manufacturer.

When applying the **FreeSync** function via the HDMI interface, it may fail to work due to the bandwidth limitation of certain AMD display cards.

- AMD Radeon R9 300 Series (Not include 370/370X)
- AMD Radeon R9 Fury X
- AMD Radeon R7 360
- AMD Radeon R9 295X2
- AMD Radeon R9 290X
- AMD Radeon R9 290
- AMD Radeon R9 285
- AMD Radeon R7 260X
- AMD Radeon R7 260
- AMD Radeon RX 400 Series

## How do you enable FreeSync?

1 Set **FreeSync** to **Standard Engine** or **Ultimate Engine** in the OSD menu.

2 Enable **FreeSync** in AMD Radeon Settings:

Right-click the mouse → AMD Radeon Settings → Display

The "AMD FreeSync" feature should be set to "On". Select to "On" if not already enabled.

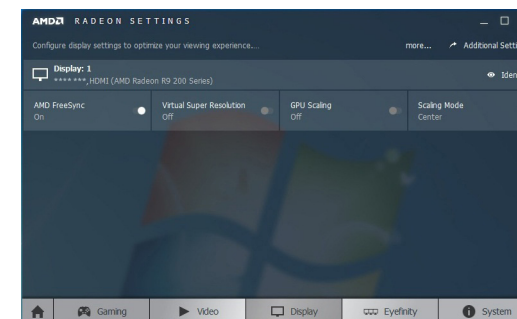
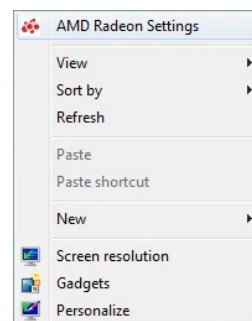

---

## Eco Saving Plus

Reduce energy consumption compared to consumption at the maximum brightness level.

- This option is not available when <sup>SAMSUNG</sup>MAGICBright is in **Dynamic Contrast** mode.
- This menu is not available when **Game Mode** is enabled.
- This menu is not available when **Eye Saver Mode** is enabled.
- Not available when **PIP/PBP Mode** is set to **On**.
- **Off**: Deactivate the **Eco Saving Plus** function.
- **Auto**: The power consumption will automatically be reduced by about 10% over the current setting. (The reduction of power consumption depends on the customer screen brightness condition.)
- **Low**: Saves up to 25 % energy compared to the maximum brightness.
- **High**: Saves up to 50 % energy compared to the maximum brightness.

---

## Off Timer Plus

### Configuring Off Timer

**Off Timer**: Turn on **Off Timer** mode.

**Turn Off After**: The off timer can be set within a range of 1 to 23 hours. The product will automatically power off after the specified number of hours.

- This option is only available when **Off Timer** is set to **On**.
- For products for the market in some regions, the **Off Timer** is set to automatically activate 4 hours after the product powers on. This is done in accordance with power supply regulations. If you do not want the timer to activate, go to **[[[** → **System** → **Off Timer Plus** and set **Off Timer** to **Off**.

### Configuring Eco Timer

**Eco Timer**: Turn on **Eco Timer** mode.

**Eco Off After**: The **Eco Timer** can be set between 10 and 180 minutes. The product will automatically power off after the specified time has elapsed.

- This option is only available when **Eco Timer** is set to **On**.

---

## PC/AV Mode

Set **PC/AV Mode** to **AV**. The picture size will be enlarged.

This option is useful when you view a movie.

- Set to **PC** when connected to a PC.
- Set to **AV** when connected to an AV device.

— Supplied for the wide models only such as 16:9 or 16:10.

— If the monitor (when set to **HDMI1**, **HDMI2**, **DisplayPort**) is in power saving mode or is displaying the message **Check Signal Cable**, press the  icon to display the On Screen Display (OSD). You can select **PC** or **AV**.

## DisplayPort Ver.

Select your Displayport.

— Incorrect settings may cause the screen to go blank. If this occurs, check the device specifications.

— If the monitor (when set to **HDMI1**, **HDMI2**, **DisplayPort**) is in power saving mode or is displaying the message **Check Signal Cable**, press the  icon to display the On Screen Display (OSD). You can select **1.1** or **1.2†**.

— If you select **1.1**, the maximum resolution of your screen drops to 2560 x 1440 due to the limitations in HBR1 transmission speeds.

## Source Detection

Select either **Auto** or **Manual** as the method to recognize input signal.

— Not available when **PIP/PBP Mode** is set to **On**.

---

## Key Repeat Time

Control the response rate of a button when the button is pressed.

**Acceleration**, **1 sec**, or **2 sec** can be selected. If **No Repeat** is selected, a command responds only once when a button is pressed.

## Power LED On

Configure the settings to enable or disable the power LED located at the lower part of the product.

- **Working**: The power LED is on when the product is turned on.
- **Stand-by**: The power LED is on when the product is turned off.

## Reset All

Return all the settings for the product to the default factory settings.

# Information

View the current input source, frequency and resolution.

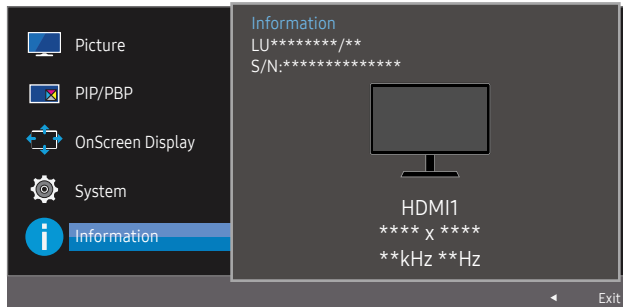

PIP

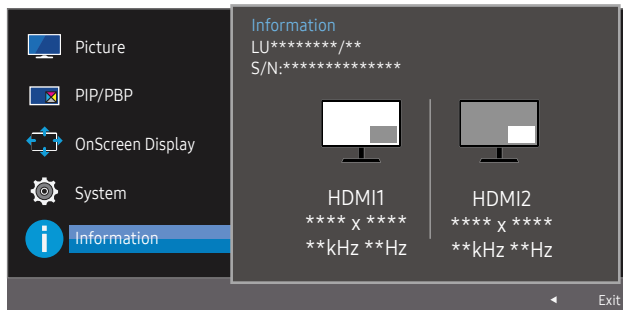

PBP

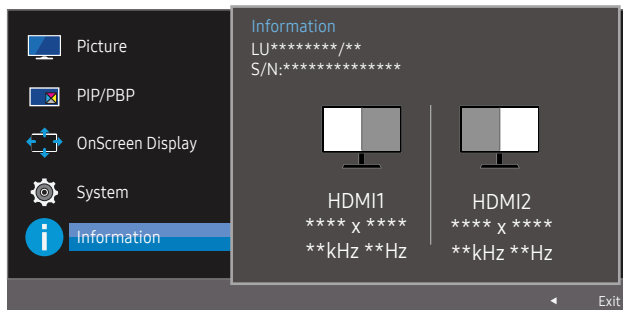

— The displayed image may differ depending on the model.

# Chapter 08

## Installing the Software

### Easy Setting Box



Easy Setting Box enables users to use the monitor by partitioning multiple sections.

To install the latest version of **Easy Setting Box**, download it from the Samsung Electronics website at <http://www.samsung.com>.

- The software may not work properly if you do not restart the computer after the installation.
- The Easy Setting Box icon may not appear depending on the computer system and the product specifications.
- If the shortcut icon does not appear, press the F5 key.

### Restrictions and Problems with the Installation

The **Easy Setting Box** installation may be affected by the Graphics Card, Motherboard and the Networking Environment.

### System Requirements

OS	Hardware
<ul style="list-style-type: none"><li>• Windows 7 32Bit/64Bit</li><li>• Windows 8 32Bit/64Bit</li><li>• Windows 8.1 32Bit/64Bit</li><li>• Windows 10 32Bit/64Bit</li></ul>	<ul style="list-style-type: none"><li>• At least 32MB of memory</li><li>• At least 60MB of free space on the hard disk drive</li></ul>

# Chapter 09

## Troubleshooting Guide

### Requirements Before Contacting Samsung Customer Service Center

— Before calling Samsung Customer Service Center, test your product as follows. If the problem persists, contact Samsung Customer Service Center.

#### Testing the Product

Check if your product is operating normally by using the product test function.

If the screen is turned off and the power indicator blinks even though the product is properly connected to a PC, perform a self-diagnosis test.

- 1 Power off both the PC and product.
- 2 Disconnect the cables from the product.
- 3 Power on the product.
- 4 If the message **Check Signal Cable** appears, the product is working normally.

— If the screen remains blank, check the PC system, video controller and cable.

#### Checking the Resolution and Frequency

For a mode that exceeds the supported resolution (refer to [Standard Signal Mode Table](#)), the message **Not Optimum Mode** will appear for a short time.

— The displayed resolution may vary, depending on the computer system settings and cables.

Check the following.

#### Installation issue (PC mode)

---

**The screen keeps switching on and off.**

Check the cable connection between the product and PC, and ensure the connectors are locked.

---

**Blank spaces are found on all four sides of the screen when an HDMI or HDMI-DVI cable is connected to the product and PC.**

The blank spaces found on the screen have nothing to do with the product.

Blank spaces on the screen are caused by the PC or graphics card. To resolve the problem, adjust the screen size in the HDMI or DVI settings for the graphics card.

If the graphics card settings menu does not have an option to adjust the screen size, update the graphics card driver to the latest version.

(Please contact the graphics card or computer manufacturer for further details about how to adjust the screen settings.)

---

#### Screen issue

---

**The power LED is off. The screen will not switch on.**

Check that the power cable is connected properly.

---

**The message **Check Signal Cable** appears.**

Check that the cable is properly connected to the product.

Check that the device connected to the product is powered on.

---



---

**Not Optimum Mode** is displayed.

This message appears when the signal from the graphics card exceeds the maximum resolution or frequency for the product.

Change the maximum resolution and frequency to suit the product performance, referring to Standard Signal Mode Table (P.44).

---

**The images on the screen look distorted.**

Check the cable connection to the product.

---

**The screen is not clear. The screen is blurry.**

Remove any accessories (video extension cable, etc.) and try again.

Set the resolution and frequency to the recommended level.

---

**The screen appears unstable and shaky. There are shadows or ghost images left on the screen.**

Check that the resolution and frequency for the PC are within the range of resolution and frequency compatible with the product. Next, if required, change the settings, referring to Standard Signal Mode Table (P.44) in this manual and the **Information** menu on the product.

---

**The screen is too bright. The screen is too dark.**

Adjust **Brightness** and **Contrast**.

---

**Screen color is inconsistent.**

Change the **Color** settings.

---

**The colors on the screen have a shadow and are distorted.**

Change the **Color** settings.

---

**White does not really look white.**

Change the **Color** settings.

---

**There is no image on the screen and the power LED blinks every 0.5 to 1 second.**

The product is operating in power-saving mode.

Press any key on the keyboard or move the mouse to return to normal operating mode.

---

**Text is blurry.**

If using a Windows OS (e.g. Windows 7, Windows 8, Windows 8.1 or Windows 10): Go to **Control Panel** → **Fonts** → **Adjust ClearType text** and change **Turn on ClearType**.

---

---

**Video playback is choppy.**

Playback of high-definition large video files can be choppy. This may be because the video player is not optimized for the computer resource.

Try playing the file on another video player.

---

## Sound issue

---

**There is no sound.**

Check the connection of the audio cable or adjust the volume.

Check the volume.

---

**The volume is too low.**

Adjust the volume.

If the volume is still low after turning it up to the maximum level, adjust the volume on your PC sound card or software program.

---

**Video is available but there is no sound.**

Sound cannot be heard if a HDMI-DVI cable is used to connect the input device.

Connect the device using an HDMI cable or DP cable.

---

## Source device issue

---

**A beeping sound is heard when my PC is booting.**

If a beeping sound is heard when your PC is booting, have your PC serviced.

---

---

## Q & A

— Refer to the user manual for your PC or graphics card for further instructions on adjustment.

---

### How can I change the frequency?

Set the frequency on your graphics card.

- Windows 7: Go to **Control Panel** → **Appearance and Personalization** → **Display** → **Screen Resolution** → **Advanced settings** → **Monitor**, and adjust **Refresh rate** under **Monitor settings**.
- Windows 8(Windows 8.1): Go to **Settings** → **Control Panel** → **Appearance and Personalization** → **Display** → **Screen Resolution** → **Advanced settings** → **Monitor**, and adjust **Refresh rate** under **Monitor settings**.
- Windows 10: Go to **Settings** → **System** → **Display** → **Advanced display settings** → **Display adapter properties** → **Monitor**, and adjust **Screen refresh rate** under **Monitor settings**.

---

### How can I change the resolution?

- Windows 7: Go to **Control Panel** → **Appearance and Personalization** → **Display** → **Adjust Resolution**, and adjust the resolution.
- Windows 8(Windows 8.1): Go to **Settings** → **Control Panel** → **Appearance and Personalization** → **Display** → **Adjust Resolution**, and adjust the resolution.
- Windows 10: Go to **Settings** → **System** → **Display** → **Advanced display settings**, and adjust the resolution.

---

### How do I set power-saving mode?

- Windows 7: Set power-saving mode in **Control Panel** → **Appearance and Personalization** → **Personalize** → **Screen Saver Settings** → **Power options** or **BIOS SETUP** on the PC.
  - Windows 8(Windows 8.1): Set power-saving mode in **Settings** → **Control Panel** → **Appearance and Personalization** → **Personalize** → **Screen Saver Settings** → **Power options** or **BIOS SETUP** on the PC.
  - Windows 10: Set power-saving mode in **Settings** → **Personalization** → **Lock screen** → **Screen timeout settings** → **Power & sleep** or **BIOS SETUP** on the PC.
-

# Chapter 10

## Specifications

### General

Model Name	U32J590UQ* / U32J592UQ*
Size	80.1 cm
Display area	698.4 mm (H) x 392.85 mm (V)
Pixel Pitch	0.181 mm (H) x 0.181 mm (V)
Maximum Pixel Clock	533.25 MHz (DisplayPort) 297.00 MHz (HDMI1) 594.00 MHz (HDMI2)
Power Supply	AC100-240V~ 50/60Hz Based on the AC voltage of the adapter. For the DC voltage of the product, refer to the product label.
Signal connectors	HDMI, DisplayPort
Environmental conditions	<b>Operating</b> Temperature: 10 °C – 40 °C (50 °F – 104 °F) Humidity: 10 % – 80 %, non-condensing <b>Storage</b> Temperature: -20 °C – 45 °C (-4 °F – 113 °F) Humidity: 5 % – 95 %, non-condensing

- Plug-and-Play  
This monitor can be installed and used with any Plug-and-Play compatible systems. Two-way data exchange between the monitor and PC system optimizes the monitor settings. Monitor installation takes place automatically. However, you can customize the installation settings if desired.
- Panel Dots (Pixels)  
Due to the nature of the manufacturing of this product, approximately 1 pixel per million (1ppm) may be brighter or darker on the LCD panel. This does not affect product performance.
- The above specifications are subject to change without notice to improve quality.
- This device is a Class B digital apparatus.
- For detailed device specifications, visit the Samsung Electronics website.

## Standard Signal Mode Table

Model Name	U32J590UQ* / U32J592UQ*	
Synchronization	Horizontal Frequency	30 – 135 kHz
	Vertical Frequency	56 – 75 Hz (DisplayPort) 24 – 75 Hz (HDMI1/HDMI2)
Resolution	Optimum Resolution	3840 x 2160 @ 60 Hz (DisplayPort) 3840 x 2160 @ 30 Hz (HDMI1) 3840 x 2160 @ 60 Hz (HDMI2)
	Maximum Resolution	3840 x 2160 @ 60 Hz (DisplayPort) 3840 x 2160 @ 30 Hz (HDMI1) 3840 x 2160 @ 60 Hz (HDMI2)

If a signal that belongs to the following standard signal modes is transmitted from your PC, the screen will automatically be adjusted. If the signal transmitted from the PC does not belong to the standard signal modes, the screen may be blank even though the power LED turns on. In such a case, change the settings according to the following table by referring to the graphics card user manual.

### Displayport

Resolution	Horizontal Frequency (kHz)	Vertical Frequency (Hz)	Pixel Clock (MHz)	Sync Polarity (H/V)
IBM, 720 x 400	31.469	70.087	28.322	-/+
VESA, 640 x 480	31.469	59.940	25.175	-/-
MAC, 640 x 480	35.000	66.667	30.240	-/-
VESA, 640 x 480	37.861	72.809	31.500	-/-
VESA, 640 x 480	37.500	75.000	31.500	-/-
VESA, 800 x 600	35.156	56.250	36.000	+/+
VESA, 800 x 600	37.879	60.317	40.000	+/+
VESA, 800 x 600	48.077	72.188	50.000	+/+
VESA, 800 x 600	46.875	75.000	49.500	+/+
MAC, 832 x 624	49.726	74.551	57.284	-/-
VESA, 1024 x 768	48.363	60.004	65.000	-/-
VESA, 1024 x 768	56.476	70.069	75.000	-/-
VESA, 1024 x 768	60.023	75.029	78.750	+/+
VESA, 1152 x 864	67.500	75.000	108.000	+/+

## Displayport

Resolution	Horizontal Frequency (kHz)	Vertical Frequency (Hz)	Pixel Clock (MHz)	Sync Polarity (H/V)
MAC, 1152 x 870	68.681	75.062	100.000	-/-
VESA, 1280 x 720	45.000	60.000	74.250	+/+
VESA, 1280 x 800	49.702	59.810	83.500	-/+
VESA, 1280 x 1024	63.981	60.020	108.000	+/+
VESA, 1280 x 1024	79.976	75.025	135.000	+/+
VESA, 1440 x 900	55.935	59.887	106.500	-/+
VESA, 1600 x 900	60.000	60.000	108.000	+/+
VESA, 1680 x 1050	65.290	59.954	146.250	-/+
VESA, 1920 x 1080	67.500	60.000	148.500	+/+
VESA, 2560 x 1440	88.787	59.951	241.500	+/-
VESA, 3840 x 2160	133.313	59.997	533.250	+/-

## HDMI1

Resolution	Horizontal Frequency (kHz)	Vertical Frequency (Hz)	Pixel Clock (MHz)	Sync Polarity (H/V)
IBM, 720 x 400	31.469	70.087	28.322	-/+
VESA, 640 x 480	31.469	59.940	25.175	-/-
MAC, 640 x 480	35.000	66.667	30.240	-/-
VESA, 640 x 480	37.861	72.809	31.500	-/-
VESA, 640 x 480	37.500	75.000	31.500	-/-
VESA, 800 x 600	35.156	56.250	36.000	+/+
VESA, 800 x 600	37.879	60.317	40.000	+/+
VESA, 800 x 600	48.077	72.188	50.000	+/+
VESA, 800 x 600	46.875	75.000	49.500	+/+
MAC, 832 x 624	49.726	74.551	57.284	-/-
VESA, 1024 x 768	48.363	60.004	65.000	-/-
VESA, 1024 x 768	56.476	70.069	75.000	-/-
VESA, 1024 x 768	60.023	75.029	78.750	+/+
VESA, 1152 x 864	67.500	75.000	108.000	+/+
MAC, 1152 x 870	68.681	75.062	100.000	-/-
VESA, 1280 x 720	45.000	60.000	74.250	+/+

## HDMI1

Resolution	Horizontal Frequency (kHz)	Vertical Frequency (Hz)	Pixel Clock (MHz)	Sync Polarity (H/V)
VESA, 1280 x 800	49.702	59.810	83.500	-/+
VESA, 1280 x 1024	63.981	60.020	108.000	+/+
VESA, 1280 x 1024	79.976	75.025	135.000	+/+
VESA, 1440 x 900	55.935	59.887	106.500	-/+
VESA, 1600 x 900	60.000	60.000	108.000	+/+
VESA, 1680 x 1050	65.290	59.954	146.250	-/+
VESA, 1920 x 1080	67.500	60.000	148.500	+/+
VESA, 2560 x 1440	88.787	59.951	241.500	+/-
CEA, 3840 x 2160	67.500	30.000	297.000	+/+

## HDMI2

Resolution	Horizontal Frequency (kHz)	Vertical Frequency (Hz)	Pixel Clock (MHz)	Sync Polarity (H/V)
IBM, 720 x 400	31.469	70.087	28.322	-/+
VESA, 640 x 480	31.469	59.940	25.175	-/-
MAC, 640 x 480	35.000	66.667	30.240	-/-
VESA, 640 x 480	37.861	72.809	31.500	-/-
VESA, 640 x 480	37.500	75.000	31.500	-/-
VESA, 800 x 600	35.156	56.250	36.000	+/+
VESA, 800 x 600	37.879	60.317	40.000	+/+
VESA, 800 x 600	48.077	72.188	50.000	+/+
VESA, 800 x 600	46.875	75.000	49.500	+/+
MAC, 832 x 624	49.726	74.551	57.284	-/-
VESA, 1024 x 768	48.363	60.004	65.000	-/-
VESA, 1024 x 768	56.476	70.069	75.000	-/-
VESA, 1024 x 768	60.023	75.029	78.750	+/+
VESA, 1152 x 864	67.500	75.000	108.000	+/+
MAC, 1152 x 870	68.681	75.062	100.000	-/-
VESA, 1280 x 720	45.000	60.000	74.250	+/+
VESA, 1280 x 800	49.702	59.810	83.500	-/+
VESA, 1280 x 1024	63.981	60.020	108.000	+/+

## HDMI2

Resolution	Horizontal Frequency (kHz)	Vertical Frequency (Hz)	Pixel Clock (MHz)	Sync Polarity (H/V)
VESA, 1280 x 1024	79.976	75.025	135.000	+/+
VESA, 1440 x 900	55.935	59.887	106.500	-/+
VESA, 1600 x 900	60.000	60.000	108.000	+/+
VESA, 1680 x 1050	65.290	59.954	146.250	-/+
VESA, 1920 x 1080	67.500	60.000	148.500	+/+
VESA, 2560 x 1440	88.787	59.951	241.500	+/-
CEA, 3840 x 2160	135.000	60.000	594.000	+/+

### Horizontal Frequency

The time required to scan a single line from the left to the right side of the screen is called a horizontal cycle. The reciprocal number of a horizontal cycle is called horizontal frequency. Horizontal frequency is measured in kHz.

### Vertical Frequency

Repeating the same picture dozens of times per second allows you to view natural pictures. The repeat frequency is called "vertical frequency" or "refresh rate" and is indicated in Hz.

This product can be set to only one resolution for each screen size to obtain the optimum picture quality due to the nature of the panel. Using a resolution other than the specified resolution may degrade the picture quality. To avoid this, it is recommended that you select the optimum resolution specified for your product.

Some resolutions listed in the table above may not be available depending on graphics card specifications.

# Chapter 11

## Appendix

### Responsibility for the Pay Service (Cost to Customers)

— When the service is requested, in spite of in warranty, we may charge you for a visit from a service technician in the following cases.

#### Not a product defect

Cleaning of the product, Adjustment, Explanation, Re-installation and etc.

- If a service technician gives instructions on how to use product or simply adjusts options without disassembling product.
- If a defect is caused by external environmental factors (Internet, Antenna, Wired Signal, etc.)
- If a product is reinstalled or devices are connected additionally after installing the purchased product for the first time.
- If a product is reinstalled to move to a different spot or to move to a different house.
- If customer requests instructions on how to use because of another company's product.
- If customer requests instructions on how to use the network or another company's Program.
- If customer requests software installation and setup for the product.
- If a service technician removes/cleans dusts or foreign materials inside of the product.
- If customer requests an installation additionally after purchasing a product through home-shopping or online.

### A Product damage caused by customer's fault

Product damage caused by customer's mishandling or wrong repair

If a product damage is caused by;

- External impact or drop.
- Use of supplies or separately sold product unspecified by Samsung.
- Repair from a person besides an engineer of outsourcing service company or partner of Samsung Electronics Co., Ltd.
- Remodeling or repairing the product by customer.
- Using it with incorrect voltage or non-authorized electrical connections.
- Not following the "cautions" in User Manual.

#### Others

- If product fails by natural disaster. (lightning, fire, earthquake, flood damage, etc)
- If consumable components are all used up. (Battery, Toner, Fluorescent lights, Head, Vibrator, Lamp, Filter, Ribbon, etc.)

— If customer requests a service in case the product has no defect, service fee may be charged. So please read User Manual first.