



AD27QD
GAMING MONITOR
USER GUIDE

Copyright

© 2018 GIGA-BYTE TECHNOLOGY CO., LTD. All rights reserved.

The trademarks mentioned in this manual are legally registered to their respective owners.

Disclaimer

Information in this manual is protected by copyright laws and is the property of GIGABYTE.

Changes to the specifications and features in this manual may be made by GIGABYTE without prior notice.

No part of this manual may be reproduced, copied, translated, transmitted, or published in any form or by any means without GIGABYTE's prior written permission.

- In order to assist in the use of this monitor, carefully read the User Guide.
- For more information, check on our website at:
<https://www.gigabyte.com>

SAFETY INFORMATION

Regulatory Notices

Federal Communications Commission Statement

This device complies with Part 15 of the FCC Rules. Operation is subject to the following two conditions:

- This device may not cause harmful interference, and
- This device must accept any interference received including interference that may cause undesired operation.

This equipment has been tested and found to comply with the limits for a Class B digital device, pursuant to Part 15 of the FCC Rules. These limits are designed to provide reasonable protection against harmful interference in a residential installation. This equipment generates, uses and can radiate radio frequency energy and, if not installed and used in accordance with manufacturer's instructions, may cause harmful interference to radio communications. However, there is no guarantee that interference will not occur in a particular installation. If this equipment does cause harmful interference to radio or television reception, which can be determined by turning the equipment off and on, the user is encouraged to try to correct the interference by one or more of the following measures:

- Reorient or relocate the receiving antenna.
- Increase the separation between the equipment and receiver.
- Connect the equipment to an outlet on a circuit different from that to which the receiver is connected.
- Consult the dealer or an experienced radio/TV technician for help.

Canadian Department of Communications Statement

This digital apparatus does not exceed the Class B limits for radio noise emissions from digital apparatus set out in the Radio Interference Regulations of the Canadian Department of Communications.

This class B digital apparatus complies with Canadian ICES-003.

European Community Restriction of Hazardous Substances (RoHS) Directive Statement

GIGABYTE products have not intended to add and safe from hazardous substances (Cd, Pb, Hg, Cr+6, PBDE and PBB). The parts and components have been carefully selected to meet RoHS requirement. Moreover, we at GIGABYTE are continuing our efforts to develop products that do not use internationally banned toxic chemicals.

European Community Waste Electrical & Electronic Equipment (WEEE) Directive Statement

GIGABYTE will fulfill the national laws as interpreted from the 2012/19/ EU WEEE (Waste Electrical and Electronic Equipment) directive. The WEEE Directive specifies the treatment, collection, recycling and disposal of electric and electronic devices and their components. Under the Directive, used equipment must be marked, collected separately, and disposed of properly.

WEEE Symbol Statement



The symbol shown below is on the product or on its packaging, which indicates that this product must not be disposed of with other waste. Instead, the device should be taken to the waste collection centers for activation of the treatment, collection, recycling and disposal procedure.

For more information about where you can drop off your waste equipment for recycling, please contact your local government office, your household waste disposal service or where you purchased the product for details of environmentally safe recycling.

Safety Precautions

Read through the following *Safety Precautions* before using the monitor.

- Only use the accessories that are provided with the monitor or that which are recommended by the manufacturer.
- Keep the plastic packaging bag for the product in a place that cannot be reached by children.
- Before connecting the monitor to the power outlet, make sure that the voltage rating of the power cable is compatible with the power specification in the country where you are located.
- The power cord plug must be connected to a properly wired and grounded power outlet.
- Do not touch the plug with wet hands, otherwise easily cause electric shock.
- Place the monitor in a stable and well-ventilated place.
- Do not place the monitor near any heat sources such as electric radiators or direct sunlight.
- The holes or openings on the monitor are for ventilation. Do not cover or block the ventilation holes with any objects.
- Do not use the monitor near water, drinks, or all types of liquids. Failure to do so may result in electric shock or damage to the monitor.
- Make sure to unplug the monitor from the power outlet before cleaning.
- As the screen surface is easy to be scratched, avoid touching the surface with any hard or sharp object.
- Use a soft lint-free cloth instead of a tissue to wipe the screen. You may use a glass cleaner to clean the monitor if required. However, never spray the cleaner directly onto the screen.
- Disconnect the power cable if the monitor is not being used for a long period of time.
- Do not attempt to disassemble or repair the monitor yourself.

CONTENTS

Safety Information	3
Regulatory Notices	3
Safety Precautions	5
Introduction	7
Unpacking	7
Package Contents	9
Product Overview	10
Getting Started.....	12
Installing the Monitor Base	12
Adjusting the Viewing Angle.....	14
Installing a Wall-Mount Bracket (Optional)	16
Making Connections	18
Using the Device.....	19
Turning the Power On/Off	19
Managing the Cables	20
User Comfort Recommendations	20
Selecting the Input Source.....	21
Operations	22
Quick Menu.....	22
Configure the Device Settings	27
Appendices.....	37
Specifications	37
Supported Timing List.....	38
Troubleshooting.....	39
Basic Care.....	40
Notes on USB Charging	40
GIGABYTE Service Information	40

INTRODUCTION

Unpacking

1. Open the upper cover of the packaging box. Then observe the unpacking label attached on the inner cover.
2. Making sure the box is in the correct orientation, carefully lay the box on the stable surface.

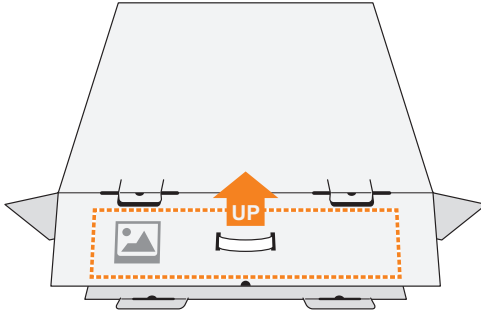

3. Open the inner cover.

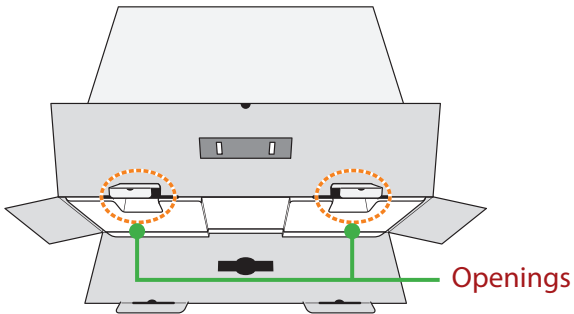

4. Grab the EPS foam assembly (through the openings) to pull it out of the box.

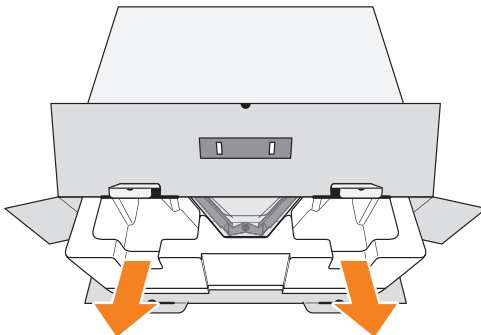

5. Remove the items from the upper EPS foam.

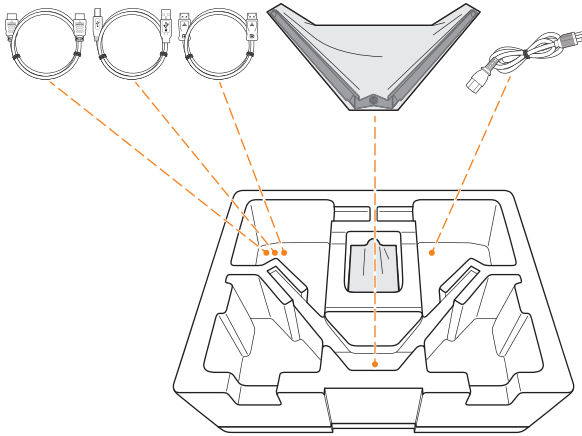

6. Remove the upper EPS foam. Then you can remove the monitor from the lower EPS foam.

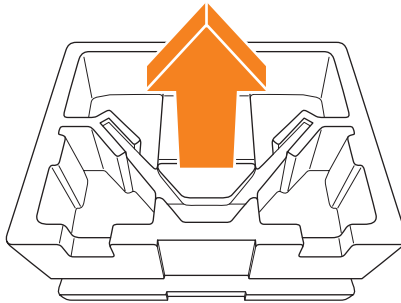

Package Contents

The following items come with your packaging box. If any of them is missing, please contact your local dealer.

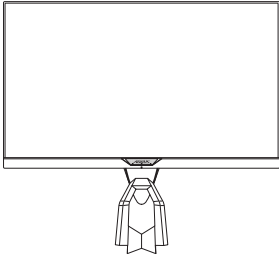

Monitor

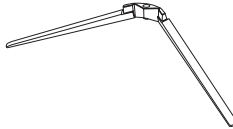

Monitor Base

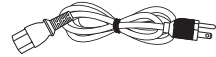

Power Cable

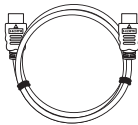

HDMI Cable

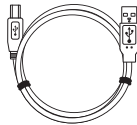

USB Cable

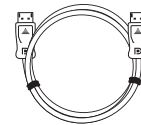

DP Cable



Cable Holder



Quick Start Guide



Warranty Card



CD

Note: Please keep the packaging box and packing materials for future transportation of the monitor.

Product Overview

Front View

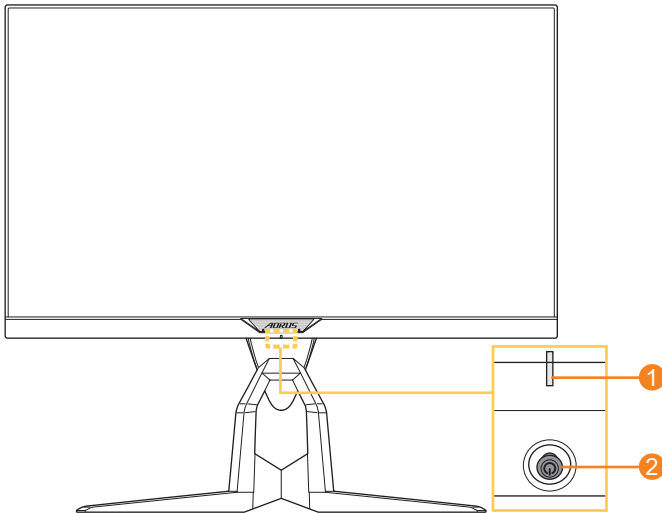

1 Power LED

2 Control button

Rear View

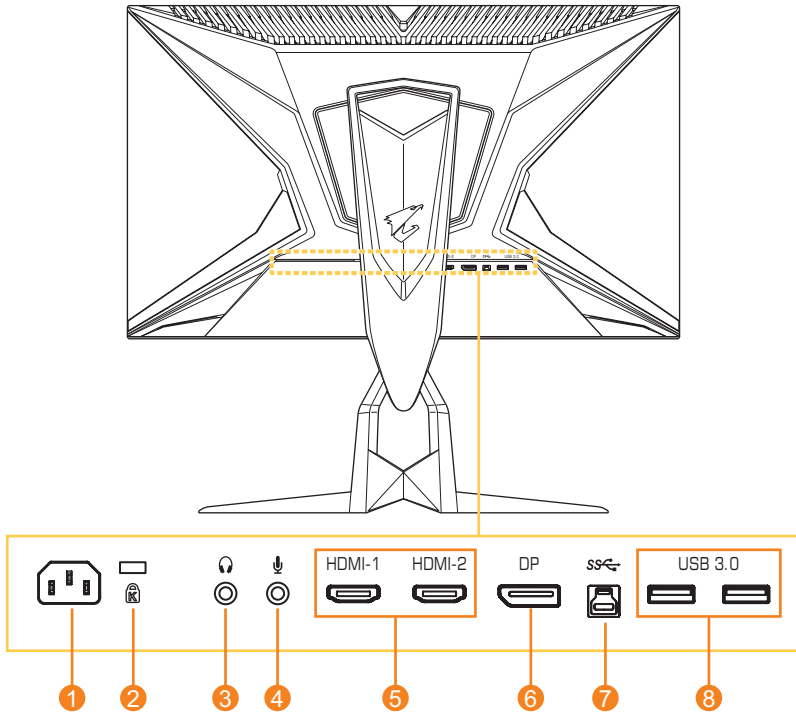

1 AC IN jack

2 Kensington lock

3 Headphone jack

4 Microphone jack

5 HDMI ports (x2)

6 DisplayPort

7 USB upstream port

8 USB 3.0 ports (x2)

GETTING STARTED

Installing the Monitor Base

1. Place the monitor on a flat surface, with the screen facing down.

Note: We recommend that you cover the table surface with soft cloth to prevent damage to the monitor.

2. Align the monitor base with the standoff underneath the stand. Then attach the base onto the stand.

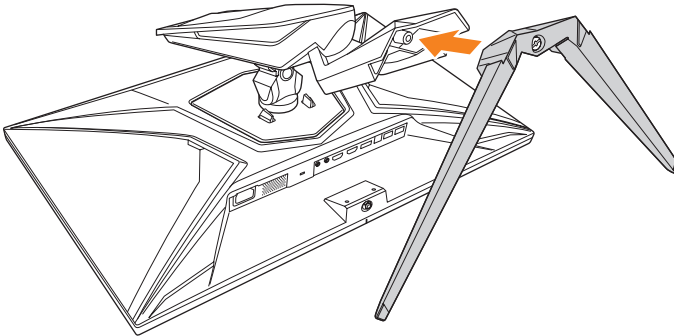

3. Tighten the screw to secure the monitor base in place.

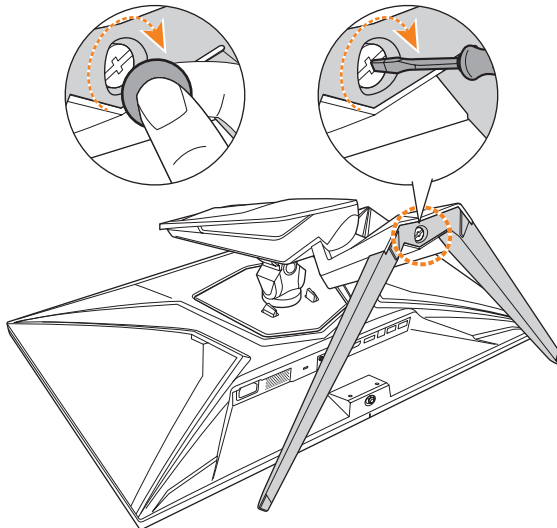

Note: You can either use a coin or a small flathead screwdriver to tighten the screw.

4. Lift the monitor to an upright position and place it on a table. Then lower the screen to allow the safety plate to automatically release from its slot.

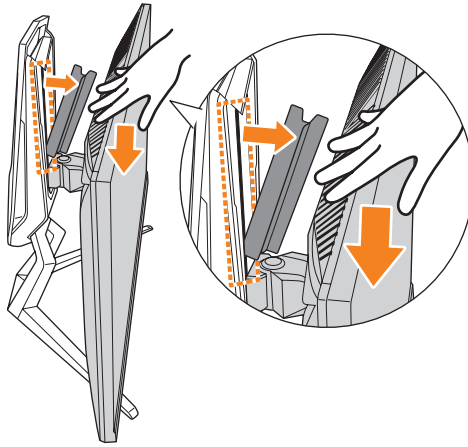

Adjusting the Viewing Angle

Note: Hold the monitor base so that the screen does not topple when you make the adjustment.

Adjusting the Tilt Angle

Tilt the screen forward or backward to the desired viewing angle (-5° to 21°).

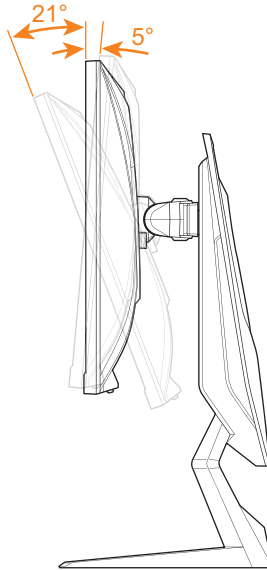

Adjusting the Swivel Angle

Swivel the screen to the left or right for the desired viewing angle (20°).

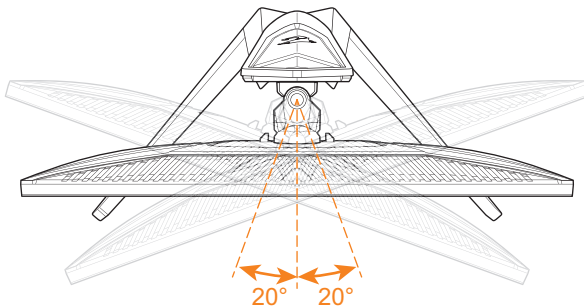

Changing the Screen Orientation

1. Raise the screen to the highest position (130mm).

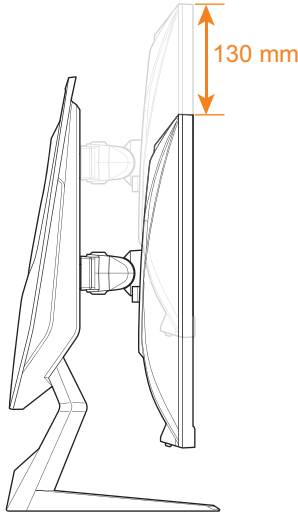

Note: Before making the height adjustment, make sure you have removed the safety plate from the stand.

2. Rotate the monitor (90° clockwise) to portrait orientation.

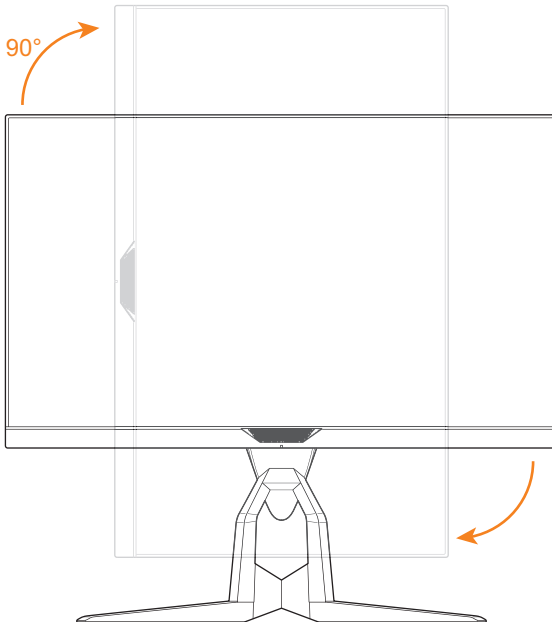

Installing a Wall-Mount Bracket (Optional)

Use only the 100 x 100 mm wall mount kit recommended by the manufacturer.

1. Place the monitor on a flat surface, with the screen facing down.

Note: We recommend that you cover the table surface with soft cloth to prevent damage to the monitor.

2. Push the locking clips inward to detach the stand from the monitor.

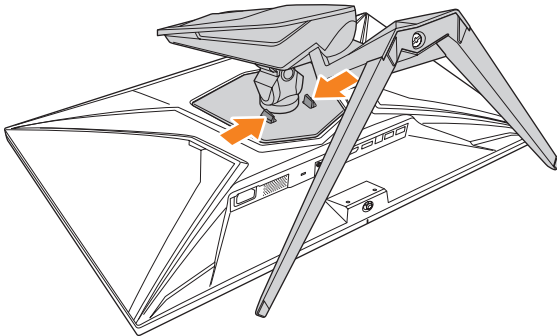

3. Pull down the stand slightly to disengage the hooks. Then remove the stand.

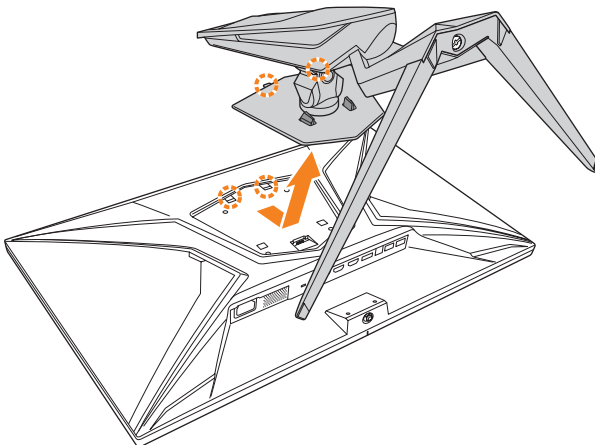

4. Attach the mounting bracket to the mounting holes at the rear of the monitor. Then use the screws to secure the bracket in place.

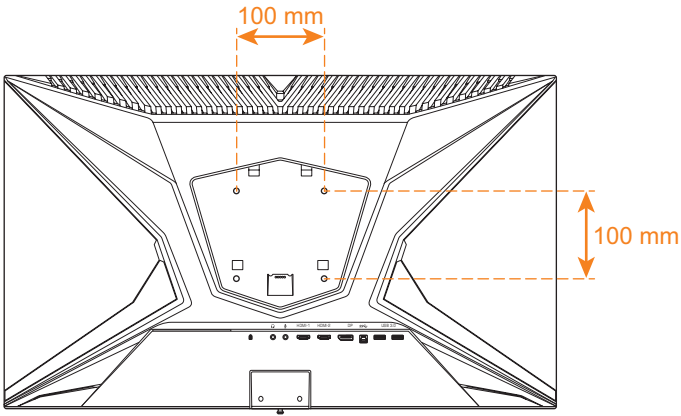

Note: To mount the monitor on the wall, refer to the installation guide that is included in the wall-mount bracket kit.

Making Connections

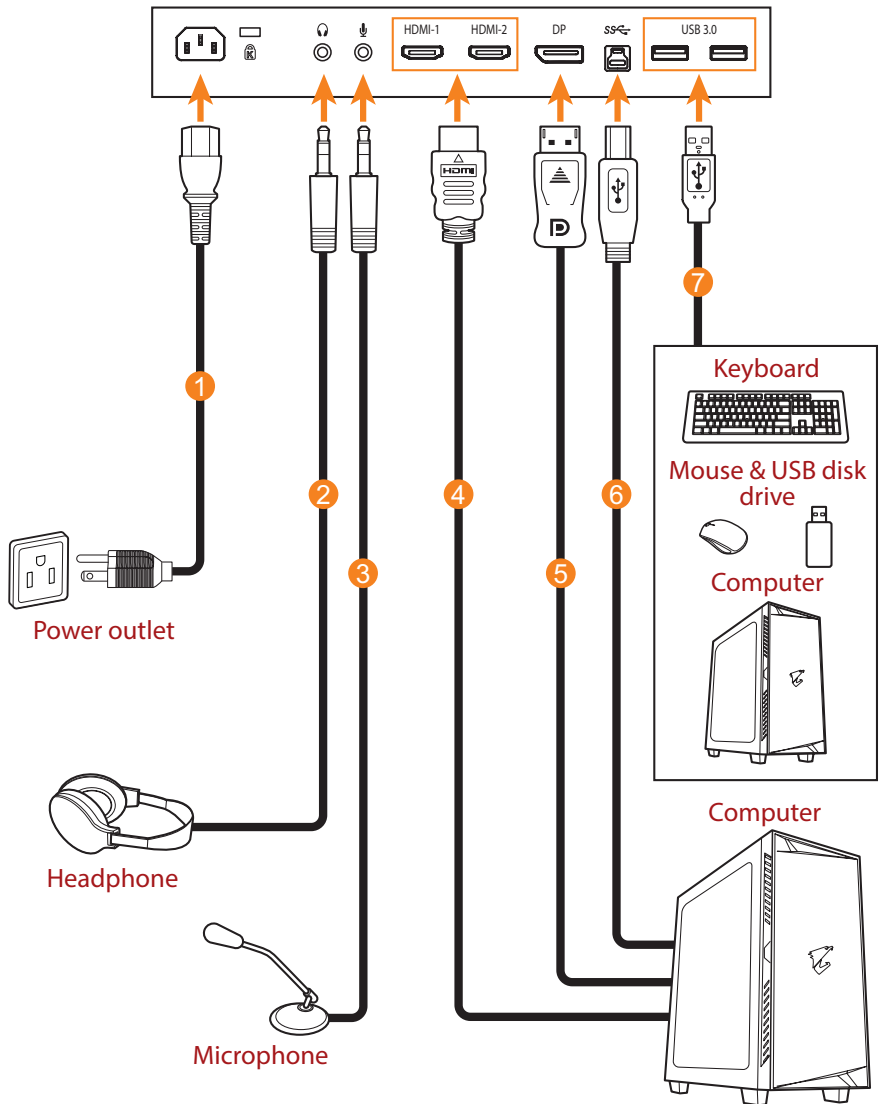

- 1** Power cable
- 2** Headphone cable
- 3** Microphone cable
- 4** HDMI cable

- 5** DisplayPort cable
- 6** USB (A-Male to B-Male) cable
- 7** USB cable

USING THE DEVICE

Turning the Power On/Off

Power On

1. Connect one end of the power cable to the AC IN jack at the rear of the monitor.
2. Connect other end of the the power cable to a power outlet.
3. Press the **Control** button to turn on the monitor. The Power LED will light in white, indicating the monitor is ready to use.

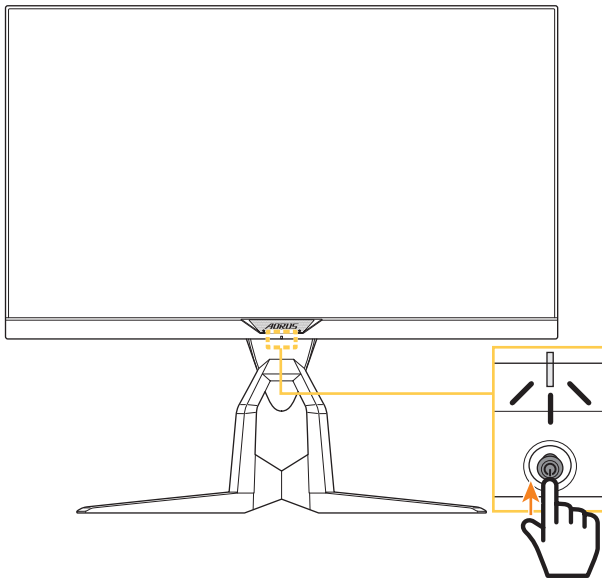

Note: If the Power LED remains off after you turn on the monitor, please check the **LED Indicator** setting in the **Settings** menu. Refer to page 34.

Power Off

Press the **Control** button for 2 seconds to turn off the monitor.

Note: When the **Main** menu appears on the screen, you can also turn off the monitor by moving the **Control** button down (). Refer to page 24.

Managing the Cables

1. Align the cable clip with the clip holes at the rear of the monitor.
2. Press the cable clip firmly until it is fully seated. Then route the connected cables through the clip.

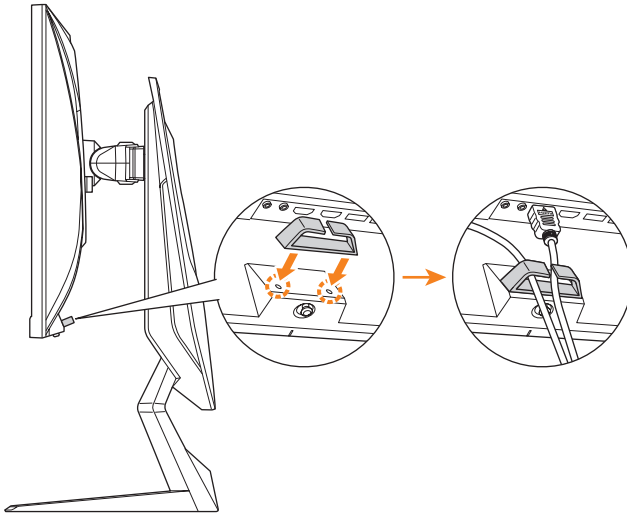

User Comfort Recommendations

The following are some tips for comfortable viewing of your monitor:

- Optimal viewing distances for monitors range from approximately 510 mm to 760 mm (20" to 30").
- A general guideline is to position the monitor such that the top of the screen is at or slightly below your eye-height when you are comfortably seated.
- Use adequate lighting for the type of work you are performing.
- Take regular and frequent breaks (at least for 10 minutes) every half-hour.
- Be sure to periodically look away from your monitor screen and focus on a far object for at least 20 seconds during the breaks.
- Eye exercise can help reduce eye strain. Repeat these exercises frequently: (1) look up and down (2) slowly roll your eye (3) move your eyes diagonally.

Selecting the Input Source

1. Move the **Control** button right (⏪) to enter the **Input** menu.
2. Move the **Control** button up/down (⏩) to select the desired input source. Then press the **Control** button to confirm.

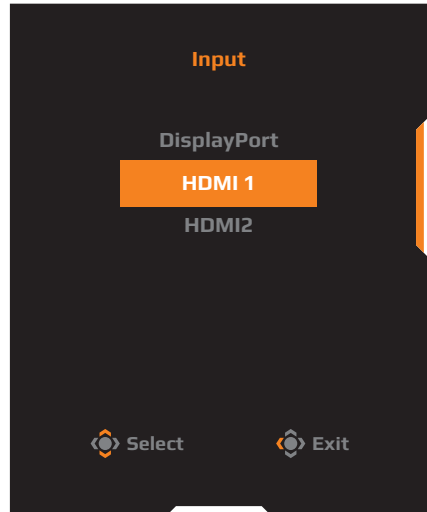

OPERATIONS

Quick Menu

Hot Key

By default, the **Control** button has been assigned with the specific function.

Note: To change the preset hot key function, refer to the “Quick Switch” section on page 34.

To access the hot key function, do the following:

- Move the **Control** button up (⬅️⬆️) to enter the **Black Equalizer** menu.

Move the **Control** button up/down (⬅️⬆️) to adjust the setting and press the **Control** button to confirm.

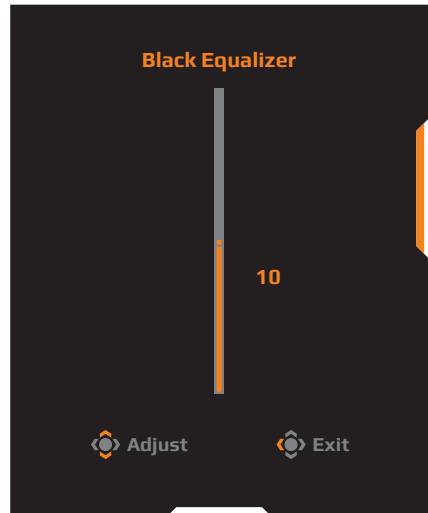

- Move the **Control** button down () to enter the **Picture Mode** menu.

Move the **Control** button up/down () to select the desired option and press the **Control** button to confirm.

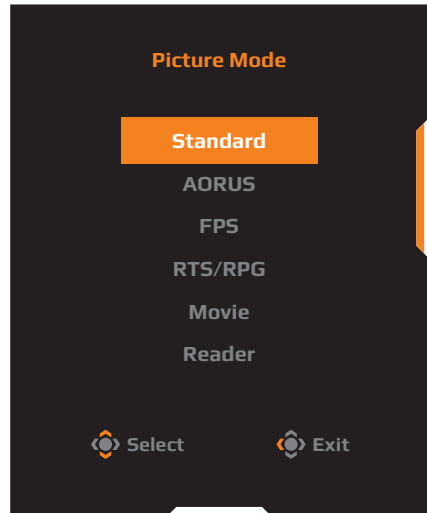

- Move the **Control** button left () to enter the **Volume** menu.

Move the **Control** button up/down () to adjust the headphone volume level and press the **Control** button to confirm.

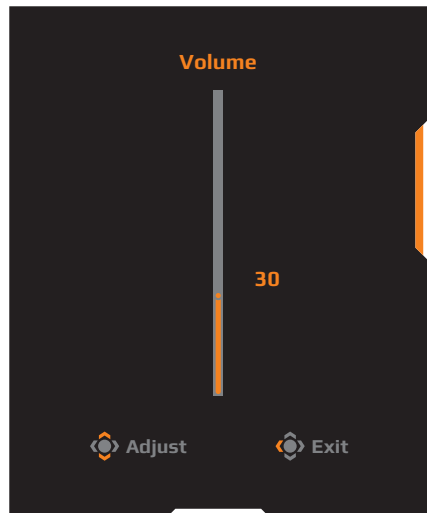

- Move the **Control** button right () to enter the the **Input** menu. Refer to the “Selecting the Input Source” section.

Note: To close the menu, move the **Control** button left ().

Function Key Guide

Press the **Control** button to display the **Main** menu.

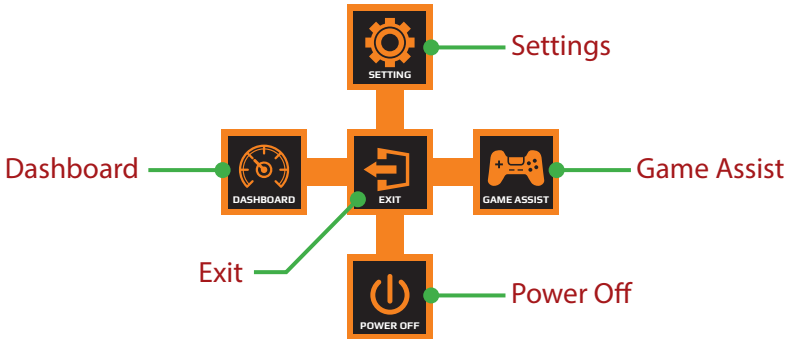

Then use the **Control** button to select the desired function and configure the related settings.

Dashboard

When the **Main** menu appears on the screen, move the **Control** button left (◀) to enter the **Dashboard** menu.

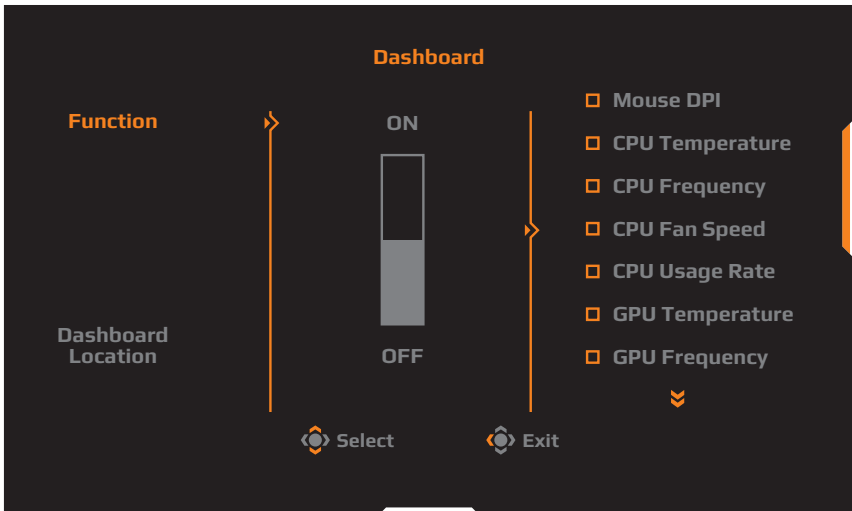

- **Function:** Enable/Disable the function. When enabled, you can select the desired option(s) to be shown on the screen.
- **Dashboard Location:** Specify the location of the Dashboard information to be shown on the screen.

Once the Dashboard configuration is complete, it will transfer the system data to the SOC through the USB port and display the value of the selected function(s) on the screen.



Note: Make sure the USB cable is properly connected to the USB upstream port of the monitor and the USB port of your computer.

Game Assist

When the **Main** menu appears on the screen, move the **Control** button right () to enter the **Game Assist** menu.

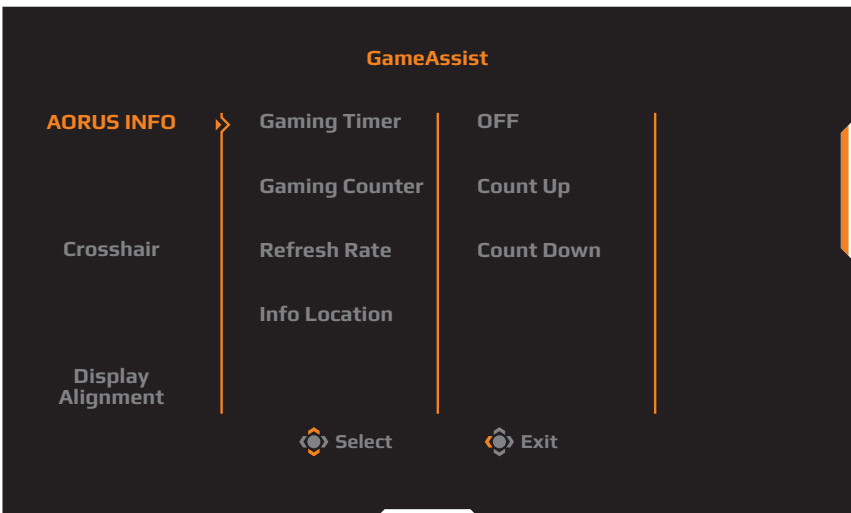

- **AORUS INFO:** Configure the FPS (First Person Shooting) game related settings.
 - ✓ Select **Gaming Timer** to select countdown timer mode. To disable this function, set the setting to **OFF**.
 - ✓ Select **Gaming Counter** or **Refresh Rate** to enable/disable the gaming counter or real-time refresh rate setting.
 - ✓ Select **Info Location** to specify the location of the information to be shown on the screen.



- **Crosshair:** Select the desired crosshair type to suit your gaming environment. It makes aiming much easier.
- **Display Alignment:** When the function is enabled, it displays the alignment lines on the four sides of the screen, providing handy tool for you to line up multiple monitors perfectly.

Configure the Device Settings

When the **Main** menu appears on the screen, move the **Control** button up (⬆️) to enter the **Settings** menu.

Note: Use the **Control** button to navigate through the menu and make adjustments.

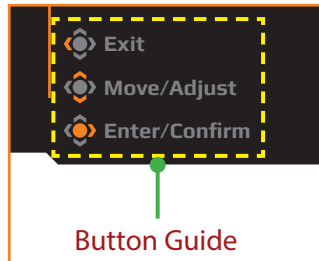

Gaming

Configure the game related settings.

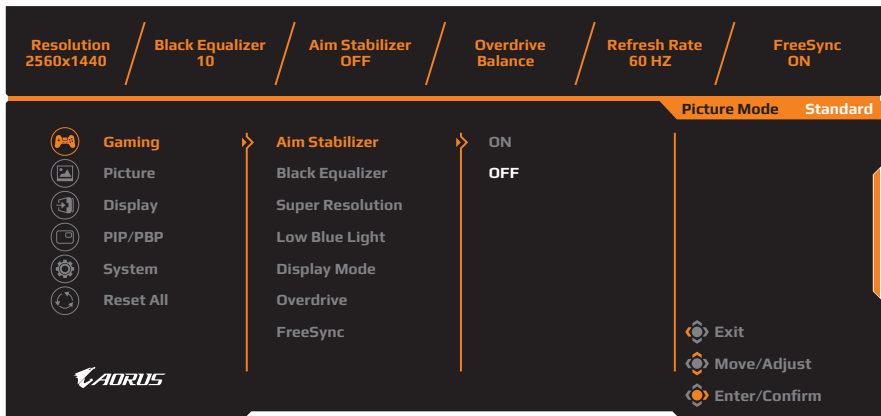

Item	Description
Aim Stabilizer	<p>When this function is enabled, it reduces the motion blur in a fast moving games.</p> <p>Note: This function is not available under the following conditions:</p> <ul style="list-style-type: none"> - when the frequency setting is lower than 75Hz. - when the FreeSync, PIP, or PBP function is activated.

Item	Description
Black Equalizer	Adjust the brightness of the black areas.
Super Resolution	Sharpen the low resolution images.
Low Blue Light	<p>Reduce the amount of blue light exposure from the screen.</p> <ul style="list-style-type: none"> • Level 0: No change. • Level 1~10: The higher the level, the more blue light will be reduced. <p>Note: Level 10 is optimized setting. It is compliance with TUV Low Blue Light Certification.</p>
Display Mode	<p>Select the aspect ratio of the screen.</p> <ul style="list-style-type: none"> • Full: Scale the input image to fill the screen. Ideal for 16:9 aspect images. • Aspect: Display the input image without geometric distortion filling as much of the screen as possible. • 1:1: Display the input image in its native resolution without scaling. • 22"W (16:10): Display the input image as if on a 22"W monitor of 16:10 aspect ratio. • 23"W (16:9): Display the input image as if on a 23"W monitor of 16:9 aspect ratio. • 23.6"W (16:9): Display the input image as if on a 23.6"W monitor of 16:9 aspect ratio. • 24"W (16:9): Display the input image as if on a 24"W monitor of 16:9 aspect ratio. <p>Note: This option is not compatible with FreeSync and PIP/PBP functions.</p>
Overdrive	Improve the response time of the LCD monitor.
FreeSync	When this function is enabled, it eliminates the screen lag and tearing while playing games.

Picture

Configure the image related settings.

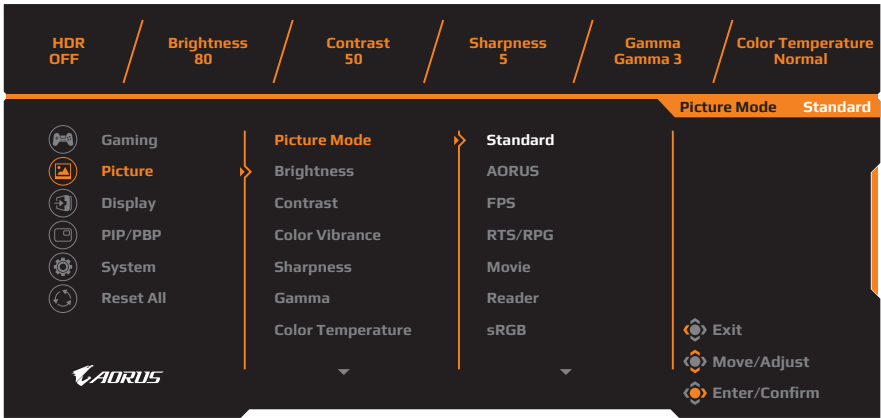

Item	Description
Picture Mode	<p>Select the preset picture mode.</p> <ul style="list-style-type: none"> Standard: For editing documents or browsing websites. AORUS: For playing AORUS GAMER games. FPS: For playing FPS (First Person Shooting) games. RTS/RPG: For playing RTS (Real-Time Strategy) or RPG (Role-Playing Game) games. Movie: For watching movies. Reader: For viewing documents. sRGB: For viewing photos and graphics on the computer. Custom 1: Customized picture mode settings. Custom 2: Customized picture mode settings. Custom 3: Customized picture mode settings.
Brightness	Adjust the brightness of the image.
Contrast	Adjust the contrast of the image.
Color Vibrance	Adjust the intensity of the more muted colors.
Sharpness	Adjust the sharpness of the image.
Gamma	Adjust the middle level of luminance.

Item	Description
Color Temperature	Select the color temperature. Note: Select User Define to customize the color temperature by adjusting the red (R), green (G), or blue (B) level according to your preference.
Dynamic Contrast	Adjust the black level of the image to achieve the optimum contrast.
Senseye Demo	Split the screen in half (2 windows). The image of Standard mode will appear on the left window and the image under the specified mode will appear on the right window.
Reset Picture	Reset all Picture settings to the default settings.

Display

Configure the display screen related settings.

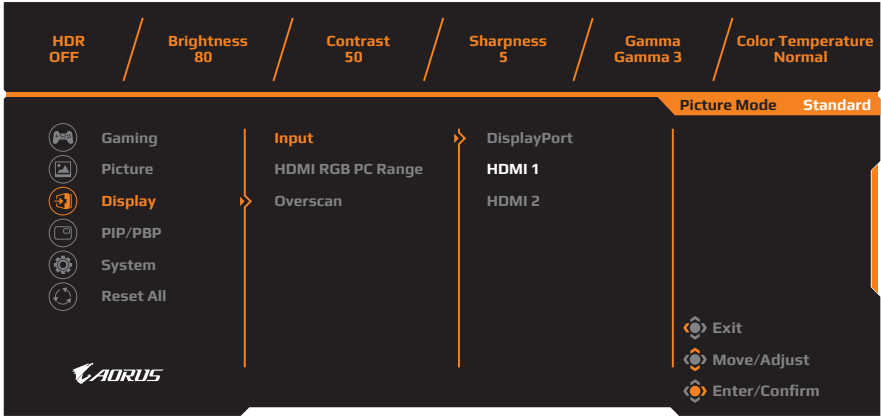

Item	Description
Input	Select the input source.
HDMI RGB PC Range	Select an appropriate RGB range setting or let the monitor to detect it automatically. Note: This option is only available for HDMI input.
Overscan	When this function is enabled, it slightly enlarges the input image to hide the outermost edges of the image. Note: This option is only available for HDMI input.

PIP/PBP

Configure the multi-picture related settings.

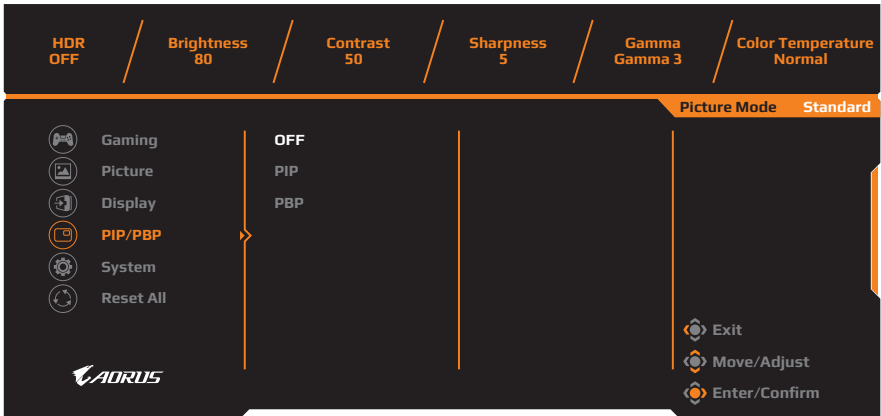

Item	Description
OFF	Disable the PIP/PBP function.
PIP	Split the screen into 2 parts (main window and inset window). <ul style="list-style-type: none"> • Source: Change the input source for the inset window. • PIP Size: Adjust the inset window size. • Location: Move the inset window position. • Display Switch: Swap the two windows. • Audio Switch: Select which audio source you want to hear the sound from.
PBP	Display 1x1 split screen (left and right windows). <ul style="list-style-type: none"> • Source: Change the input source for the right window. • Display Switch: Swap the two windows. • Audio Switch: Select which audio source you want to hear the sound from.

Note: PIP/PBP is not compatible with HDR and FreeSync functions.

System

Configure the system related settings.

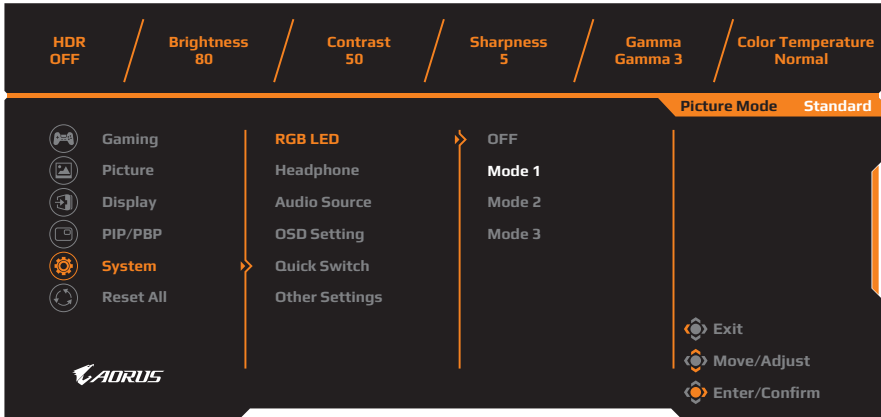

Item	Description
RGB LED	When this function is enabled, you can select the preset LED color and effect to be displayed on the rear of the monitor.
Headphone	Configure the headphone settings. <ul style="list-style-type: none"> Volume: Adjust the volume level. Mute: Enable/Disable the mute function.
Audio Source	Specify the audio input source or let the monitor to detect it automatically. <p>Note: If you select Auto detect, the system will check first whether the USB cable is connected or not. If it is connected, the audio input source is set to USB Codec.</p>
OSD Settings	Configure the on-screen display (OSD) menu related settings. <ul style="list-style-type: none"> Language: Select an available language for the OSD menu. Display Time: Set the length of time the OSD menu remains on the screen. OSD Transparency: Adjust the OSD menu transparency.

Item	Description
OSD Settings <i>(continue)</i>	<ul style="list-style-type: none"> OSD Lock: When this function is enabled, no OSD adjustment is allowed. Note: To disable the OSD lock function, press the Control key. When the message appears on the screen, select Yes to confirm. <div data-bbox="484 347 820 507" style="background-color: black; color: white; padding: 10px; text-align: center; margin: 10px auto; width: fit-content;"> <p>The button is locked, confirm to unlock OSD.</p> <p>No Yes</p> </div>
Quick Switch	Assign the function of the hot keys. Available options: Aim Stabilizer, Black Equalizer, Low Blue Light, Volume, Input, Contrast, Brightness, and Picture Mode. The default setting of the hot keys as below: <ul style="list-style-type: none"> ⇒ Up (⬆️): Black Equalizer ⇒ Down (⬆️): Picture Mode ⇒ Right (⬆️): Input ⇒ Left (⬆️): Volume
Other Settings	<ul style="list-style-type: none"> Resolution Notice: When this function is enabled, the recommended resolution message will appear on the screen when the monitor switches to another input source. Input Auto Switch: When this function is enabled, it automatically switches to an available input source. Auto Power Off: When this function is enabled, the monitor will automatically turn off after a certain amount of time.

Item	Description
Other Settings <i>(continue)</i>	<ul style="list-style-type: none"> • LED Indicator: By default, the LED indicator is set to ON. <ul style="list-style-type: none"> ⇒ LED Indicator OFF: Turn off the Power LED. ⇒ LED Indicator ON: The Power LED lights white during operation and lights orange in standby mode. ⇒ LED Indicator Friendly: The Power LED lights orange in standby mode. ⇒ When the power supply is switched off, the Power LED will remain off. • DisplayPort Ver.: Set the DisplayPort version to 1.1, 1.2, or 1.2+HDR. <p>Note:</p> <ul style="list-style-type: none"> • To enable the HDR effect for the DP port, you may need to set the DisplayPort version to 1.2+HDR and enable the 10-bit color output in your graphics card. • Make sure to configure this option based on the DisplayPort version supported by your graphics card.

Reset All

Restore the monitor to its factory default settings.

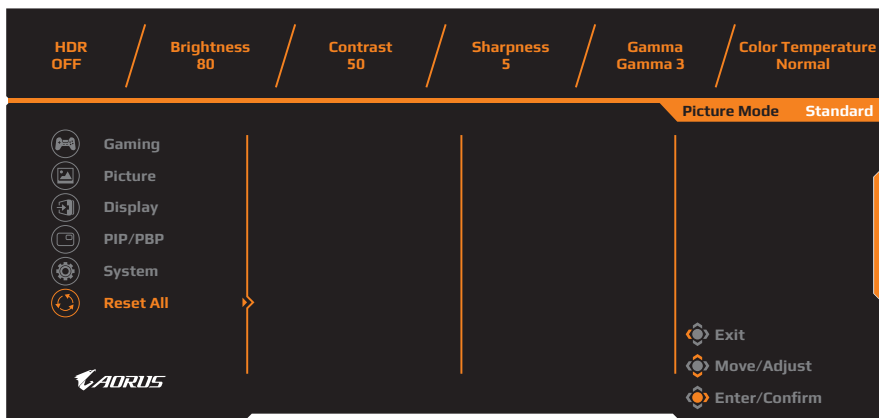

APPENDICES

Specifications

Item	Specifications
Panel Size	27-inch
Aspect Ratio	16:9
Resolution	2560 x 1440
Refresh Rate	144Hz
LED Life	30000 hours (min.)
Pixel Pitch	0.233 x 0.233
Response Time	1ms(MPRT)
Brightness	350nits (typ.) / 280nits (min.)
Contrast Ratio	1000:1 (typ.)
Dynamic Contrast Ratio	12M:1 (typ.)
Color Depth	1.073G
Active Display area	596.736(H) x 335.664(V)
Viewing Angle	178°(H) / 178°(V)
Frequency	30~144Hz
Input/Output Terminals	<ul style="list-style-type: none"> • 2x HDMI 2.0 • 1x DP 1.2 • 1x Headphone • 1x Microphone • 2x USB 3.0 (downstream) • 1x USB upstream
Power Supply	AC 100 ~ 240V at 50/60Hz
Power Consumptions	<ul style="list-style-type: none"> • On: 75W (Max.) • Standby: 0.5W • Off: 0.3W
Dimensions (W x H x D)	614.9 x 484.7 x 236.9 mm (with stand)
Weight	8.0kg (Net)

Note: Specifications subject to change without notice.

Supported Timing List

Timing List	HDMI 2.0	DisplayPort 1.2
640 x 480 @ 60Hz	√	√
640 x 480 @ 67Hz	√	√
640 x 480 @ 72Hz	√	√
640 x 480 @ 75Hz	√	√
720 x 400 @ 70Hz	√	√
800 x 600 @ 56Hz	√	√
800 x 600 @ 60Hz	√	√
800 x 600 @ 72Hz	√	√
800 x 600 @ 75Hz	√	√
832 x 624 @ 75Hz	√	√
1024 x 768 @ 60Hz	√	√
1024 x 768 @ 70Hz	√	√
1024 x 768 @ 75Hz	√	√
1152 x 864 @ 75Hz	√	√
1280 x 720 @ 50Hz	√	√
1280 x 720 @ 60Hz	√	√
1280 x 1024 @ 50Hz	√	√
1280 x 1024 @ 75Hz	√	√
1440 x 900 @ 60Hz	√	√
1680 x 1050 @ 60Hz	√	√
1920 x 1080 @ 50Hz	√	√
1920 x 1080 @ 60Hz	√	√
1920 x 1080 @ 100Hz	√	√
1920 x 1080 @ 120Hz	√	√
2560 x 1440 @ 60Hz	√	√
2560 x 1440 @ 120Hz	√	√
2560 x 1440 @ 144Hz	√	√

Troubleshooting

Problem	Possible Solution(s)
No power	<ul style="list-style-type: none"> • Make sure the power cable is properly connected to the power source and the monitor. • Check the cable and plug to make sure they are not broken. • Make sure the monitor is turned on.
No image appears on the screen	<ul style="list-style-type: none"> • Make sure the monitor and the computer are properly connected and both devices are turned on. • Make sure you have selected the correct input source. Refer to page 21 or 31. • Adjust the Brightness and Contrast settings. Refer to page 29.
The image does not fill the entire screen	<ul style="list-style-type: none"> • Try different Display Mode (aspect ratio) setting. Refer to page 28.
The colors are distorted	<ul style="list-style-type: none"> • Make sure the input signal cable is properly connected. • Configure the image related settings. Refer to the "Picture" section.
No sound or volume is low	<ul style="list-style-type: none"> • Make sure the headphone cable is properly connected. • Adjust the volume level. Refer to page 23 or 33. • Check the Audio Source setting. If the setting is set to USB Codec, make sure the USB cable is properly connected to the monitor and your computer. Refer to page 33. • Adjust your computer sound related settings.

Note: If the problem persists, please contact our customer service for further assistance.

Basic Care

When the screen becomes dirty, do the following to clean the screen:

- Wipe the screen with your soft, lint-free cloth to remove any residual dust.
- Spray or apply the cleaning fluid onto a soft cloth. Then wipe the screen gently with the damp cloth.

Note:

- Make sure that the cloth is damp, but not wet.
- When wiping, avoid applying excessive pressure on the screen.
- Acidic or abrasive cleaners can damage the screen.

Notes on USB Charging

The following devices are not compatible with BC 1.2 of CDP mode. When the Hub is connected to a PC, these devices cannot be charged using the USB cable.

Vendor	Device	PID/VID
Apple	iPad	PID_129A/VID_05AC
Samsung	Galaxy Tab2 10.1	PID_6860/VID_04E8
Samsung	GALAXY TabPro	PID_6860/VID_04E8

GIGABYTE Service Information

More service information, please visit GIGABYTE official website:
<https://www.gigabyte.com/>