

# SAMSUNG

# USER MANUAL

---

## Gaming Monitor

C49RG90SS\*

The color and the appearance may differ depending on the product, and the specifications are subject to change without prior notice to improve the performance.

The contents of this manual are subject to change without notice to improve quality.

© Samsung Electronics

Samsung Electronics owns the copyright for this manual.

Use or reproduction of this manual in parts or entirety without the authorization of Samsung Electronics is prohibited.

Trademarks other than that of Samsung Electronics are owned by their respective owners.

---

(For India Only)

This product is RoHS compliant.

For more information on safe disposal and recycling visit our website [www.samsung.com/in](http://www.samsung.com/in) or contact our Helpline numbers-1800 40 SAMSUNG(1800 40 7267864) (Toll-Free)

---

---

# Table of contents

## Before Using the Product

Securing the Installation Space	4
Precautions for storage	4
<b>Safety Precautions</b>	<b>4</b>
Cleaning	5
Electricity and Safety	5
Installation	6
Operation	7

## Preparations

<b>Parts</b>	<b>9</b>
Control Panel	9
Function Key Guide	10
Game Setting Key	11
Changing Brightness, Contrast and Sharpness settings	12
Changing Eye Saver Mode settings	12
Changing the Volume setting	12
Types of Ports	13
Upgrading the Software via USB	14
Adjusting the Product Tilt and Height	16
Anti-theft Lock	17
<b>Installation</b>	<b>18</b>
Attaching the Stand	18
Removing the Stand (For Attaching the BRACKET WALL)	19
Attaching the BRACKET WALL	20

## Connecting and Using a Source Device

<b>Pre-connection Checkpoints</b>	<b>21</b>
<b>Connecting and Using a PC</b>	<b>21</b>
Connection Using the HDMI Cable	21
Connection Using the DP Cable	21
Connecting to Headphones	22
Connecting to Microphone	22
Connection Using the Audio Cable	22
<b>Connecting the Product to a PC as a USB HUB</b>	<b>23</b>
Connecting a PC to the Product	23
Utilizing the Product as a USB HUB	23
Connecting a USB device	24
Connecting the Power	25
Tidying Up the Connected Cables	26
<b>Correct posture to use the product</b>	<b>27</b>
<b>Driver Installation</b>	<b>27</b>
<b>Setting Optimum Resolution</b>	<b>27</b>

## Game

Picture Mode	28
Refresh Rate	29
Black Equalizer	30
Response Time	30
FreeSync	30
Low Input Lag	32
Virtual Aim Point	32
Screen Size	32
Save Settings	33

## Picture

Picture Mode	34
Brightness	35
Contrast	35
Sharpness	35
Color	36
HDMI Black Level	36
Eye Saver Mode	36
Screen Adjustment	37
Calibration Report	37

---

# Table of contents

---

PBP	37
PBP Mode	37
Aspect Ratio	38
Screen1	38
Screen2	38
Sound Source	38

## OnScreen Display

---

Language	39
Display Time	39

## System

---

Self Diagnosis	40
Lighting	42
Local Dimming	42
Volume	42
Smart ECO Saving+	42
Off Timer Plus	42
PC/AV Mode	43
USB Super Charging	43
DisplayPort Ver.	44
HDMI Mode	44

---

Source Detection	44
Key Repeat Time	44
Power LED On	45
Reset All	45
Information	45

## Installing the Software

---

Easy Setting Box	47
Restrictions and Problems with the Installation	47
System Requirements	47

## Troubleshooting Guide

---

Requirements Before Contacting Samsung Customer Service Center	48
Testing the Product	48
Checking the Resolution and Frequency	48
Check the following.	48
Q & A	50

## Specifications

---

General	51
Standard Signal Mode Table	52

## Appendix

---

Responsibility for the Pay Service (Cost to Customers)	56
Not a product defect	56
A Product damage caused by customer's fault	56
Others	56

# Chapter 01

## Before Using the Product

### Securing the Installation Space

Ensure some space around the product for ventilation. An internal temperature rise may cause fire and damage the product. Be sure to allow the amount of space as shown below or greater when installing the product.

— The exterior may differ depending on the product.

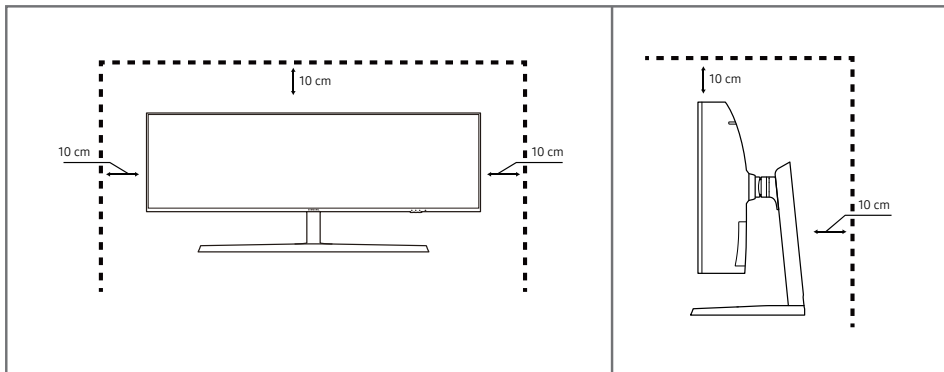

### Precautions for storage

High-glossy models can develop white stains on the surface if an ultrasonic wave humidifier is used nearby.

— Contact your nearest Samsung Customer Service Center if you want to clean the inside of the product (Service fee will be charged.)

### Safety Precautions

**Warning**

A serious or fatal injury may result if instructions are not followed.

**Caution**

Personal injury or damage to properties may result if instructions are not followed.

---

## Cleaning

— Take the following steps when cleaning.

- 1 Power off the product and computer.
- 2 Disconnect the power cord from the product.
  - Hold the power cable by the plug and do not touch the cable with wet hands. Otherwise, an electric shock may result.
- 3 Wipe the monitor with a clean, soft and dry cloth.
  - Do not apply a cleaning agent that contains alcohol, solvent, or surfactant to the monitor.
  - Do not spray water or detergent directly on the product.
- 4 Wet a soft and dry cloth in water and wring thoroughly to clean the exterior of the product.
- 5 Connect the power cord to the product when cleaning is finished.
- 6 Power on the product and computer.

---

## Electricity and Safety

### Warning

- Do not use a damaged power cord or plug, or a loose power socket.
- Do not use multiple products with a single power socket.
- Do not touch the power plug with wet hands.
- Insert the power plug all the way in so it is not loose.
- Connect the power plug to a grounded power socket (type 1 insulated devices only).
- Do not bend or pull the power cord with force. Be careful not to leave the power cord under a heavy object.
- Do not place the power cord or product near heat sources.
- Clean any dust around the pins of the power plug or the power socket with a dry cloth.

### Caution

- Do not disconnect the power cord while the product is being used.
- Only use the power cord provided with your product by Samsung. Do not use the power cord with other products.
- Keep the power socket where the power cord is connected unobstructed.
  - The power cord must be disconnected to cut off power to the product when an issue occurs.
- Hold the plug when disconnecting the power cord from the power socket.

---

## Installation

### Warning

- DO NOT PLACE CANDLES, INSECT REPELLANTS OR CIGARETTES ON TOP OF THE PRODUCT. DO NOT INSTALL THE PRODUCT NEAR HEAT SOURCES.
- Do not install the product in poorly ventilated spaces such as a bookcase or closet.
- Install the product at least 10cm away from the wall to allow ventilation.
- Keep the plastic packaging out of the reach of children.
  - Children may suffocate.
- Do not install the product on an unstable or vibrating surface (insecure shelf, sloped surface, etc.)
  - The product may fall and become damaged and/or cause an injury.
  - Using the product in an area with excess vibration may damage the product or cause a fire.
- Do not install the product in a vehicle or a place exposed to dust, moisture (water drips, etc.), oil, or smoke.
- Do not expose the product to direct sunlight, heat, or a hot object such as a stove.
  - The product lifespan may be reduced or a fire may result.
- Do not install the product within the reach of young children.
  - The product may fall and injure children.
- Edible oil, such as soybean oil, can damage or deform the product. Do not install the product in a kitchen or near a kitchen counter.

### Caution

- Do not drop the product while moving.
- Do not set down the product on its front.
- When installing the product on a cabinet or shelf, make sure that the bottom edge of the front of the product is not protruding.
  - The product may fall and become damaged and/or cause an injury.
  - Install the product only on cabinets or shelves of the right size.
- Set down the product gently.
  - Product failure or personal injury may result.
- Installing the product in an unusual place (a place exposed to a lot of fine dust, chemical substances, extreme temperatures or a significant presence of moisture, or a place where the product will operate continuously for an extended period of time) may seriously affect its performance.
  - Be sure to consult Samsung Customer Service Center if you want to install the product at such a place.

---

## Operation

### Warning

- There is a high voltage inside the product. Never disassemble, repair or modify the product yourself.
  - Contact Samsung Customer Service Center for repairs.
- To move the product, first disconnect all the cables from it, including the power cable.
- If the product generates abnormal sounds, a burning smell or smoke, disconnect the power cord immediately and contact Samsung Customer Service Center.
- Do not let children hang from the product or climb on top of it.
  - Children may become injured or seriously harmed.
- If the product is dropped or the outer case is damaged, turn off the power and disconnect the power cord. Then contact Samsung Customer Service Center.
  - Continued use can result in a fire or electric shock.
- Do not leave heavy objects or items that children like (toys, sweets, etc.) on top of the product.
  - The product or heavy objects may fall as children try to reach for the toys or sweets resulting in a serious injury.
- During a lightning or thunderstorm, power off the product and remove the power cable.
- Do not drop objects on the product or apply impact.
- Do not move the product by pulling the power cord or any cable.
- If a gas leakage is found, do not touch the product or power plug. Also, ventilate the area immediately.
- Do not lift or move the product by pulling the power cord or any cable.
- Do not use or keep combustible spray or an inflammable substance near the product.
- Ensure the vents are not blocked by tablecloths or curtains.
  - An increased internal temperature may cause a fire.
- Do not insert metallic objects (chopsticks, coins, hairpins, etc) or objects that burn easily (paper, matches, etc) into the product (via the vent or input/output ports, etc).
  - Be sure to power off the product and disconnect the power cord when water or other foreign substances have entered the product. Then contact Samsung Customer Service Center.
- Do not place objects containing liquid (vases, pots, bottles, etc) or metallic objects on top of the product.
  - Be sure to power off the product and disconnect the power cord when water or other foreign substances have entered the product. Then contact Samsung Customer Service Center.

---

## Caution

- Leaving the screen fixed on a stationary image for an extended period of time may cause afterimage burn-in or defective pixels.
  - Activate power-saving mode or a moving-picture screen saver if you will not be using the product for an extended period of time.
- Disconnect the power cord from the power socket if you do not plan on using the product for an extended period of time (vacation, etc).
  - Dust accumulation combined with heat can cause a fire, electric shock or electric leakage.
- Use the product at the recommended resolution and frequency.
  - Your eyesight may deteriorate.
- Do not hold the product upside-down or move it by holding the stand.
  - The product may fall and become damaged or cause an injury.
- Looking at the screen too close for an extended period of time can deteriorate your eyesight.
- Do not use humidifiers or stoves around the product.
- Rest your eyes for more than 5 minutes or look at distance objects for every 1 hour of product use.
- Do not touch the screen when the product has been turned on for an extended period of time as it will become hot.
- Store small accessories out of the reach of children.
- Exercise caution when adjusting the product angle or stand height.
  - Your hand or finger may get stuck and injured.
  - Tilting the product at an excessive angle may cause the product to fall and an injury may result.
- Do not place heavy objects on the product.
  - Product failure or personal injury may result.
- When using headphones or earphones, do not turn the volume too high.
  - Having the sound too loud may damage your hearing.
- Do not drop the product while moving.
  - Product failure or personal injury may result.



# Chapter 02

## Preparations

### Parts

#### Control Panel

The color and shape of parts may differ from what is shown. Specifications are subject to change without notice to improve quality.

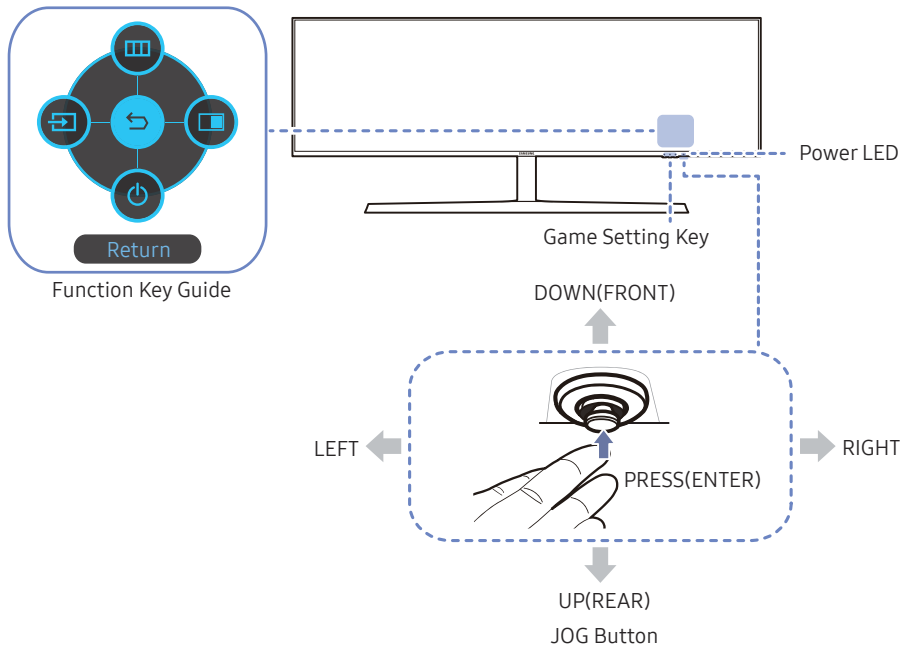

Parts	Description
JOG Button	Multi directional button that helps navigate. The JOG button is located at the bottom right side of the screen and has 5 directions of UP, DOWN, LEFT, RIGHT, and PRESS (ENTER).
Power LED	This LED is power status indicator and works as <ul style="list-style-type: none"> <li>Power On (Power button): Off</li> <li>Power saving mode: Blinking</li> <li>Power Off (Power button): On</li> </ul> The power Indicator operation can be swapped by changing in the menu. (System → Power LED On) Actual models because of functional variation maybe haven't this function.
Function Key Guide	Press the JOG button when the screen is turned on. The Function Key Guide will appear. To access the onscreen menu when the guide is displayed, press the corresponding direction button again. Function Key Guide may vary depending on the function or product model. Please refer to the actual product.
Game Setting Key	Use shortcut keys to access previously saved custom game modes. <ul style="list-style-type: none"> <li>Game Setting 1 / Game Setting 2 / Game Setting 3</li> </ul> The Game Setting Keys are located at the bottom right on the front of the monitor. To edit and save a custom game mode, go to Game → Save Settings.





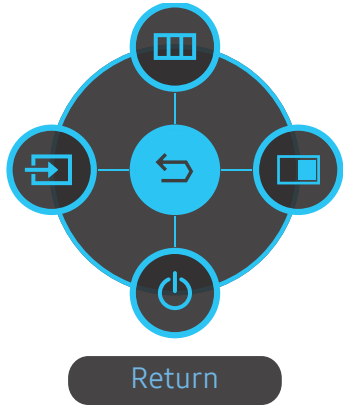



## Function Key Guide

To enter the main menu or to use other items, press the JOG button to display the Function Key Guide. You can exit by pressing the JOG button again.



UP/DOWN/LEFT/RIGHT: Move to the item you want. The description for each item will appear when the focus changes.

PRESS(ENTER): The selected item will be applied.

Icons	Description
 <b>Menu</b>	Selects  by moving the JOG button in the function key guide screen. The OSD (On Screen Display) of your Monitor's feature appears.
 <b>Source</b>	Selects  to change the input signal by moving the JOG button in the Function Key Guide screen. A message will appear on the top left corner of the screen if the input signal has been changed.
 <b>PBP</b>	Selects  by moving the JOG button in the function key guide screen. Press the button when configuring settings for the <b>PBP</b> function is required.
 <b>Power Off</b>	Selects  to turn the Monitor off by moving the JOG button in the function key guide screen.

Actual models because of functional variation, Function key guide options will be different.

When the monitor displays nothing (i.e. Power saving mode or Non-signal mode), 2 direct keys for control source and power could be used as below.

JOG Button	Power saving/Non-signal mode
UP	Source Change
Down	
PRESS(ENTER) for 2 seconds	Power Off

When the monitor displays the Main menu the JOG Button could be used as below.

JOG Button	Action
UP/DOWN	Move the option
LEFT	Exit the Main menu. Value decreases in the slider.
RIGHT	Move to next depth. Value increases in the slider.
PRESS(ENTER)	Move to next depth. Save the value and close Sublist.

## Game Setting Key

You can quickly view the setting with a shortcut key at the bottom without using an OSD menu. You can directly see the settings for three different modes.

- **Game Setting 1 / Game Setting 2 / Game Setting 3**

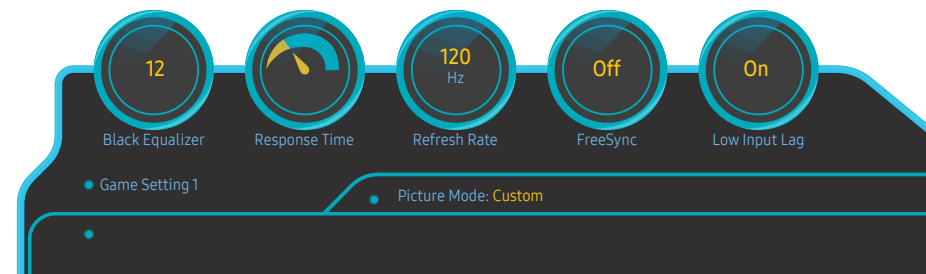
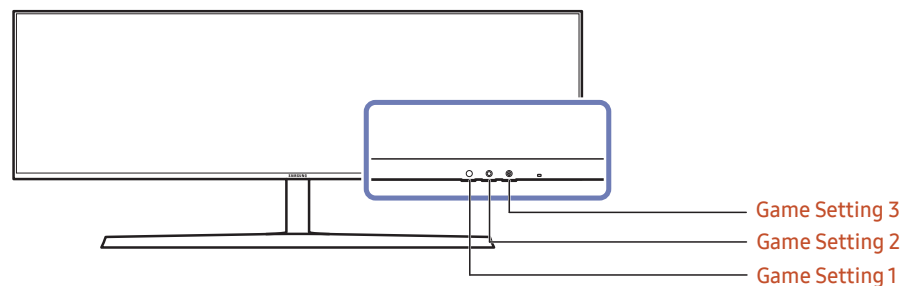

— The displayed image may differ depending on the model.

— The displayed images reflect the status of the functions as the settings in OSD of the corresponding functions other than the real-time values.

— This menu is not available when **PBP** is enabled.

---

## Changing Brightness, Contrast and Sharpness settings

You can adjust **Brightness**, **Contrast** or **Sharpness** by moving the JOG button up, if no OSD menu is displayed.

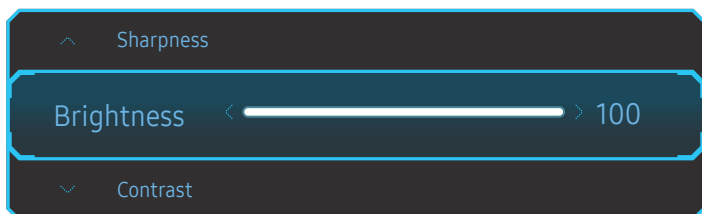

---

— The displayed image may differ depending on the model.

— The default brightness can vary depending on the region.

### Brightness

— This menu is not available when **Eye Saver Mode** is enabled.

— This menu is not available when **Picture Mode** is set to **Dynamic Contrast** mode.

### Contrast

— This menu is not available when **Picture Mode** is set to **Cinema** or **Dynamic Contrast** mode.

### Sharpness

— This menu is not available when **Picture Mode** is set to **Cinema** or **Dynamic Contrast** mode.

— This menu is not available when **PBP** is enabled.

## Changing Eye Saver Mode settings

You can adjust **Eye Saver Mode** by moving the JOG button down, if no OSD menu is displayed.

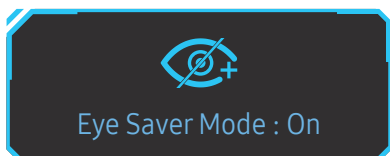

---

— The displayed image may differ depending on the model.

---

## Changing the Volume setting

You can adjust **Volume** by moving the JOG button left or right, if no OSD menu is displayed.



---

— The displayed image may differ depending on the model.

— If the audio quality of a connected input device is poor, the Auto Mute function on the product may mute the sound or cause choppy audio when applying the headphones or speakers. Set the input volume for the input device to at least 20% and control the volume using the volume control (JOG button LEFT/RIGHT) on the product.

— What is Auto Mute?

The function mutes the audio to improve sound effect when there is sound noise or when the input signal is weak, usually due to a problem with the volume of an input device.







— To activate the **Mute** function, access the **Volume** control screen, then use the JOG button to move the focus down.

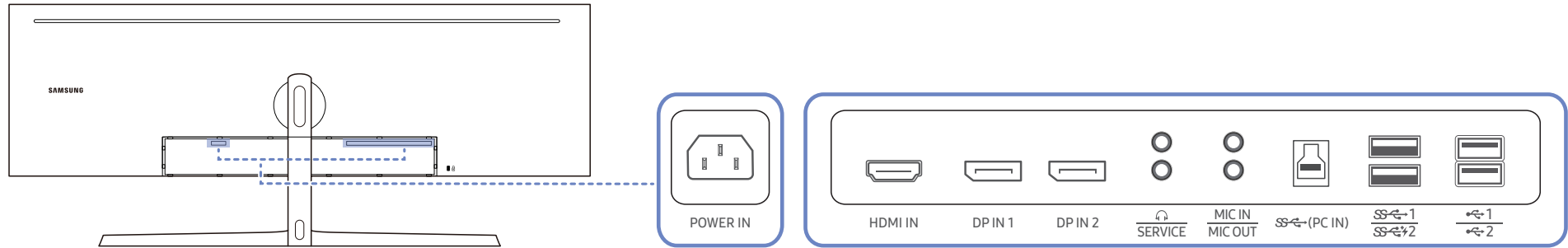



To deactivate the **Mute** function, access the **Volume** control screen, then increase or decrease the **Volume**.

## Types of Ports

— The functions available may vary depending on the product model. The color and shape of parts may differ from what is shown. Specifications are subject to change without notice to improve quality. Refer to the actual product.



Port	Description
 POWER IN	Connect the power cord for your monitor to the <b>POWER IN</b> port on the back of the product.
 HDMI IN	Connects to a source device using an HDMI cable or HDMI-DVI cable.
 DP IN 1    DP IN 2	Connects to a PC using a DP cable.
 SERVICE	Connect to an audio output device such as headphones.
 SERVICE	Dedicated to service technicians.
 MIC IN	Connect to a microphone.

Port	Description
 MIC OUT	Connect to a PC.
 SS-(PC IN)	Connects to a PC using a USB cable. Compatible with a USB cable version 3.0 or lower. — This port can only connect to a PC.
 SS-1 SS-2	Connect to a USB device. — Super charging is possible using the <b>SS-2</b> port only. This port charges devices faster than typical USB port. The speed depends on the connected devices.
 +1 +2	Connect to a USB device.

## Upgrading the Software via USB

- 1 Be sure to insert the USB disk into the SS-1 port. You can upgrade the software via USB only if either the monitor screen operates normally or the check signal is displayed on the monitor screen.

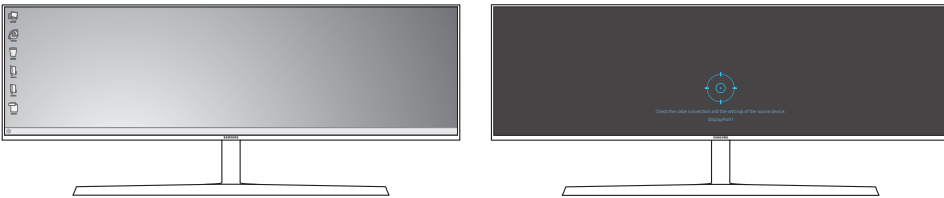
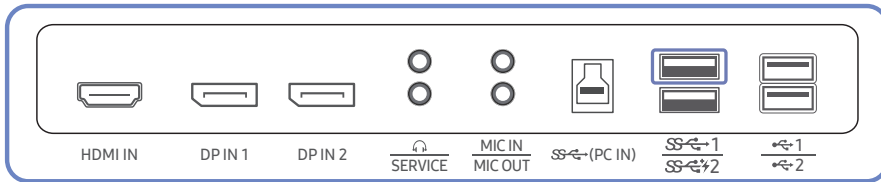

When the screen as shown in the following figure is displayed, press and hold the Down arrow key for 5 seconds.

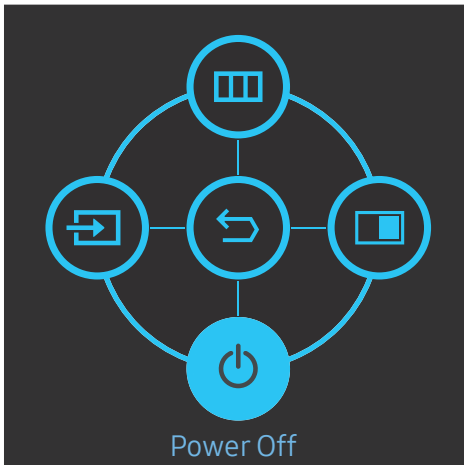

- 2 When the message as shown in the following figure is displayed on the monitor, select **Yes** to upgrade the software.

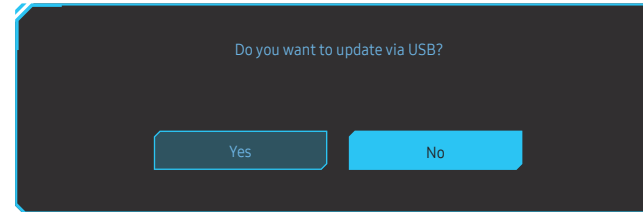

- 3 When the screen as shown in the following figure is displayed, select **Yes**.

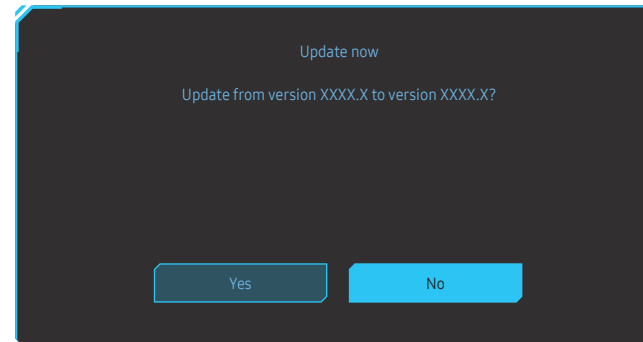

- 4 The software upgrading proceeds.

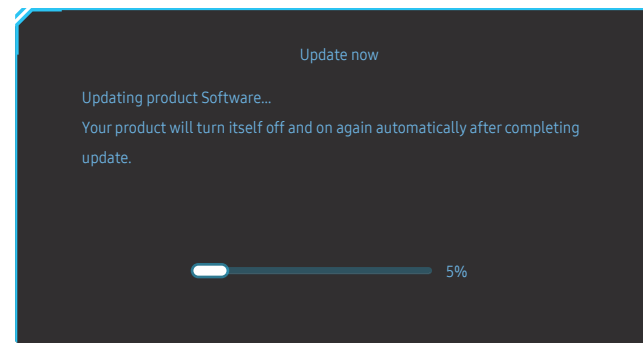

---

## Note

- 1 The supported USB disk formats are FAT, FAT32, and NTFS.
- 2 For the CRG9 model, make sure that each upgrade file is a BIN format file, follows the CRG9 model naming rule (m-RG949CCAA-\*\*\*.\*[4 digits].bin, where \*\*\*.\* is a version number, and 4 digits are a checksum. For example, “m-RG949CCAA-1000.0[6E80].bin” complies with the naming rule for the CRG9 model.), and must be copied to the root directory.
- 3 Make sure that the USB disk only contains one upgrade file for each model, and then follow the instructions in this guide.
- 4 If the **No valid update files found. Please check your USB device and try again.** message is displayed, this is probably due to the following reasons.

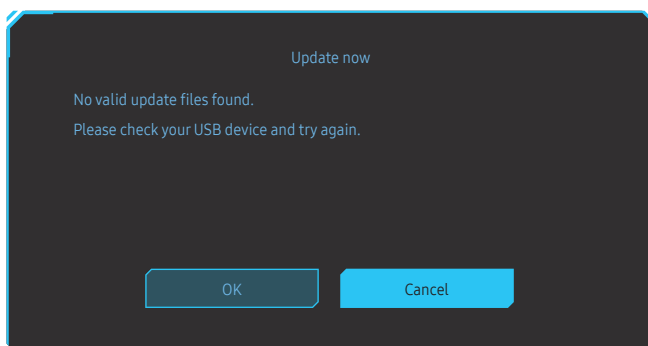

- No USB disk is inserted into the USB port.
  - The USB disk format is not supported.
  - The USB disk contains no valid upgrade files. (No upgrade files exist, or the file names are incorrect.)
- 5 Do not turn off the monitor. And prevent the upgrading from any interruption as far as possible. If an interruption happens, the monitor will return to the production version.
- Note that the production version may not be the same as the version before this upgrading if some other upgrading has been done earlier.

## Adjusting the Product Tilt and Height

The color and shape of parts may differ from what is shown. Specifications are subject to change without notice to improve quality.

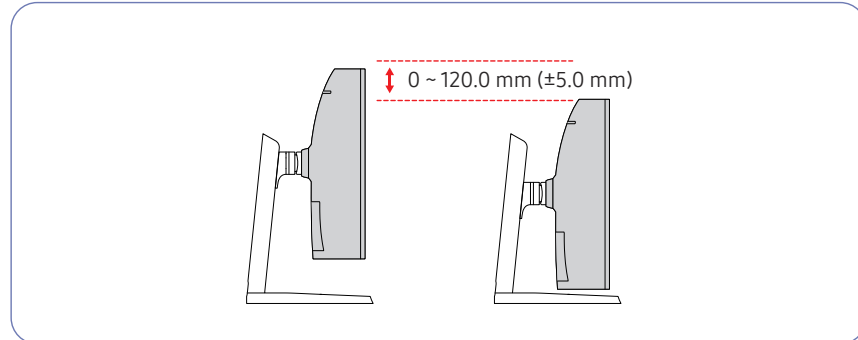
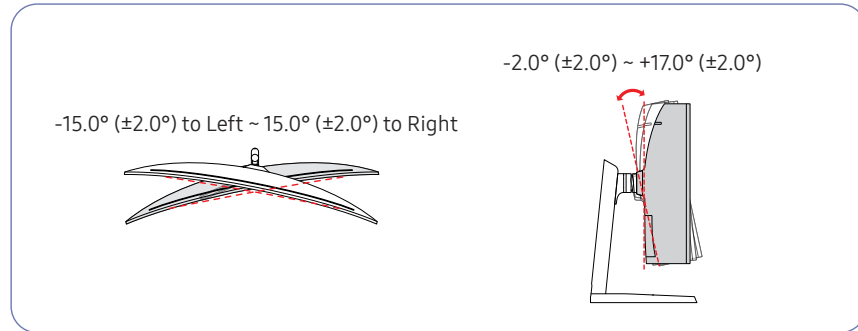

- The monitor tilt and height can be adjusted.
- When adjusting the tilt and height, hold both sides of the product and avoid using excessive force to prevent damage.
- When adjusting the stand height, you may hear a noise. This noise is generated because the ball inside the stand slides when the stand height is adjusted. It is a normal noise and not a product malfunction.

## Caution

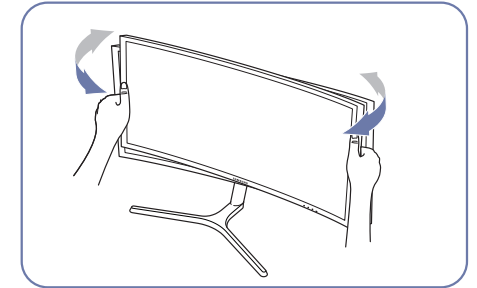
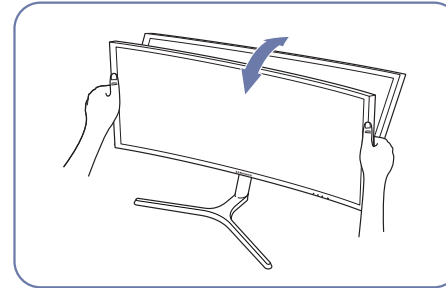

- Grasp the left and right sides of the monitor and adjust the tilt.

After adjusting the product tilt and height, if the screen is not level, take the following actions.

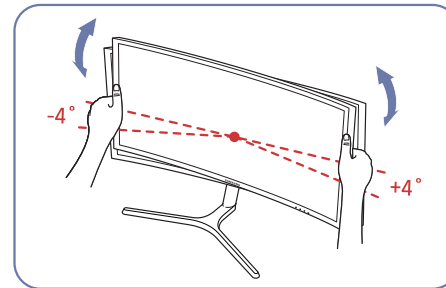

- Hold the bezel at both side edges and adjust the monitor angle until the screen becomes level. (Be careful not to directly hold the LCD display.)
- The monitor angle can be adjusted from -4° to +4°.



---

## Anti-theft Lock

- An anti-theft lock allows you to use the product securely even in public places.
- The locking device shape and locking method depend on the manufacturer. Refer to the user guide provided with your anti-theft locking device for details.

### To lock an anti-theft locking device:

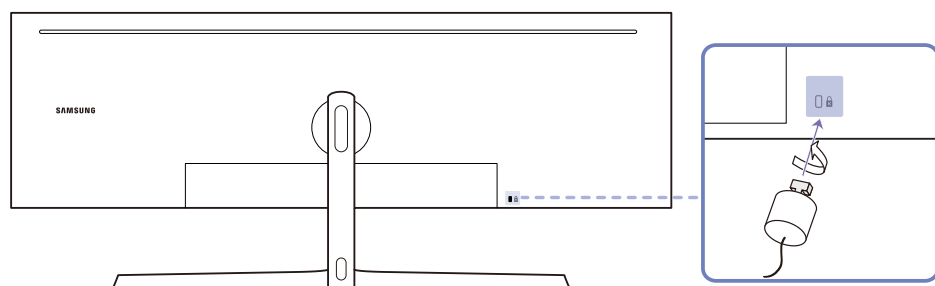

- 1 Fix the cable of your anti-theft locking device to a heavy object such as a desk.
- 2 Put one end of the cable through the loop on the other end.
- 3 Insert the locking device into the anti-theft lock slot at the back of the product.
- 4 Lock the locking device.
  - An anti-theft locking device can be purchased separately.
  - Refer to the user guide provided with your anti-theft locking device for details.
  - Anti-theft locking devices can be purchased at electronics retailers or online.

# Installation

## Attaching the Stand

Before assembling the product, place the product down on a flat and stable surface so that the screen is facing downwards.

**⚠** : The product is curved. Placing pressure on the product when on a flat surface may damage the product. When the product is on the ground facing up or down, do not put pressure on it.

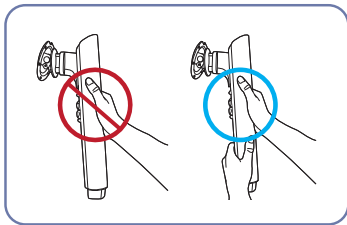

**Caution**  
Hold the stand neck with both hands, not one hand, to prevent it from falling off and causing injury.

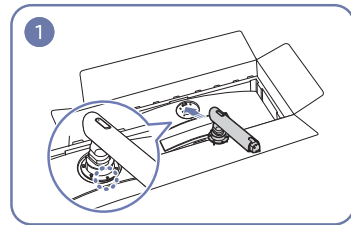

1 Place the stand neck on the monitor as shown in the figure.

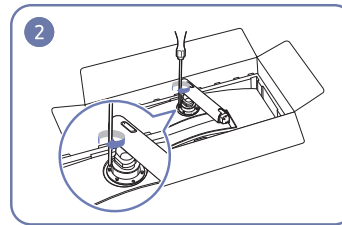

2 Fasten the screws at the top of the stand neck.

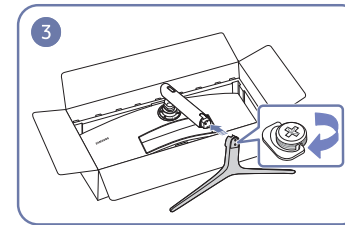

3 Insert the stand base into the stand neck in the direction as shown in the figure.

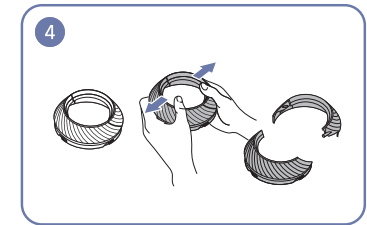

4 Disassemble the COVER-REAR TOP.

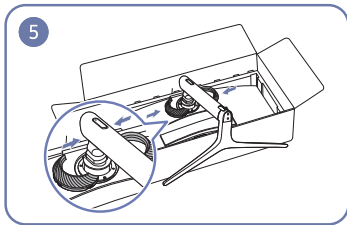

5 Assemble the COVER-REAR TOP to the stand neck as shown in the figure.

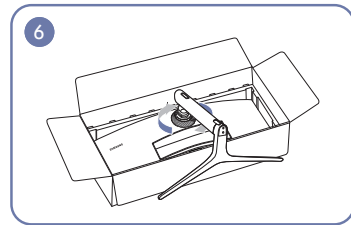

6 Rotate the COVER-REAR TOP clockwise.

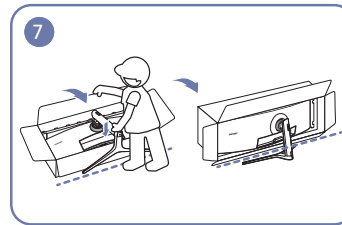

7 Stand up the monitor as shown in the figure.

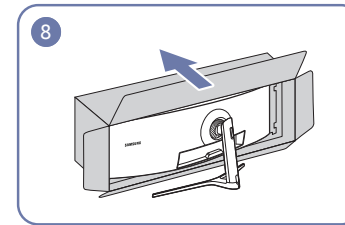

8 Remove the package.

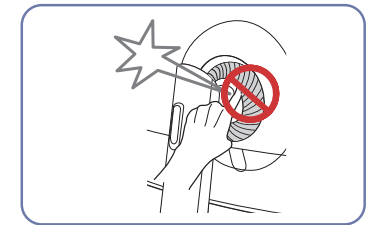

## Removing the Stand (For Attaching the BRACKET WALL)

— Before removing the stand from the monitor, place the monitor on a flat and stable surface with the screen facing down.

⚠ : The product is curved. Placing pressure on the product when on a flat surface may damage the product. When the product is on the ground facing up or down, do not put pressure on it.

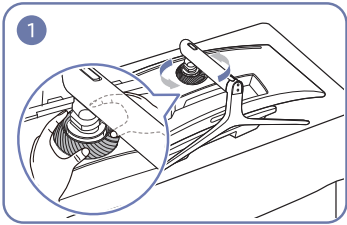

Rotate the COVER-REAR TOP counterclockwise.

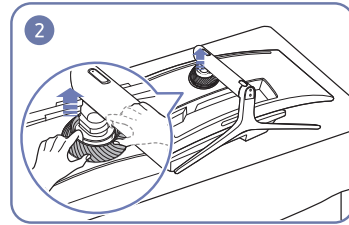

Lift the COVER-REAR TOP.

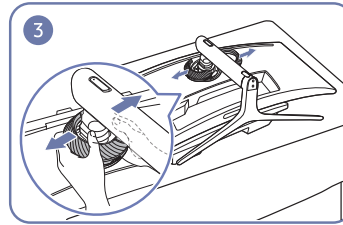

Disassemble the COVER-REAR TOP.

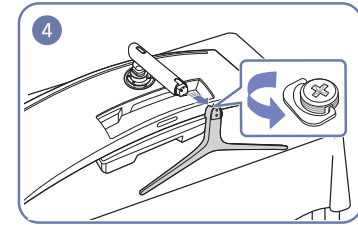

Remove the stand base from the stand neck.

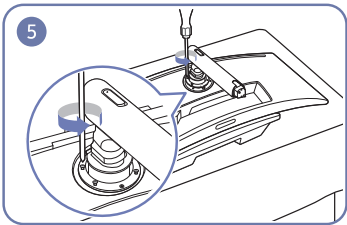

Unfasten the 4 screws at the top of the stand neck.

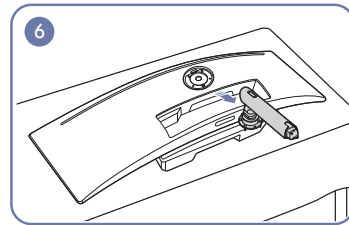

Lift and remove the stand.

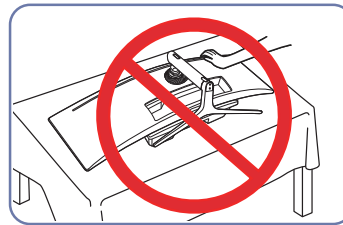

### Caution

Do not press down on the monitor. There is a risk of damaging the monitor.

## Attaching the BRACKET WALL

— Power the product off and remove the power cable from the power socket.

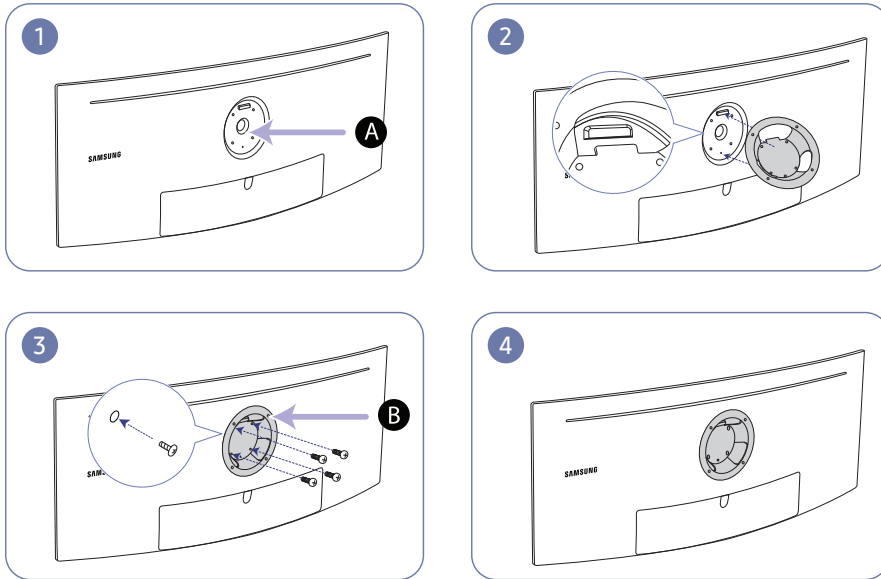

**A** Attach the BRACKET WALL here

**B** BRACKET WALL

Align **B** with **A** on the monitor, then tightly fasten with the screws removed from the stand ([P.19](#)).

### • Notes

- Using a screw longer than the standard length can damage the internal components of the product.
- The length of screws required for a wall mount that does not comply with the VESA standards may vary depending on the specifications.
- Do not use screws that do not comply with the VESA standards. Do not attach the wall-mount kit or desktop stand using excessive force. The product may get damaged or fall and cause personal injury. Samsung shall not be held liable for any damage or injury caused by using improper screws or attaching the wall-mount kit or desktop stand using excessive force.
- Samsung shall not be held liable for any product damage or personal injury caused by using a wall-mount kit other than the one specified or from an attempt to install the wall-mount kit on your own.
- To mount the product on a wall, ensure you purchase a wall-mount kit that can be installed 10 cm or farther away from the wall.
- Be sure to use a wall-mount kit that complies with the standards.
- To install the monitor using a wall mount, disconnect the stand base from the monitor.

Unit: mm

Model name	VESA screw hole specs in millimeters	Standard Screw	Quantity
C49RG90SS*	100.0 x 100.0	4.0 mm $\Phi$ , 0.7 pitch * 10.0 mm long	4 EA

— Do not attach the BRACKET WALL when the monitor is turned on. This may cause electric shock and might result in injury.

# Chapter 03

## Connecting and Using a Source Device

### Pre-connection Checkpoints

- Before connecting a source device, read the user manual provided with it.  
The number and locations of ports on source devices may differ from device to device.
- Do not connect the power cable before connecting all other cables.  
Ensure you connect a source device first before connecting the power cable.  
Connecting the power cable during connection may damage the product.
- Check the types of ports at the back of the product you want to connect.

### Connecting and Using a PC

- Select a connection method suitable for your PC.
- Connecting parts may differ in different products.
  - Provided ports may vary depending on the product.

#### Connection Using the HDMI Cable

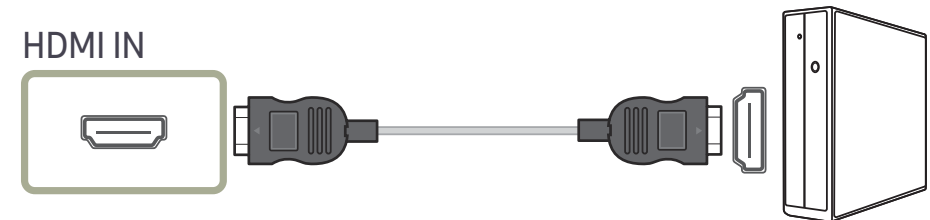

#### Connection Using the DP Cable

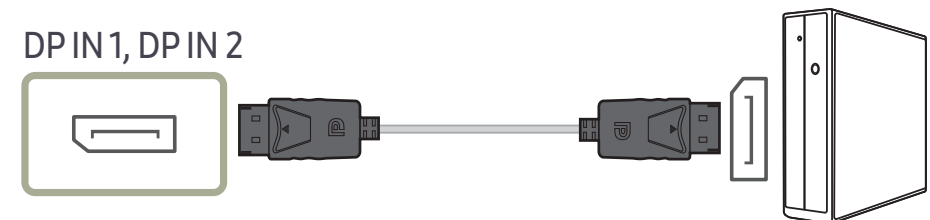

---

## Connecting to Headphones

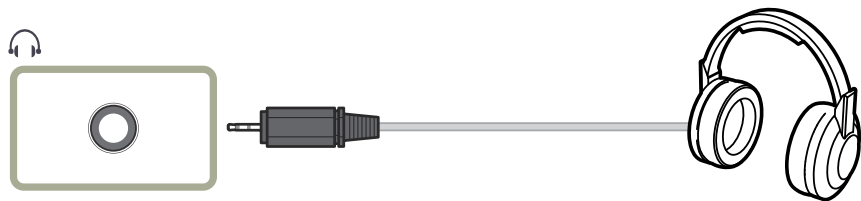

— Use headphones when activating sound with an HDMI-HDMI or DP cable.

---

## Connecting to Microphone

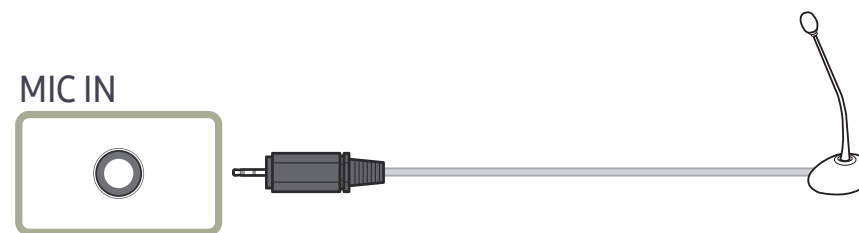

## Connection Using the Audio Cable

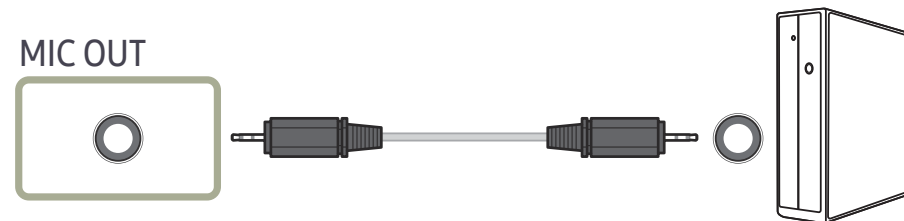



## Connecting the Product to a PC as a USB HUB

### Connecting a PC to the Product

The product can function as a HUB by connecting to a PC via a USB cable. You can connect a source device directly to the product and control the device from the product, without having to connect the device to the PC.

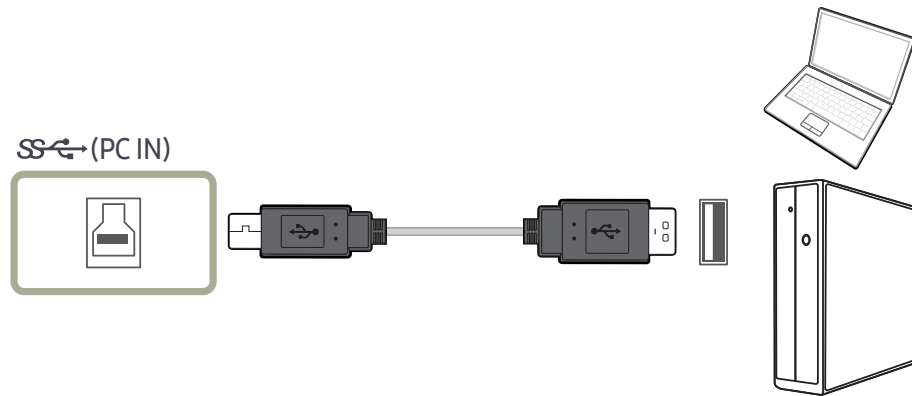
To use the product as a USB hub, connect the product to a PC using a USB cable.



Connect the USB cable to  on the back of the product and USB  on the PC.

A USB 2.0 cable can be used to connect the product to a PC. However, to take full advantage of the USB 3.0 function, connect a USB 3.0 cable between the PC and the product. Ensure the PC supports USB 3.0.

## Utilizing the Product as a USB HUB

Using the product as a hub, connect and use various source devices with the product at the same time.

A PC cannot connect to multiple source devices at the same time as it has a limited number of input/output ports available. The HUB feature on the product will improve your work efficiency by allowing you to connect multiple source devices to the USB ports on the product at the same time without connecting them to a PC.

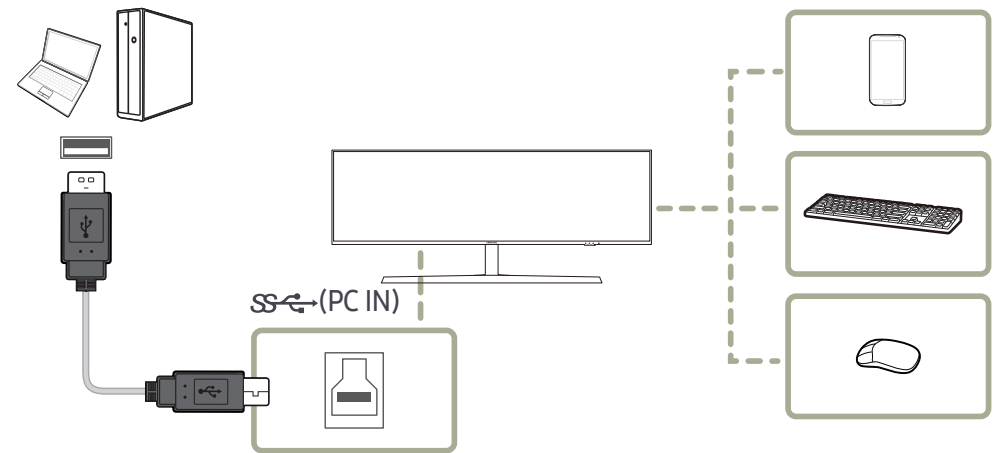

If multiple source devices are connected to the PC, the many cables around the PC may look messy. Connecting the devices directly to the product will resolve such inconvenience.

Connect a mobile device such as an MP3 player or smartphone to the product when connected to a PC. This allows you to control the device from the PC or charge the device battery.

- To detect and start a USB device faster, connect the device to the USB 3.0 port on the product. The read/write rate will be affected by the USB device and your PC.
- The product does not support media play. If you need to play a file in your USB device, please connect the product as a Hub to your PC and play the file on your PC.
- For USB-related problems caused by OS, drive programs or software, please contact relevant suppliers.
- With the launch of various USB devices on the market, we cannot guarantee that our products are matched with all USB devices.
- For an external mass-storage HDD requiring external power supply, be sure to connect it to a power source.
- The super charging can only be provided through port **SS-C/2**. According to the USB 3.0 battery charging specification, **SS-C/2** can support a maximum current of 1.5A. The actual current value depends on the device to be charged.  
If the current is too high or an exception occurs, the over-current protection will be triggered. This is a normal setting of the product.
- USB devices requiring high current may not be supported. **SS-C/1** can support a maximum current of 1.0A, and **SS-C/2** can support a maximum current of 1.5A.
- The battery can be charged in the power-saving mode, but it cannot be charged when the product is powered off.
- Charging your USB device is not possible if the power cable is disconnected from the power socket.
- The USB device needs to be purchased separately.

## Connecting a USB device



- You can use a USB device such as a mouse, keyboard, memory stick or external hard disk drive (HDD) by connecting it directly to the **SS-1/2** port on the monitor. You do not need to connect it to the computer.  
For an external mass-storage HDD requiring external power supply, be sure to connect it to a power source.

The **SS-1/2** USB port of the monitor supports High-Speed Certified USB 2.0.

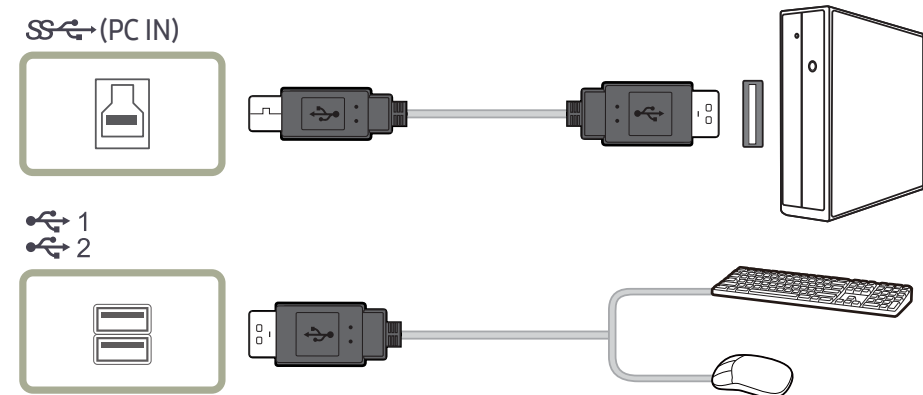
	High speed	Full speed	Low speed
Data Rate	480 Mbps	12 Mbps	1.5 Mbps
Power Consumption	2.5 W (Max., each port)	2.5 W (Max., each port)	2.5 W (Max., each port)





- 1 Connect the  port of the monitor and the USB port of the computer with the USB cable.
    - To use  $\frac{1}{2}$  port, you have to connect the UP (Upstream Cable) to the PC.
    - Make sure to use the USB cable supplied with this monitor to connect the monitor's  port and your computer's USB port.
  - 2 Use the USB cable to connect a USB device to the  $\frac{1}{2}$  port on the monitor.
  - 3 The use procedures are as the same as those for using an external device connecting to the PC.
    - You can connect and use a keyboard and mouse.
    - You can play a file from a media device. (Examples of media devices: MP3, digital camera, etc.)
    - You can run, move, copy or delete the files on the storage device. (Examples of storage devices: external memory, memory card, memory reader, HDD-type MP3 player, etc.)
    - You can use other USB devices that can be connected to a computer.
- When connecting a device to the  $\frac{1}{2}$  port of the monitor, connect the device using a cable appropriate to the device.
- For the purchase of the cable and external devices, ask the service center of the corresponding product.
- The company is not liable for problems or damages to an external device caused by using an unauthorized cable for the connection.
- Some products do not follow the USB standard, and it may cause a malfunction of the device.
- If the device malfunctions even if it is connected to the computer, contact the service center of the device/ computer.
- With the launch of various USB devices on the market, we cannot guarantee that our products are matched with all USB devices.

## Connecting the Power

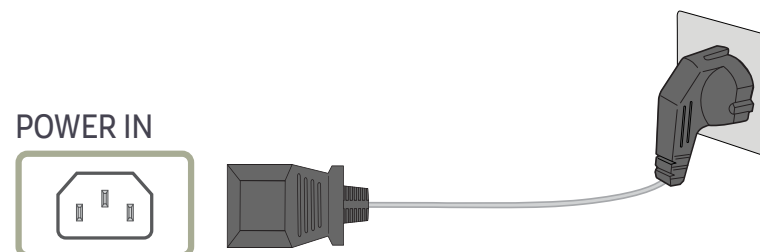

- To use the product, connect the power cable to a power outlet and the **POWER IN** port on the product.
- The input voltage is switched automatically.

## Tidying Up the Connected Cables

 : Headphones hanger

 : Downward

 : Upward

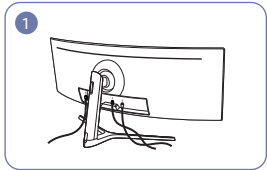

Connect the corresponding cables.

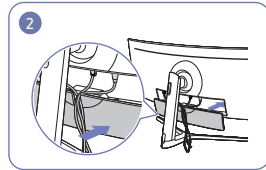

Arrange the cables against the bend tendency of the cables and pull the cables out of the COVER-REAR SUB grooves.

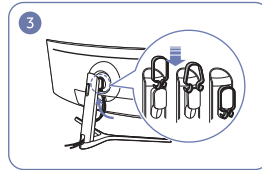

Hang the HOLDER-CABLE in the direction as shown in the figure.

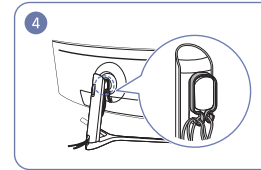

Arrange the cables against their bend tendency, and then pull them through the HOLDER-CABLE hangers. When the set height is changed, you need to arrange the cables and pull them through the HOLDER-CABLE hangers again.

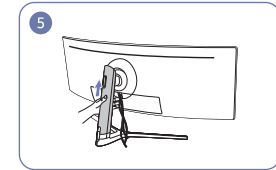

Push the COVER STAND BODY REAR in the direction as shown in the figure.

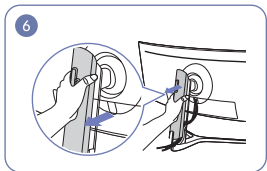

Remove the COVER STAND BODY REAR by pulling it in the direction as shown in the figure.

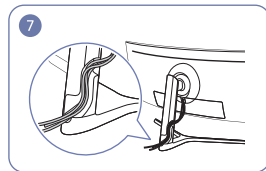

Place the corresponding cables into the stand-neck holder. Do not stretch the cable. Three cables in one holder is recommended.

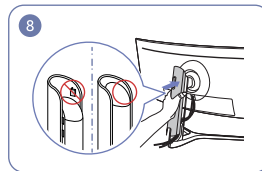

Attach the COVER STAND BODY REAR in the direction as shown in the figure with the buckles not being exposed.

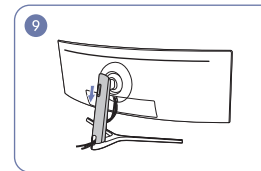

Move down the COVER STAND BODY REAR until it covers the stand neck completely.

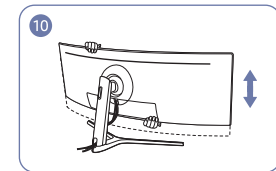

Adjust the set height, if required.

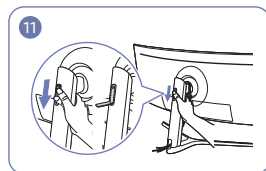
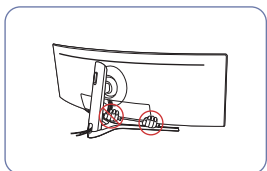

Open the Headset Hanger by pushing it down.

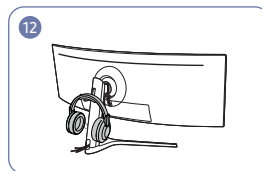

Hang the headset.

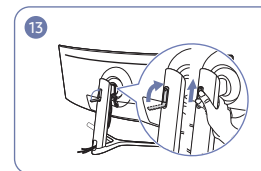

Rotate and then push up the Headset Hanger in the directions as shown in the figure.

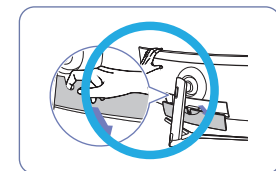

**Caution**  
Open the COVER-REAR SUB in the direction as shown in the figure.

---

## Correct posture to use the product



Use the product in the correct posture as follows:

- Allow a distance of 45 to 50cm between your eye and the screen, and look slightly downward at the screen.
- Keep your eyes directly in front of the screen.
- Straighten your back.
- Adjust the angle so light does not reflect on the screen.
- Keep your forearms perpendicular to your upper arms and level with the back of your hands.
- Keep your elbows at about a right angle.
- Adjust the height of the product so you can keep your knees bent at 90 degrees or more, your heels attached to the floor, and your arms lower than your heart.
- Do the Eye exercises or blink frequently, then eye fatigue will be relieved.

---

## Driver Installation

- You can set the optimum resolution and frequency for this product by installing the corresponding drivers.
- To install the latest version of the product driver, download it from the Samsung Electronics website at <http://www.samsung.com>.

## Setting Optimum Resolution

An information message about setting optimum resolution will appear if you power on the product for the first time after purchase.

Select a language on the product and change the resolution on your PC to the optimum setting.

- If the optimum resolution is not selected, the message will appear up to three times for a specified time even when the product is turned off and on again.
- The optimum resolution can also be selected in Control Panel on your PC.
- To change the refresh rate while retaining the current resolution, select **Game** → **Refresh Rate** on the OSD menu.

# Chapter 04

## Game

A detailed description of each function is provided. Refer to your product for details.

— The functions available may vary depending on the product model. The color and shape of parts may differ from what is shown. Specifications are subject to change without notice to improve quality.

### Picture Mode

This menu provides an optimum picture quality suitable for the environment where the product will be used.

- This menu is not available when **Eye Saver Mode** is enabled.
- This menu is not available when **PBP** is enabled.
- This **Dynamic Contrast** is not available when **Local Dimming** is activated.
- This menu is not available when **PC/AV Mode** is set to **AV** and **HDR** is activated.

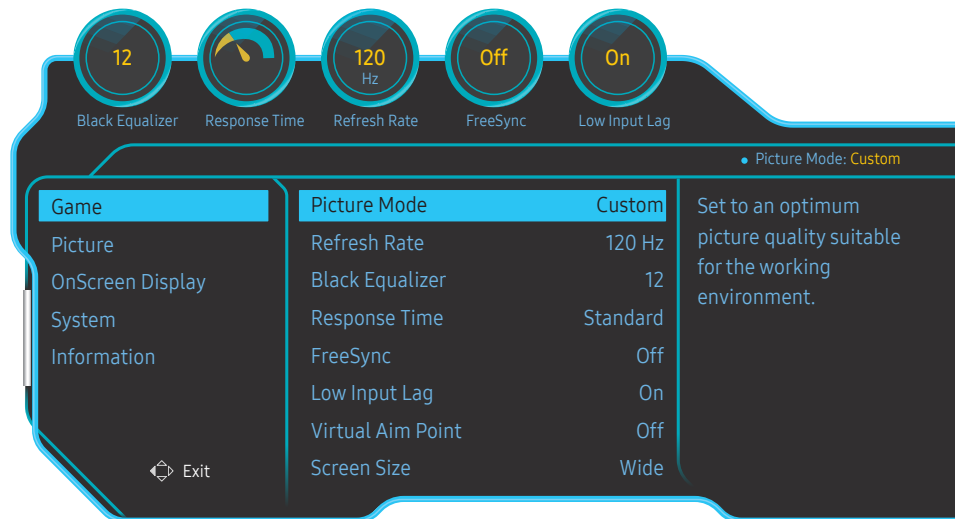

— The displayed image may differ depending on the model.

### In PC mode

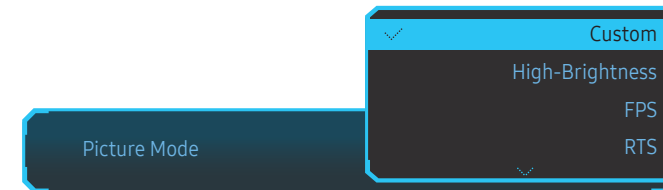

- **Custom**: Customize the screen settings.
- **High-Brightness**: Maximize the screen brightness.
- **FPS**: Increase the brightness of darker areas of the FPS game screen. This mode increases visibility of your enemies during an FPS game.
- **RTS**: Increase the color temperature and contrast ratio to improve visibility of the RTS screen and minimap.
- **RPG**: This mode is optimized for 3D graphics and instant messaging on the RPG game screen.
- **AOS**: Increase the contrast ratio to obtain a picture quality optimized for the AOS game screen.
- **sRGB**: Adjust the color system to **sRGB** mode. This is the standard mode of this monitor.
- **Cinema**: Obtain the brightness and sharpness of TVs suitable for enjoying video and DVD content.
- **Dynamic Contrast**: Obtain balanced brightness through automatic contrast adjustment.

## In AV mode

When the external input is connected through HDMI/DP and **PC/AV Mode** is set to **AV**, **Picture Mode** has four automatic picture settings (**Dynamic**, **Standard**, **Movie** and **Custom**) that are preset at the factory. You can activate either **Dynamic**, **Standard**, **Movie** or **Custom**. You can select **Custom** which automatically recalls your personalized picture settings.

- **Dynamic**: Select this mode to view a sharper image than in **Standard** mode.
- **Standard**: Select this mode when the surroundings are bright. This also provides a sharp image.
- **Movie**: Select this mode when the surroundings are dark. This will save power and reduce eye fatigue.
- **Custom**: Select this mode when you want to adjust the image according to your preferences.

## Refresh Rate

Change the screen refresh rate. A higher refresh rate can reduce eye strain.

- **60 Hz / 100 Hz / 120 Hz**

	Optimum resolution	
	HDMI	DisplayPort1/DisplayPort2
60 Hz	5120 x 1440 @ 60 Hz	5120 x 1440 @ 60 Hz
100 Hz	3840 x 1080 @ 100 Hz	5120 x 1440 @ 100 Hz
120 Hz	3840 x 1080 @ 120 Hz	5120 x 1440 @ 120 Hz

- Due to the bandwidth limitation of HDMI 2.0, the resolution of 5120 x 1440 can't be achieved when **Refresh Rate** is set to **100 Hz** or **120 Hz** in **HDMI** source.
- The resolution of 5120 x 1440 only support to connect to PC.
- Devices other than computers, if the actual resolution is abnormal when select **60 Hz** in **HDMI** source, please choose **100 Hz** or **120 Hz** again.
- To support the resolution of 5120 x 1440, you must update both your graphics card driver and windows OS to the latest version.
- This menu is not available when **FreeSync** is set to **Standard Engine** or **Ultimate Engine** mode.
- When changing the **Refresh Rate**, the screen may flicker depending on the computer graphics card.
- The function is available in a computer equipped with the graphic card that can change the refresh rate. It is unavailable in the devices (e.g. AV devices) with fixed refresh rates. If the function is applied, the screen may have malfunction.
- This menu is not available when **PBP** is enabled.
- This menu is not available when **HDMI Mode** is set to **1.4**.

---

## Black Equalizer

Adjust the brightness of the dark areas.

As the value gets closer to 1, the darker areas of the screen become brighter, making it easier to find enemies when playing a game. To find enemies more easily during a game, use a lower value.

As the value gets closer to 20, the darker areas of the screen become darker and the contrast increases.

— This menu is not available when **Picture Mode** is set to **Cinema** mode.

— This menu is not available when **Eye Saver Mode** is enabled.

— This menu is not available when **PBP** is enabled.

## Response Time

Increase the response rate of the video or game screen.

The **Faster** and **Fastest** modes display motion blur-free sharper pictures with faster movements by analyzing movement of liquid crystals in the panel and controlling the LED behavior.

— Use **Standard** mode when not playing a video or game.

— This menu is not available when **FreeSync** is set to **Standard Engine** or **Ultimate Engine** mode.

— This menu is not available when **PBP** is enabled.

---

## FreeSync

**FreeSync** technology is solution that eliminates screen tearing without all the usual lag and latency.

This feature will eliminate screen tearing and lag during game play. Improve your gaming experience.

The displayed **FreeSync** menu items on the monitor may vary, depending on the monitor model and compatibility with the AMD graphics card.

- **Off**: Disable **FreeSync**.
- **Standard Engine**: Enable the basic **FreeSync** functions of the AMD graphics card.
- **Ultimate Engine**: Enable the **FreeSync** feature with a higher screen frame rate. Screen tearing (abnormal sync between the screen and content) is reduced in this mode. Note that screen flickering may occur during game play.

Apply the optimum resolution when using **FreeSync**.

The refresh rate setting method please refer to Q & A → **How can I change the frequency?**

— The **FreeSync** function is only enabled in **DisplayPort1** or **DisplayPort2** mode.

Use the DP cable provided by the manufacturer when using **FreeSync**.

— This menu is not available when **PBP** is enabled.

If you use the **FreeSync** function while playing a game, the following symptoms may occur:

- The screen may flicker depending on the type of graphics card, the game option settings, or the video being played. Try the following actions: decrease the game setting values, change the current **FreeSync** mode to **Standard Engine**, or visit the AMD website to check your graphics driver's version and update it with the latest one.
- While you are using the **FreeSync** function, the screen may flicker due to variation of the output frequency from the graphics card.
- The response rate during the game may fluctuate depending on the resolution. A higher resolution generally decreases the response rate.
- The sound quality of the monitor may be degraded.

— If you encounter any issues when using the function, contact the Samsung Service Center.

— When the resolution is changed while setting **FreeSync** to **Standard Engine** or **Ultimate Engine**, the screen tearing can happen intermittently. Set **FreeSync** to **Off** and change the resolution.

— The function is unavailable in the devices (e.g. AV devices) that have no AMD graphic card. If the function is applied, the screen may have malfunction.

— For optimal screen images, **Brightness** may be adjusted in **FreeSync** mode depending on the input content.

## How do you enable FreeSync?

1 Set **FreeSync** to **Standard Engine** or **Ultimate Engine** in the OSD menu.

2 Enable **FreeSync** in AMD Radeon Settings:

Right-click the mouse → AMD Radeon Settings → Display

The "AMD FreeSync" feature should be set to "On". Select to "On" if not already enabled.

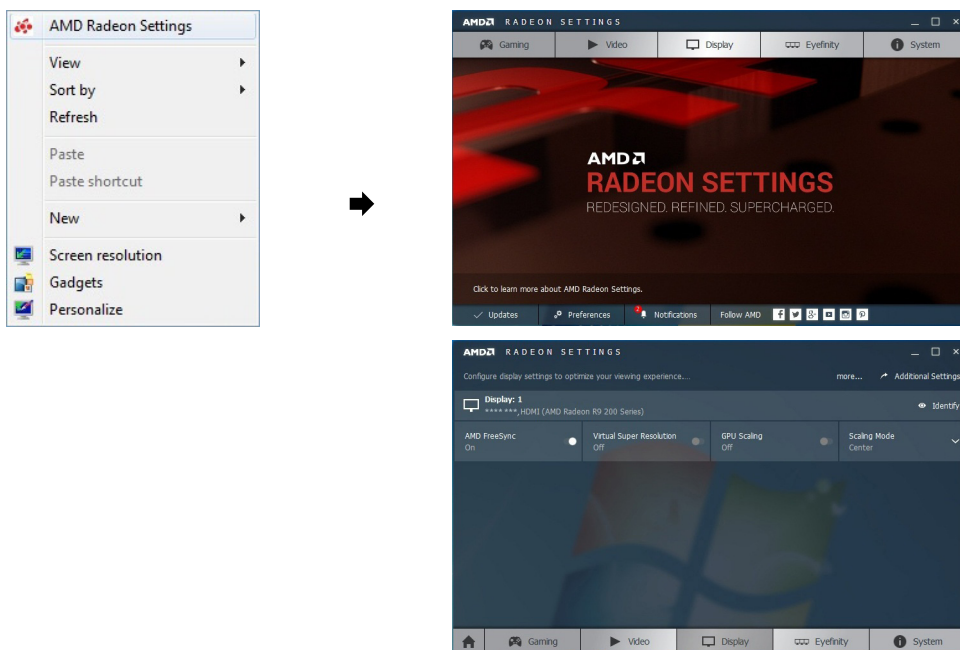

## The models in the Graphic Cards list supports FreeSync

**FreeSync** can only be used with specific AMD graphics card models. Refer to the following list for supported graphics cards:

Make sure to install the latest official graphics drivers from AMD that support **FreeSync**.

— For additional AMD graphics card models that support the **FreeSync** feature, visit the official AMD website.

— Select **FreeSync Off** if you are using a graphics card from a different manufacturer.

- AMD Radeon Vega series
- AMD Radeon RX 400 Series
- AMD Radeon RX 500 series

---

## Low Input Lag

Minimize input lag for fast reactions by reducing the video processing time.

- It is recommended to set the refresh rate of the graphic card to any of 100 Hz and 120 Hz. With 60 Hz, the function is unavailable.
- This feature is not available if the scanning rate on the computer is different from the settings in the **Refresh Rate** menu.
- This menu is not available when **PBP** is enabled.

## Virtual Aim Point

Show a virtual aim point on the center of the screen.

- Off: Virtual Aim Point** is not available while **Off** is selected.
  - : Select the preferred aim point style.
  - Reset Position**: Restore the aim point position to the default.
- This menu is not available when **PBP** is enabled.

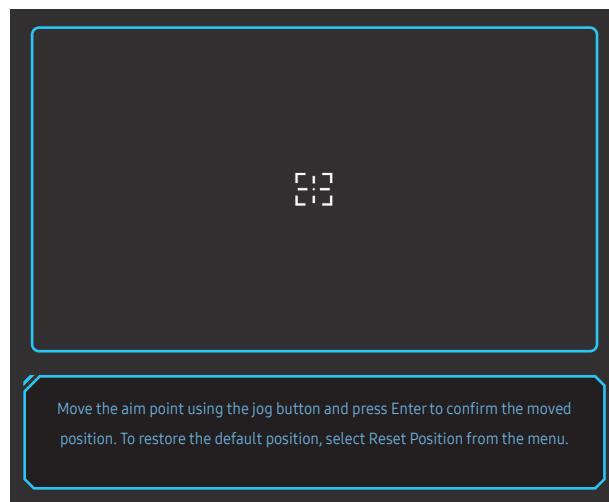

— The displayed image may differ depending on the model.

---

## Screen Size

Select the best screen size and ratio.

— This menu is not available when **PBP** is enabled.

### In PC mode

- Auto**: Display the picture according to the aspect ratio of the input source.
- Wide**: Display the picture in full screen regardless of the aspect ratio of the input source.
- 17" (4:3)**: Use a 4:3 aspect ratio on a 17-inch screen. Pictures with a different aspect ratio will not be displayed.
- 19" (4:3)**: Use a 4:3 aspect ratio on a 19-inch wide screen. Pictures with a different aspect ratio will not be displayed.
- 19" Wide (16:10)**: Use a 16:10 aspect ratio on a 19-inch wide screen. Pictures with a different aspect ratio will not be displayed.
- 21.5" Wide (16:9)**: Use a 16:9 aspect ratio on a 21.5-inch wide screen. Pictures with a different aspect ratio will not be displayed.
- 22" Wide (16:10)**: Use a 16:10 aspect ratio on a 22-inch wide screen. Pictures with a different aspect ratio will not be displayed.
- 23" Wide (16:9)**: Use a 16:9 aspect ratio on a 23-inch wide screen. Pictures with a different aspect ratio will not be displayed.
- 27" Wide (16:9)**: Use a 16:9 aspect ratio on a 27-inch wide screen. Pictures with a different aspect ratio will not be displayed.
- 29" Wide (21:9)**: Use a 21:9 aspect ratio on a 29-inch wide screen. Pictures with a different aspect ratio will not be displayed.



## In AV mode

- **4:3**: Display the picture with an aspect ratio of 4:3. Suitable for videos and standard broadcasts.
- **16:9**: Display the picture with an aspect ratio of 16:9.
- **21:9**: Display the picture with an aspect ratio of 21:9.
- **32:9**: Display the picture with an aspect ratio of 32:9.
- **Screen Fit**: Display the picture with the original aspect ratio without cutting off.
- **17" (4:3)**: Use a 4:3 aspect ratio on a 17-inch screen. Pictures with a different aspect ratio will not be displayed.
- **19" (4:3)**: Use a 4:3 aspect ratio on a 19-inch wide screen. Pictures with a different aspect ratio will not be displayed.
- **19" Wide (16:10)**: Use a 16:10 aspect ratio on a 19-inch wide screen. Pictures with a different aspect ratio will not be displayed.
- **21.5" Wide (16:9)**: Use a 16:9 aspect ratio on a 21.5-inch wide screen. Pictures with a different aspect ratio will not be displayed.
- **22" Wide (16:10)**: Use a 16:10 aspect ratio on a 22-inch wide screen. Pictures with a different aspect ratio will not be displayed.
- **23" Wide (16:9)**: Use a 16:9 aspect ratio on a 23-inch wide screen. Pictures with a different aspect ratio will not be displayed.
- **27" Wide (16:9)**: Use a 16:9 aspect ratio on a 27-inch wide screen. Pictures with a different aspect ratio will not be displayed.
- **29" Wide (21:9)**: Use a 21:9 aspect ratio on a 29-inch wide screen. Pictures with a different aspect ratio will not be displayed.

- The function may not be supported depending on the ports provided with the product.
- Changing the screen size is available when the following conditions are satisfied.
  - A digital output device is connected using the HDMI/DP cable.
  - The input signal is 480p, 576p, 720p, or 1080p and monitor can display normally (Not every model can support all of these signals.).
- This can only be set when the external input is connected through HDMI/DP and **PC/AV Mode** is set to **AV**. (**HDMI/DisplayPort1/DisplayPort2**: This option is available when **FreeSync** is disabled)

## Save Settings

Save up to three custom game modes to suit your preferences. Press a game mode shortcut key at the lower part of the monitor to directly access your favorite custom game mode.

— If you edit and save a custom game mode, the previous settings will be deleted. Be careful when editing a mode.

- **Game Setting 1 / Game Setting 2 / Game Setting 3 / Save / Cancel / Successfully saved.**

— This menu is not available when **PBP** is enabled.

## Game Setting Key

You can quickly view the setting with a shortcut key at the bottom without using an OSD menu. You can directly see the settings for three different modes.

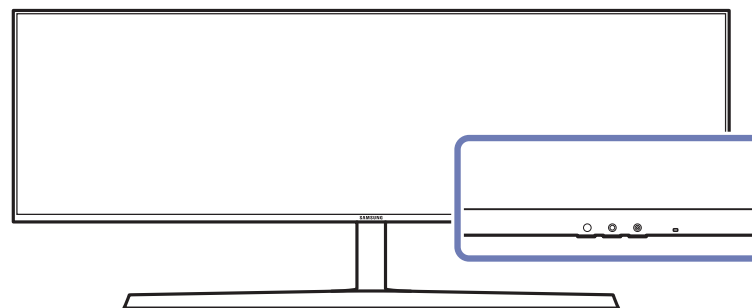

# Chapter 05

## Picture

A detailed description of each function is provided. Refer to your product for details.

— The functions available may vary depending on the product model. The color and shape of parts may differ from what is shown. Specifications are subject to change without notice to improve quality.

### Picture Mode

This menu provides an optimum picture quality suitable for the environment where the product will be used.

- This menu is not available when **Eye Saver Mode** is enabled.
- This menu is not available when **PBP** is enabled.
- This **Dynamic Contrast** is not available when **Local Dimming** is activated.
- This menu is not available when **PC/AV Mode** is set to **AV** and **HDR** is activated.

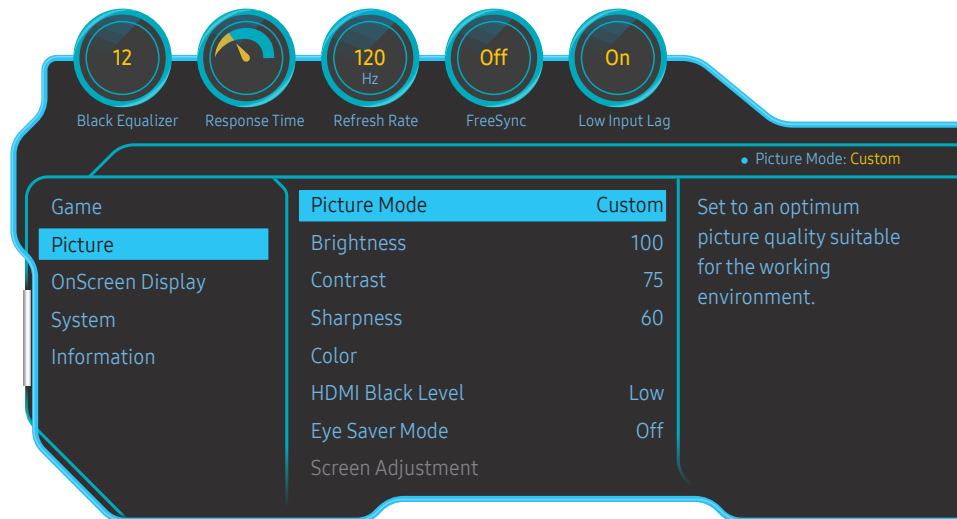

— The displayed image may differ depending on the model.

### In PC mode

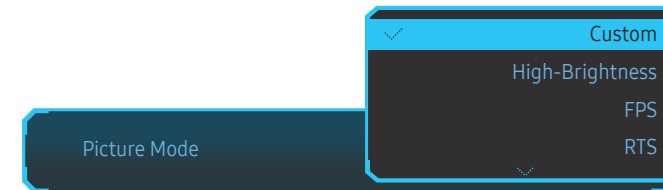

- **Custom:** Customize the screen settings.
- **High-Brightness:** Maximize the screen brightness.
- **FPS:** Increase the brightness of darker areas of the FPS game screen. This mode increases visibility of your enemies during an FPS game.
- **RTS:** Increase the color temperature and contrast ratio to improve visibility of the RTS screen and minimap.
- **RPG:** This mode is optimized for 3D graphics and instant messaging on the RPG game screen.
- **AOS:** Increase the contrast ratio to obtain a picture quality optimized for the AOS game screen.
- **sRGB:** Adjust the color system to **sRGB** mode. This is the standard mode of this monitor.
- **Cinema:** Obtain the brightness and sharpness of TVs suitable for enjoying video and DVD content.
- **Dynamic Contrast:** Obtain balanced brightness through automatic contrast adjustment.

---

## In AV mode

When the external input is connected through HDMI/DP and **PC/AV Mode** is set to **AV**, **Picture Mode** has four automatic picture settings (**Dynamic**, **Standard**, **Movie** and **Custom**) that are preset at the factory. You can activate either **Dynamic**, **Standard**, **Movie** or **Custom**. You can select **Custom** which automatically recalls your personalized picture settings.

- **Dynamic**: Select this mode to view a sharper image than in **Standard** mode.
- **Standard**: Select this mode when the surroundings are bright. This also provides a sharp image.
- **Movie**: Select this mode when the surroundings are dark. This will save power and reduce eye fatigue.
- **Custom**: Select this mode when you want to adjust the image according to your preferences.

---

## Brightness

You can adjust the general brightness of the picture. (Range: 0~100)

A higher value will make the picture appear brighter.

— This menu is not available when **Eye Saver Mode** is enabled.

— This menu is not available when **Picture Mode** is set to **Dynamic Contrast** mode.

## Contrast

Adjust the contrast between the objects and background. (Range: 0~100)

A higher value will increase the contrast to make the object appear clearer.

— This menu is not available when **Picture Mode** is set to **Cinema** or **Dynamic Contrast** mode.

## Sharpness

Make the outline of objects more clear or blurry. (Range: 0~100)

A higher value will make the outline of objects clearer.

— This menu is not available when **Picture Mode** is set to **Cinema** or **Dynamic Contrast** mode.

— This menu is not available when **PBP** is enabled.

---

## Color

Adjust the tint of the screen.

— This menu is not available when **Picture Mode** is set to **Cinema** or **Dynamic Contrast** mode.

— This menu is not available when **Eye Saver Mode** is enabled.

— This menu is not available when **PBP** is enabled.

- **Red**: Adjust the red saturation level. Values closer to 100 mean greater intensity for the color.
  - **Green**: Adjust the green saturation level. Values closer to 100 mean greater intensity for the color.
  - **Blue**: Adjust the blue saturation level. Values closer to 100 mean greater intensity for the color.
  - **Color Tone**: Select a color tone that best suits your viewing needs.
    - **Cool 2**: Set the color temperature to be cooler than **Cool 1**.
    - **Cool 1**: Set the color temperature to be cooler than **Normal** mode.
    - **Normal**: Display the standard color tone.
    - **Warm 1**: Set the color temperature to be warmer than **Normal** mode.
    - **Warm 2**: Set the color temperature to be warmer than **Warm 1**.
    - **Custom**: Customize the color tone.
- When the external input is connected through HDMI/DP and **PC/AV Mode** is set to **AV**, **Color Tone** has four color temperature settings (**Cool**, **Normal**, **Warm** and **Custom**).
- **Gamma**: Adjust the middle level of luminance.
    - **Mode1** / **Mode2** / **Mode3**

---

## HDMI Black Level

If a DVD player or set-top box is connected to the product via HDMI, image quality degradation (contrast/color degradation, black level, etc.) may occur, depending on the connected source device. In such case, **HDMI Black Level** can be used to adjust the image quality.

— This function is only available in **HDMI** mode.

- **Normal**: Select this mode when there is no contrast ratio degradation.
  - **Low**: Select this mode to reduce the black level and increase the white level when there is a contrast ratio degradation.
- **HDMI Black Level** may not be compatible with some source devices.
- The **HDMI Black Level** feature is only activated at a certain **AV** resolution, such as 720P and 1080P.
- This menu is not available when **PBP** is enabled.

## Eye Saver Mode

Set to an optimum picture quality suitable for eye relaxation.

TÜV Rheinland “Low Blue Light Content” is a certification for products which meet requirements for lower blue light levels. When **Eye Saver Mode** is ‘On’, the blue light that wavelength is around 400nm will decrease, and it will provide an optimum picture quality suitable for eye relaxation. At the same time, the blue light level is lower than in the default settings, and it was tested by TÜV Rheinland and certified as it met the requirements of TÜV Rheinland “Low Blue Light Content” standards.

---

## Screen Adjustment

- This option is only available when **PC/AV Mode** is set to **AV**.
- This menu is only available when **Screen Size** is set to **Screen Fit** in **AV** Mode.  
When a 480P or 576P or 720P or 1080P signal is input in **AV** mode and the monitor can display normally, select **Screen Fit** to adjust horizontal position in 0-6 levels.
- This menu is not available when **PBP** is enabled.

### Configuring H-Position & V-Position

**H-Position:** Move the screen to the left or right.

**V-Position:** Move the screen up or down.

## Calibration Report

The data from this report are measured in **Custom** mode at the time of shipment.

- The measurements may vary according to the measuring equipment, measuring location, system environment (e.g. computer, graphic board, etc) and other variables.
- Input signal: **HDMI**
- Each measurement from this report is based on the **Custom** mode at the time of shipment.
- This report is not provided on the menu of some products, but in an separate hardcopy report instead.

---

## PBP

Configuring the PBP Settings.

### PBP Mode

Enable or disable the **PBP Mode** function.

The PBP (Picture by Picture) function separates the screen into two parts displaying output from two different sources simultaneously on the left and right sides of the screen.

- **PBP** mode is compatible with Windows 7, Windows 8, and Windows 10.
- Make sure that the graphics card supports the PBP function. Visit the website of the graphics card manufacturer to check and update its driver to the latest version.
- The screen may flicker briefly or appear after a delay when you enable or disable the **PBP** function or when you change the screen size with the **PBP** function activated.  
This can typically arise when a PC and a monitor are connected to two or more input sources. It has nothing to do with the performance of a monitor.  
The issue is mainly caused when the video signals are delayed in transmission to the monitor depending on the graphics card performance.
- When the **PBP** function is enabled, the resolution will not be able to automatically switch to the optimum resolution due to a compatibility issue between the graphics card and the Windows system.  
Set **PBP Mode** to **Off**. Alternatively, restart the monitor, then set the resolution to the optimum setting using the Windows interface.

---

## Aspect Ratio

Select the image size for each screen.

- **16:9(16:9)**: Select this option if you want to use PBP mode where the optimum resolution for the left and right sides of the screen is 2560 x 1440 (width x height).
- **21:9(11:9)**: Select this option if you want to use PBP mode where the optimum resolution for the left side of the screen is 3360 x 1440 (width x height) and the optimum resolution for the right side of the screen is 1760 x 1440 (width x height).
- **11:9(21:9)**: Select this option if you want to use PBP mode where the optimum resolution for the left side of the screen is 1760 x 1440 (width x height) and the optimum resolution for the right side of the screen is 3360 x 1440 (width x height).

## Screen1

Select the input source you want to watch on screen1.

- **HDMI / DisplayPort1 / DisplayPort2**

## Screen2

Select the input source you want to watch on screen2.

- **HDMI / DisplayPort1 / DisplayPort2**

## Sound Source

Set which screen you want to hear the sound for.

- **Screen1 / Screen2**

# Chapter 06

## OnScreen Display

A detailed description of each function is provided. Refer to your product for details.

— The functions available may vary depending on the product model. The color and shape of parts may differ from what is shown. Specifications are subject to change without notice to improve quality.

### Language

Set the menu language.

- A change to the language setting will only be applied to the onscreen menu display.
- It will not be applied to other functions on your PC.

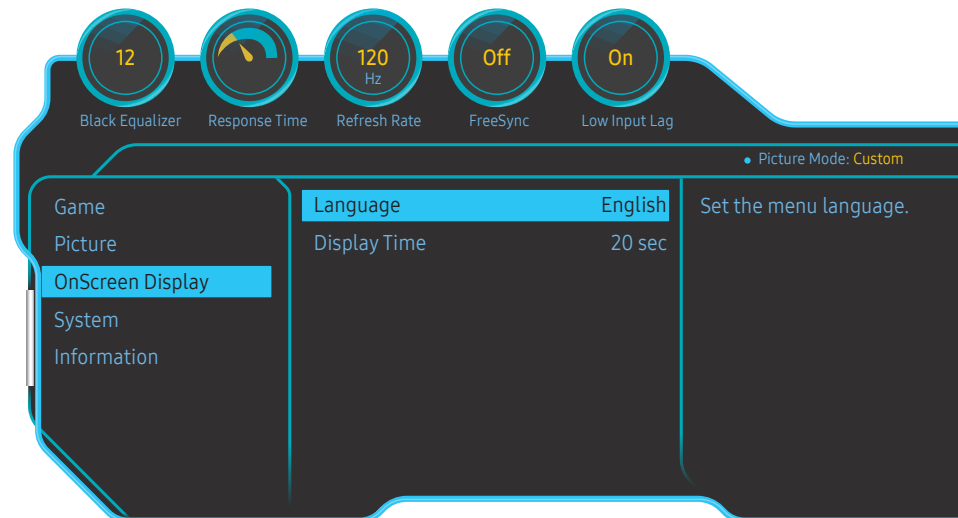

— The displayed image may differ depending on the model.

### Display Time

Set the on-screen display (OSD) menu to automatically disappear if the menu is not used for a specified period of time.

**Display Time** can be used to specify the time after which you want the OSD menu to disappear.

# Chapter 07

## System

A detailed description of each function is provided. Refer to your product for details.

— The functions available may vary depending on the product model. The color and shape of parts may differ from what is shown. Specifications are subject to change without notice to improve quality.

### Self Diagnosis

1 Use the function key and go to  → **System** → **Self Diagnosis**.

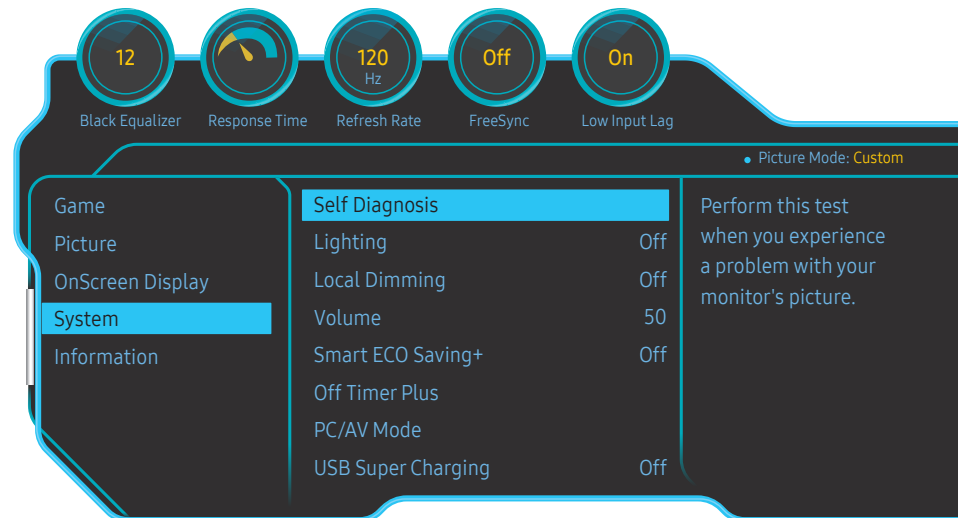

— The displayed image may differ depending on the model.

2 Select **OK** when the following screen is prompted.

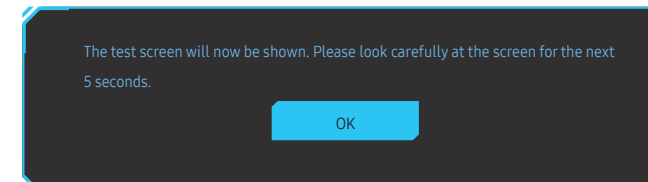

• Review the test screen.

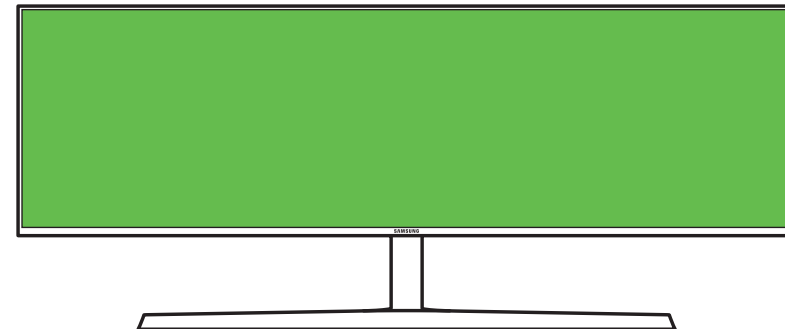



3 Base on the test result, select **Yes** / **No** / **Show Again**.

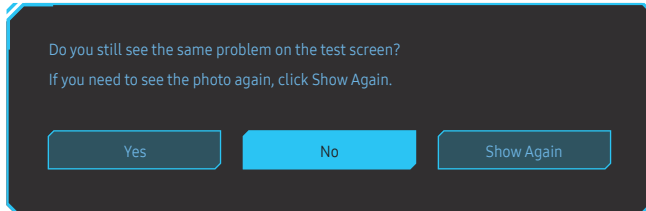

- You will see the following screen when you select **Yes**.

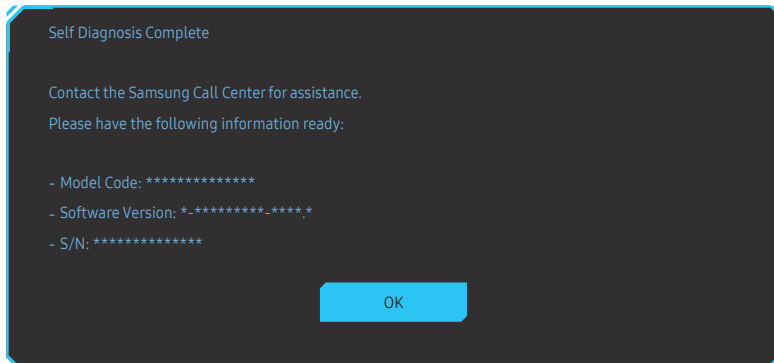

- You will see the following screen when you select **No**.

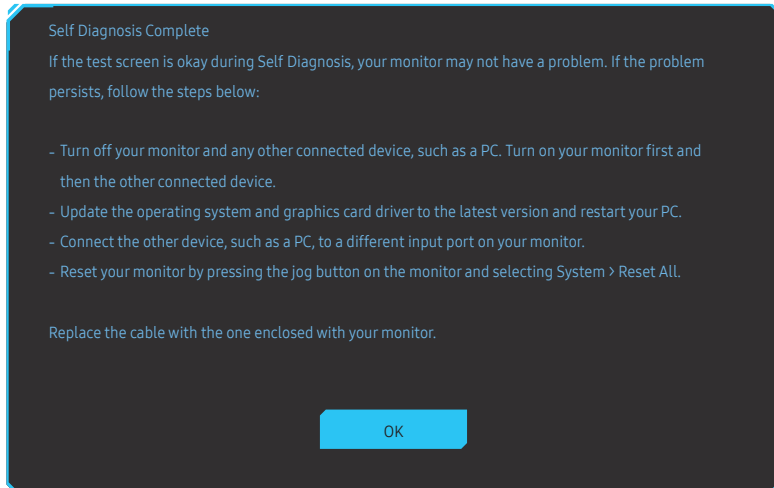

---

## Lighting

Configure how the LED lighting on the back of the screen works.

- **Off:** Deactivate the **Lighting** function.
- **On:** Activate the **Lighting** function.

## Local Dimming

Control the brightness of individual areas on the screen to maximise contrast automatically.

- **Off:** Deactivate the **Local Dimming** function.
- **Auto:** **Local Dimming** is automatically activated or deactivated based on whether the content is HDR.
  - When the Monitor detects that the input video contains HDR information, the Information menu and the Source menu will display HDR. In this case, Auto needs to be selected. (refer to [Information](#))
- **On:** Activate the **Local Dimming** function.
  - This menu is not available when **Eye Saver Mode** is enabled.
  - Use **Off** or **Auto** mode when not playing a video or game. Otherwise, screen flickering may occur.
  - This menu is not available when **PBP** is enabled.

## Volume

Adjust the **Volume** controlling the JOG button LEFT/RIGHT.

---

## Smart ECO Saving+

The **Smart ECO Saving+** function reduces power consumption by controlling the electric current used by the monitor panel.

- This menu is not available when **Eye Saver Mode** is enabled.
- This menu is not available when **Picture Mode** is set to **Dynamic Contrast** mode.
- This menu is not available when **PBP Mode** is enabled.
- This menu is not available when **Local Dimming** is activated.
- **Off:** Deactivate the **Smart ECO Saving+** function.
- **On:** The power consumption will be adjusted to save energy automatically. (The reduction of power consumption depends on the customer screen brightness condition.)

## Off Timer Plus

### Configuring Off Timer

**Off Timer:** Turn on **Off Timer** mode.

**Turn Off After:** The off timer can be set within a range of 1 to 23 hours. The product will automatically power off after the specified number of hours.

- This option is only available when **Off Timer** is set to **On**.
- For products for the market in some regions, the **Off Timer** is set to automatically activate 4 hours after the product powers on. This is done in accordance with power supply regulations. If you do not want the timer to activate, go to  → **System** → **Off Timer Plus** and set **Off Timer** to **Off**.

### Configuring Eco Timer

**Eco Timer:** Turn on **Eco Timer** mode.

**Eco Off After:** The **Eco Timer** can be set between 10 and 180 minutes. When the product is in power saving mode, it will automatically power off after the specified time has elapsed.

- This option is only available when **Eco Timer** is set to **On**.

---

## PC/AV Mode

Set **PC/AV Mode** to **AV**. The picture size will be enlarged.

This option is useful when you view a movie.

- Set to **PC** when connected to a PC.
- Set to **AV** when connected to an AV device.

— Supplied for the wide models only such as 16:9, 16:10, 21:9 or 32:9.

— If the monitor is in **HDMI**, **DisplayPort1**, **DisplayPort2** mode and the screen says **Check the cable connection and the settings of the source device**, or power saving mode activates, press the JOG button to display the function-button screen and then select the  icon. You can select **PC** or **AV**.

— This menu is not available when **PBP** is enabled.

---

## USB Super Charging

Charge the battery of a connected source device quickly using the **SS-C/2** port on the product.

- **Off**: Disable **USB Super Charging**.
- **On**: Enable the function to quickly charge a source device connected to the **SS-C/2** port.

— Super charging is available via the **SS-C/2** port. The charging speed may vary, depending on the connected device.

— Quick battery charging may not be supported and/or charging may take more time on some mobile devices.

— When super charging is turned off for the **SS-C/2** port, use this port for regular speed charging and data transfer.

— If a USB 2.0 or lower device is connected to the **SS-C/2** port and super charging is turned on, data transfer is impossible, but it is possible if a USB 3.0 device is connected.

※ These ports may not be compatible with new USB devices that may be released in the future.

— If a device, such as a mouse, keyboard or memory storage device, is connected to the **SS-C/2** port and the device is USB 2.0 or lower, turn off super charging.

— If super charging is turned on using the OSD settings menu, all devices connected to USB ports 1 through 2 on the monitor are re-recognized. This ensures optimum charging.

※ Before turning on super charging, close all files on storage devices connected to USB ports.

---

## DisplayPort Ver.

Select your DisplayPort version.

- Incorrect settings may cause the screen to go blank. If this occurs, check the device specifications.
- If the monitor (when set to **HDMI**, **DisplayPort1** or **DisplayPort2**) is in power saving mode or is displaying the message **Check the cable connection and the settings of the source device.** or power saving mode activates, press the JOG button to display the function-button screen and then select the  button to display the On Screen Display (OSD). You can select **1.1**, **1.2** or **1.4**.
- If setting the **DisplayPort Ver.** to **1.1**, for the bandwidth limitation of the DisplayPort 1.1 protocol, the actual maximum output refreshing rate of the display cards cannot achieve the level of 120 Hz.
- If you select **1.4**, the monitor can support up to 5120 x 1440 @ 120 Hz.
- If you use 5120 x 1440 in DisplayPort source, you can't select **1.2**.

---

## HDMI Mode

Select the HDMI mode to use.

- The supportable device and resolution may differ depending on its version.
- When the version is changed, the screen may blink.
- Some high resolutions may not be supported due to the bandwidth limit in HDMI **1.4** protocol while **HDMI Mode** is set to **1.4** or **2.0**.
- When the setting is not appropriate, a blank screen may appear. In this case, check the specifications of the device.
- Set **HDMI Mode** to **1.4** or **2.0** if sound from the connected DVD player is missing.
- This menu is not available when **PBP** is enabled.

## Source Detection

Select either **Auto** or **Manual** as the method to recognize input signal.

## Key Repeat Time

Control the response rate of a button when the button is pressed.

**Acceleration**, **1 sec**, or **2 sec** can be selected. If **No Repeat** is selected, a command responds only once when a button is pressed.

## Power LED On

Configure the settings to enable or disable the power LED located at the lower part of the product.

- **Working:** The power LED is on when the product is turned on.
- **Stand-by:** The power LED is on when the product is turned off.

## Reset All

Return all the settings for the product to the default factory settings.

— **Game Setting 1**, **Game Setting 2**, and **Game Setting 3** saved under **Save Settings** will not be changed.

## Information

View the current input source, frequency and resolution.

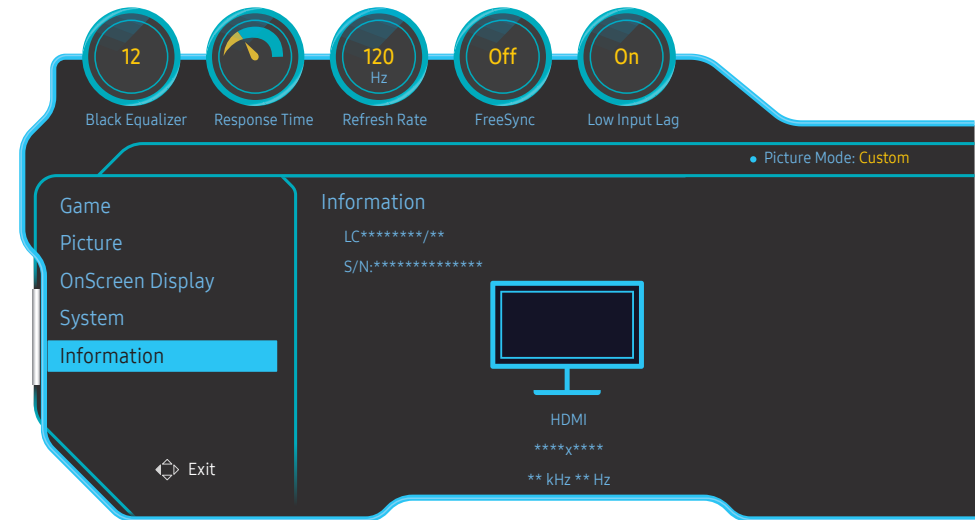

— The displayed image may differ depending on the model.

## HDR

Automatically provide an optimal HDR effect based on the video source.

If an HDR signal has been processed by some devices (graphics card/player, etc.), the signal will not output any HDR metadata and thus will not be recognized as an HDR signal. In this case, **Local Dimming** needs to be enabled manually so as to ensure optimal HDR effects.

The HDR (High Dynamic Range) technology implements video images that are very similar to the images seen through human eyes by finely adjusting the contrast of the source.

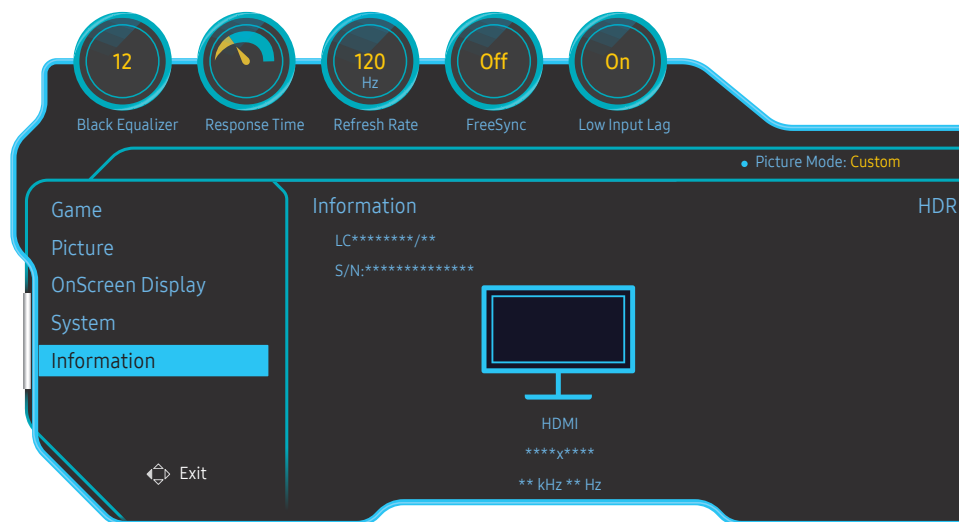

— The displayed image may differ depending on the model.

## Pre-requisite to the use of HDR:

- 1 Using a HDR-supported graphics card in combination with a HDR-supported game and connecting to the HDMI/DP port of this product can enable the HDR effect.
  - For information about whether the graphics card and game support HDR, visit their manufacturer's websites. Sometimes, the latest versions of the graphics card driver or game updates need to be installed to enable the HDR effect.
- 2 When a Blu-Ray DVD that supports HDMI 2.0a plays a UHD Blu-Ray disc with the UHDA (or HDR) logo, the HDR effect can be enabled.
- 3 When the Xbox One S plays a Microsoft Xbox HDR game or a UHD Blu-Ray disc with the UHDA (or HDR) logo, the HDR effect can be enabled.
- 4 When PS4/PS4 Pro plays a Sony PS HDR game, the HDR effect can be enabled.
- 5 Sometimes, your desktop may appear dimmer than usual when using windows 10, it's because the Windows automatically enable the Windows HD Color(HDR) mode. You can adjust the Windows HD Color setting in Windows to make it more suitable, or close this function if you're using SDR content.
  - For information about the Xbox One S/PS4 (Pro) games that support HDR, visit the official Xbox/PS4 websites.

\* When the HDR is enabled automatically, some functions such as **Color/Eye Saver Mode** are disabled automatically.

\* To enable the HDR effect for the HDMI port, you need to set **HDMI Mode** to **2.0** in the OSD menu.

\* To enable the HDR effect for the DP port, you need to set **DisplayPort Ver.** to **1.4** on the OSD menu and enable 10-bit color output in the graphics card settings.

\* This function is not available when **PBP** is enabled.

# Chapter 08

## Installing the Software

### Easy Setting Box



Easy Setting Box enables users to use the monitor by partitioning multiple sections.

To install the latest version of Easy Setting Box, download it from the Samsung Electronics website at <http://www.samsung.com>.

- The software may not work properly if you do not restart the computer after the installation.
- The Easy Setting Box icon may not appear depending on the computer system and the product specifications.
- If the shortcut icon does not appear, press the F5 key.

### Restrictions and Problems with the Installation

The Easy Setting Box installation may be affected by the Graphics Card, Motherboard and the Networking Environment.

### System Requirements

OS	Hardware
<ul style="list-style-type: none"><li>• Windows 7 32Bit/64Bit</li><li>• Windows 8 32Bit/64Bit</li><li>• Windows 8.1 32Bit/64Bit</li><li>• Windows 10 32Bit/64Bit</li></ul>	<ul style="list-style-type: none"><li>• At least 32MB of memory</li><li>• At least 60MB of free space on the hard disk drive</li></ul>

# Chapter 09

## Troubleshooting Guide

### Requirements Before Contacting Samsung Customer Service Center

— Before calling Samsung Customer Service Center, test your product as follows. If the problem persists, contact Samsung Customer Service Center.

### Testing the Product

Check if your product is operating normally by using the product test function.

If the screen is turned off and the power indicator blinks even though the product is properly connected to a PC, perform a self-diagnosis test.

- 1 Power off both the PC and product.
- 2 Disconnect the cables from the product.
- 3 Power on the product.
- 4 If the message **Check the cable connection and the settings of the source device.** appears, the product is working normally.

— If the screen remains blank, check the PC system, video controller and cable.

### Checking the Resolution and Frequency

For a mode that exceeds the supported resolution(refer to [Standard Signal Mode Table](#)), the message **Not Optimum Mode** will appear for a short time.

— The displayed resolution may vary, depending on the computer system settings and cables.

Check the following.

#### Installation issue (PC mode)

---

The screen keeps switching on and off.

Check the cable connection between the product and PC, and ensure the connectors are locked.

---

Blank spaces are found on all four sides of the screen when an HDMI or HDMI-DVI cable is connected to the product and PC.

The blank spaces found on the screen have nothing to do with the product.

Blank spaces on the screen are caused by the PC or graphics card. To resolve the problem, adjust the screen size in the HDMI or DVI settings for the graphics card.

If the graphics card settings menu does not have an option to adjust the screen size, update the graphics card driver to the latest version.

(Please contact the graphics card or computer manufacturer for further details about how to adjust the screen settings.)

---

#### Screen issue

---

The power LED is off. The screen will not switch on.

Check that the power cable is connected properly.

---

The message **Check the cable connection and the settings of the source device.** appears.

Check that the cable is properly connected to the product.

Check that the device connected to the product is powered on.

---



---

**Not Optimum Mode** is displayed.

This message appears when the signal from the graphics card exceeds the maximum resolution or frequency for the product.

Change the maximum resolution and frequency to suit the product performance, referring to Standard Signal Mode Table (P.52).

---

**The images on the screen look distorted.**

Check the cable connection to the product.

---

**The screen is not clear. The screen is blurry.**

Remove any accessories (video extension cable, etc.) and try again.

Set the resolution and frequency to the recommended level.

---

**The screen appears unstable and shaky. There are shadows or ghost images left on the screen.**

Check that the resolution and frequency for the PC are within the range of resolution and frequency compatible with the product. Next, if required, change the settings, referring to Standard Signal Mode Table (P.52) in this manual and the **Information** menu on the product.

---

**The screen is too bright. The screen is too dark.**

Adjust **Brightness** and **Contrast**.

---

**Screen color is inconsistent.**

Change the **Color** settings.

---

**The colors on the screen have a shadow and are distorted.**

Change the **Color** settings.

---

**White does not really look white.**

Change the **Color** settings.

---

**There is no image on the screen and the power LED blinks every 0.5 to 1 second.**

The product is operating in power-saving mode.

Press any key on the keyboard or move the mouse to return to normal operating mode.

---

**Text is blurry.**

If using a Windows OS (e.g. Windows 7, Windows 8, Windows 8.1 or Windows 10): Go to **Control Panel** → **Fonts** → **Adjust ClearType text** and change **Turn on ClearType**.

---

**Video playback is choppy.**

Playback of high-definition large video files can be choppy. This may be because the video player is not optimized for the computer resource.

Try playing the file on another video player.

---

---

**Sound issue**

---

**There is no sound.**

Check the connection of the audio cable or adjust the volume.

Check the volume.

---

**The volume is too low.**

Adjust the volume.

If the volume is still low after turning it up to the maximum level, adjust the volume on your PC sound card or software program.

---

**Video is available but there is no sound.**

Sound cannot be heard if an HDMI-DVI cable is used to connect the input device.

Connect the device using an HDMI cable or DP cable.

---

---

**Source device issue**

---

**A beeping sound is heard when my PC is booting.**

If a beeping sound is heard when your PC is booting, have your PC serviced.

---

---

## Q & A

— Refer to the user manual for your PC or graphics card for further instructions on adjustment.

---

### How can I change the frequency?

Set the frequency on your graphics card.

- Windows 7: Go to **Control Panel** → **Appearance and Personalization** → **Display** → **Screen Resolution** → **Advanced settings** → **Monitor**, and adjust **Refresh rate** under **Monitor settings**.
- Windows 8(Windows 8.1): Go to **Settings** → **Control Panel** → **Appearance and Personalization** → **Display** → **Screen Resolution** → **Advanced settings** → **Monitor**, and adjust **Refresh rate** under **Monitor settings**.
- Windows 10(Early version): Go to **Settings** → **System** → **Display** → **Advanced display settings** → **Display adapter properties** → **Monitor**, and adjust **Screen refresh rate** under **Monitor settings**.
- Windows 10(Version 1703 and later): Go to **Settings** → **System** → **Display** → **Display adapter properties** → **Monitor**, and adjust **Screen refresh rate** under **Monitor settings**.

---

### How can I change the resolution?

- Windows 7: Go to **Control Panel** → **Appearance and Personalization** → **Display** → **Adjust Resolution**, and adjust the resolution.
- Windows 8(Windows 8.1): Go to **Settings** → **Control Panel** → **Appearance and Personalization** → **Display** → **Adjust Resolution**, and adjust the resolution.
- Windows 10(Early version): Go to **Settings** → **System** → **Display** → **Advanced display settings**, and adjust the resolution.
- Windows 10(Version 1703 and later): Go to **Settings** → **System** → **Display**, and adjust the resolution.

---

### How do I set power-saving mode?

- Windows 7: Set power-saving mode in **Control Panel** → **Appearance and Personalization** → **Personalize** → **Screen Saver Settings** → **Power options** or **BIOS SETUP** on the PC.
  - Windows 8(Windows 8.1): Set power-saving mode in **Settings** → **Control Panel** → **Appearance and Personalization** → **Personalize** → **Screen Saver Settings** → **Power options** or **BIOS SETUP** on the PC.
  - Windows 10(Early version): Set power-saving mode in **Settings** → **Personalization** → **Lock screen** → **Screen timeout settings** → **Power & sleep** or **BIOS SETUP** on the PC.
  - Windows 10(Version 1703 and later): Go to **Settings** → **Power & sleep**, and make the setup.
-

# Chapter 10

## Specifications

### General

Model Name	C49RG90SS*
Size	123.9 cm
Display area	1193.472 mm (H) x 335.664 mm (V)
Pixel Pitch	0.2331 mm (H) x 0.2331 mm (V)
Maximum Pixel Clock	970 MHz
Power Supply	AC100-240V~ 50/60Hz Refer to the label at the back of the product as the standard voltage can vary in different countries.
Signal connectors	HDMI, DisplayPort
Environmental conditions	<b>Operating</b> Temperature: 10 °C – 40 °C (50 °F – 104 °F) Humidity: 10 % – 80 %, non-condensing <b>Storage</b> Temperature: -20 °C – 45 °C (-4 °F – 113 °F) Humidity: 5 % – 95 %, non-condensing

- Plug-and-Play  
This monitor can be installed and used with any Plug-and-Play compatible systems. Two-way data exchange between the monitor and PC system optimizes the monitor settings. Monitor installation takes place automatically. However, you can customize the installation settings if desired.
- Panel Dots (Pixels)  
Due to the nature of the manufacturing of this product, approximately 1 pixel per million (1ppm) may be brighter or darker on the LCD panel. This does not affect product performance.
- The above specifications are subject to change without notice to improve quality.
- This device is a Class B digital apparatus.
- For detailed device specifications, visit the Samsung Electronics website.

## Standard Signal Mode Table

Synchronization	Horizontal Frequency	30 – 190 kHz
	Vertical Frequency	24 – 120 Hz
Resolution	Optimum resolution	5120 x 1440 @ 60 Hz (HDMI) 5120 x 1440 @ 120 Hz (DisplayPort)
	Maximum resolution	5120 x 1440 @ 60 Hz (HDMI) 5120 x 1440 @ 120 Hz (DisplayPort)

If a signal that belongs to the following standard signal modes is transmitted from your PC, the screen will automatically be adjusted. If the signal transmitted from the PC does not belong to the standard signal modes, the screen may be blank even though the power LED turns on. In such a case, change the settings according to the following table by referring to the graphics card user manual.

### HDMI

Resolution	Horizontal Frequency (kHz)	Vertical Frequency (Hz)	Pixel Clock (MHz)	Sync Polarity (H/V)
IBM, 720 x 400	31.469	70.087	28.322	-/+
MAC, 640 x 480	35.000	66.667	30.240	-/-
MAC, 832 x 624	49.726	74.551	57.284	-/-
MAC, 1152 x 870	68.681	75.062	100.000	-/-
VESA DMT, 640 x 480	31.469	59.940	25.175	-/-
VESA DMT, 640 x 480	37.861	72.809	31.500	-/-
VESA DMT, 640 x 480	37.500	75.000	31.500	-/-
VESA DMT, 800 x 600	35.156	56.250	36.000	+/+
VESA DMT, 800 x 600	37.879	60.317	40.000	+/+
VESA DMT, 800 x 600	48.077	72.188	50.000	+/+
VESA DMT, 800 x 600	46.875	75.000	49.500	+/+
VESA DMT, 1024 x 768	48.363	60.004	65.000	-/-
VESA DMT, 1024 x 768	56.476	70.069	75.000	-/-
VESA DMT, 1024 x 768	60.023	75.029	78.750	+/+
VESA DMT, 1152 x 864	67.500	75.000	108.000	+/+
VESA DMT, 1280 x 720	45.000	60.000	74.250	+/+

## HDMI

Resolution	Horizontal Frequency (kHz)	Vertical Frequency (Hz)	Pixel Clock (MHz)	Sync Polarity (H/V)
VESA DMT, 1280 x 800	49.702	59.810	83.500	-/+
VESA DMT, 1280 x 1024	63.981	60.020	108.000	+/+
VESA DMT, 1280 x 1024	79.976	75.025	135.000	+/+
VESA DMT, 1440 x 900	55.935	59.887	106.500	-/+
VESA DMT, 1600 x 900	60.000	60.000	108.000	+/+
VESA DMT, 1680 x 1050	65.290	59.954	146.250	-/+
VESA DMT, 1920 x 1080	67.500	60.000	148.500	+/+
CEA, 1920 x 1080	112.500	100.000	297.000	+/+
CEA, 1920 x 1080	135.000	120.000	297.000	+/+
CEA, 2560 x 1080	66.000	60.000	198.000	+/+
CEA, 2560 x 1080	125.000	100.000	371.250	+/+
CEA, 2560 x 1080	150.000	120.000	495.000	+/+
VESA CVT, 2560 x 1440	88.787	59.951	241.500	+/-
VESA CVT, 3840 x 1080	66.625	59.968	266.500	+/-
VESA CVT, 3840 x 1080	113.250	99.956	453.000	+/-
VESA CVT, 3840 x 1080	137.250	119.974	549.000	+/-
VESA CVT 5120 x 1440	43.797	29.978	231.250	+/-
VESA CVT, 5120 x 1440	88.826	59.977	469.000	+/-

## DisplayPort1/DisplayPort2

Resolution	Horizontal Frequency (kHz)	Vertical Frequency (Hz)	Pixel Clock (MHz)	Sync Polarity (H/V)
IBM, 720 x 400	31.469	70.087	28.322	-/+
MAC, 640 x 480	35.000	66.667	30.240	-/-
MAC, 832 x 624	49.726	74.551	57.284	-/-
MAC, 1152 x 870	68.681	75.062	100.000	-/-
VESA DMT, 640 x 480	31.469	59.940	25.175	-/-

DisplayPort1/DisplayPort2

Resolution	Horizontal Frequency (kHz)	Vertical Frequency (Hz)	Pixel Clock (MHz)	Sync Polarity (H/V)
VESA DMT, 640 x 480	37.861	72.809	31.500	-/-
VESA DMT, 640 x 480	37.500	75.000	31.500	-/-
VESA DMT, 800 x 600	35.156	56.250	36.000	+/+
VESA DMT, 800 x 600	37.879	60.317	40.000	+/+
VESA DMT, 800 x 600	48.077	72.188	50.000	+/+
VESA DMT, 800 x 600	46.875	75.000	49.500	+/+
VESA DMT, 1024 x 768	48.363	60.004	65.000	-/-
VESA DMT, 1024 x 768	56.476	70.069	75.000	-/-
VESA DMT, 1024 x 768	60.023	75.029	78.750	+/+
VESA DMT, 1152 x 864	67.500	75.000	108.000	+/+
VESA DMT, 1280 x 720	45.000	60.000	74.250	+/+
VESA DMT, 1280 x 800	49.702	59.810	83.500	-/+
VESA DMT, 1280 x 1024	63.981	60.020	108.000	+/+
VESA DMT, 1280 x 1024	79.976	75.025	135.000	+/+
VESA DMT, 1440 x 900	55.935	59.887	106.500	-/+
VESA DMT, 1600 x 900	60.000	60.000	108.000	+/+
VESA DMT, 1680 x 1050	65.290	59.954	146.250	-/+
VESA DMT, 1920 x 1080	67.500	60.000	148.500	+/+
CEA, 1920 x 1080	112.500	100.000	297.000	+/+
CEA, 1920 x 1080	135.000	120.000	297.000	+/+
CEA, 2560 x 1080	66.000	60.000	198.000	+/+
CEA, 2560 x 1080	125.000	100.000	371.250	+/+
CEA, 2560 x 1080	150.000	120.000	495.000	+/+
VESA CVT, 2560 x 1440	88.787	59.951	241.500	+/-
VESA CVT, 3840 x 1080	66.625	59.968	266.500	+/-
VESA CVT, 3840 x 1080	113.250	99.956	453.000	+/-

---

## DisplayPort1/DisplayPort2

Resolution	Horizontal Frequency (kHz)	Vertical Frequency (Hz)	Pixel Clock (MHz)	Sync Polarity (H/V)
VESA CVT, 3840 x 1080	137.250	119.974	549.000	+/-
VESA CVT, 5120 x 1440	88.826	59.977	469.000	+/-
VESA CVT, 5120 x 1440	150.994	99.996	797.250	+/-
VESA CVT, 5120 x 1440	182.955	119.970	966.000	+/-

— Horizontal Frequency

The time required to scan a single line from the left to the right side of the screen is called a horizontal cycle. The reciprocal number of a horizontal cycle is called horizontal frequency. Horizontal frequency is measured in kHz.

— Vertical Frequency

Repeating the same picture dozens of times per second allows you to view natural pictures. The repeat frequency is called "vertical frequency" or "refresh rate" and is indicated in Hz.

— This product can be set to only one resolution for each screen size to obtain the optimum picture quality due to the nature of the panel. Using a resolution other than the specified resolution may degrade the picture quality. To avoid this, it is recommended that you select the optimum resolution specified for your product.

# Chapter 11

## Appendix

### Responsibility for the Pay Service (Cost to Customers)

— When the service is requested, in spite of in warranty, we may charge you for a visit from a service technician in the following cases.

#### Not a product defect

Cleaning of the product, Adjustment, Explanation, Re-installation and etc.

- If a service technician gives instructions on how to use product or simply adjusts options without disassembling product.
- If a defect is caused by external environmental factors (Internet, Antenna, Wired Signal, etc.)
- If a product is reinstalled or devices are connected additionally after installing the purchased product for the first time.
- If a product is reinstalled to move to a different spot or to move to a different house.
- If customer requests instructions on how to use because of another company's product.
- If customer requests instructions on how to use the network or another company's program.
- If customer requests software installation and setup for the product.
- If a service technician removes/cleans dusts or foreign materials inside of the product.
- If customer requests an installation additionally after purchasing a product through home-shopping or online.

### A Product damage caused by customer's fault

Product damage caused by customer's mishandling or wrong repair

If a product damage is caused by;

- External impact or drop.
- Use of supplies or separately sold product unspecified by Samsung.
- Repair from a person besides an engineer of outsourcing service company or partner of Samsung Electronics Co., Ltd.
- Remodeling or repairing the product by customer.
- Using it with incorrect voltage or non-authorized electrical connections.
- Not following the "cautions" in User Manual.

#### Others

- If product fails by natural disaster. (lightning, fire, earthquake, flood damage, etc)
- If consumable components are all used up. (Battery, Toner, Fluorescent lights, Head, Vibrator, Lamp, Filter, Ribbon, etc.)

— If customer requests a service in case the product has no defect, service fee may be charged. So please read User Manual first.