



**THE DISPLAY CHOICE
OF PROFESSIONALS™**

www.agneovo.com

FS-24 & FS-27 LED-Backlit Display
User Manual

TABLE OF CONTENTS

SAFETY INFORMATION

WEEE.....	4
-----------	---

PRECAUTIONS

Notice	5
Cautions When Setting Up	5
Cautions When Using.....	6
Cleaning and Maintenance.....	6
Notice for the LCD Display	7

CHAPTER 1: PRODUCT DESCRIPTION

1.1 Package Contents	8
1.2 Installation	9
1.2.1 Installing the Stand.....	9
1.2.2 Adjusting the Viewing Angle and Height.....	10
1.2.3 Wall Mounting.....	11
1.3 Control Buttons.....	12
1.4 Overview	13
1.4.1 Front View	13
1.4.2 Rear View.....	14

CHAPTER 2: MAKING CONNECTIONS

2.1 Connecting the AC Power	15
2.2 Connecting Input Source Signals	16
2.3 Connecting Audio Devices	17

CHAPTER 3: USING THE LCD DISPLAY

3.1 Turning on the Power	18
3.2 Selecting the Input Source Signal	18
3.3 Adjusting the Volume.....	19
3.4 Locking the OSD Menu	20
3.5 Using Auto Adjustment Function	20

CHAPTER 4: ON SCREEN DISPLAY MENU

4.1 Using the OSD Menu	21
4.2 OSD Menu Tree	22

CHAPTER 5: ADJUSTING THE LCD DISPLAY

5.1 Luminance Setting.....	24
5.2 Image Setup Setting.....	25
5.3 Color Temperature Setting	26
5.4 OSD Setup Setting	27
5.5 Extra Setting.....	28

TABLE OF CONTENTS

CHAPTER 6: APPENDIX

6.1 Warning Messages.....	29
6.2 Troubleshooting.....	30
6.3 Transporting the LCD Display	31

CHAPTER 7: SPECIFICATIONS

7.1 Display Specifications	33
7.2 Display Dimensions.....	34

SAFETY INFORMATION

WEEE

Information for users applicable in European Union countries.

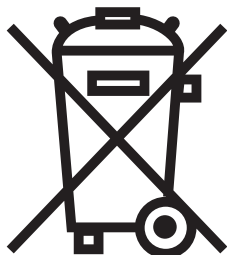

The symbol on the product or its packaging signifies that this product has to be disposed separately from ordinary household wastes at its end of life. Please kindly be aware that this is your responsibility to dispose electronic equipment at recycling centers so as to help conserve natural resources. Each country in the European Union should have its collection centers for electrical and electronic equipment recycling. For information about your recycling drop off area, please contact your local related electrical and electronic equipment waste management authority or the retailer where you bought the product.

PRECAUTIONS

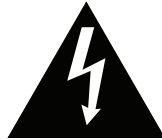

CAUTION
RISK OF ELECTRIC SHOCK
DO NOT OPEN



Symbols used in this manual

	This icon indicates the existence of a potential hazard that could result in personal injury or damage to the product.
	This icon indicates important operating and servicing information.

Notice

- Read this User Manual carefully before using the LCD display and keep it for future reference.
- The product specifications and other information provided in this User Manual are for reference only. All information is subject to change without notice. Updated content can be downloaded from our web site at <http://www.agneovo.com>.
- To register online, go to <http://www.agneovo.com>.
- To protect your rights as a consumer, do not remove any stickers from the LCD display. Doing so may affect the determination of the warranty period.

Cautions When Setting Up



Do not place the LCD display near heat sources, such as a heater, exhaust vent, or in direct sunlight.



Do not cover or block the ventilation holes in the housing.



Place the LCD display on a stable area. Do not place the LCD display where it may be subject to vibration or shock.



Place the LCD display in a well-ventilated area.



Do not place the LCD display outdoors.



Do not place the LCD display in a dusty or humid environment.



Do not spill liquid or insert sharp objects into the LCD display through the ventilation holes. Doing so may cause accidental fire, electric shock or damage the LCD display.

PRECAUTIONS

Cautions When Using



Use only the power cord supplied with the LCD display.



The power outlet should be installed near the LCD display and be easily accessible.



If an extension cord is used with the LCD display, ensure that the total current consumption plugged into the power outlet does not exceed the ampere rating.



Do not allow anything to rest on the power cord. Do not place the LCD display where the power cord may be stepped on.



If the LCD display will not be used for an indefinite period of time, unplug the power cord from the power outlet.



To disconnect the power cord, grasp and pull by the plug head. Do not tug on the cord; doing so may cause fire or electric shock.



Do not unplug or touch the power cord with wet hands.

Cleaning and Maintenance



Use a soft cloth lightly moistened with a mild detergent solution to clean the glass surface and the housing.



Do not rub or tap the surface of the glass with sharp or abrasive items such as a pen or screwdriver. This may result in scratching the surface of the glass.



Do not attempt to service the LCD display yourself, refer to qualified service personnel. Opening or removing the covers may expose you to dangerous voltage or other risks.



Warning:



Unplug the power cord from the power outlet and refer to qualified service personnel under the following conditions:

- ◆ When the power cord is damaged.
- ◆ If the LCD display has been dropped or the housing has been damaged.
- ◆ If the LCD display emits smoke or a distinct odor.



Warning:



Ceiling mount or mount on any other horizontal surface overhead are not advisable.

Installation in contravention of the instructions may result in undesirable consequences, particularly hurting people and damaging property. Users who have already mounted the display on the ceiling or any other horizontal surface overhead are strongly advised to contact AG Neovo for consultations and solutions to help ensure a most pleasurable and fulfilling display experience.

PRECAUTIONS

Notice for the LCD Display

In order to maintain the stable luminous performance, it is recommended to use low brightness setting.

Due to the lifespan of the lamp, it is normal that the brightness quality of the LCD display may decrease with time.

When static images are displayed for long periods of time, the image may cause an imprint on the LCD display. This is called image retention or burn-in.

To prevent image retention, do any of the following:

- Set the LCD display to turn off after a few minutes of being idle.
- Use a screen saver that has moving graphics or a blank white image.
- Switch desktop backgrounds regularly.
- Adjust the LCD display to low brightness settings.
- Turn off the LCD display when the system is not in use.

Things to do when the LCD display shows image retention:

- Turn off the LCD display for extended periods of time. It can be several hours or several days.
 - Use a screen saver and run it for extended periods of time.
 - Use a black and white image and run it for extended periods of time.
-

When the LCD display is moved from one room to another or there is a sudden change from low to high ambient temperature, dew condensation may form on or inside the glass surface. When this happens, do not turn on the LCD display until the dew disappears.

Due to humid weather conditions, it is normal for mist to form inside the glass surface of the LCD display. The mist will disappear after a few days or as soon as the weather stabilizes.

There are millions of micro transistors inside the LCD display. It is normal for a few transistors to be damaged and to produce spots. This is acceptable and is not considered a failure.

CHAPTER 1: PRODUCT DESCRIPTION

1.1 Package Contents

When unpacking, check if the following items are included in the package. If any of them is missing or damaged, contact your dealer.

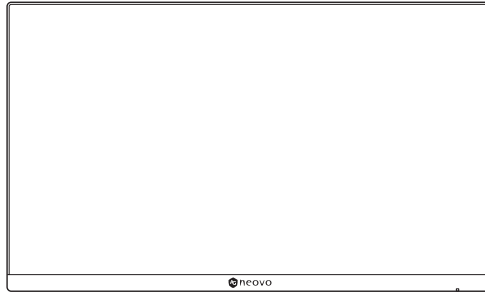

LCD display

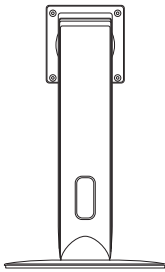

Stand



Stand screws

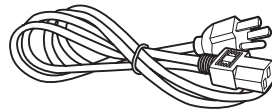

Power cord

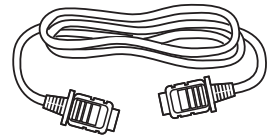

HDMI cable

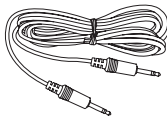

Audio cable



Quick start guide

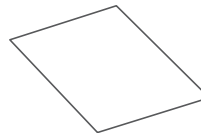

Warranty card

Note:

- The pictures are for reference only. Actual items may vary upon shipment.

PRODUCT DESCRIPTION

1.2 Installation

1.2.1 Installing the Stand

1. Place the LCD display with the screen side down on a cushioned surface.
2. Attach the stand to the LCD display.
 - a. Align and attach the stand to the rear of the LCD display.
 - b. Use the screws to secure the stand.
3. Rotate the stand 90° clockwise. Then set the LCD display up in an upright position.

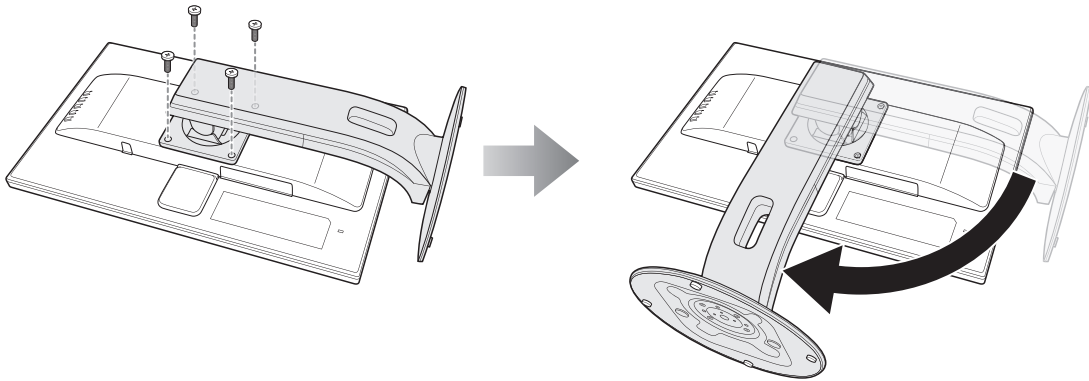

PRODUCT DESCRIPTION

1.2.2 Adjusting the Viewing Angle and Height

For optimal viewing, it is recommended to look at the full face of the screen, then adjust the screen of the LCD display angle and height according to your preference.

Hold the stand so that the screen does not topple when you make the adjustment.

You are able to adjust the screen angle and height as below:

Tilt angle:

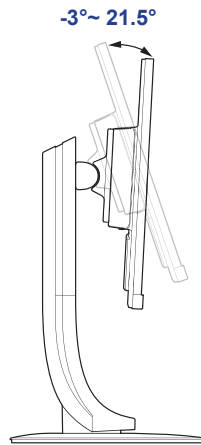

Pivot angle:

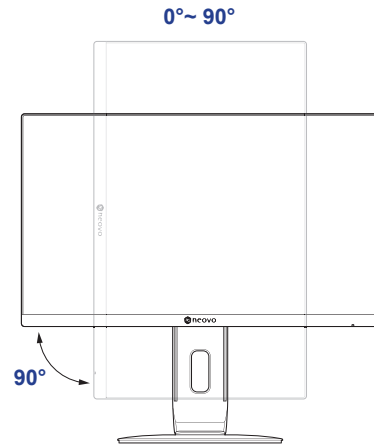

Note: Before making the adjustment, make sure to adjust the height to the highest position, and then tilt the screen 90° .

Swivel angle:

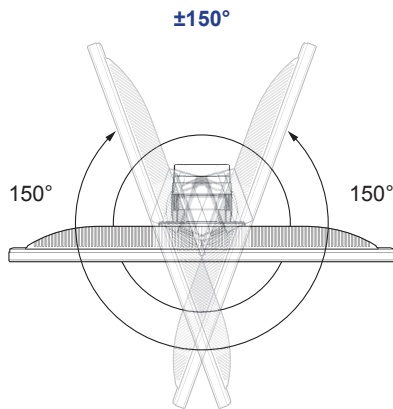

Height adjustment:

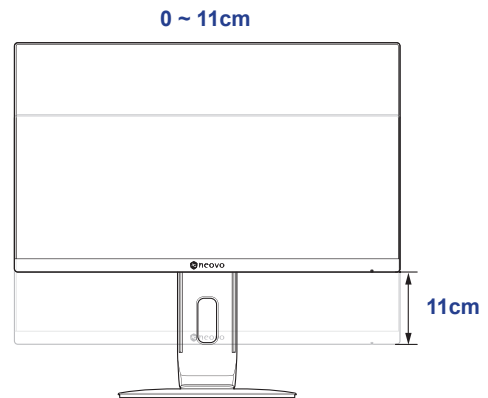

PRODUCT DESCRIPTION

1.2.3 Wall Mounting

To wall mount the LCD display, do the following steps:

1. Remove the stand.

Please refer to page 36.

2. Wall mount the LCD display.

Screw the mounting bracket to the VESA holes at the rear of the LCD display.

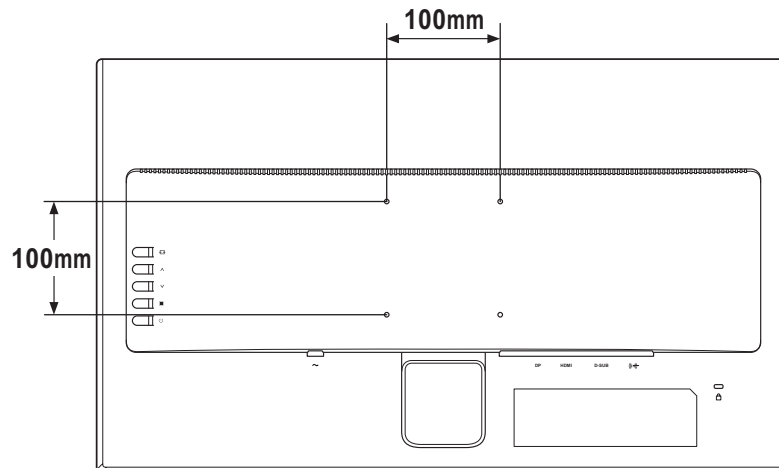

Note: Take measures to prevent the LCD display from falling down and lessen possible injury and damage to the display in case of earthquakes or other disasters.

- Use only the 100 x 100 mm wall mount kit recommended by AG Neovo. All AG Neovo wall mount kits comply with VESA standard.
- Secure the LCD display on a solid wall strong enough to bear its weight.
- It is suggested to wall mount the LCD display without tilting it facing downward.

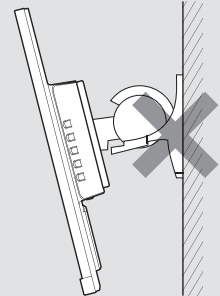

PRODUCT DESCRIPTION

1.3 Control Buttons

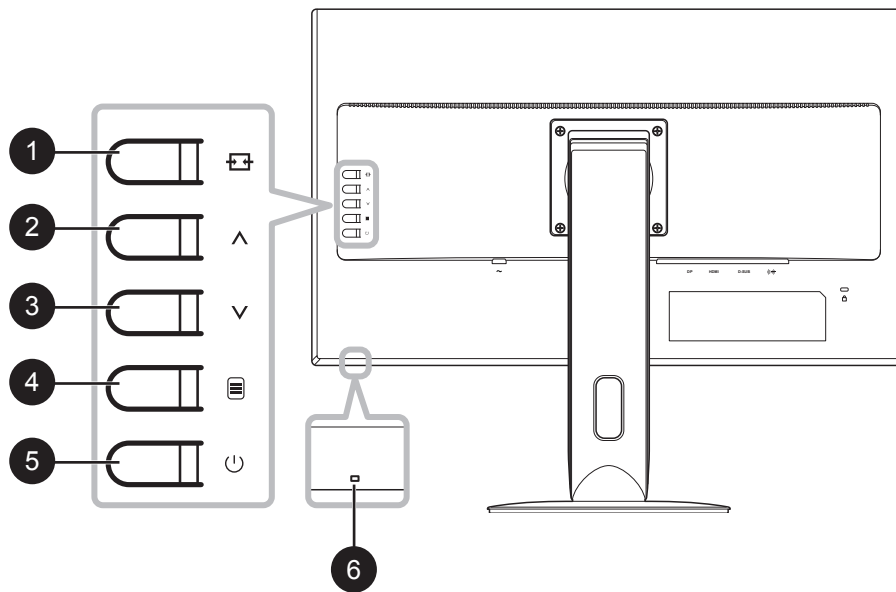

1 [] AUTO/SOURCE/EXIT

- Call out the **Source** quick menu. Then press the [] button repeatedly to switch the input source. Refer to page 23.
- For VGA input signal, press and hold the [] button to perform auto adjustment. Refer to page 25.
- During OSD menu, close the OSD menu or exit a submenu.
- During volume adjustment or Eco mode selection, close the respective quick menu.

2 [^] Up

- Call out the **Volume** quick menu. Then press the [^] button to adjust the volume level. Refer to page 24.
- For HDMI input signal, you can configure the audio input source. Refer to page 24.
- During OSD menu, scroll through the menu options, select an option, and adjust the settings.

3 [v] Down

- Call out the **Eco Mode** quick menu. Then press the [v] button to select the desired setting.
- During OSD menu, scroll through the menu options, select an option, and adjust the settings.

4 [] MENU/ENTER

- Call out the OSD menu when OSD menu is off.
- During OSD menu, confirm the selection or enter a submenu.

5 [] Power

Turn the LCD display on. Press it again to turn the LCD display off. Refer to page 23.

6 Power indicator

Indicate the operating status of the LCD display:

- Lights blue when the LCD display is turned on.
- Blinks orange when the LCD display is in standby mode.
- Lights off when the LCD display is turned off.

PRODUCT DESCRIPTION

1.4 Overview

1.4.1 Front View

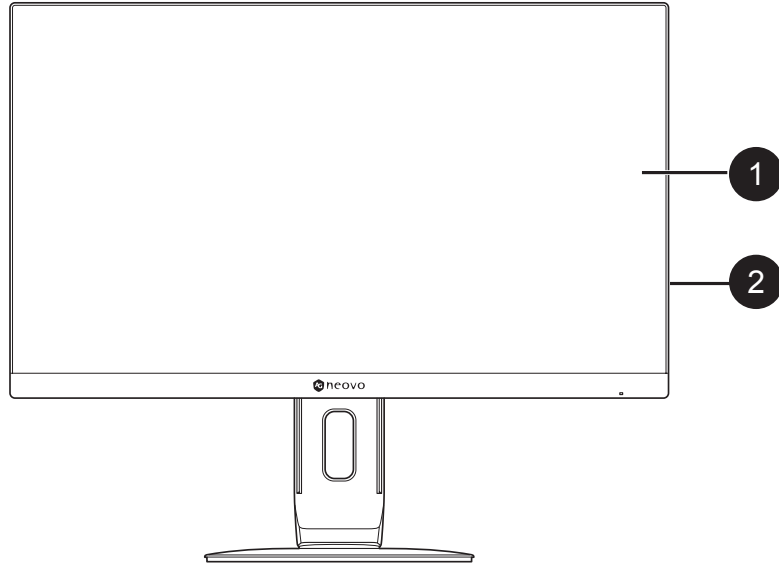

1 Display screen

2 Control buttons

Press the button to perform its function. For more information about each button, refer to page 12.

PRODUCT DESCRIPTION

1.4.2 Rear View

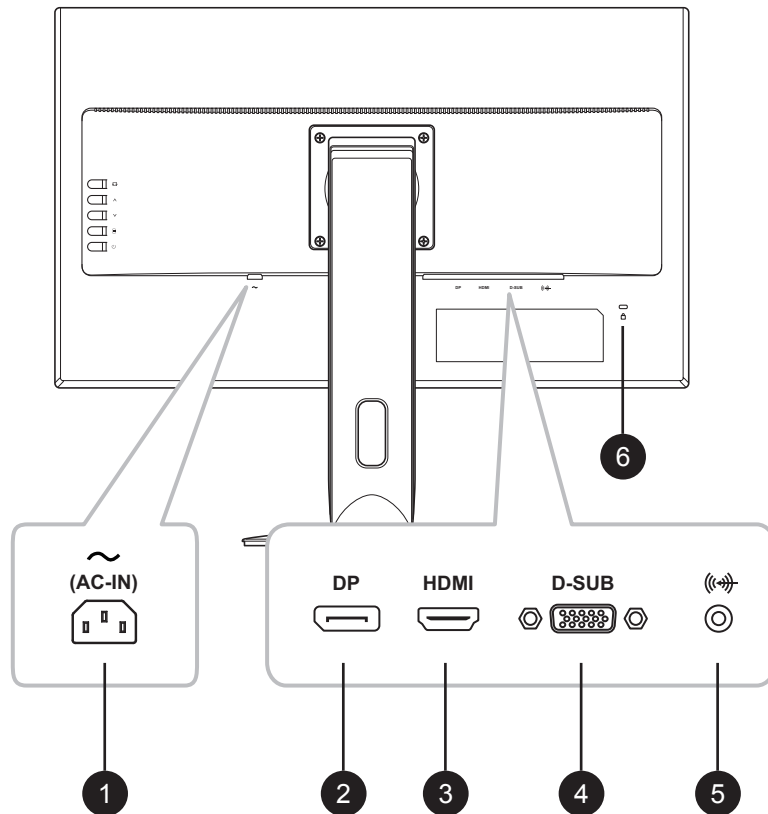

1 Power Input

Connect the power cord to the power input.

2 DP(DisplayPort) connector

Use to connect DP cable for digital input signal.

3 HDMI connector

Use to connect an HDMI cable for digital input signal.

4 D-SUB (VGA) connector

Use to connect a D-Sub (VGA) cable for analogue input signal.

5 Audio port

Use to connect an audio cable for audio input.

6 Kensington lock socket

Use to physically lock the system to prevent theft.

The locking device is sold separately. To purchase, contact your retailer.

CHAPTER 2: MAKING CONNECTIONS



CAUTION:

Make sure that the LCD display is not connected to the power outlet before making any connections. Connecting cables while the power is ON may cause possible electric shock or personal injury.

2.1 Connecting the AC Power

1. Connect the power cord to the AC power input at the rear of the LED-backlit display.
2. Connect the plug to a power outlet or power supply.

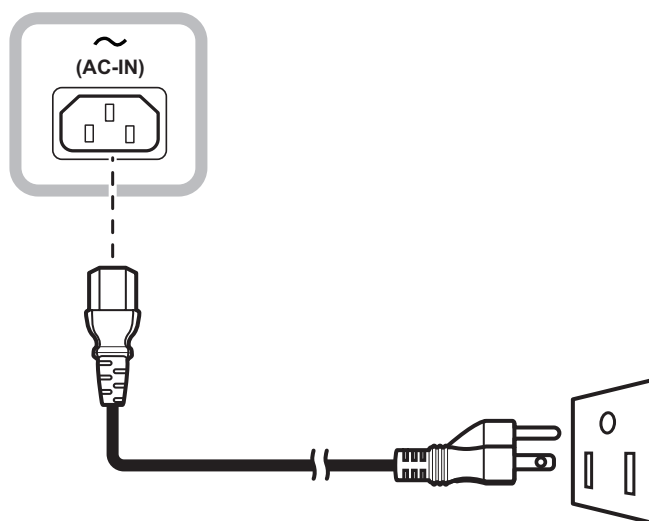

CAUTION:

When unplugging the power cord, hold the power cord by the plug head. Never pull by the cord.

MAKING CONNECTIONS

2.2 Connecting Input Source Signals

Input source signals can be connected with either of the following cables:

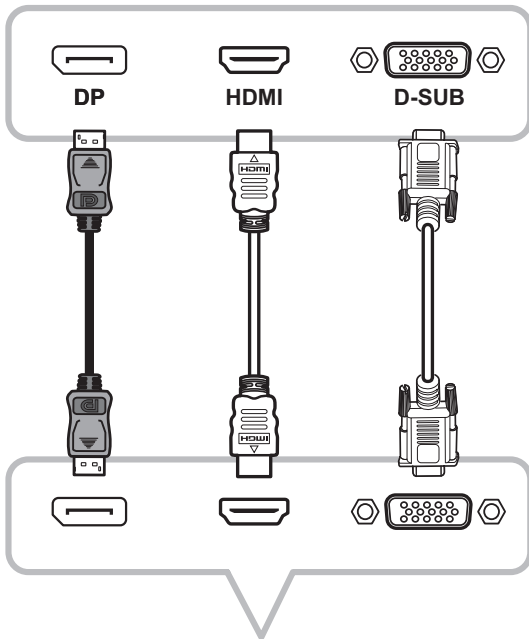

- **DP**

Connect one end of an DP cable to the DP connector of the LCD display and the other end to the DP connector of the computer.

- **VGA**

Connect one end of a D-Sub (VGA) cable to the D-SUB (VGA) connector of the LCD display and the other end to the VGA connector of the computer.

- **HDMI**

Connect one end of an HDMI cable to the HDMI connector of the LCD display and the other end to the HDMI connector of the computer.

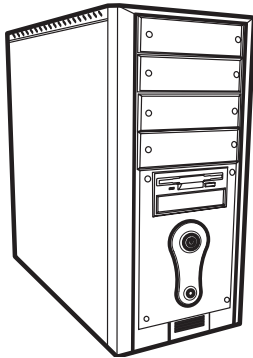

MAKING CONNECTIONS

2.3 Connecting Audio Devices

1. Connect one end of an audio cable to the audio port at the rear of the LCD display.
2. Connect the other end of an audio cable to the audio out port of the computer.

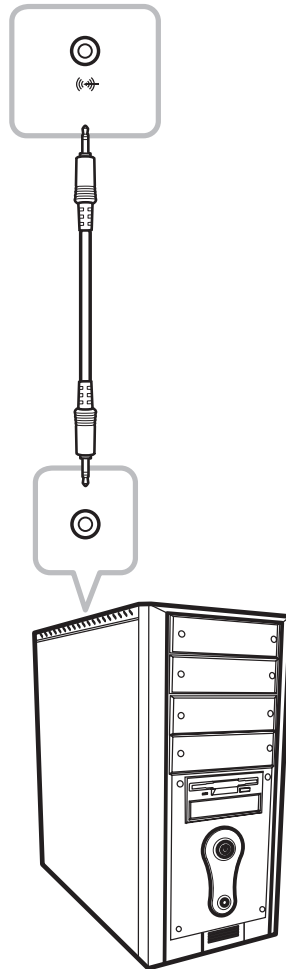

CHAPTER 3: USING THE LCD DISPLAY

3.1 Turning on the Power

1. Plug the power cord to a power outlet or power supply.
2. Press the  button to turn the LCD display on.

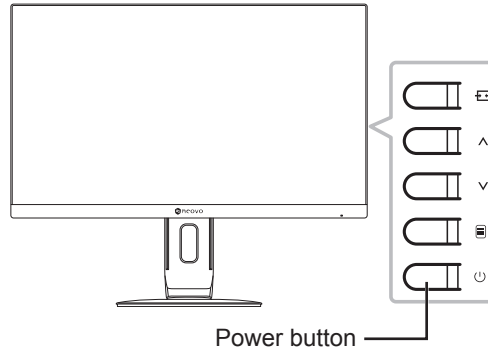

When the LCD display is turned on, press the  button to turn off the LCD display.

Note: The LCD display still consumes power as long as the power cord is connected to the power outlet. Disconnect the power cord to completely cut off power.

3.2 Selecting the Input Source Signal

1. Press the  button to call out the **Source** quick menu.

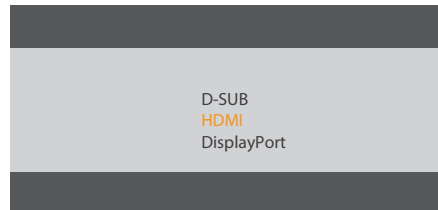

2. Press the  button repeatedly to switch the input source.

USING THE LCD DISPLAY

3.3 Adjusting the Volume

1. Press the \wedge button to call out the *Volume* quick menu.

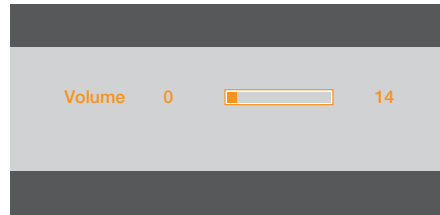

2. Press the \wedge or \vee button to adjust the volume.

Note:

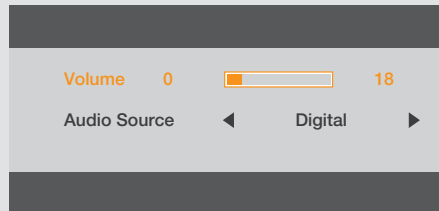

- During volume or menu setting adjustment, press and hold the $\wedge\vee$ button to change the values continuously.
- For HDMI input signal, the **Audio Source** option will appear on the screen when you press the \wedge button.





To configure the audio input source, press the  button to select **Audio Source**. Then use the $\wedge\vee$ button to select the desired setting (Line in/Digital).

USING THE LCD DISPLAY

3.4 Locking the OSD Menu

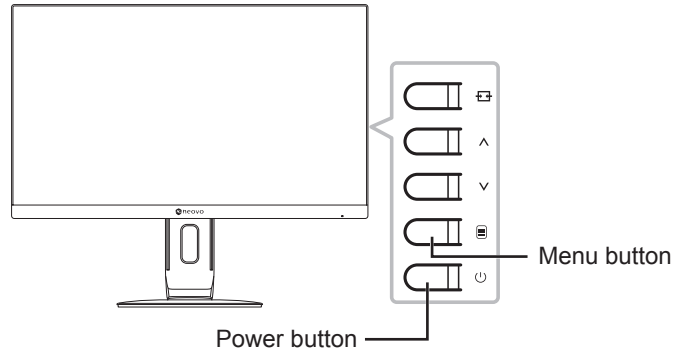
To lock the OSD menu, press and hold the  button while the LCD display is off, and then press the  button to turn the LCD display on.



To unlock the OSD menu, press and hold the  button while the LCD display is off, and then press the  button to turn the LCD display on.

3.5 Using Auto Adjustment Function

Press and hold the  button to perform auto adjustment. This function automatically tunes the LCD display to its optimal setting, including horizontal position, vertical position, clock, and phase. When auto adjustment is initiated, the below message is displayed on the screen.

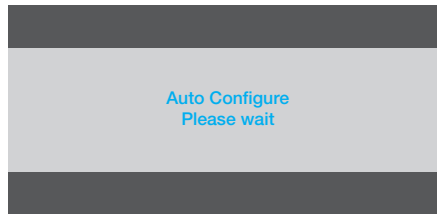

When the message disappears, this indicates the auto adjustment is completed.

Note:

- *During auto adjustment, the screen will slightly shake for a few seconds.*
- *It is recommended to use the auto adjustment function when using the LCD display for the first time or after a resolution or frequency change.*

CHAPTER 4: ON SCREEN DISPLAY MENU

4.1 Using the OSD Menu

1. Press the  button to call out the OSD window.

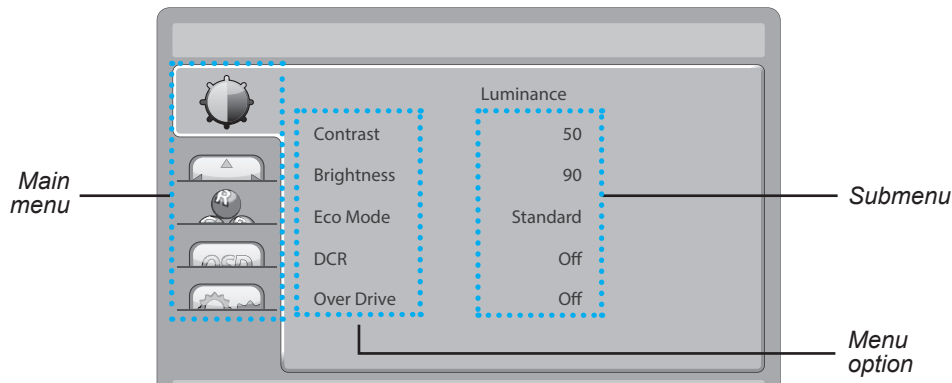

2. Press the \wedge or \vee button to select a menu and press the  button to enter the selected menu.

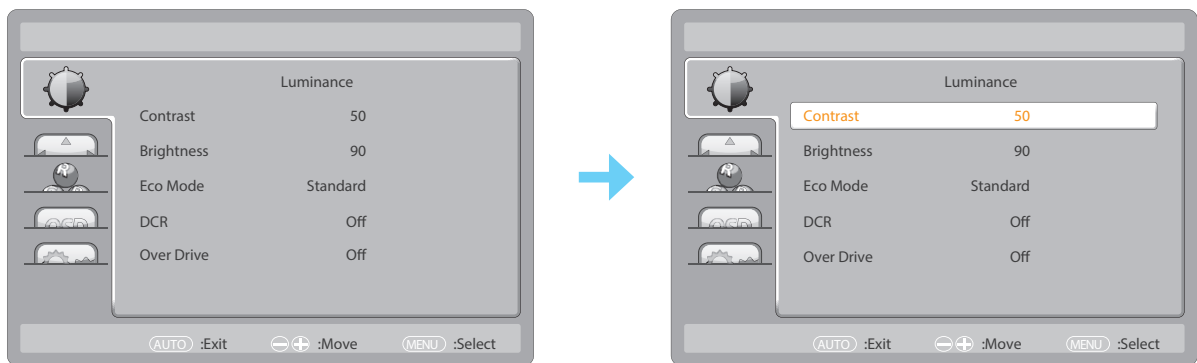

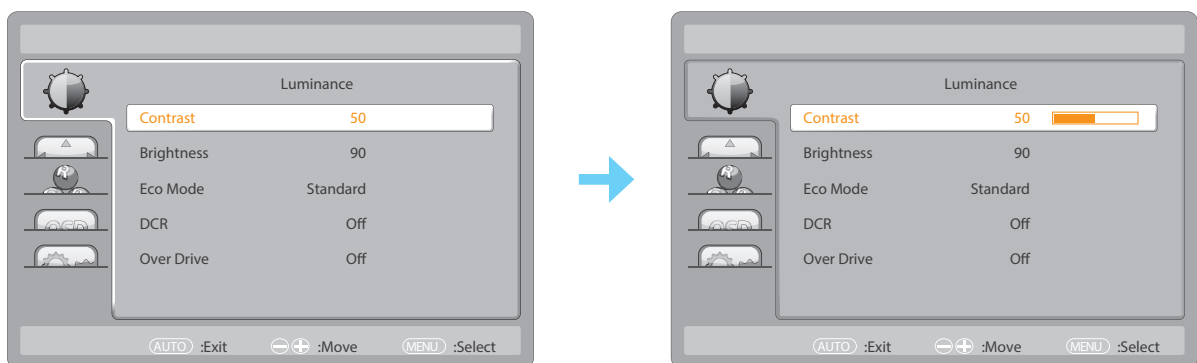

The selected menu icon appears on the left panel and the text of the selected menu option turns orange.

3. Press the \wedge or \vee button to select an option and press the  button to enter its submenu.



The text of the selected menu option or submenu turns orange.



4. Press the \wedge or \vee button to adjust the settings.
5. To exit the submenu, press the  button.
6. To close the OSD window, press the  button twice.

Note: When settings are modified, all changes are saved when the user does the following:



- Proceeds to another menu
- Exits the OSD menu
- Waits for the OSD menu to disappear

ON SCREEN DISPLAY MENU

4.2 OSD Menu Tree

Main Menu	Submenu		Reference	
Luminance ()	Contrast		Refer to page 24.	
	Brightness			
	Eco Mode	Text		
		Internet		
		Game		
		Movie		
		Sports		
		Standard		
	DCR	Off		
		On		
Over Drive	Off			
	On			
Image Setup ()	Clock		Refer to page 25.	
	Phase			
	H. Position			
	V. Position			
	Image Ratio	Wide		
		4:3		
Color Temp. ()	Color Temp.	Warm	Refer to page 26.	
		Normal		
		Cool		
		User		
		sRGB		
	Red			
	Green			
	Blue			
	Blue Light Filter	Off		
		On		



ON SCREEN DISPLAY MENU

Main Menu	Submenu		Reference	
OSD Setup 	H. Position		Refer to page 27.	
	V. Position			
	Timeout			
	Language	English		
		Spanish		
		French		
		Portuguese		
		Russian		
		Simplified Chinese		
Traditional Chinese				
Korean				
Extra 	Input Select	Auto	Refer to page 28.	
		DisplayPort		
		HDMI		
		D-SUB		
	DDC/CI	On		
		Off		
	Reset	Yes		
		No		
Information				

Note: Availability of some menu items depend on the input source signal and current setting. If the menu is not available, it is disabled and grayed out.

CHAPTER 5: ADJUSTING THE LCD DISPLAY

5.1 Luminance Setting

1. Press the  button to call out the OSD window.
2. Press the \wedge or \vee button to select  and press the  button to enter the Luminance menu.

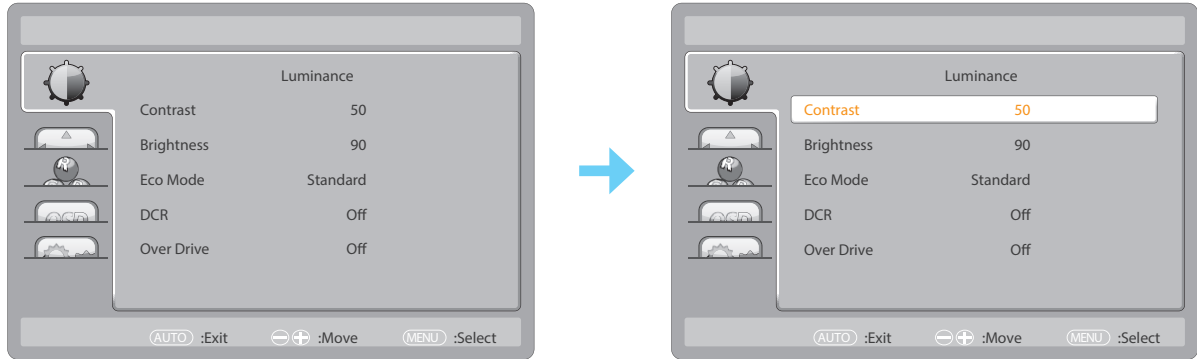



3. Press the \wedge or \vee button to select an option and press the  button to enter its submenu.

Item	Function	Operation	Range
Contrast	Adjusts the difference between the black level and the white level.	Press the \wedge or \vee button to adjust the value.	0 to 100
Brightness	Adjusts the luminance of the screen image.		
Eco Mode	Chooses a predefined picture setting.	Press the \wedge or \vee button to select the setting.	Text Internet Game Movie Sports Standard
DCR (Dynamic Contrast Ratio)	Activates DCR. This feature provides automatic adjustment of picture brightness and contrast at high speed and dynamic contrast range, such as when watching movies. DCR is suitable for indoor viewing.		On Off
Over Drive	Enhances the monitor response time.		Off Weak Strong

ADJUSTING THE LCD DISPLAY

5.2 Image Setup Setting

1. Press the  button to call out the OSD window.
2. Press the \wedge or \vee button to select  and press the  button to enter the Image Setup menu.

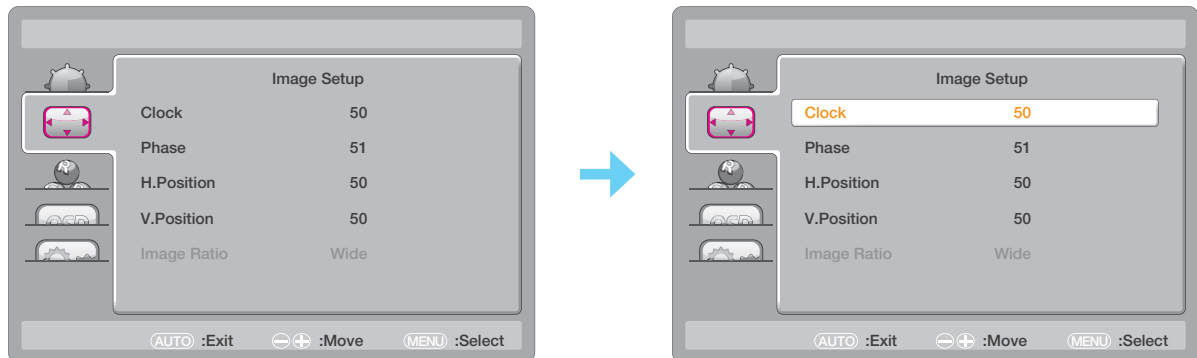



3. Press the \wedge or \vee button to select an option and press the  button to enter its submenu.

Item	Function	Operation	Range
Clock	Adjusts the frequency timing to synchronise with the video signal. Note: <i>This menu option is only available if the input source is VGA.</i>	Press the \wedge or \vee button to adjust the value.	0 to 100
Phase	Adjusts the phase timing to synchronise with the video signal. Note: <i>This menu option is only available if the input source is VGA.</i>		
H. Position (Horizontal Position)	Moves the screen image to the left or right. Note: <i>This menu option is only available if the input source is VGA.</i>		
V. Position (Vertical Position)	Moves the screen image up or down. Note: <i>This menu option is only available if the input source is VGA.</i>		
Image Ratio	Selects the aspect ratio of the screen image.	Press the \wedge or \vee button to select the setting.	Wide 4:3



ADJUSTING THE LCD DISPLAY

5.3 Color Temperature Setting

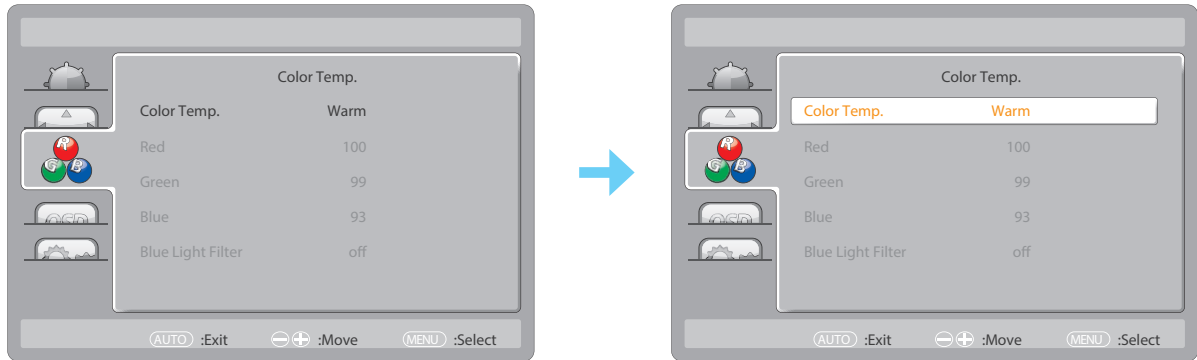
1. Press the  button to call out the OSD window.
2. Press the \wedge or \vee button to select  and press the  button to enter the Color Temp. menu.



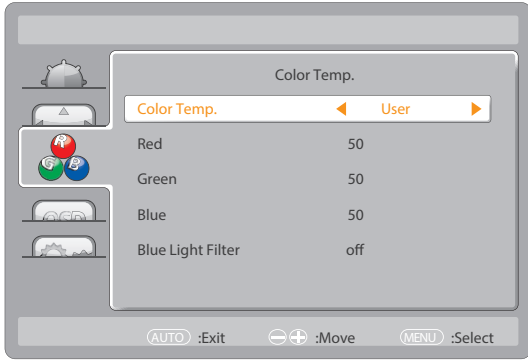

3. Press the \wedge or \vee button to select an option and press the  button to enter its submenu.

Item	Function	Operation	Range
Color Temp. (Color Temperature)	Provides several color adjustment settings.	Press the \blacktriangleleft or \blacktriangleright button to select the setting.	Warm Normal Cool sRGB User
	<p>If the Color Temp. setting is set to User, you can customize the color temperature by adjusting the red, green, or blue setting according to your preference.</p>  <ol style="list-style-type: none"> Select User and press the  button. Press the \wedge or \vee button to select the color you want to adjust. Then press the  button to enter its submenu. Press the \wedge or \vee button to adjust the value (0 ~ 100). 		
Blue Light Filter	Reduces the blue light intensity	Press the \blacktriangleleft or \blacktriangleright button to select the setting.	On Off

ADJUSTING THE LCD DISPLAY

5.4 OSD Setup Setting

1. Press the  button to call out the OSD window.
2. Press the \wedge or \vee button to select  and press the  button to enter the OSD Setup menu.

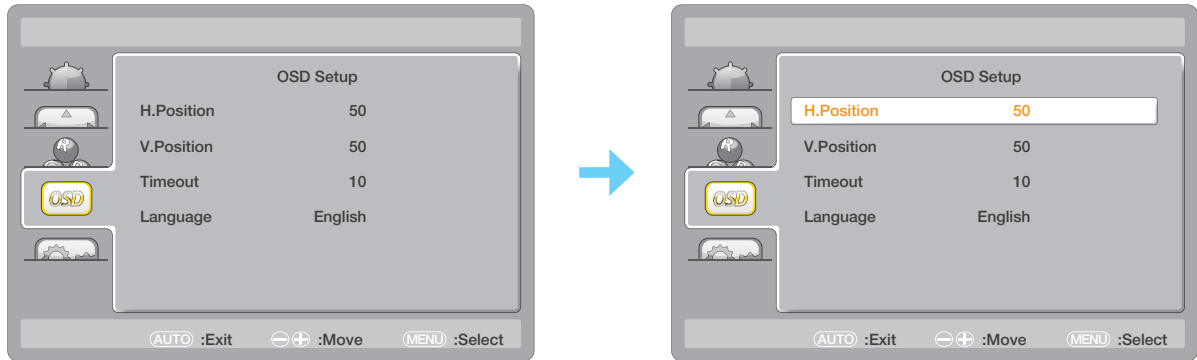





3. Press the \wedge or \vee button to select an option and press the  button to enter its submenu.

Item	Function	Operation	Range
H. Position (Horizontal Position)	Moves the OSD window to the left or right of the screen.	Press the \wedge or \vee button to adjust the value.	0 to 100 (increment by 5)
V. Position (Vertical Position)	Moves the OSD window up or down the screen.		
Timeout	Sets the length of time (in seconds) the OSD screen is displayed. When the time elapses, the OSD screen is automatically inactivated.		5 to 100 (increment by 5)
Language	Choose the language used for OSD menus.	Press the \wedge or \vee button to select the setting.	English Spanish French Portuguese Russian Simplified Chinese Traditional Chinese Korean



ADJUSTING THE LCD DISPLAY

5.5 Extra Setting

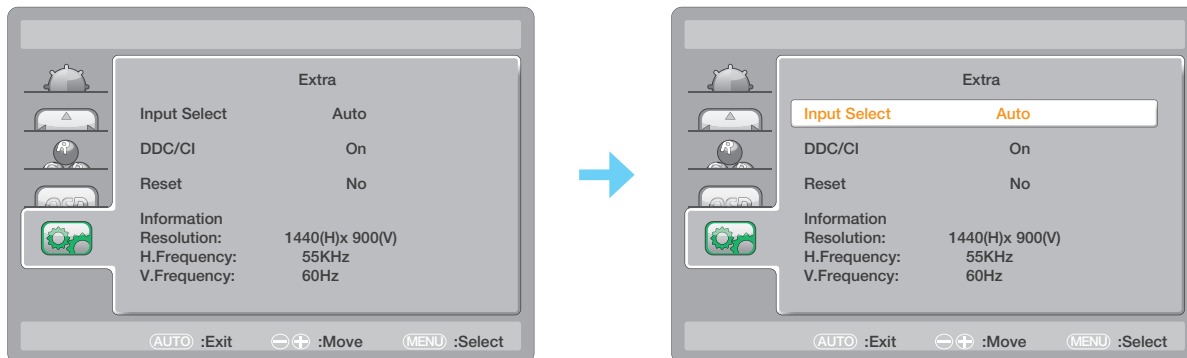
1. Press the  button to call out the OSD window.
2. Press the  or  button to select  and press the  button to enter the Extra menu.



3. Press the  or  button to select an option and press the  button to enter its submenu.

Item	Function	Operation	Range
Input Select	Switches the input source when two input signals are connected.	Press the  or  button to select the setting.	Auto DisplayPort HDMI D-Sub
DDC/CI	Activates the DDC/CI protocol to allow users to configure the monitor by a software using a VGA cable.		On Off
Reset	Resets all your customized settings to the factory defaults.		Yes No
Information	Displays the information of the input source such as Resolution, Horizontal Frequency, and Vertical Frequency.	-	-

CHAPTER 6: APPENDIX

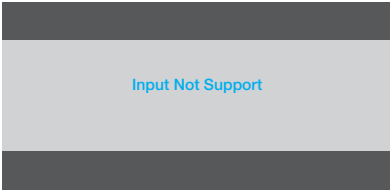
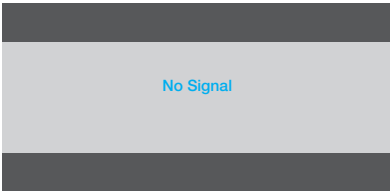

6.1 Warning Messages

When any of these warning messages appear, check the following items.

Warning Message	Cause	Solution
 A screenshot of a warning message box with a dark grey header and footer, and a light grey background. The text "Input Not Support" is displayed in blue.	The resolution or the refresh rate of the graphics card of the computer is set too high.	√ Change the resolution or the refresh rate of the graphics card.
 A screenshot of a warning message box with a dark grey header and footer, and a light grey background. The text "No Signal" is displayed in blue.	The LCD display cannot detect the input source signal.	√ Check if the input source is turned ON. √ Check if the signal cable is properly connected. √ Check if any pin inside the cable connector is twisted or broken.

APPENDIX

6.2 Troubleshooting

Problems	Possible Cause and Solution
No picture. <ul style="list-style-type: none"> • LED indicator is OFF. 	<ul style="list-style-type: none"> • Check if the LCD display is turned ON. • Check if the power adapter is properly connected to the LCD display. • Check if the power cord is plugged into the power outlet.
<ul style="list-style-type: none"> • LED indicator is blue. 	<ul style="list-style-type: none"> • Check if the computer is turned ON. • Check if the computer is in standby mode, move the mouse or press any key to wake up the computer.
Image position is incorrect.	<ul style="list-style-type: none"> • For VGA input, adjust the H. Position and V. Position settings in Image Setup () menu (refer to page 30).
The displayed texts are blurry.	<ul style="list-style-type: none"> • For VGA input, do the following: <ul style="list-style-type: none"> √ Press and hold the  button to auto-adjust the display (refer to page 25). √ Adjust the Clock and Phase settings in Image Setup () menu (refer to page 30).
Red, blue, green, white dots appear on the screen.	<ul style="list-style-type: none"> • There are millions of micro transistors inside the LCD display. It is normal for a few transistors to be damaged and to produce spots. This is acceptable and is not considered a failure.
No audio output.	<ul style="list-style-type: none"> • Check if the volume is set to 0 (refer to page 24). • For VGA input, check the audio setting of the computer.
Dew formed on the LCD display.	<ul style="list-style-type: none"> • This normally happens when the LCD display is moved from a cold room to a hot room temperature. Do not turn ON the LCD display, wait for the dew condensation to disappear.
Faint shadows from a static image appear on the screen.	<ul style="list-style-type: none"> • Turn off the LCD display for extended periods of time. • Use a screen saver or a black and white image and run it for extended periods of time.

APPENDIX

6.3 Transporting the LCD Display

To transport the LCD display for repair or shipment, place the display in its original packaging box.

1. Remove the stand.

- a. Place the LCD display with the screen side down on a cushioned surface.
- b. Rotate the stand 90° counter-clockwise. Then remove the screws securing the stand to the LCD display.
- c. Remove the stand.

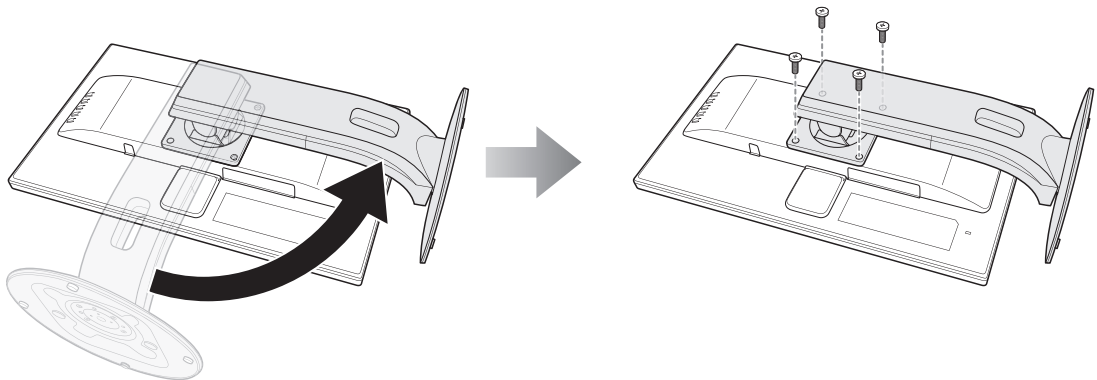

2. Put the LCD display inside its original plastic. Then place the LCD display with the screen side down on the foam cushion.
3. Put all other contents on their designated area (if necessary).
4. Close and tape the box.

APPENDIX

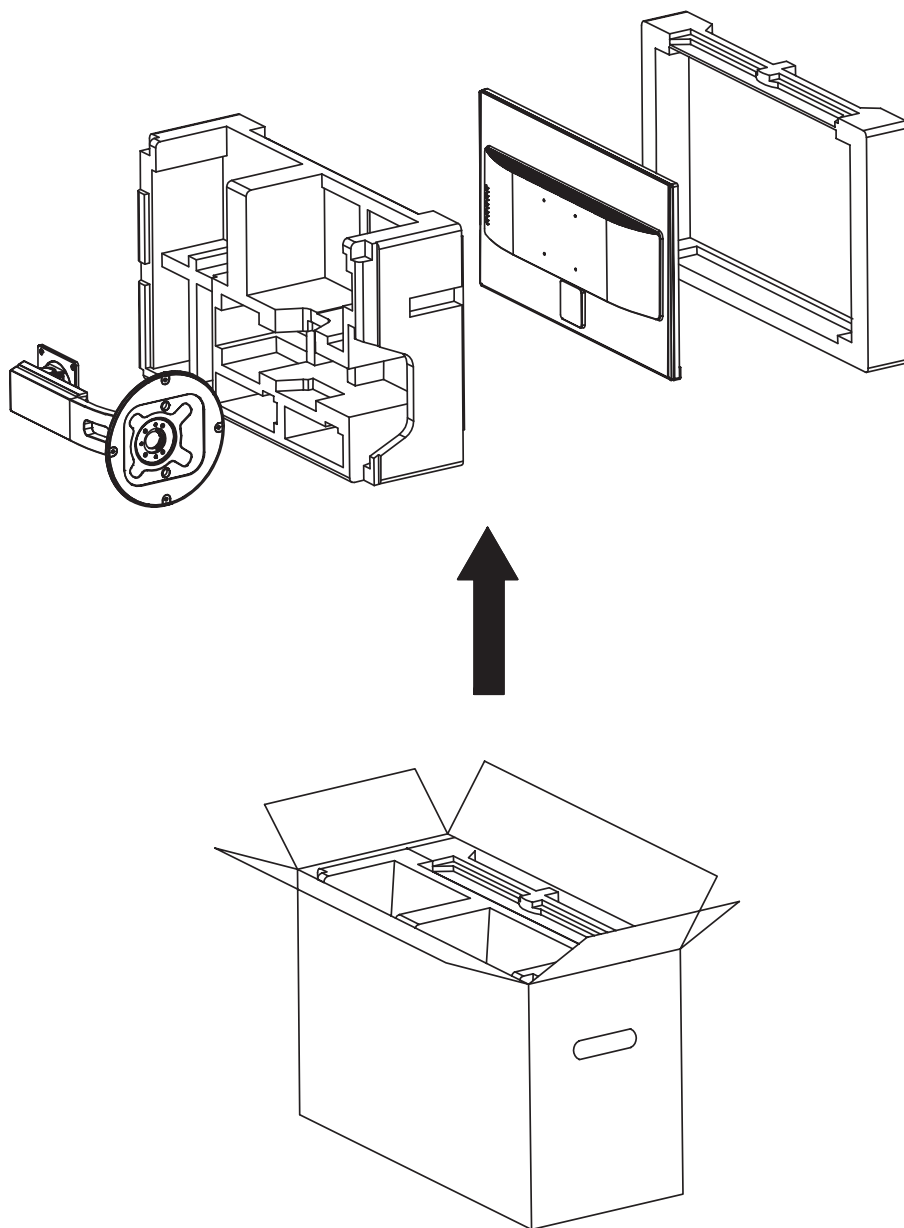

Note:

- *It is recommended to use the original packaging box.*
- *When repacking, carefully place the LCD display in its box and protect the glass panel from touching any object.*

CHAPTER 7: SPECIFICATIONS

7.1 Display Specifications

Item		Model Name	
		FS-24	FS-27
Electrical Characteristics			
Panel	Panel Size	23.8"	27.0"
	Max. Resolution	1920 x 1080	
	Brightness	250 cd/m ²	300 cd/m ²
	Contrast Ratio	1000:1	
	Viewing Angle (H/V)	178°/178°	
	Display Color	16.7 M	
	Response Time	5 ms	
Frequency (H/V)		H: 30 kHz – 83 kHz V: 56 Hz – 75 Hz	
Input	VGA	15-Pin D-Sub	
	HDMI	HDMI 1.4	
	Display Port	DisplayPort 1.2a	
Audio	Audio In	1 x stereo audio jack for PC (audio jack, 3.5 Ø)	
	Speaker	2W x 2	
Power	Power Supply	Internal	
	Power Requirements	100 - 240V AC, 50/60 Hz	
	Consumption	< 35W (On) < 0.5W (Standby/Off)	< 55W (On) < 0.5W (Standby/Off)
Physical Characteristics			
Operating Conditions	Temperature	0°C ~ 40°C (32°F ~ 104°F)	
	Humidity	10% ~ 85% (No condensation)	
Storage Conditions	Temperature	-25°C ~ 55°C (-13°F ~ 130°F)	
	Humidity	5% ~ 93% (No condensation)	
Dimensions (W x H x D)		541 x 499 x 249 mm (21.3" x 19.6" x 9.8")	612 x 518 x 249 mm (24.1" x 20.4" x 9.8")
Packaging		632 x 417 x 282 mm (24.9" x 16.4" x 11.1")	715 x 450 x 305 mm (28.1" x 17.7" x 12.0")
Weight		5.7 kg (12.57 lb)	6.6 kg (14.6 lb)
Packaging		7.8 kg (17.2 lb)	8.9 kg (19.6 lb)

Note: All specifications are subject to change without prior notice.

SPECIFICATIONS

7.2 Display Dimensions

FS-24

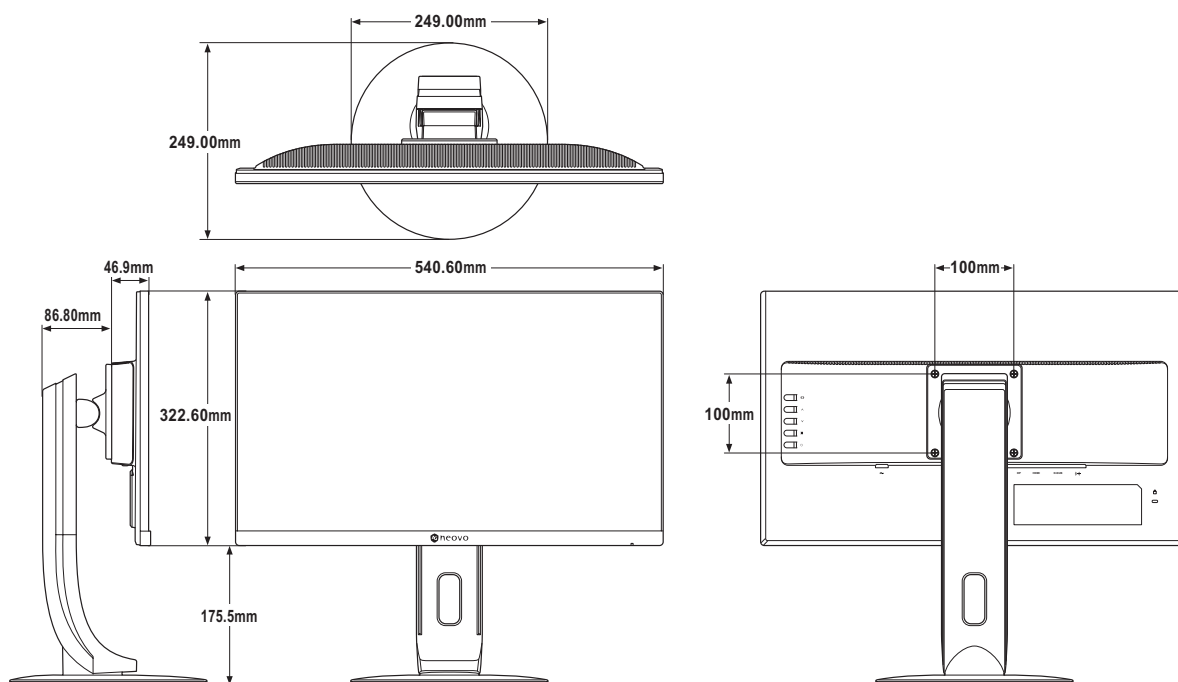

FS-27

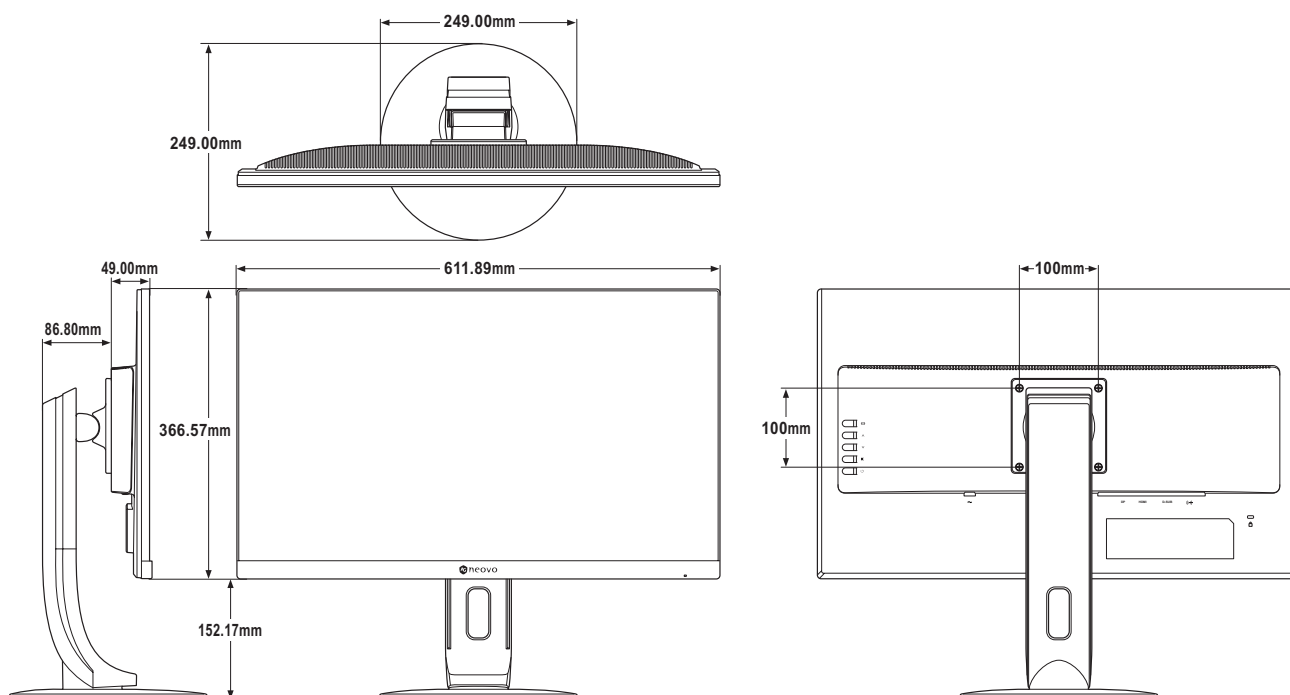

AG Neovo

Company Address: 5F-1, No. 3-1, Park Street, Nangang District, Taipei, 11503, Taiwan.

Copyright © 2018 AG Neovo. All rights reserved.

FS-24/FS-27_UM_V010