

USER MANUAL

ProLite

LCD Monitor

ENGLISH

ProLite T5561UHSC
ProLite T4361MSC

Thank you very much for choosing the iiyama LCD monitor.

We recommend that you take a few minutes to read this comprehensive manual carefully before installing and switching on the monitor. Please keep this manual in a safe place for your future reference.

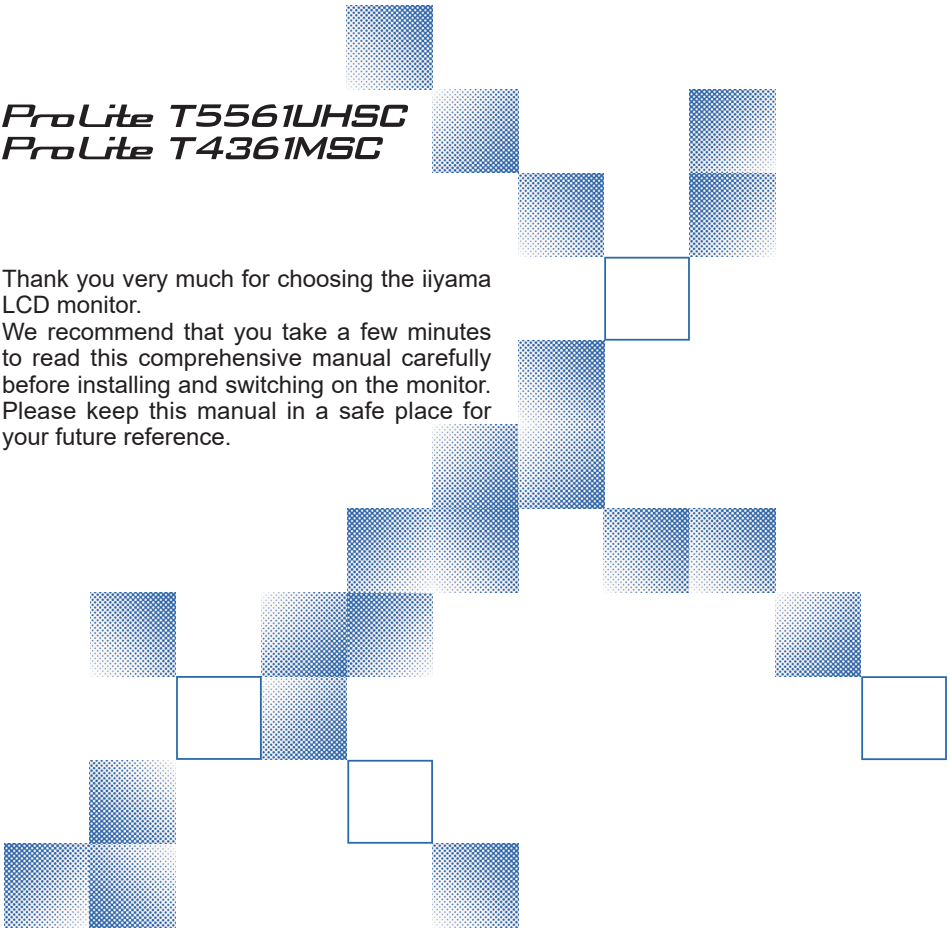

CE MARKING DECLARATION OF CONFORMITY

This LCD monitor complies with the requirements of the EC/EU Directive 2014/30/EU "EMC Directive", 2014/35/EU "Low Voltage Directive" and 2011/65/EU "RoHS Directive".

Warning

This is a class A product. In a domestic environment this product may cause radio interference in which case the user may be required to take adequate measures.

IYAMA CORPORATION: Wijkmeerstraat 8, 2131 HA Hoofddorp, The Netherlands

Model No. : PLT5561M / PLT4361M



We recommend recycling of used product. Please contact your dealer or iiyama service center. Recycle information is obtained via the Internet, using the address: <http://www.iiyama.com>

You can access the Web page of different countries from there.

- We reserve the right to change specifications without notice.
- All trademarks used in this user manual are the property of their respective owners.

TABLE OF CONTENTS

FOR YOUR SAFETY.....	1
SAFETY PRECAUTIONS.....	1
SPECIAL NOTES ON LCD MONITORS	3
CUSTOMER SERVICE	5
CLEANING	5
BEFORE YOU OPERATE THE MONITOR.....	6
FEATURES.....	6
CHECKING THE CONTENTS OF THE PACKAGE	6
SPECIAL NOTES ON THE TOUCH PANEL	7
INSTALLATION	8
CONTROLS AND CONNECTORS : MONITOR.....	9
CONNECTING YOUR MONITOR : ProLite T5561UHSC	12
CONNECTING YOUR MONITOR : ProLite T4361MSC	13
FITTING AND REMOVAL OF CABLE COVER	14
COMPUTER SETTING	15
OPERATING THE MONITOR.....	17
ADJUSTMENT MENU CONTENTS.....	19
SCREEN ADJUSTMENTS	24
POWER MANAGEMENT FEATURE.....	27
TROUBLE SHOOTING	28
RECYCLING INFORMATION.....	29
APPENDIX	30
SPECIFICATIONS : ProLite T5561UHSC	30
SPECIFICATIONS : ProLite T4361MSC	31
DIMENSIONS : ProLite T5561UHSC	32
DIMENSIONS : ProLite T4361MSC	32
COMPLIANT TIMING	33

FOR YOUR SAFETY

SAFETY PRECAUTIONS

WARNING

STOP OPERATING THE MONITOR WHEN YOU SENSE TROUBLE

If you notice any abnormal phenomena such as smoke, strange sounds or fumes, unplug the monitor and contact your dealer or iiyama service center immediately. Further use may be dangerous and can cause fire or electric shock.

NEVER REMOVE THE CABINET

High voltage circuits are inside the monitor. Removing the cabinet may expose you to the danger of fire or electric shock.

DO NOT PUT ANY OBJECT INTO THE MONITOR

Do not put any solid objects or liquids such as water into the monitor. In case of an accident, unplug your monitor immediately and contact your dealer or iiyama service center. Using the monitor with any object inside may cause fire, electric shock or damage.

INSTALL THE MONITOR ON A FLAT, STABLE SURFACE

The monitor may cause an injury if it falls or is dropped.

DO NOT USE THE MONITOR NEAR WATER

Do not use where water may be splashed or spilt onto the monitor as it may cause fire or electric shock.

OPERATE UNDER THE SPECIFIED POWER SUPPLY

Be sure to operate the monitor only with the specified power supply. Use of an incorrect voltage will cause malfunction and may cause fire or electric shock.

PROTECT THE CABLES

Do not pull or bend the power cable and signal cable. Do not place the monitor or any other heavy objects on the cables. If damaged, the cables may cause fire or electric shock.

ADVERSE WEATHER CONDITIONS

It is advisable not to operate the monitor during a heavy thunder storm as the continual breaks in power may cause malfunction. It is also advised not to touch the plug in these circumstances as it may cause electric shock.

CAUTION

INSTALLATION LOCATION

Do not install the monitor where sudden temperature changes may occur, or in humid, dusty or smoky areas as it may cause fire, electric shock or damage. You should also avoid areas where the sun shines directly on the monitor.

DO NOT PLACE THE MONITOR IN A HAZARDOUS POSITION

The monitor may topple and cause injury if not suitably located. Please also ensure that you do not place any heavy objects on the monitor, and that all cables are routed such that children may not pull the cables and possibly cause injury.

MAINTAIN GOOD VENTILATION

Ventilation slots are provided to keep the monitor from overheating. Covering the slots may cause fire. To allow adequate air circulation, place the monitor at least 10 cm (or 4 inches) from any walls. Operating the monitor on its back, side, upside down or on a carpet or any other soft material may also cause damage.

DISCONNECT THE CABLES WHEN YOU MOVE THE MONITOR

When you move the monitor, turn off the power switch, unplug the monitor and be sure the signal cable is disconnected. If you do not disconnect them, it may cause fire or electric shock.

UNPLUG THE MONITOR

If the monitor is not in use for a long period of time it is recommended that it is left unplugged to avoid accidents.

HOLD THE PLUG WHEN DISCONNECTING

To disconnect the power cable or signal cable, always pull it by the plug. Never pull on the cable itself as this may cause fire or electric shock.

DO NOT TOUCH THE PLUG WITH WET HANDS

Pulling or inserting the plug with wet hands may cause electric shock.

WHEN YOU INSTALL THE MONITOR ON YOUR COMPUTER

Be sure the computer is strong enough to hold the weight of the monitor, otherwise, you may damage your computer.

OTHERS

ERGONOMIC RECOMMENDATIONS

To eliminate eye fatigue, do not operate the monitor against a bright background or in a dark room. For optimal viewing comfort, the monitor should be just below eye level and 40-60 cm (16-24 inches) away from your eyes. When using the monitor over a prolonged time, a ten minute break every hour is recommended as looking at the screen continuously can cause eye strain.

SPECIAL NOTES ON LCD MONITORS

- The following symptoms are normal with LCD monitors and do not indicate a problem.

NOTE

- When you first turn on the LCD monitor, the picture may not fit in the display area because of the type of computer that is used. In this case, adjust the picture position to the correct position.
 - You may find slightly uneven brightness on the screen depending on the desktop pattern you use.
 - Due to the nature of the LCD screen, an afterimage of the previous screen may remain after switching the image, when the same image is displayed for hours. In this case, the screen is recovered slowly by changing the image or turning off the Power Switch for hours.
- This LCD cannot be used outdoors.
 - If you use a cable longer than the supplied one, the picture quality is not guaranteed. Touch function can be disrupted if the USB cable length exceeds 3m.

USAGE CONFIRMATION

This product is designed for optimum usage at 24hours per day.
The display is compatible for usage in Landscape/Portrait applications.

IMAGE PERSISTENCE / IMAGE STICKING

Please be aware that all LCD screens can experience Image Persistence or Image Sticking. This occurs when a residual image remains visible on a screen when static images are displayed for long periods of time. LCD Image Persistence is not permanent but constant images being displayed for a long period of time should be avoided.

To counteract Image Persistence, turn off the monitor for as long as the previous image was displayed, so if an image was on the monitor for 1 hour and there is evidence of a residual or “ghost” image, you should turn off the monitor for 1 hour in order to clear the residual image.

For all LFD products, iiyama recommends displaying moving images and utilising a moving screen saver at regular intervals whenever the screen is idle. You could also turn off the monitor when not in use to assist the prevention.

Other ways to reduce the risk of Image Persistence will be to utilise the FAN-on function (if available), Low Backlight and Low Brightness settings.

FOR EXTENDED USE AS A PUBLIC DISPLAY

■ Image Sticking on LCD Panel

When a static image is displayed for hours, an electric charge trace remains near the electrode inside the LCD producing a “ghost” image. (Image Persistence).

Image Persistence is not a permanent feature.

■ Recommendations

To prevent Image Sticking and promote longer life expectancy of display, we recommend the following:

1. Avoid static images displayed for long periods – change static images on continuous loop.
2. Turn off monitor when not in use, either by remote control or use Power Management or Schedule functions.
3. When monitor is installed in high ambient temperature environment(s) or in an enclosed position, utilise the Cooling Fan, Screen Saver and Low Brightness functions.
4. Suitable ventilation for any monitor is an expectation of any installation – climate control systems may need to be employed.
5. We strongly recommend utilisation of active cooling with fans for long operation times or high ambient temperature environments.

CUSTOMER SERVICE

NOTE

- If you have to return your unit for service and the original packaging has been discarded, please contact your dealer or iiyama service center for advice or replacement packaging.

CLEANING

WARNING

- If you drop any materials or liquids such as water into the monitor when cleaning, unplug the power cable immediately and contact your dealer or iiyama service center.

NOTE

- To protect the Touch screen surface, do not scratch or rub the screen with a hard object.
- Never use any of the following strong solvents. These will damage the cabinet and the Touch screen surface.
Abrasive cleaner Wax Solvent
- Touching the cabinet with any product made from rubber or plastic for a long time may cause degeneration or loss of paint on the cabinet.

CABINET

Stains can be removed with a cloth lightly moistened with a mild detergent solvent. Then wipe the cabinet with a soft dry cloth.

TOUCH SCREEN

Touch screen surface may be cleaned using a soft clean cloth moistened with mild window glass commercial cleaners or 50/50 mixture of water and IPA(ISO-propyl-alcohol). Don't use acid or alkaline solvent to clean the surface of the panel (or screen).

BEFORE YOU OPERATE THE MONITOR

FEATURES

- ◆ Supports Resolutions up to 3840 × 2160 : ProLite T5561UHSC
- ◆ Supports Resolutions up to 1920 × 1080 : ProLite T4361MSC
- ◆ High Contrast 1100:1 (Typical) / Brightness 450cd/m² (Typical: without Touch panel) : ProLite T5561UHSC
- ◆ High Contrast 4000:1 (Typical) / Brightness 400cd/m² (Typical: without Touch panel) : ProLite T4361MSC
- ◆ Digital Character Smoothing
- ◆ Automatic Set-up
- ◆ Stereo Speakers
2 × 8W Stereo Speakers
- ◆ Power Management (VESA DPMS Compliant)
- ◆ VESA Mounting Standard (400mm×400mm) Compliant
- ◆ IP65 Standard Compliant (Only front face)
- ◆ Anti fingerprint finish

CHECKING THE CONTENTS OF THE PACKAGE

The following accessories are included in your package. Check to see if they are enclosed with the monitor. If anything is missing or damaged, please contact your local iiyama dealer or regional iiyama office.

- | | | |
|-----------------------------|---------------------------------|---------------------------|
| ■ Power Cable* ¹ | ■ DVI-I-VGA Cable* ² | ■ VGA Cable* ³ |
| ■ HDMI Cable | ■ USB Cable | ■ Audio Cable |
| ■ Safety Guide | ■ Quick Start Guide | |

CAUTION

*¹ The rating of the Power Cable enclosed in 120V area is 10A/125V. If you are using a power supply higher than this rating, then a power cable with a rating of 10A/250V must be used. However, all guarantees and warranties are void for any problems or damage caused by a power cable not supplied by iiyama.

An approved power cable greater or equal to H05VVf, 3G, 0.75mm² must be used.

*² Accessory for ProLite T5561UHSC.

*³ Accessory for ProLite T4361MSC.

SPECIAL NOTES ON THE TOUCH PANEL

CAUTION

Permanent damage can occur if Sharp Edged, Pointed or Metal items are used to activate Touch. This could invalidate any remaining warranty. We recommend you use a stylus (tip R0.8 or over) or finger.

INSTALLATION

CAUTION

- Follow the manual instructions for the type of mount you have selected. Refer all servicing to qualified service personnel.
- Moving the monitor requires at least two people.
- Before installing, please make sure the wall is strong enough to hold the necessary weight of the display and the mount.

[WALL MOUNTING]

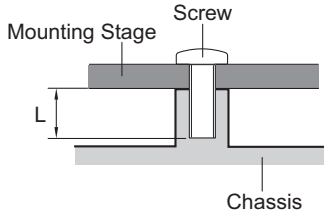

CAUTION

When using the wall mounting, consideration of thickness of the mounting stage needs to be taken. Tighten the M6 Screw with washer which "L" length is 20mm to fasten the monitor. Using a screw longer than this may cause electric shock or damage because it may contact with the electrical parts inside the monitor.

[ROTATING THE DISPLAY]

It is designed to be compatible in both landscape and portrait modes.

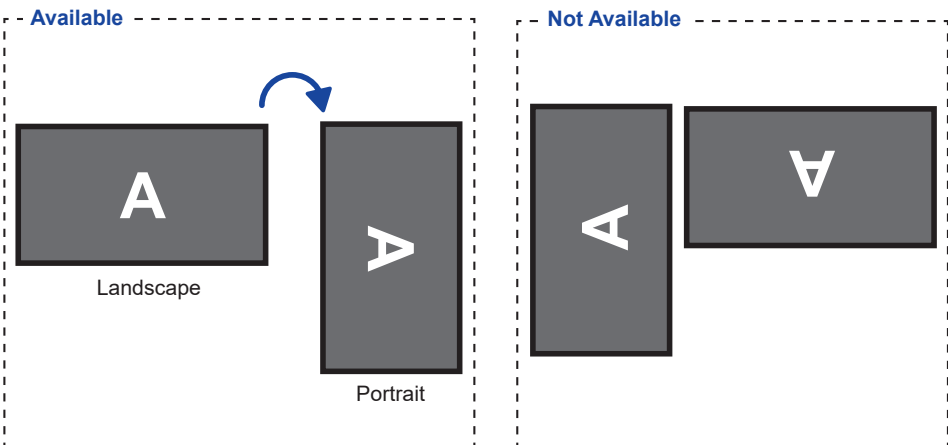

CONTROLS AND CONNECTORS : MONITOR

<Front>

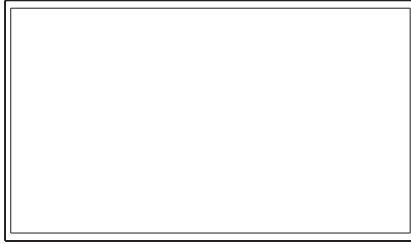

● ProLite T5561UHSC

ENGLISH

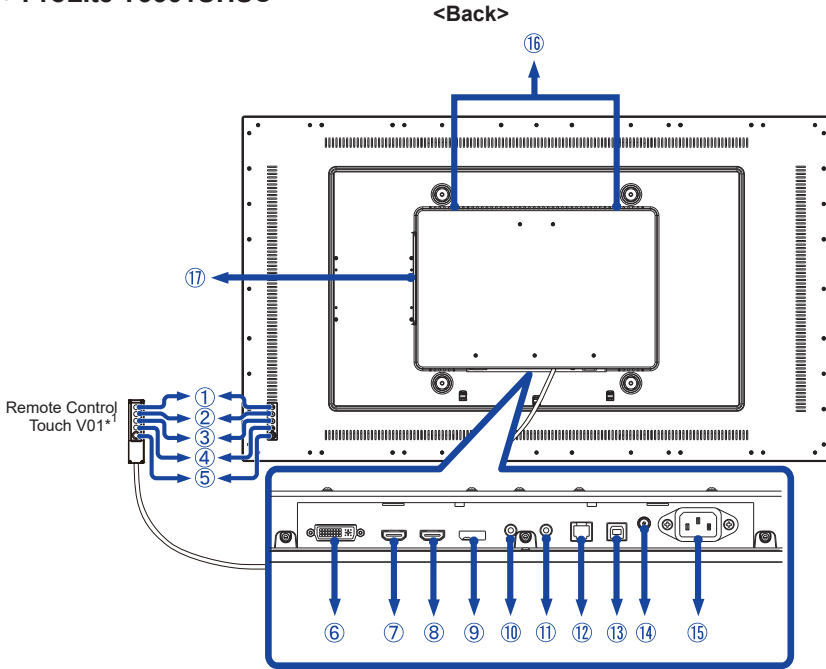

①	MENU		Menu Button
②	△		Scroll Up / Brightness Button
③	▽		Scroll Down / Mute Button
④	SELECT		Select / Auto Button
⑤	⏻		Power Button
⑥	DVI	DVI-I	DVI-I Connector
⑦	HDMI2	HDMI	HDMI Connector
⑧	HDMI1	HDMI	HDMI Connector
⑨	DP	DisplayPort	DisplayPort Connector
⑩	AUDIO-IN	Mini Jack	Audio Connector
⑪	AUDIO-OUT	Mini Jack	Audio Connector
⑫	RJ11* ¹	RJ11	Remote Control Touch V01 Connector
⑬	USB	USB Touch	USB Connector
⑭	DC-OUT* ²	DC jack	DC out connector(--- : Direct current) (DC-OUT)
⑮	AC-IN	AC-INLET	AC Connector(~ : Alternating current) (AC-IN)
⑯	SPEAKERS		Speakers
⑰	Option SDM slot* ³		Option SDM slot

*¹ Remote Control Touch V01 is optional.

*² DC-OUT may be unusable in some cases. Be sure to ask our service team for advice when you use DC-OUT.

*³ Please contact the iiyama Support Centre in your country if you wish to use Option SDM.

● ProLite T4361MSC

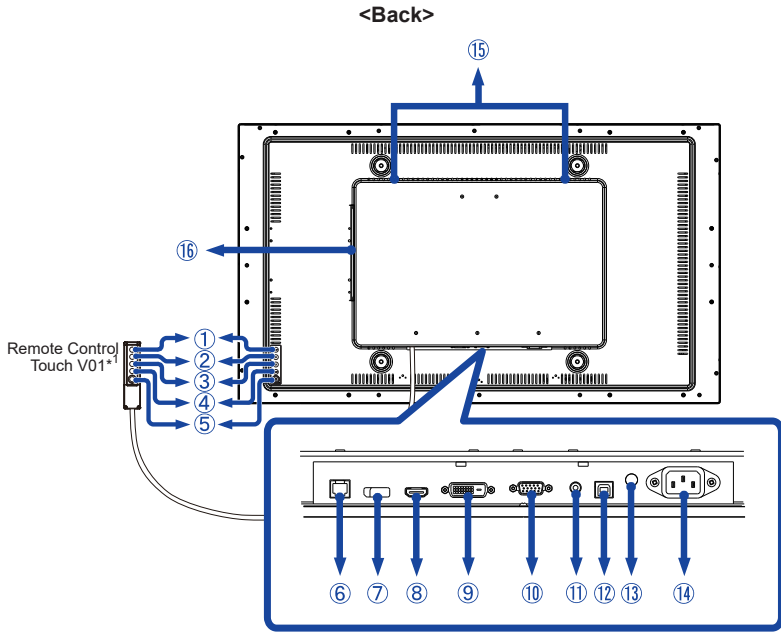

①	MENU		Menu Button
②	△		Scroll Up / Brightness Button
③	▽		Scroll Down / Mute Button
④	SELECT		Select / Auto Button
⑤	⏻		Power Button
⑥	RJ11* ¹	RJ11	Remote Control Touch V01 Connector
⑦	DP	DisplayPort	DisplayPort Connector
⑧	HDMI	HDMI	HDMI Connector
⑨	DVI	DVI-D	DVI-D Connector
⑩	VGA	VGA	VGA Connector
⑪	AUDIO-IN	Mini Jack	Audio Connector
⑫	USB	USB Touch	USB Connector
⑬	DC-OUT* ²	DC jack	DC out connector(⎓ : Direct current) (DC-OUT)
⑭	AC-IN	AC-INLET	AC Connector(⎓ : Alternating current) (AC-IN)
⑮	SPEAKERS		Speakers
⑯	Option SDM slot* ³		Option SDM slot

*¹ Remote Control Touch V01 is optional.

*² DC-OUT may be unusable in some cases. Be sure to ask our service team for advice when you use DC-OUT.

*³ Please contact the iiyama Support Centre in your country if you wish to use Option SDM.

CONNECTING YOUR MONITOR : ProLite T5561UHSC

- ① Ensure that both the computer and the monitor are switched off.
- ② Connect the computer to the monitor with the signal cable.
- ③ Connect the computer to the monitor with the USB Cable.
- ④ Connect the monitor to the audio equipment with the Audio Cable for computer when using the audio features.
- ⑤ Connect the monitor cable to the Remote Control Touch V01 (option), if necessary.
- ⑥ Connect the Power Cable to the monitor first and then to the power source.
- ⑦ Turn on your monitor and computer.

NOTE

- The signal cables used for connecting the computer and monitor may vary with the type of computer used. An incorrect connection may cause serious damage to both the monitor and the computer. The cable supplied with the monitor is for a standard connector. If a special cable is required please contact your local iiyama dealer or regional iiyama office.
- For connection to Macintosh computers, contact your local iiyama dealer or regional iiyama office for a suitable adaptor.
- Make sure you tighten the finger screws at each end of the Signal Cable.
- When USB cable connected than wait for 8 seconds and the touch function is ready to go. It can be activated by pen, finger or any other pointer.
- The Class I pluggable equipment Type A must be connected to protective earth.
- The socket-outlet shall be installed near the equipment and shall be easily accessible.
- Excessive sound pressure from ear-/headphones can cause hearing damage/hearing loss.

[Example of Connection]

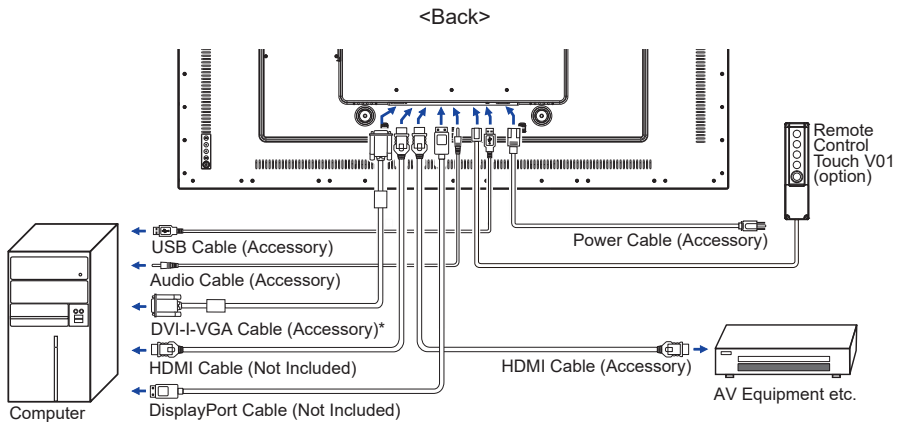

* DVI-D cable is not supplied with the monitor. If you use low quality DVI-D cable, it may cause a result of electro-magnetic interference. Please contact the iiyama Support Centre in your country if you wish to connect the monitor via the DVI-D input.

CONNECTING YOUR MONITOR : ProLite T4361MSC

- ① Ensure that both the computer and the monitor are switched off.
- ② Connect the computer to the monitor with the signal cable.
- ③ Connect the computer to the monitor with the USB Cable.
- ④ Connect the monitor to the audio equipment with the Audio Cable for computer when using the audio features.
- ⑤ Connect the monitor cable to the Remote Control Touch V01 (option), if necessary.
- ⑥ Connect the Power Cable to the monitor first and then to the power source.
- ⑦ Turn on your monitor and computer.

NOTE

- The signal cables used for connecting the computer and monitor may vary with the type of computer used. An incorrect connection may cause serious damage to both the monitor and the computer. The cable supplied with the monitor is for a standard connector. If a special cable is required please contact your local iiyama dealer or regional iiyama office.
- For connection to Macintosh computers, contact your local iiyama dealer or regional iiyama office for a suitable adaptor.
- Make sure you tighten the finger screws at each end of the Signal Cable.
- When USB cable connected then wait for 8 seconds and the touch function is ready to go. It can be activated by pen, finger or any other pointer.
- The Class I pluggable equipment Type A must be connected to protective earth.
- The socket-outlet shall be installed near the equipment and shall be easily accessible.

[Example of Connection]

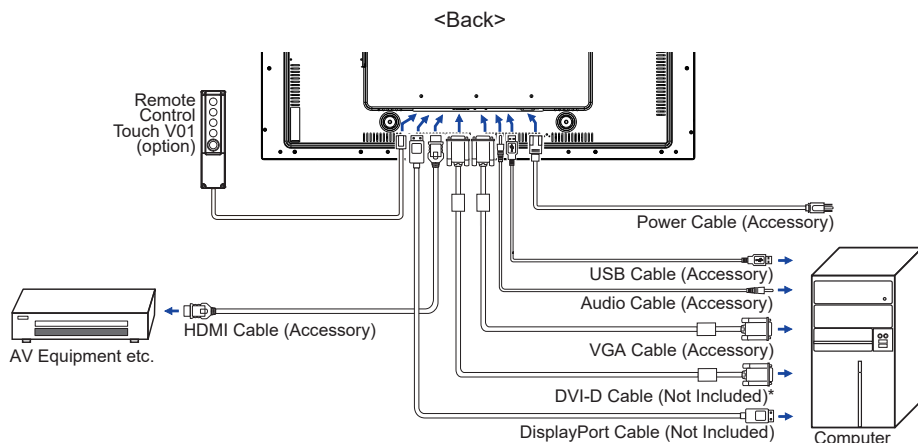

* DVI-D cable is not supplied with the monitor. If you use low quality DVI-D cable, it may cause a result of electro-magnetic interference. Please contact the iiyama Support Centre in your country if you wish to connect the monitor via the DVI input.

FITTING AND REMOVAL OF CABLE COVER

Put a piece of soft cloth on the table beforehand to prevent the monitor from being scratched. Lay the monitor flat on a table with front face down.

< Removal >

Remove the screw of the cable cover and remove the cable cover from the monitor as shown in Step 1.

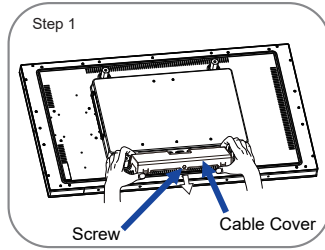

< Fitting >

When cables are connected as shown in Step 2-1, Step 2-2 or Step 2-3, place the cable cover and fix it firmly using a screw.

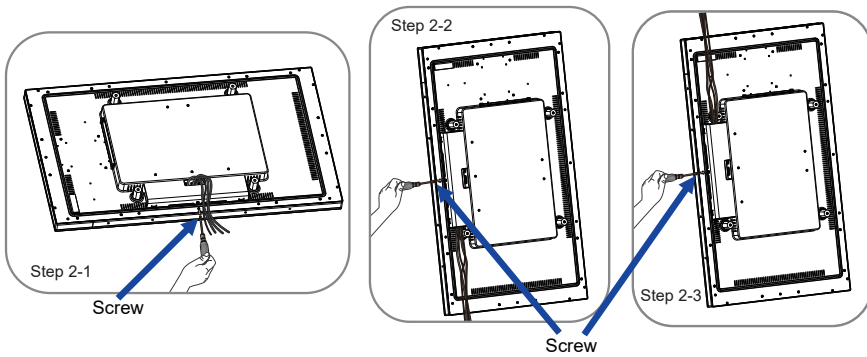

COMPUTER SETTING

■ Signal Timing

Change to the desired signal timing listed on page 33: COMPLIANT TIMING.

■ Windows XP/Vista/7/8/8.1/10 Plug & Play

The iiyama LCD monitor complies with DDC2B of VESA standard. The Plug & Play function runs on Windows XP/Vista/7/8/8.1/10 by connecting the monitor to DDC2B compliant computer with the Signal Cable supplied.

For installation on Windows XP: The monitor Information File for iiyama monitors may be necessary for your computer and obtained via the Internet, using the address:

<http://www.iiyama.com>

NOTE

- For additional information on how to download the driver for your touch screen monitor, please access the internet site noted above.
- Monitor Drivers are not required in most cases for Macintosh or Unix operating systems. For further information, please contact your computer dealer first for advice.

■ Procedure for turning ON the Power Switch

Turn ON the monitor first, and then the computer.

■ MULTI-TOUCH :

This monitor complies with DDC2B of VESA standard. (Plug&play compliant)

The MULTI-TOUCH function runs on Windows7/8/8.1/10 by connecting the monitor to DDC2B compliant computer with the USB cable supplied.

■ TOUCH support operation system :

OS Version (Windows)	Windows			
	Win 10	Win8/8.1	Win7	XP
Supported touches	multi-touch			
Note	Windows inbox driver (No Need SiS driver)			Single-touch

OS Version (Linux Distribution)	Android				Linux
	7.0	6.0	5.0 ~ 5.1	4.0 ~ 4.4	
Supported touches	multi-touch				
Supported Kernel version	4.4	3.18	3.0~3.14		3.0~4.4
Note	Driver supports multi-touch				

OS Version (Mac OS)	Mac OS			
	10.9 (Mavericks)	10.10 (Yosemite)	10.11 (El Capitan)	10.12 (Sierra) 10.13 (High Sierra)
Supported touches	Single-touch			
Note	Similar to Apple Trackpad gesture: 2-finger gesture: zoom in/out, swipe 4-finger gesture: show desktop	Similar to Apple Trackpad gesture: 2-finger gesture: zoom in/out, swipe 4-finger gesture: show desktop Our service team provides you with the driver and the operation guide.	Similar to Apple Trackpad gesture: 2-finger gesture: zoom in/out, swipe 4-finger gesture: show desktop Our service team provides you with the driver and the operation guide.	Our service team provides you with the driver and the operation guide.

OPERATING THE MONITOR

To create the best picture, your iiyama LCD monitor has been preset at the factory with the COMPLIANT TIMING shown on page 33. You are also able to adjust the picture by following the button operation shown below. For more detailed adjustments, see page 24 for SCREEN ADJUSTMENTS.

- ① Press the MENU Button to start the On Screen Display feature. There are additional Menu items which can be switched by using the Δ / ∇ Buttons.

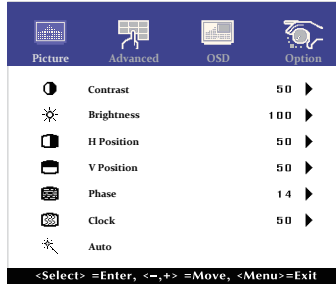

- ② Select the Menu item which contains the adjustment icon relating to the adjustment you want to make. Use the SELECT Button to highlight the desired adjustment icon.
- ③ Use the Δ / ∇ Buttons to make the appropriate adjustment or setting.
- ④ Press the MENU Button to leave the menu, and the settings you just made would be automatically saved.

For example, to correct for vertical position, select Menu item of Picture. Then, select V Position by using the SELECT Button.

Use the Δ / ∇ Buttons to change the vertical position settings. The vertical position of the overall display should be changing accordingly while you are doing this.

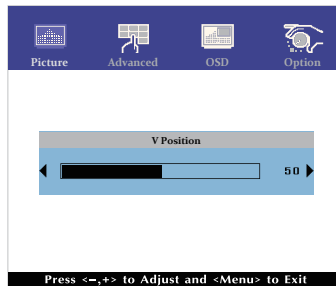

Press the MENU Button lastly, it ends, all changes are saved in the memory.

NOTE

- When button operations are aborted during adjustment, On-Screen Display disappears when the time set for the OSD Timeout has passed.
- MENU button can be used to return previous menu item.
- Any changes are automatically saved in the memory when the On Screen Display disappears. Turning off the power should be avoided while using the Menu.
- Adjustments for H/V Position, Clock and Phase are saved for each signal timing. Except for these adjustments, all other adjustments have only one setting which applies to all signal timings.

Direct

- LOCK MODE:

Simultaneously press the MENU button and the ▽ button when an image is displayed through VGA, DVI, HDMI, DisplayPort or SDM.

* The OSD menu is not displayed when the OSD is locked. Press the MENU button and the ▽ button simultaneously again.

The following OSD menu is displayed.

Adjustment Item	Problem / Option	
POWER	Active	The POWER SWITCH is Locked.
	Inactive	The POWER SWITCH is Unlocked.
OSD	Active	The OSD menu is Locked.
	Inactive	The OSD menu is Unlocked.

ENGLISH

- TOUCH FUNCTION DISABLE:

ON: Pressing and holding of the MENU Button and the SELECT Button at the same time when the Menu is not displayed, message "TOUCH DISABLE" will appear on the top right corner.

OFF: Pressing and holding of the MENU Button and the SELECT Button at the same time for about 5 seconds when the Menu is not displayed, till "TOUCH DISABLE" disappears.

<Touch OSD function>

When the Touch function is active, you can operate the OSD menu by touching it with your finger.

To exit the OSD after saving the settings or adjustments, touch the screen other than on the OSD.

* To display the OSD menu, press the MENU button.

ADJUSTMENT MENU CONTENTS

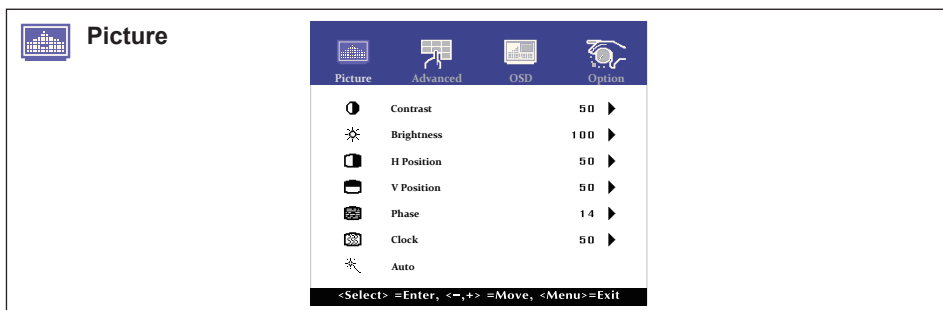

Adjustment Item	Problem / Option	Button to Press
Contrast Direct	Too dull Too intense	
Brightness* ¹ Direct	Too dark Too bright	
H Position* ⁴	Too left Too right	
V Position* ⁴	Too low Too high	
Phase* ^{2,4}	To correct flickering text or lines	
Clock* ^{2,4}	Too narrow Too wide	
Auto* ^{3,4}	Adjust H/V Position, Clock and Phase automatically.	

*¹ Adjust the Brightness when you are using the monitor in a dark room and feel the screen is too bright.

*² See page 24 for SCREEN ADJUSTMENTS.











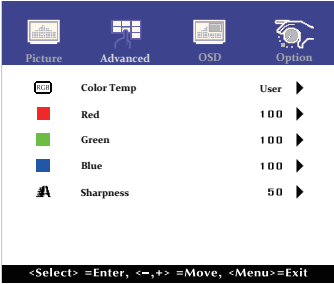











*³ For best results, use the Auto Adjust in conjunction with the adjustment pattern. See page 24 for SCREEN ADJUSTMENTS.

*⁴ Only Analog Input.

Direct

You can skip the Menu items and directly display an adjustment scale by using the following button operations.

- Contrast: Press the Button when the Menu is not displayed.
- Brightness: Press the Button when the Menu is not displayed.

 Advanced											
											
Adjustment Item	Problem / Option Button to Press										
Color Temp	5500k										
	6500k										
	7500k										
	9300k										
	<table border="1" style="width: 100%;"> <tr> <td rowspan="3" style="width: 15%;">User</td> <td style="width: 15%;">Red</td> <td rowspan="3" style="width: 30%;">Too weak</td> <td style="width: 40%; text-align: right;"> </td> </tr> <tr> <td>Green</td> <td rowspan="2" style="text-align: right;"> </td> </tr> <tr> <td>Blue</td> </tr> <tr> <td colspan="2"></td> <td>Too strong</td> <td style="text-align: right;"> </td> </tr> </table>	User	Red	Too weak	 	Green	 	Blue			Too strong
User	Red		Too weak		 						
	Green				 						
	Blue										
		Too strong	 								
Sharpness	<p>You can change the picture quality from 0 to 100 (soft to sharp).  </p> <p>Press the  Button to change the picture quality in numerical order. Press the  Button to change the picture quality in reverse numerical order.  </p> <p>Adjust the picture quality at resolutions of less 1920 x 1080(ProLite T4361MSC) or 3840 x 2160(ProLite T5561UHSC). You can change the picture quality.</p>										



OSD

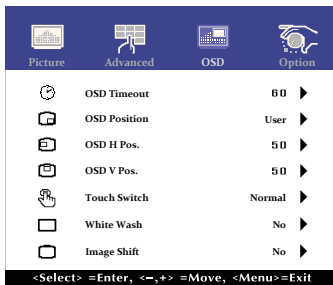

Adjustment Item	Problem / Option		Button to Press
OSD Timeout	You can set the OSD display duration time between 5 and 60 seconds.		
OSD Position	You can set the OSD position. User (Upper left / Lower left / Upper right / Lower right / Center)		
OSD H Pos.	OSD is too left		
	OSD is too right		
OSD V Pos.	OSD is too low		
	OSD is too high		
Touch Switch *	Normal	Normal touch (with bare hands or stylus device)	
	Glove	Touch with gloved hand (Supports thickness +2mm, 5pts touch)	
	Through-Glass	Touch through glass (Supports thickness +6mm, 2pts touch)	
White Wash	No	White Wash is turned off.	
	Yes	When the monitor will go into sleep mode, an all-white pattern will be displayed for 30 minutes.	
Image Shift	No	Image Shift is turned off.	
	Yes	To prevent burn-in as much as possible, an image will randomly move in 2 dots by the minute.	

* Please turn on the power and set the Touch Switch after the monitor installation is completed. Turning on the power and setting the Touch Switch before the monitor installation may cause misalignment or malfunction of the touch calibration.

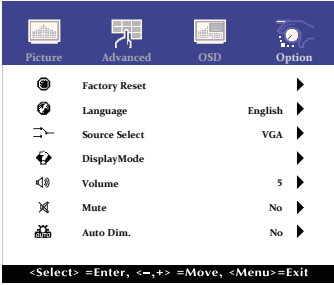
Adjustment Item		Problem / Option		Button to Press	
					
Reset	No	Return to Menu.			
	Yes	Factory-preset data is restored.			
Language	English	English	Español	Spanish	
	Français	French	日本語	Japanese	
	Deutsch	German	繁體中	Traditional Chinese	
	Italiano	Italian	簡中	Simplified Chinese	
	Auto	Search for an available input source and select automatically.			
Source Select For ProLite T5561UHSC	Auto	Search for an available input source and select automatically.			
	DVI-A* ¹	Select the analog(DVI-A) input.			
	DVI-D* ¹	Select the digital(DVI-D) input.			
	HDMI1* ¹	Select the digital(HDMI1) input.			
	HDMI2* ¹	Select the digital(HDMI2) input.			
	DP	Select the digital(DisplayPort) input.			
	SDM* ²	Select the SDM input.			
NOTE However it will automatically be selected when just one source is using. In Power Management Mode input switching is disabled. Input source is fixed, not selected automatically when DVI-A, DVI-D, HDMI1, HDMI2, DisplayPort and SDM which are selected.					
Source Select For ProLite T4361MSC	Auto	Search for an available input source and select automatically.			
	VGA* ³	Select the analog input.			
	DVI* ³	Select the digital(DVI) input.			
	HDMI* ³	Select the digital(HDMI) input.			
	DP	Select the digital(DisplayPort) input.			
	SDM* ²	Select the SDM input.			
NOTE However it will automatically be selected when just one source is using. In Power Management Mode input switching is disabled. Input source is fixed, not selected automatically when VGA, DVI, HDMI, DisplayPort and SDM which are selected.					

*¹ Available for ProLite T5561UHSC only.

*² SDM can only be used when Option SDM is installed.

*³ Available for ProLite T4361MSC only.

Direct

You can skip the Menu items and directly display an option setting screen by using the following button operations.

- Source Select : Pressing and holding of the SELECT Button for about 5 seconds when the Menu is not displayed. By pressing the SELECT Button during power management mode, the Source Select menu will be displayed.



Option

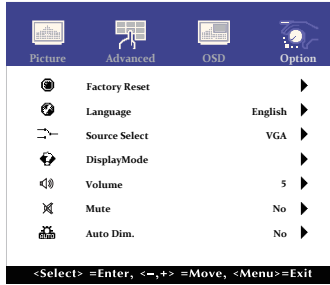

Adjustment Item	Problem / Option		Button to Press
Display Mode	Displays information regarding the current input signal coming from the graphic card in your computer. NOTE See your graphic card user guide for more information about changing the resolution and refresh.		
Volume	Too soft		
	Too loud		
Mute	No	Return the sound volume to the previous level.	
	Yes	Turn off the sound temporarily.	
Auto Dim.	No	Auto Dim. is turned off.	
	Yes	Automatically adjust image brightness to changing ambient lighting conditions.	

SCREEN ADJUSTMENTS

Adjust the image by following the procedure below to get the desired picture when selecting Analog input.

- The screen adjustments described in this manual are designed to set image position and minimize flicker or blur for the particular computer in use.
- **ProLite T5561UHSC** : The monitor is designed to provide the best performance at resolution of 3840 × 2160, but can not provide the best at resolutions of less than 3840 × 2160 because the picture is automatically stretched to fit the full screen. It is recommended to operate at resolution of 3840 × 2160 in normal use.
- **ProLite T4361MSC** : The monitor is designed to provide the best performance at resolution of 1920 × 1080, but can not provide the best at resolutions of less than 1920 × 1080 because the picture is automatically stretched to fit the full screen. It is recommended to operate at resolution of 1920 × 1080 in normal use.
- Displayed text or lines will be blurred or irregular in thickness when the picture is stretched due to the screen enlargement process.
- It is preferable to adjust the image position and frequency with the monitor controls, rather than the computer software or utilities.
- Perform adjustments after a warm-up period of at least thirty minutes.
- Additional adjustments may be required after the Auto Adjust depending on the resolution or signal timing.
- The Auto Adjust may not work correctly when displaying the picture other than the screen adjustment pattern. In this case, manual adjustments are required.

There are two ways to adjust the screen. One way is automatic adjustment for Position, Clock and Phase. The other way is performing each adjustment manually.

Perform the Auto Adjust first when the monitor is connected to a new computer, or resolution is changed. If the screen has a flicker or blur, or the picture does not fit in the display area after performing the Auto Adjust, manual adjustments are required. Both adjustments should be made by using the screen adjustment pattern (Test.bmp) obtained via the IYAMA web site (<http://www.iiyama.com>).

Adjust the image by following the procedure below to get the desired picture.

This manual explains adjustment under Windows® OS.

- ① **Display the picture at the optimum resolution.**
- ② **Enter the Test.bmp (screen adjustment pattern) to wallpaper.**

NOTE

- Consult the appropriate documentation for doing this.
- Set the display position to center in the wallpaper setting dialogue box.

[Adjustment pattern]

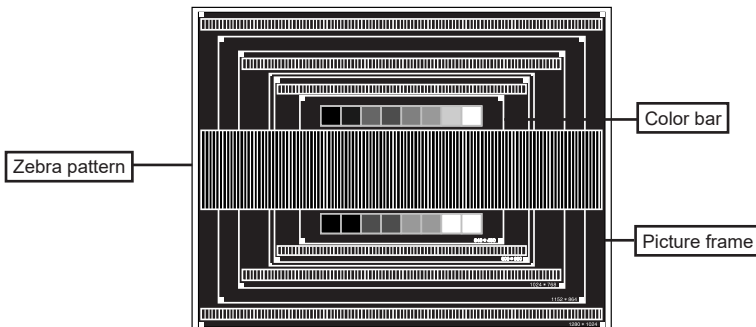

- ③ Adjust the Auto Adjustment.
- ④ Adjust the image manually by following procedure below when the screen has a flicker or blur, or the picture does not fit in the display area after performing the Auto Adjust.
- ⑤ Adjust the V Position so that the top and bottom of the picture frame will fit to the display area.

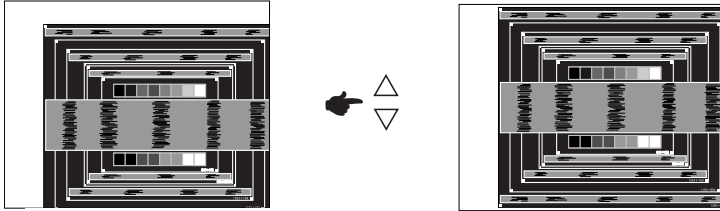

- ⑥ 1) Adjust the H Position so that the left side of the picture frame will move to the left edge of the display area.

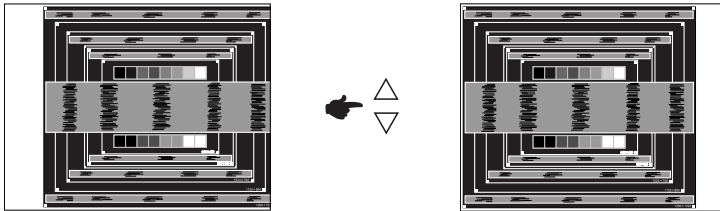

- 2) Stretch the right side of the picture frame to the right edge of the display area by adjusting the Clock.

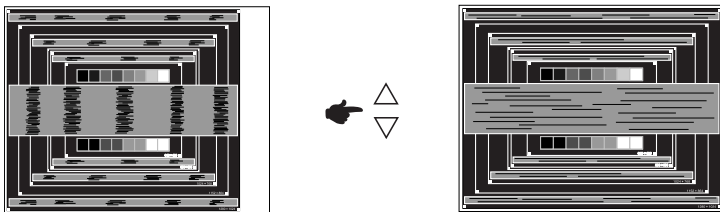
**NOTE**

- When the left side of the picture frame moves apart from the left edge of the display area during the Clock adjustment, adjust steps 1) and 2).
- Another way to make the Clock adjustment is to correct the vertical wavy lines in the zebra pattern.
- The picture may flicker during the Clock, H/V Position adjustment.
- In case the picture frame is bigger or smaller than the data display area after the Clock adjustment, repeat steps from ③.

- ⑦ Adjust the Phase to correct horizontal wavy noise, flicker or blur in the zebra pattern.

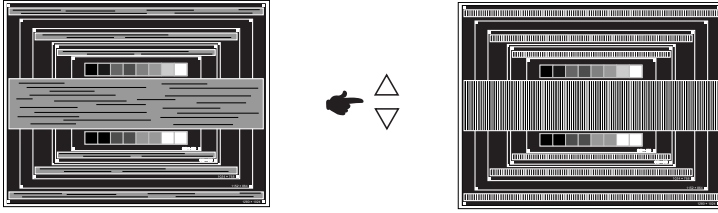
**NOTE**

- In case the strong flicker or blurs remain on a part of the screen, repeat steps ⑥ and ⑦ because the Clock may not be adjusted correctly. If the flicker or blurs still remain, set the refresh rate of computer to low (60Hz) and repeat steps from ③ again.
- Adjust the H Position after the Phase adjustment if the horizontal position moves during the adjustment.

- ⑧ Adjust the Brightness and Color to get the desired picture after you complete the Clock and Phase adjustments.

Put back your favorite wallpaper.

POWER MANAGEMENT FEATURE

The power management feature of this product complies with power saving requirement of VESA DPMS. When activated, it automatically reduces unnecessary power consumption of the monitor when your computer is not in use.

To use the feature, the monitor needs to be connected to a VESA DPMS compliant computer. There is a power management step the monitor takes as described below. The power management function, including any timer settings is configured by the operating system. Check your operating system manual for information on how this can be configured.

■ Power Management Mode

When the H-sync signal / V-sync signal / H and V sync signals from the computer are off, the monitor enters into Power Management Mode which reduces the power consumption to less than 2.0W. The screen becomes dark. From Power Management Mode, the image reappears in several seconds when either the keyboard or the mouse are touched again.

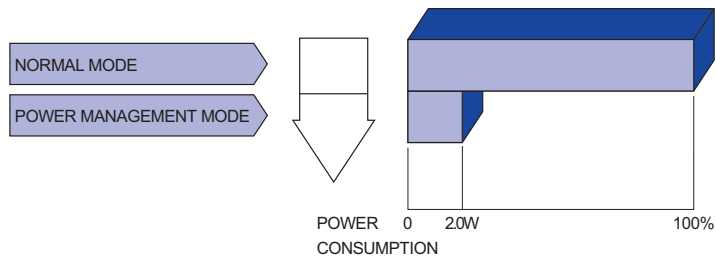

NOTE

- Even when using the power management mode, the monitor consumes electricity. Turn off the Power Switch whenever the monitor is not in use, during the night and weekends, to avoid unnecessary power consumption.
- It is possible that the video signal from the computer may be on while the H or V sync signal is missing. In this instance, the POWER MANAGEMENT feature may not work properly.

TROUBLE SHOOTING

If the monitor fails to operate correctly, please follow the steps below for a possible solution.

1. Perform the adjustments described in OPERATING THE MONITOR, depending on the problem you have. If the monitor does not get a picture, skip to 2.
2. Consult the following items if you cannot find an appropriate adjustment item in OPERATING THE MONITOR or if the problem persists.
3. If you are experiencing a problem which is not described below or you cannot correct the problem, discontinue using the monitor and contact your dealer or iiyama service center for further assistance.

Problem	Check
① The picture does not appear.	<input type="checkbox"/> The Power Cable is firmly seated in the socket. <input type="checkbox"/> The Power Switch is turned ON. <input type="checkbox"/> The AC socket is live. Please check with another piece of equipment. <input type="checkbox"/> If the blank screen saver is in active mode, touch the keyboard or the mouse. <input type="checkbox"/> Increase the Contrast and/or Brightness. <input type="checkbox"/> The computer is ON. <input type="checkbox"/> The Signal Cable is properly connected. <input type="checkbox"/> The signal timing of the computer is within the specification of the monitor. <input type="checkbox"/> If the monitor is in power management mode, touch the keyboard or the mouse.
② The screen is not synchronized.	<input type="checkbox"/> The Signal Cable is properly connected. <input type="checkbox"/> The signal timing of the computer is within the specification of the monitor. <input type="checkbox"/> The video output level of the computer is within the specification of the monitor.
③ The screen position is not in the center.	<input type="checkbox"/> The signal timing of the computer is within the specification of the monitor.
④ The screen is too bright or too dark.	<input type="checkbox"/> The video output level of the computer is within the specification of the monitor.
⑤ The screen is shaking.	<input type="checkbox"/> The power voltage is within the specification of the monitor. <input type="checkbox"/> The signal timing of the computer is within the specification of the monitor.
⑥ No sound.	<input type="checkbox"/> The audio equipment (computer etc.) is ON. <input type="checkbox"/> The Audio Cable is properly connected. <input type="checkbox"/> The Volume is turned up. <input type="checkbox"/> The Mute is OFF. <input type="checkbox"/> The audio output level of the audio equipment is within the specification of the monitor.
⑦ The sound is too loud or too quiet.	<input type="checkbox"/> The audio output level of the audio equipment is within the specification of the monitor.

Problem**Check**

- | | |
|--|---|
| ⑧ A strange noise is heard. | <input type="checkbox"/> The Audio Cable is properly connected. |
| ⑨ The touch screen shows no response. | <input type="checkbox"/> The USB Cable is firmly seated in the socket.
<input type="checkbox"/> Touch screen driver software is installed. |
| ⑩ The touch position does not deviate. | <input type="checkbox"/> The calibration function set up correctly. |

RECYCLING INFORMATION

For better environment protection please don't dispose your monitor.
Please visit our web site: www.iiyama.com for monitor recycling.

APPENDIX

Design and specifications are subject to change without prior notice.

SPECIFICATIONS : ProLite T5561UHSC

ENGLISH

Touch Screen	Technology	Projected capacitive 40 points max. (by normal mode)
	Light transmission	85%
	Hardness	6H
	Thickness	3mm
	Communication system	USB serial transfer
	Surface finish	Anti fingerprint coating
Size Category		55"
LCD Panel	Panel technology	IPS
	Size	Diagonal: 55" (140cm)
	Pixel pitch	0.315mm H × 0.315mm V
	Brightness	450cd/m ² (Typical: without Touch panel)
	Contrast ratio	1100 : 1 (Typical)
	Viewable angle	Horizontal : 178 degrees, Vertical: 178 degrees (Typical)
	Response time	6ms (Gray to Gray)
Display Colors		Approx.16.7M
Sync Frequency		DVI-A/D: Horizontal: 30.0-81.0kHz, Vertical: 30-60Hz HDMI1/DisplayPort: Horizontal: 30.0-135.0kHz, Vertical: 30-60Hz HDMI2: Horizontal: 30.0-135.0kHz, Vertical: 30-60Hz
Native Resolution		3840 × 2160, 8.2 MegaPixels
Supported max. resolution		DVI-A/D: 1920 × 1200 60Hz HDMI2: 3840 × 2160 30Hz HDMI1/DisplayPort: 3840 × 2160 60Hz
Input Connector		DVI-I, HDMI × 2, DisplayPort
Input Audio Connector		ø 3.5mm mini jack (Stereo)
Input Audio Signal		2Vrms maximum
Plug & Play		VESA DDC2B™
Input Sync Signal		Separate sync: TTL, Positive or Negative
Input Video Signal		Analog: 0.7Vp-p (Standard), 75Ω, Positive Digital: DVI (Digital Visual Interface Standard Rev.1.0) compliance Digital: HDMI, DisplayPort
Output Audio Connector		ø 3.5mm mini jack (Stereo)
Speakers		8W×2 (Stereo speakers)
Maximum Screen Size		1209.6mm W × 680.4mm H / 47.6" W × 26.8" H
Power Source		Input: 100-240VAC, 50-60Hz, 1.8-0.8A Output: 5VDC, 2.0A
Power Consumption*		110W typical, Power management mode: 2.0W maximum Energy Efficiency Class: C
Dimensions / Net Weight		1247.5 × 732.5 × 81.0mm / 49.1 × 28.8 × 3.2" (W×H×D) 30.7kg / 67.8lbs
Environmental Considerations		Operating: Temperature 0 to 40°C / 32 to 104°F Humidity 90% (No condensation) Storage: Temperature -20 to 60°C / 4 to 140°F Humidity 90% (No condensation)
Approvals		CB, CE, EAC

NOTE * USB peripherals / Audio equipment are not connected.

SPECIFICATIONS : ProLite T4361MSC

Touch Screen	Technology	Projected capacitive 40 points max. (by normal mode)
	Light transmission	84%
	Hardness	7H
	Thickness	3mm
	Communication system	USB serial transfer
	Surface finish	Anti fingerprint coating
Size Category		43"
LCD Panel	Panel technology	MVA
	Size	Diagonal: 43" (108cm)
	Pixel pitch	0.49mm H × 0.49mm V
	Brightness	400cd/m ² (Typical: without Touch panel)
	Contrast ratio	4000 : 1 (Typical)
	Viewable angle	Horizontal : 178 degrees, Vertical: 178 degrees (Typical)
	Response time	8ms (Gray to Gray)
Display Colors		Approx. 16.7M
Sync Frequency		VGA: Horizontal: 30.0-73.0kHz, Vertical: 47-63Hz DVI/HDMI/DisplayPort: Horizontal: 30.0-73.0kHz, Vertical: 47-63Hz
Native Resolution		1920 × 1080, 2.1 MegaPixels
Supported max. resolution		VGA: 1920 × 1080 60Hz DVI/HDMI/DisplayPort: 1920 × 1080 60Hz
Input Connector		VGA, DVI-D, HDMI, DisplayPort
Input Audio Connector		ø 3.5mm mini jack (Stereo)
Input Audio Signal		2Vrms maximum
Plug & Play		VESA DDC2B™
Input Sync Signal		Separate sync: TTL, Positive or Negative
Input Video Signal		Analog: 0.7Vp-p (Standard), 75Ω, Positive Digital: DVI (Digital Visual Interface Standard Rev.1.0) compliance Digital: HDMI, DisplayPort
Speakers		8W×2 (Stereo speakers)
Maximum Screen Size		940.86mm W × 529.25mm H / 37.0" W × 20.8" H
Power Source		Input: 100-240VAC, 50-60Hz, 1.4-0.6A Output: 5VDC, 2.0A
Power Consumption*		65W typical, Power management mode: 2.0W maximum Energy Efficiency Class: B
Dimensions / Net Weight		983.0 × 571.5 × 82.5mm / 38.7 × 22.5 × 3.2" (W×H×D) 19.5kg / 43.0lbs
Environmental Considerations		Operating: Temperature 0 to 40°C / 32 to 104°F Humidity 90% (No condensation) Storage: Temperature -20 to 60°C / 4 to 140°F Humidity 90% (No condensation)
Approvals		CB, CE, EAC, cULus, CCC

NOTE * USB peripherals / Audio equipment are not connected.

DIMENSIONS : ProLite T5561UHSC

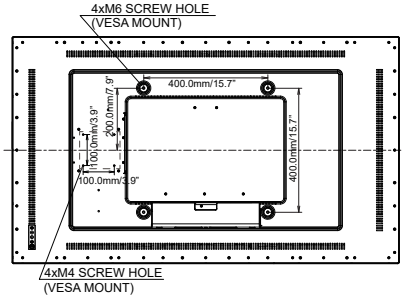
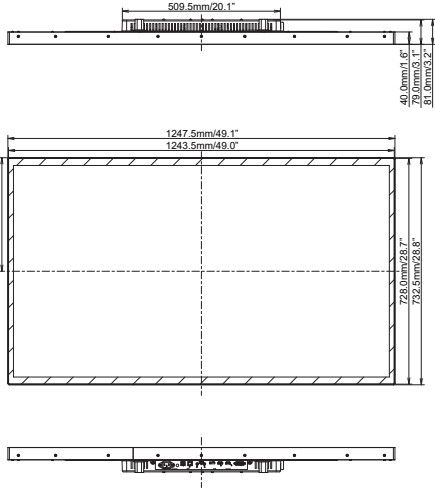

DIMENSIONS : ProLite T4361MSC

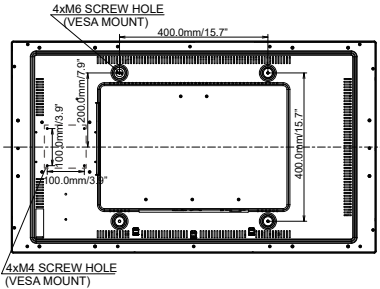
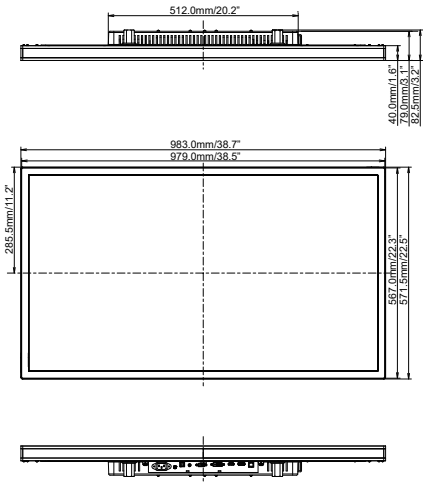

COMPLIANT TIMING

Video Mode		Horizontal Frequency	Vertical Frequency	Dot Clock		
VESA	VGA	640 × 480	31.469kHz	59.940Hz	25.175MHz	
	SVGA	800 × 600	37.879kHz	60.317Hz	40.000MHz	
	XGA	1024 × 768	48.363kHz	60.004Hz	65.000MHz	
		1280 × 720	44.720kHz	60.000Hz	74.500MHz	
	SXGA	1280 × 1024	63.981kHz	60.020Hz	108.000MHz	
	WSXGA+	1680 × 1050	65.290kHz	59.954Hz	146.250MHz	
	Full HD	1920 × 1080	67.500kHz	60.000Hz	148.500MHz	
	WUXGA	1920 × 1200	74.038kHz	59.950Hz	154.000MHz	*1
	UHD	3840 × 2160 30Hz	67.430kHz	29.970Hz	296.700MHz	*1,2
3840 × 2160 60Hz		133.313kHz	59.997Hz	533.250MHz	*1,3	

NOTE *1 Available for ProLite T5561UHSC only.

*2 HDMI2 input only.

*3 HDMI1/DisplayPort input only.