

Acer LCD Monitor

User's Guide

Copyright © 2019. Acer Incorporated.
All Rights Reserved.

Acer LCD Monitor User's Guide
Original Issue: 8/2019

Changes may be made periodically to the information in this publication without obligation to notify any person of such revisions or changes. Such changes will be incorporated in new editions of this manual or supplementary documents and publications. This company makes no representations or warranties, either expressed or implied, with respect to the contents hereof and specifically disclaims the implied warranties of merchantability or fitness for a particular purpose.

Record the model number, serial number, purchase date and place of purchase information in the space provided below. The serial number and model number are recorded on the label affixed to your computer. All correspondence concerning your unit should include the serial number, model number and purchase information.

No part of this publication may be reproduced, stored in a retrieval system, or transmitted, in any form or by any means, electronically, mechanically, by photocopy, recording or otherwise, without the prior written permission of Acer Incorporated.

Acer LCD Monitor User's Guide

Model number: _____

Serial number: _____

Date of purchase: _____

Place of purchase: _____

Acer and the Acer logo are registered trademarks of Acer Incorporated. Other companies' product names or trademarks are used herein for identification purposes only and belong to their respective companies.

Special notes on LCD monitors

The following are normal with the LCD monitor and do not indicate a problem.

- Due to the nature of the fluorescent light, the screen may flicker during initial use. Turn off the power switch and then turn it on again to make sure the flicker disappears.
- You may find slightly uneven brightness on the screen depending on the desktop pattern you use.
- The LCD screen has 99.99% or more effective pixels. It may include blemishes of 0.01% or less such as a missing pixel or a pixel lit all the time.
- Due to the nature of the LCD screen, an afterimage of the previous screen may remain after switching the image, when the same image is displayed for hours. In this case, the screen is recovered slowly by changing the image or turning off the power switch for a few hours.

Information for your safety and comfort

Safety instructions

Read these instructions carefully. Keep this document for future reference. Follow all warnings and instructions marked on the product.

Cleaning your monitor

Please carefully follow these guidelines when cleaning the monitor:

- Always unplug the monitor before cleaning.
- Use a soft cloth to wipe the screen and cabinet front and sides.

Connecting/disconnecting the device

Observe the following guidelines when connecting and disconnecting power from the LCD monitor:

- Make sure the monitor is attached to its base before connecting the power cord to the AC power outlet.
- Make sure both the LCD monitor and the computer are turned off before connecting any cable or unplugging the power cord.
- If the system has multiple sources of power, disconnect power from the system by unplugging all power cords from the power supplies.

Accessibility

Be sure that the power outlet you plug the power cord into is easily accessible and located as close to the equipment operator as possible. When you need to disconnect power from the equipment, be sure to unplug the power cord from the electrical outlet.

Safe listening

To protect your hearing, follow these instructions.

- Gradually increase the volume until you can hear it clearly and comfortably and without distortion.
- After setting the volume level, do not increase it after your ears have adjusted.
- Limit the amount of time listening to music at high volume.
- Avoid turning up the volume to block out noisy surroundings.
- Turn the volume down if you can't hear people speaking near you.

Warnings

- Do not use this product near water.
- Do not place this product on an unstable cart, stand or table. If the product falls, it could be seriously damaged.
- Slots and openings are provided for ventilation to ensure reliable operation of the product and to protect it from overheating. These openings must not be blocked or covered. The openings should never be blocked by placing the product on a bed, sofa, rug or other similar surface. This product should never be placed near or over a radiator or heat register, or in a built-in installation unless proper ventilation is provided.
- Never push objects of any kind into this product through cabinet slots as they may touch dangerous voltage points or short-out parts that could result in a fire or electric shock. Never spill liquid of any kind onto or into the product.
- To avoid damage of internal components and to prevent battery leakage, do not place the product on a vibrating surface.
- Never use it under sporting, exercising, or any vibrating environment which will probably cause unexpected short current or damage internal devices.

Using electrical power

- This product should be operated from the type of power indicated on the marking label. If you are not sure of the type of power available, consult your dealer or local

power company.

- Do not allow anything to rest on the power cord. Do not locate this product where people will walk on the cord.
- If an extension cord is used with this product, make sure that the total ampere rating of the equipment plugged into the extension cord does not exceed the extension cord ampere rating. Also, make sure that the total rating of all products plugged into the wall outlet does not exceed the fuse rating.
- Do not overload a power outlet, strip or receptacle by plugging in too many devices. The overall system load must not exceed 80% of the branch circuit rating. If power strips are used, the load should not exceed 80% of the power strip's input rating.
- This product's power cord is equipped with a three-wire grounded plug. The plug only fits in a grounded power outlet. Make sure the power outlet is properly grounded before inserting the power cord plug. Do not insert the plug into a non-grounded power outlet. Contact your electrician for details.



.....

Warning! The grounding pin is a safety feature. Using a power outlet that is not properly grounded may result in electric shock and/or injury.



.....

Note: The grounding pin also provides good protection from unexpected noise produced by other nearby electrical devices that may interfere with the performance of this product.

- Use the product only with the supplied power supply cord set. If you need to replace the power cord set, make sure that the new power cord meets the following requirements: detachable type, UL listed/CSA certified, type SPT-2, rated 7 A 125 V minimum, VDE approved or its equivalent, 4.5 meters (15 feet) maximum length.

Product servicing

Do not attempt to service this product yourself, as opening or removing covers may expose you to dangerous voltage points or other risks. Refer all servicing to qualified service personnel.

Unplug this product from the wall outlet and refer servicing to qualified service

personnel when:

- the power cord or plug is damaged, cut or frayed
- liquid was spilled into the product
- the product was exposed to rain or water
- the product has been dropped or the case has been damaged
- the product exhibits a distinct change in performance, indicating a need for service
- the product does not operate normally after following the operating instructions



Note: Adjust only those controls that are covered by the operating instructions, since improper adjustment of other controls may result in damage and will often require extensive work by a qualified technician to restore the product to normal condition.

Potentially explosive environments

Switch off your device in any area with a potentially explosive atmosphere and obey all signs and instructions. Potentially explosive atmospheres include areas where you would normally be advised to turn off your vehicle engine. Sparks in such areas could cause an explosion or fire resulting in bodily injury or even death. Switch off the device near gas pumps at service stations. Observe restrictions on the use of radio equipment in fuel depots, storage and distribution areas; chemical plants; or where blasting operations are in progress. Areas with a potentially explosive atmosphere are often, but not always, marked. They include below deck on boats, chemical transfer or storage facilities, vehicles using liquefied petroleum gas (such as propane or butane), and areas where the air contains chemicals or particles such as grain, dust or metal powders.

Additional safety information

Your device and its enhancements may contain small parts. Keep them out of the reach of small children.

IT Equipment Recycling Information

Acer is strongly committed to environmental protection and views recycling, in the form of salvaging and disposal of used equipment, as one of the company's top priorities in minimizing the burden placed on the environment.

We at Acer are very conscious of the environmental effects of our business and strive to identify and provide the best working procedures to reduce the environmental impact of our products.

Disposal of Waste Equipment

This symbol on the product or on its packaging indicates that this product must not be disposed of with your other household waste. Instead, it is your responsibility to dispose of your waste equipment by handing it over to a designated collection point for the recycling of waste electrical and electronic equipment. The separate collection and recycling of your waste equipment at the time of disposal will help to conserve natural resources and ensure that it is recycled in a manner that protects human health and the environment. For more information about where you can drop off your waste equipment for recycling, please contact your local office, your household waste disposal service or the shop where you purchased the product.



LCD pixel statement

The LCD unit is produced with high-precision manufacturing techniques. Nevertheless, some pixels may occasionally misfire or appear as black or red dots. This has no effect on the recorded image and does not constitute a malfunction.

This product has been shipped enabled for power management:

- Activate display's Sleep mode within 5 minutes of user inactivity.
- Wake the monitor when it is in Active Off mode, move the mouse or press any keyboard key.

Tips and information for comfortable use

Computer users may complain of eyestrain and headaches after prolonged use. Users are also at risk of physical injury after long hours of working in front of a computer. Long work periods, bad posture, poor work habits, stress, inadequate working conditions, personal health and other factors greatly increase the risk of physical injury.

Incorrect computer usage may lead to carpal tunnel syndrome, tendonitis, tenosynovitis or other musculoskeletal disorders. The following symptoms may appear in the hands, wrists, arms, shoulders, neck or back:

- numbness, or a burning or tingling sensation
- aching, soreness or tenderness

- pain, swelling or throbbing
- stiffness or tightness
- coldness or weakness

If you have these symptoms, or any other recurring or persistent discomfort and/or pain related to computer use, consult a physician immediately and inform your company's health and safety department.

The following section provides tips for more comfortable computer use.

Finding your comfort zone

Find your comfort zone by adjusting the viewing angle of the monitor, using a footrest, or raising your sitting height to achieve maximum comfort. Observe the following tips:

- refrain from staying too long in one fixed posture
- avoid slouching forward and/or leaning backward
- stand up and walk around regularly to remove the strain on your leg muscles

Taking care of your vision

Long viewing hours, wearing incorrect glasses or contact lenses, glare, excessive room lighting, poorly focused screens, very small typefaces and low-contrast displays could stress your eyes. The following sections provide suggestions on how to reduce eyestrain.

Eyes

- Rest your eyes frequently.
- Give your eyes regular breaks by looking away from the monitor and focusing on a distant point.
- Blink frequently to keep your eyes from drying out.

Display

- Keep your display clean.
- Keep your head at a higher level than the top edge of the display so your eyes point downward when looking at the middle of the display.
- Adjust the display brightness and/or contrast to a comfortable level for enhanced text readability and graphics clarity.
- Eliminate glare and reflections by:
 - placing your display in such a way that the side faces the window or any light source

- minimizing room light by using drapes, shades or blinds
 - using a task light
 - changing the display's viewing angle
 - using a glare-reduction filter
 - using a display visor, such as a piece of cardboard extended from the display's top front edge
- Avoid adjusting your display to an awkward viewing angle.
 - Avoid looking at bright light sources, such as open windows, for extended periods of time.

Developing good work habits

Develop the following work habits to make your computer use more relaxing and productive:

- Take short breaks regularly and often.
- Perform some stretching exercises.
- Breathe fresh air as often as possible.
- Exercise regularly and maintain a healthy body.

Acer monitor is purposed for video and visual display of information obtained from electronic devices.



Acer Incorporated
8F, 88, Sec. 1, Xintai 5th Rd., Xizhi
New Taipei City 221, Taiwan

Declaration of Conformity

We,

Acer Incorporated

8F, 88, Sec. 1, Xintai 5th Rd., Xizhi, New Taipei City 221, Taiwan

And,

Acer Italy s.r.l.

Viale delle Industrie 1/A, 20020 Arese (MI), Italy

Tel: +39-02-939-921, Fax: +39-02 9399-2913

www.acer.it

| | |
|----------------------|--|
| Product: | LCD Monitor |
| Trade Name: | Acer |
| Model Number: | XZ272U |
| SKU Number: | XZ272U xxxxxx |
| | ("x" = 0~9, a~z, A~Z, or blank) |

We, Acer Incorporated, hereby declare under our sole responsibility that the product described above is in conformity with the relevant Union harmonization legislations as below Directive and following harmonized standards and/or other relevant standards have been applied:

EMC Directive: 2014/30/EU

EN 55032:2012/AC:2013 Class B

EN 55024:2010

EN 61000-3-2:2014 Class D

EN 61000-3-3:2013

LVD Directive: 2014/35/EU

EN 60950-1:2006/A11:2009/A1:2010/A12:2011/A2:2013

RoHS Directive: 2011/65/EU

EN 50581:2012

ErP Directive: 2009/125/EC

Regulation (EC) No. 1275/ 2008; EN 50564:2011

Year to begin affixing CE marking: 2019.

RU Jan / Sr. Manager
Acer Incorporated (Taipei, Taiwan)

Aug. 01, 2019
Date



Acer America Corporation
333 West San Carlos St., San Jose
Suite 1500
CA 95110, U. S. A.
Tel : 254-298-4000
Fax : 254-298-4147
www.acer.com



Federal Communications Commission Declaration of Conformity

This device complies with Part 15 of the FCC Rules. Operation is subject to the following two conditions: (1) this device may not cause harmful interference, and (2) this device must accept any interference received, including interference that may cause undesired operation.

The following local Manufacturer /Importer is responsible for this declaration:

| | |
|--------------------------------------|---|
| Product: | LCD Monitor |
| Model Number: | XZ272U |
| SKU Number: | XZ272U xxxxxxxx; ("x" = 0~9, a ~ z, or A ~ Z) |
| Name of Responsible Party: | Acer America Corporation |
| Address of Responsible Party: | 333 West San Carlos St. Suite 1500 San Jose, CA 95110 U. S. A. |
| Contact Person: | Acer Representative |
| Phone No.: | 254-298-4000 |
| Fax No.: | 254-298-4147 |

| | |
|--|-----|
| Special notes on LCD monitors | iii |
| Information for your safety and comfort | iii |
| Safety instructions | iii |
| Cleaning your monitor | iii |
| Connecting/disconnecting the device | iii |
| Accessibility | iv |
| Safe listening | iv |
| Warnings | iv |
| Using electrical power | iv |
| Product servicing | v |
| Potentially explosive environments | vi |
| Additional safety information | vi |
| IT Equipment Recycling Information | vi |
| Disposal instructions | vii |
| LCD pixel statement | vii |
| Tips and information for comfortable use | vii |
| Declaration of Conformity | |
| Federal Communications Commission | |
| Declaration of Conformity | |
| Unpacking | 1 |
| Attaching/ Removing the base | 2 |
| Screen position adjustment | 3 |
| Connecting the Power cord | 4 |
| Power saving | 4 |
| Display Data Channel (DDC) | 4 |
| Connector pin assignment | 5 |
| Standard timing table | 6 |
| Installation | 7 |
| Users controls | 9 |
| Using the Shortcut Menu | 9 |
| The Function page | 10 |
| Trouble shooting | 15 |

Unpacking

Please check that the following items are present when you unpack the box, and save the packing materials in case you need to ship or transport the monitor in the future.

LCD monitor



Quick start guide



Adapter

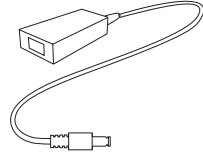

DP cable (Optional)

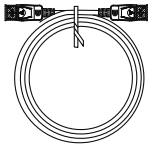

HDMI cable (Optional)

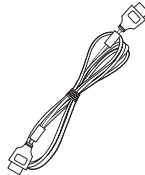

AC Power cord



Attaching/ Removing the base

- 1.Remove the monitor from the packaging.
- 2.Secure the stand to the monitor.
- 3.Secure the base to the stand by turn the screw clockwise using a screwdriver.

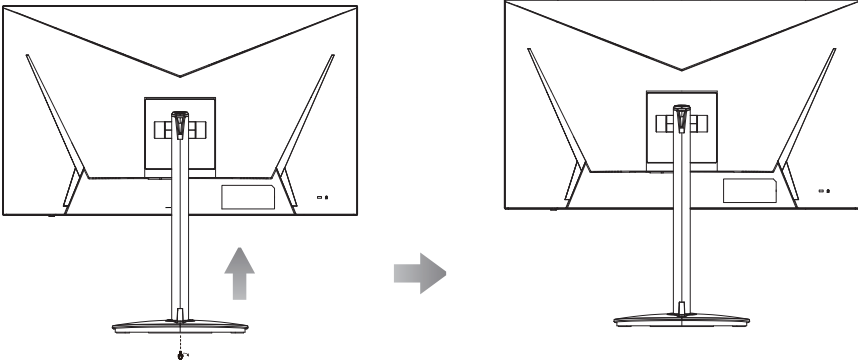

FreeSync (HDMI#B D only):

It can allow a FreeSync supported graphics source to dynamically adjust display refresh rate based on typical content frame rates for power efficient, virtually stutter free and low-latency display update.

Screen position adjustment

To optimize the viewing position, you can adjust the monitor tilt by using both of your hands to hold the edges of the monitor as shown below. The monitor can be adjusted to 25 degrees up or 5 degrees down.

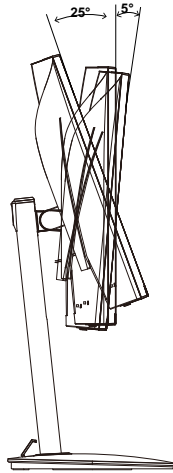

Connecting the Power cord

- Check first to make sure that the power cord you use is the correct type required for your area.
- The monitor has a universal power supply that allows operation in either 100/120 V AC or 220/240 V AC voltage area. No user-adjustment is required.
- Plug one end of the power cord to the AC inlet, and plug the other end into an AC outlet.
- For units using 120 V AC:
Use a UL-listed cord set, type SVT wire and plug rated 10 A/125 V.
- For units using 220/240 V AC:
Use a cord set consisting of H05VV-F cord and plug rated 10 A/250 V. The cord set should have the appropriate safety approvals for the country in which the equipment will be installed.

Power saving

The monitor will be switched to “power saving” mode by the control signal from the display controller, as indicated by the red-colored power LED.

| Mode | LED light |
|--------------|-----------|
| On | Blue |
| Power saving | Red |

The power saving mode will be kept until a control signal has been detected or the keyboard or mouse is activated. The recovery time from “power saving” mode back to “on” is around 3 seconds.

Display Data Channel (DDC)

To make installation easier, so long as your system supports the DDC protocol, the monitor is able to plug-and-play. The DDC is a communication protocol through which the monitor automatically informs the host system about its capabilities; for example, supported resolutions and corresponding timing. The monitor supports the DDC2B standard.

Connector pin assignment

19-Pin Color Display Signal Cable*

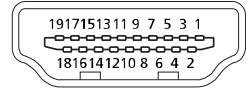

| PIN | Meaning | PIN | Meaning |
|-----|-------------------|-----|---------------------------|
| 1. | TMDS Data2+ | 10. | TMDS Clock+ |
| 2. | TMDS Data2 Shield | 11. | TMDS Clock Shield |
| 3. | TMDS Data2- | 12. | TMDS Clock- |
| 4. | TMDS Data1+ | 13. | CEC |
| 5. | TMDS Data1 Shield | 14. | Reserved (N.C. on device) |
| 6. | TMDS Data1- | 15. | SCL |
| 7. | TMDS Data0+ | 16. | SDA |
| 8. | TMDS Data0 Shield | 17. | DDC/CEC Ground |
| 9. | TMDS Data0- | 18. | +5V Power |
| | | 19. | Hot Plug Detect |

* only for certain models

20-Pin Color Display Signal Cable*

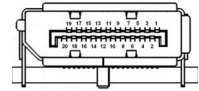

| PIN | Description | PIN | Description |
|-----|-------------|-----|-----------------|
| 1. | Lane0(p) | 11. | GND |
| 2. | GND | 12. | Lane3(n) |
| 3. | Lane0(n) | 13. | Config1 |
| 4. | Lane1(p) | 14. | Config2 |
| 5. | GND | 15. | AUX_CH (n) |
| 6. | Lane1(n) | 16. | GND |
| 7. | Lane2(p) | 17. | AUX_CH (p) |
| 8. | GND | 18. | Hot Plug Detect |
| 9. | Lane3(n) | 19. | DP Power_Return |
| 10. | Lane3(p) | 20. | DP Power |

* only for certain models

Standard timing table

| No | Mode | Resolution | Refresh Rate | |
|----|-----------|------------|--------------|----|
| 1 | VGA | 640x480 | 60 | Hz |
| 2 | | 640x480 | 72 | Hz |
| 3 | | 640x480 | 120 | Hz |
| 4 | MAC | 640x480 | 66.66 | Hz |
| 5 | VESA | 720x400 | 70 | Hz |
| 6 | SVGA | 800x600 | 56 | Hz |
| 7 | | 800x600 | 60 | Hz |
| 8 | | 800x600 | 72 | Hz |
| 9 | | 800x600 | 120 | Hz |
| 10 | XGA | 1024x768 | 60 | Hz |
| 11 | | 1024x768 | 70 | Hz |
| 12 | | 1024x768 | 120 | Hz |
| 13 | VESA | 1152x864 | 75 | Hz |
| 14 | | 1280x960 | 60 | Hz |
| 15 | SXGA | 1280x1024 | 60 | Hz |
| 16 | VESA | 1280x720 | 60 | Hz |
| 17 | WXGA | 1280x800 | 60 | Hz |
| 18 | | 1360x768 | 60 | Hz |
| 19 | WXGA+ | 1440x900 | 60 | Hz |
| 20 | | 1440x900 | 120 | Hz |
| 21 | WSXGA+ | 1680x1050 | 60 | Hz |
| 22 | UXGA | 1600x1200 | 60 | Hz |
| 23 | | 1920x1080 | 60 | Hz |
| 24 | | 1920x1080 | 60 | Hz |
| 25 | | 1920x1080 | 60 | Hz |
| 26 | | 1920x1080 | 75 | Hz |
| 27 | | 1920x1080 | 75 | Hz |
| 28 | | 1920x1080 | 120 | Hz |
| 29 | | 1920x1080 | 144 | Hz |
| 30 | | QHD | 2560x1440 | 60 |
| 31 | 2560x1440 | | 120 | Hz |
| 32 | 2560x1440 | | 144 | Hz |
| 33 | 2560x1440 | | 165 | Hz |



Note: 1. DP: 2560x1440 (up to 165Hz), support FreeSync and HDR technology.
HDMI1/HDMI2: 2560x1440 (up to 144Hz), support FreeSync and HDR technology.

Installation

To install the monitor on your host system, please follow the steps below:

Steps

Connecting Your Monitor to a Computer

1. Turn off your monitor and unplug your computer's power cord.
2. 2-1 Connect HDMI Cable (Option, Only HDMI-input model)
 - a. Make sure both the monitor and computer are powered-OFF.
 - b. Connect the HDMI cable to the computer.
- 2-2 Connect DP Cable (Optional, Only DP-input model)
 - a. Make sure both the monitor and computer are powered-OFF.
 - b. Connect the DP cable to the computer.
3. Insert the monitor power cable into the power port at the back of the monitor.
4. Plug the power cords of your computer and your monitor into a nearby electrical outlet.

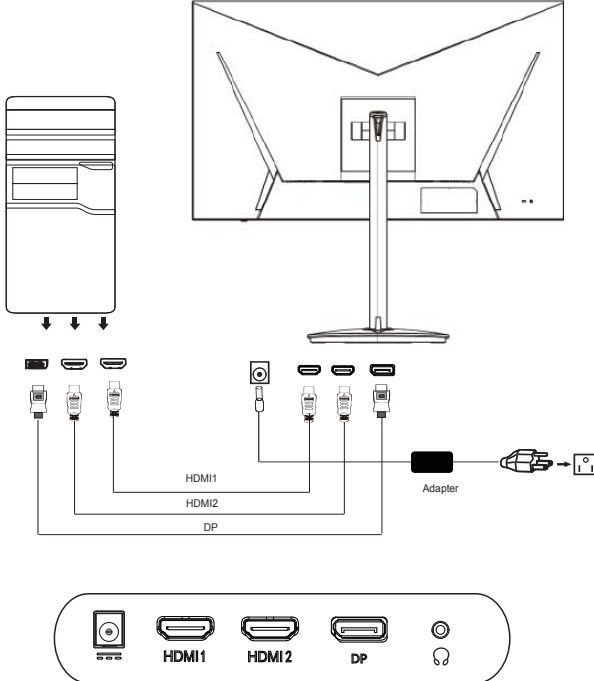

In order to prevent damage to the monitor, do not lift the monitor by its base.

Users controls

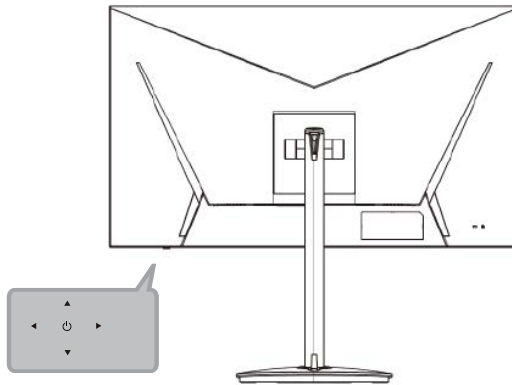

External controls

Function key



- a. Monitor power off status Press to switch power on. In the normal display, anytime to Press more than 5 seconds switch to turn off the power.
- b. Blue indicates power on. Red indicates standby/power saving mode. No light display indicates Power off.
- c. Press to any directions switch key to display First Menu. Press again to enter next function in the First Menu.
- d. The single toggle button on the bottom of the Display bezel operates like a joystick. To move the cursor, simply toggle the button in four directions. Press the button to select desires option. In Main Menu , Red indicates operable, Dark grey indicates inoperable.

Using the Shortcut Menu



Note: The following content is for general reference only. Actual product specifications may vary.

The OSD (onscreen display) can be used to adjust the settings of your LCD monitor. Press the MENU key to open the OSD. You can use the OSD to adjust the picture quality and general settings. For advanced settings, please refer to following page:

Main page

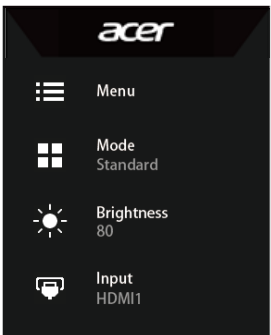
| | |
|---|---|
|  | <ol style="list-style-type: none"> 1. Menu OSD 2. Hot Key1 (Modes, Brightness, Gamma, Contrast, Blue Light, Over Drive) 3. Hot Key2 (Modes, Brightness, Gamma, Contrast, Blue Light, Over Drive) 4. Input selection |
|---|---|

Hot key1 (default: Standard mode)

To choose scenario mode(Action, Racing, Sports, User, Standard, ECO, Graphics, HDR)

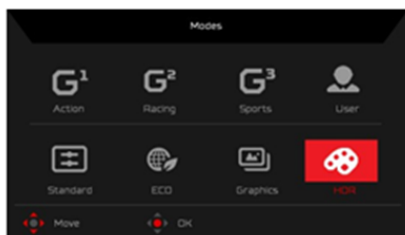

Hot key2 (default: Brightness)

Open the Brightness control and select your preferred brightness setting . When you are done, press the joystick to quit current page and store.

Selecting the input

Open the Input control and select HDMI1, HDMI2, DP or Auto Source. When you are done, press the joystick to exit current page and store.



The Function page

Open the Function page to adjust the functions, settings which you want using the arrows. When you are done, toggle the joystick to the left or right to go back one level.

Adjusting the Picture

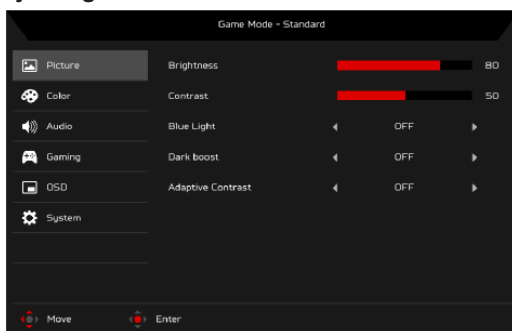

1. Press the MENU key to open the OSD.
2. Toggle the joystick to the up or down to select Picture from the OSD. Then toggle to the right to navigate to the element you wish to adjust and press the joystick to enter it.
3. Toggle to the left or right to adjust the sliding scales.
4. The Picture menu can be used to adjust the Brightness, Contrast, Black Boost, Blue Light, ACM, HDR, Super Sharpness.
5. Brightness: Adjust the brightness from 0 to 100.



Note: Adjusts the balance between light and dark shades.

6. Contrast: Adjust the contrast from 0 to 100.



Note: Sets the degree of difference between light and dark areas.

7. **Black Boost:** This boosts the amplitude of the dark color levels of the display-blacks will be less black.The higher the level,the higher the boost.
8. **Blue Light:** Filters out blue light to protect your eyes by adjusting how much blue light is shown -- 80%, 70%, 60%, or 50%.



Note: Higher values allow more blue light through. For the best protection select a lower value.

9. **ACM:** Turn ACM on or off. The default is off.
10. **HDR:** Turn HDR off,Auto or on. The default is off.Select Auto enables this function to automatically detect and process HDR signal.



Note:

1. HDR=(Auto or On), The source signal content is SDR, the brightness can to adjustment, but content is HDR the brightness is fixed at 100 and gray out.
2. HDR = (Auto or On), features: (ACM/Gamma/Contrast/BlueLight/Color Temp/Black Boost/6-axis Hue & Saturate/FreeSync) is gray out and unavailable, default parameter please refer to "Modes".
3. HDR = (Auto or On), Color Page only shows the adjustable function, other functions (Gamma and Color Temp are hidden).

11. **Super Sharpness:** Turn the Super Sharpness On or Off. Super Sharpness technology can simulate high-resolution images by boosting the pixel density of the original source to make images sharper and clearer.

Adjusting the Color

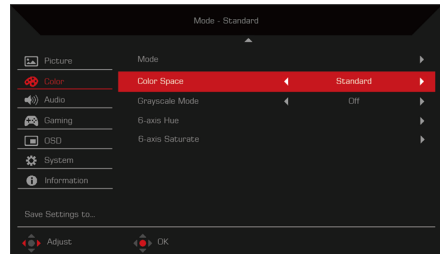
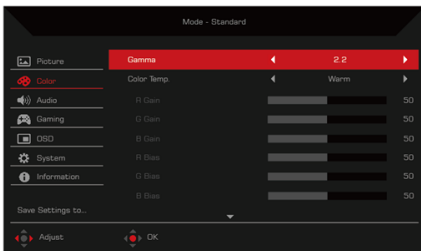

1. Press the MENU key to open the OSD.
2. Toggle the joystick to the up or down to select Color from the OSD.Then toggle to the right to navigate to the element you wish to adjust and press the joystick to enter it.
3. Toggle to the left or right to adjust the sliding scales.
4. Gamma mode allows you to adjust the luminance tone.The default value is 2.2 (standard value for Windows).
5. Color temperature: Default is warm. You can choose Cool, Normal, Warm, Bluelight or User.
6. Modes: further open the modes menu selection.
7. Color Space: You can choose Standard,SMPTE-C,DCI,EBU,HDR,Rec.709 or sRGB.

**Note:**

1. If Color Space is "HDR",then Modes is set to "HDR" automatically.
2. If Color Space is not "HDR",then Modes is set to "Standard".
8. Grayscale Mode: Default is off. Based on favorite to turn on or off.
9. 6-axis Hue: Adjust the red, green, blue, yellow, magenta and cyan hue.
10. 6-axis Saturate: Adjust the red, green, blue, yellow, magenta and cyan saturation.

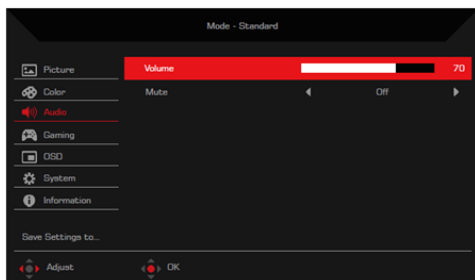
Adjusting the Audio

1. Press the MENU key to open the OSD.
2. Toggle the joystick to the up or down to select Audio from the OSD.Then toggle to the right to navigate to the element you wish to adjust and press the joystick to enter it.
3. Toggle to the left or right to adjust the sliding scales.
4. Volume: Adjust the volume
5. Mute: Default is off. When mute is on, the volume is "0".

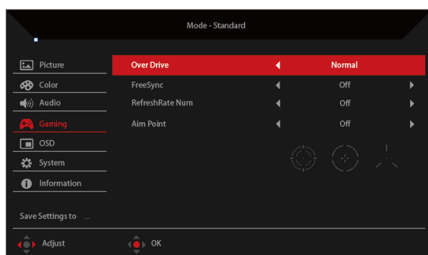
Adjusting the Gaming

1. Press the MENU key to open the OSD.
2. Toggle the joystick to the up or down to select Gaming from the OSD.Then toggle to the right to navigate to the element you wish to adjust and press the joystick to enter it.
3. Toggle to the left or right to adjust the sliding scales.
4. Over Drive: Select Off, Normal, or Extreme.

**Note:**

1. If FreeSync is "ON",then the Over Drive selection is set to "Normal" automatically.
2. If FreeSync is "OFF",then the user can set Over Drive to either one of the three settings including: (a) Extreme (b) Normal (c) Off.

5. Freesync: Select On or Off. FreeSync is available for AMD supported graphic cards only.
6. Refresh rate num: Display the panel's current refresh rate on the screen.



Note: If FreeSync set "On" you can see the V Frequency to changes in the OSD.

7. Aim point: Show an Aim point on the screen for shooting games.



Note: Aim Point is not supported in PBP mode.

Adjusting the OSD

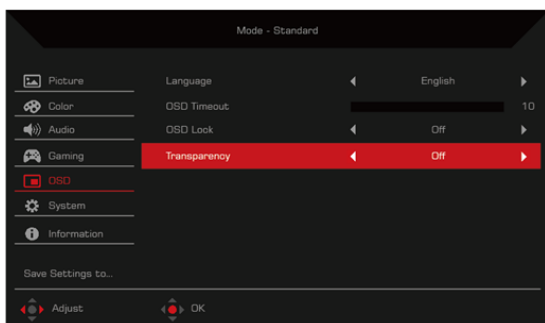

1. Press the MENU key to open the OSD.
2. Toggle the joystick to the up or down to select OSD from the OSD. Then toggle to the right to navigate to the element you wish to adjust and press the joystick to enter it.
3. Toggle to the left or right to adjust the sliding scales.
4. Language: Set the OSD menu language.
5. OSD timeout: Adjust the delay before turning off the OSD menu.
6. Transparency: Select the transparency when using gaming mode. The transparency can be 0% (OFF), 20%, 40%, 60%, or 80%.
7. OSD Lock: OSD Lock function after the start of all Key unavailable.

Adjusting the System

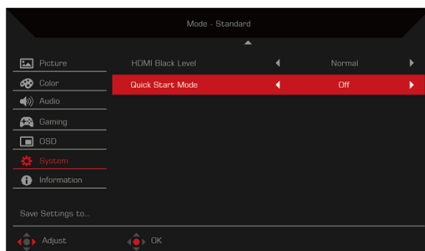
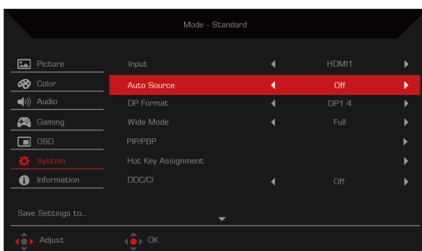

1. Press the MENU key to open the OSD.
2. Toggle the joystick to the up or down to select System from the OSD. Then toggle to the right to navigate to the element you wish to adjust and press the joystick to enter it.

- Toggle to the left or right to adjust the sliding scales.
- Input: Select the source from HDMI 1,HDMI 2,DP.
- Auto Source: Automatically searches for available input sources.
- DP Format: Select the source from DP 1.1,DP1.2, DP1.4
- Wide mode: You can select which screen aspect you are using. The options are Full, Aspect.
- PIP/PBP: The options for PIP/PBP Mode are Off, PIP Large, PIP Small, and PBP. You can also adjust the PIP Position, Sub Source, Source Swap, and Audio Source.
- Hotkey Assignment: Select the function of shortcut key 1 (Modes, Brightness, Volume, Gamma, Contrast, Blue Light, Over Drive) and shortcut keys 2 (Modes, Brightness, Volume, Gamma, Contrast, Blue Light, Over Drive)
- DDC/CI: Allows the monitor settings to be set through the software on the PC.



Note: DDC/CI, short for Display Data Channel/Command Interface, which allows monitor controls to be sent via software.

- HDMI Black Level: You can select the level of blackness under HDMI source. The options are Normal and Low.
- Quick start mode: Select Off or On. Turn on to speed up boot speed.

Information

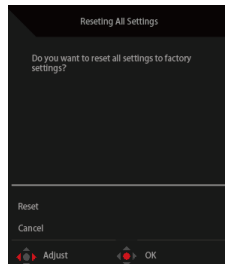
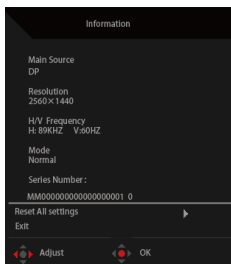
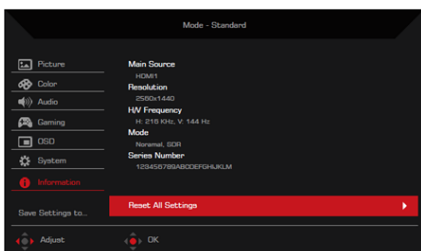

Save Setting to...(User mode only)

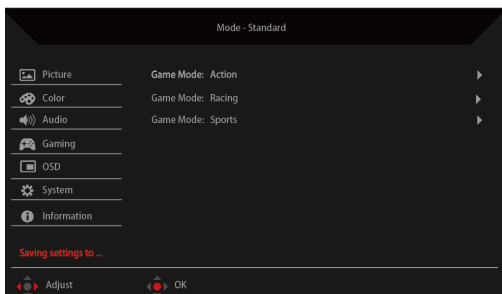

- Press the MENU key to open the OSD.

- Toggle the joystick to the up or down to select "Save Setting to..." from the OSD. Then toggle to the right to navigate to the element you wish to adjust and press the joystick to enter it.

Troubleshooting

Before sending your LCD monitor for servicing, please check the troubleshooting list below to see if you can self-diagnose the problem.

HDMI 1/HDMI 2/DP Mode

| Problem | LED status | Remedy |
|--------------------|------------|--|
| No picture visible | Blue | Using the OSD menu, adjust brightness and contrast to maximum or reset to their default setting. |
| | Off | Check the power switch. Check if the AC power cord is properly connected to the monitor. |
| | Red | Check if the video signal cable is properly connected at the back of monitor. Check if the computer system is switched on and in power saving/standby mode. |