



LCD Monitor User Manual

PhotoVue Photographer Monitor | SW Series

AQ COLOR™
Colors You Can Trust

Copyright

Copyright © 2019 by BenQ Corporation. All rights reserved. No part of this publication may be reproduced, transmitted, transcribed, stored in a retrieval system or translated into any language or computer language, in any form or by any means, electronic, mechanical, magnetic, optical, chemical, manual or otherwise, without the prior written permission of BenQ Corporation.

Disclaimer

BenQ Corporation makes no representations or warranties, either expressed or implied, with respect to the contents hereof and specifically disclaims any warranties, merchantability or fitness for any particular purpose. Further, BenQ Corporation reserves the right to revise this publication and to make changes from time to time in the contents hereof without obligation of BenQ Corporation to notify any person of such revision or changes.

The performance of flicker-free may be affected by external factors such as poor cable quality, unstable power supply, signal interference, or poor grounding, and not limited to the above mentioned external factors. (Applicable for flicker-free models only.)

BenQ ecoFACTS

BenQ has been dedicated to the design and development of greener product as part of its aspiration to realize the ideal of the "Bringing Enjoyment 'N Quality to Life" corporate vision with the ultimate goal to achieve a low-carbon society. Besides meeting international regulatory requirement and standards pertaining to environmental management, BenQ has spared no efforts in pushing our initiatives further to incorporate life cycle design in the aspects of material selection, manufacturing, packaging, transportation, using and disposal of the products. BenQ ecoFACTS label lists key eco-friendly design highlights of each product, hoping to ensure that consumers make informed green choices at purchase. Check out BenQ's CSR Website at <http://csr.BenQ.com/> for more details on BenQ's environmental commitments and achievements.



Power Safety



Please follow these safety instructions for best performance, and long life for your monitor.



- The AC plug isolates this equipment from the AC supply.
- The power supply cord serves as a power disconnect device for pluggable equipment. The socket outlet should be installed near the equipment and be easily accessible.
- This product should be operated from the type of power indicated on the marked label. If you are not sure of the type of power available, consult your dealer or local power company.
- The Class I pluggable equipment Type A must be connected to protective earth.
- An approved power cord greater or equal to H03VV-F or H05VV-F, 2G or 3G, 0.75mm² must be used.

For Germany only:

- (If the weight of the product is less than or equal to 3 kg) An approved power cord greater or equal to H03VV-F, 3G, 0.75mm² must be used.
- (If the weight of the product is more than 3 kg) An approved power cord greater or equal to H05VV-F or H05RR-F, 3G, 0.75mm² must be used.
- (If a remote control is provided) RISK OF EXPLOSION IF BATTERY IS REPLACED BY AN INCORRECT TYPE. DISPOSE OF USED BATTERIES ACCORDING TO THE INSTRUCTIONS.

For models with adapter:

- Use only the power adapter supplied with your LCD Monitor. Use of another type of power adapter will result in malfunction and/or danger.
- Allow adequate ventilation around the adapter when using it to operate the device or charge the battery. Do not cover the power adapter with paper or other objects that will reduce cooling. Do not use the power adapter while it is inside a carrying case.
- Connect the power adapter to a proper power source.
- Do not attempt to service the power adapter. There are no service parts inside. Replace the unit if it is damaged or exposed to excess moisture.

Care And Cleaning

- Do not place the monitor face down on the floor or a desk surface directly. Otherwise, scratches on the panel surface may occur.

- The equipment is to be secured to the building structure before operation.
- (For models that support wall or ceiling mounting)
 - Install your monitor and monitor mounting kit on a wall with flat surface.
 - Ensure that the wall material and the standard wall mount bracket (purchased separately) are stable enough to support the weight of the monitor.
 - Turn off the monitor and the power before disconnecting the cables from the LCD monitor.
- Always unplug the product from the power outlet before cleaning. Clean the LCD monitor surface with a lint-free, non-abrasive cloth. Avoid using any liquid, aerosol or glass cleaners.
- Slots and openings on the back or top of the cabinet are for ventilation. They must not be blocked or covered. Your monitor should never be placed near or over a radiator or heat sources, or in a built-in installation unless proper ventilation is provided.
- Do not place heavy loads on the monitor to avoid possible personal injury or damage to the monitor.
- Consider keeping the box and packaging in storage for use in the future when you may need to transport the monitor.
- Refer to the product label for information on power rating, manufacture date, and identification markings.

Servicing

- Do not attempt to service this product yourself, as opening or removing covers may expose you to dangerous voltages or other risks. If any of the above mentioned misuse or other accident such as dropping or mishandling occurs, contact qualified service personnel for servicing.
- Contact your place of purchase or visit the local website from www.BenQ.com for more support.

Caution



- The monitor should be 50 ~ 70 cm (20 ~ 28 inches) away from your eyes.
- Looking at the screen for an extended period of time causes eye fatigue and may deteriorate your eyesight. Rest your eyes for 5 ~ 10 minutes for every 1 hour of product use.
- Reduce your eye strain by focusing on objects far way.
- Frequent blinking and eye exercise help keep your eyes from drying out.

Table of Contents

Copyright	2
Getting started	6
Getting to know your monitor	8
Front view	8
Back view	8
Connections	9
How to assemble your monitor hardware	10
How to detach the stand and the base	15
Installing shading hood (optional)	17
Adjusting the monitor height	22
Rotating the monitor	23
Viewing angle adjustment	24
Using the monitor wall mounting kit	25
Getting the most from your BenQ monitor	26
How to install the monitor on a new computer	27
How to upgrade the monitor on an existing computer	28
How to install on Windows 10 system	29
How to install on Windows 8 (8.1) system	30
How to install on Windows 7 system	31
How to adjust your monitor	32
The control panel.....	32
Basic menu operation	33
Working with the Color Mode HotKey.....	35
Customizing the hot keys.....	36
Adjusting the display color.....	36
Adjusting display mode.....	37
Choosing an appropriate color mode.....	37
Navigating the main menu	38
Display menu	39
Color Adjustment menu	41
System menu	46
Troubleshooting	50
Frequently asked questions (FAQ).....	50
Need more help?.....	52

Getting started

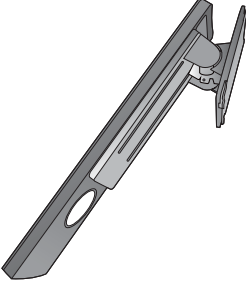
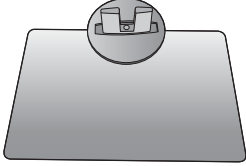
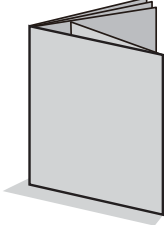
When unpacking please check you have the following items. If any are missing or damaged, please contact the place of purchase for a replacement.

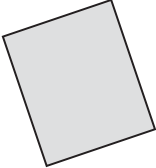
BenQ LCD Monitor	
Monitor Stand	
Monitor Base	
Quick Start Guide	
CD-ROM	
Factory Calibration Report	

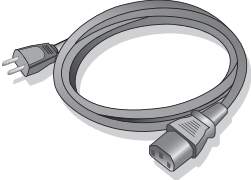
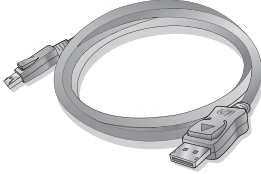
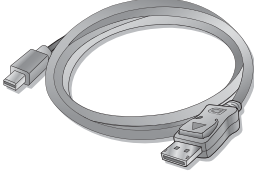
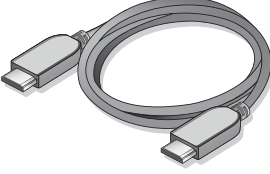
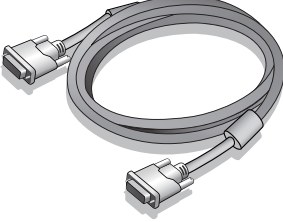
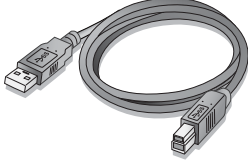
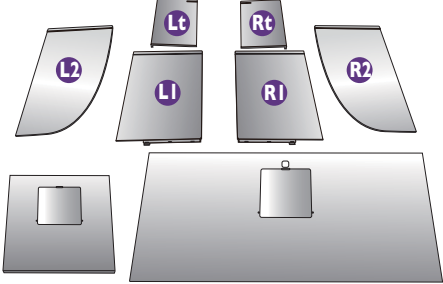
<p>Power Cord (Picture may differ from product supplied for your region.)</p>	
<p>Video Cable: DP (Optional accessory)</p>	
<p>Video Cable: DP to mini DP</p>	
<p>Video Cable: HDMI (Optional accessory)</p>	
<p>Video Cable: DVI-DL (Optional accessory)</p>	
<p>USB Cable</p>	
<p>Shading hood (Optional. Sold separately. Visit BenQ website for information on SH240.)</p>	



• Available accessories and the pictures shown here may differ from the actual contents and the product supplied for your region. And the package contents may subject to change without prior notice. For cables that are not supplied with your product, you can purchase them separately.

• Consider keeping the box and packaging in storage for use in the future when you may need to transport the monitor. The fitted foam packing is ideal for protecting the monitor during transport.



Always keep the product and accessories out of reach of small children.

Getting to know your monitor

Front view

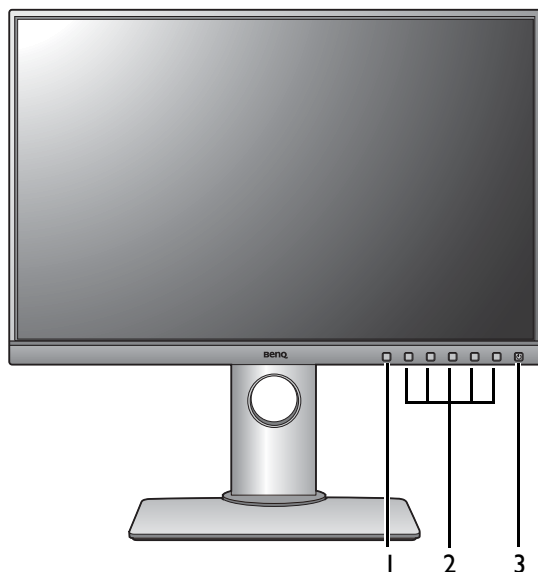

1. Color Mode HotKey
2. Control buttons
3. Power button

Back view

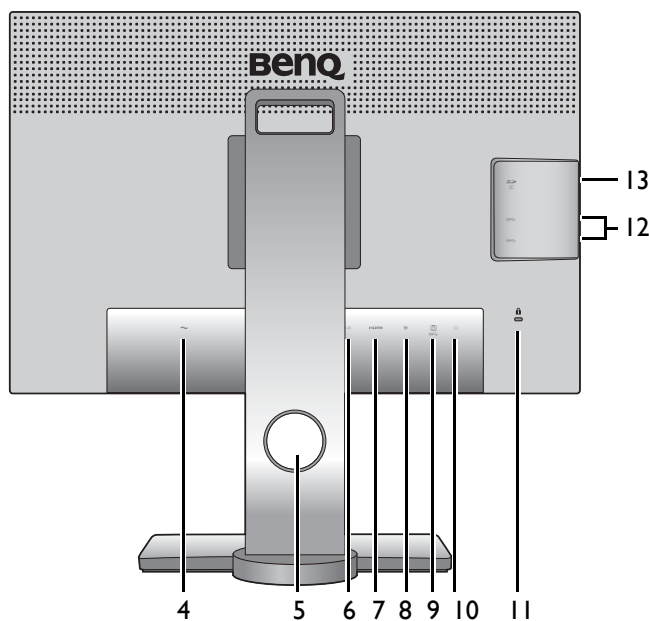

4. AC power input jack
5. Cable management hole
6. DVI-D socket
7. HDMI socket
8. DisplayPort socket
9. USB port (upstream; connecting to the PC)
10. Headphone jack
11. Kensington lock slot
12. USB ports (downstream; connecting to USB devices)
13. SD card slot



- Above diagram may vary depending on the model.
- Picture may differ from product supplied for your region.

Connections

The following connection illustrations are for your reference only. For cables that are not supplied with your product, you can purchase them separately.

For detailed connection methods, see page 11 - 13.

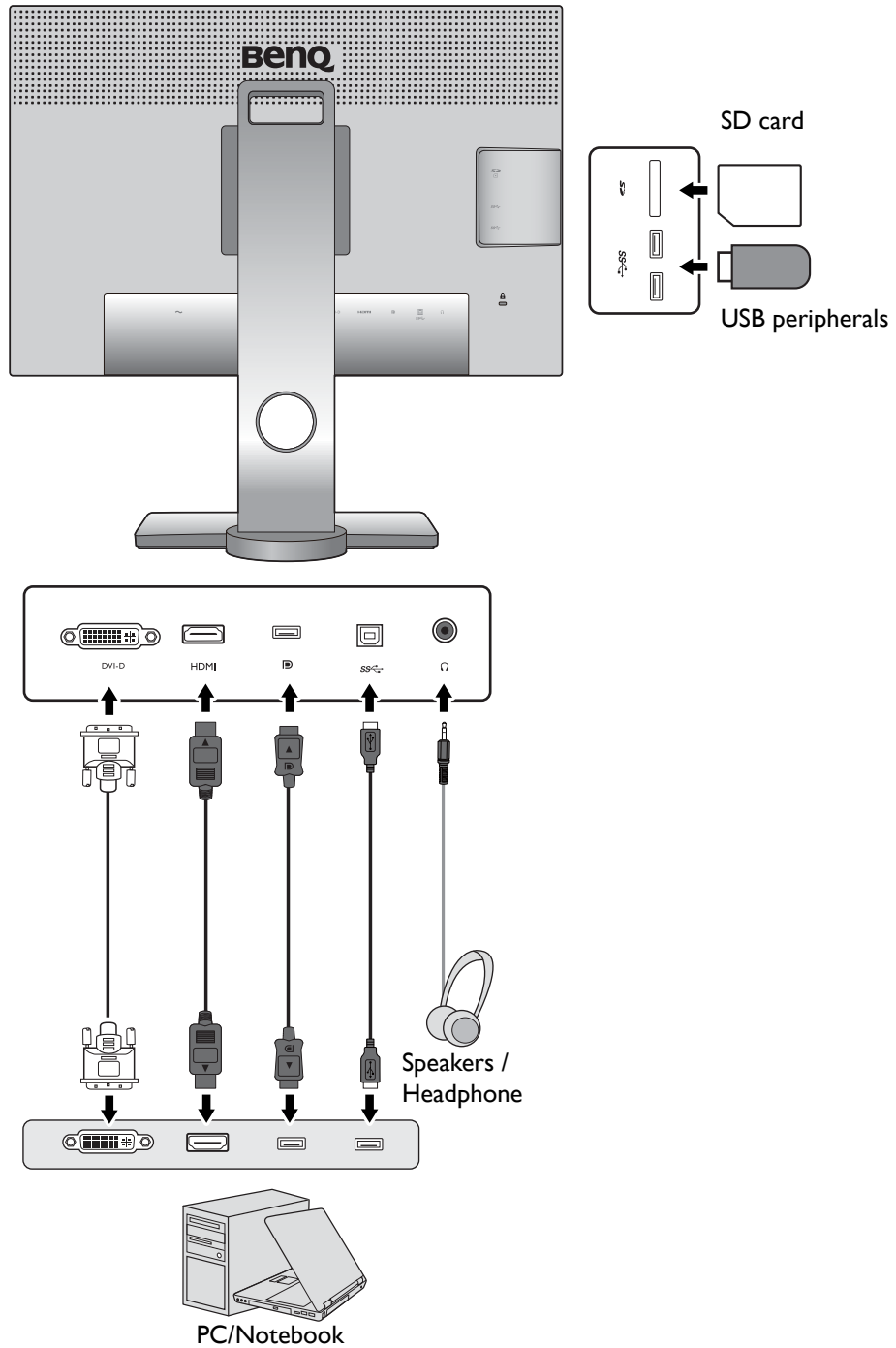

How to assemble your monitor hardware



- If the computer is turned on you must turn it off before continuing. Do not plug-in or turn-on the power to the monitor until instructed to do so.
- The following illustrations are for your reference only. The location and available input and output jacks may vary depending on the purchased model.
- The supported timing may vary by input signal. Refer to the "Preset display modes" section on the link "Adjusting the Screen Resolution" for more information.



Avoid finger pressure on the screen surface.

I. Attach the monitor base.



Please be careful to prevent damage to the monitor. Placing the screen surface on an object like a stapler or a mouse will crack the glass or damage the LCD substrate voiding your warranty. Sliding or scraping the monitor around on your desk will scratch or damage the monitor surround and controls.

Protect the monitor and screen by clearing a flat open area on your desk and placing a soft item like the monitor packaging bag on the desk for padding.

Gently lay the screen face down on a flat clean padded surface.

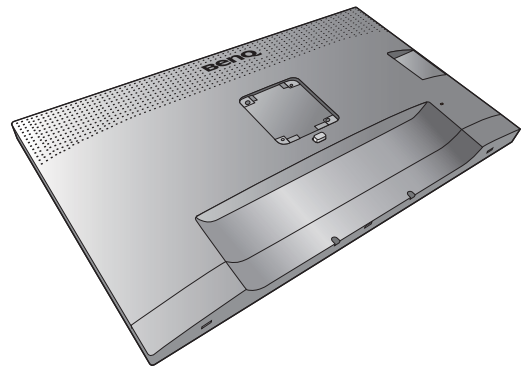

Attach the monitor stand to the monitor base as illustrated.

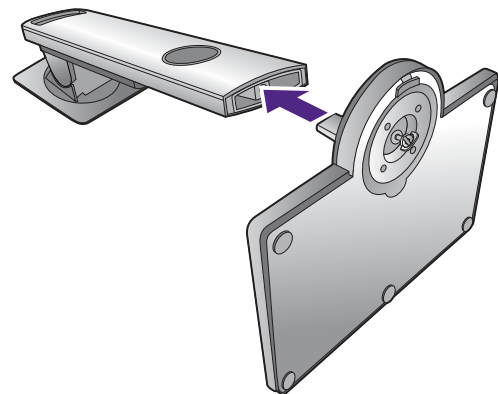

Tighten the thumbscrew on the bottom of the monitor base as illustrated.

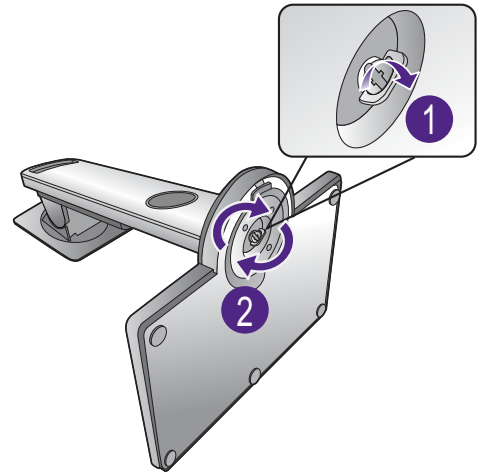



Orient and align the stand arm with the monitor (1), push them together until they click and lock into place (2).

Gently attempt to pull them back apart to check that they have properly engaged.

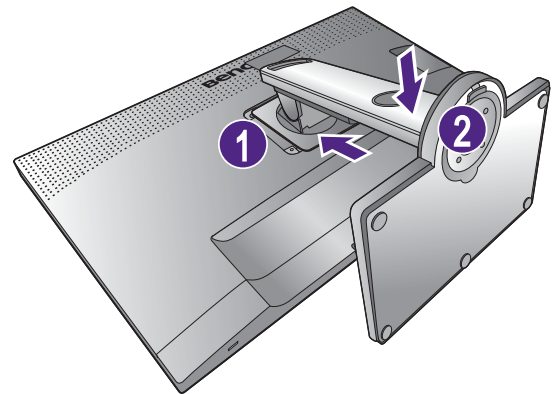
Carefully lift the monitor, turn it over and place it upright on its stand on a flat even surface.



 You should position the monitor and angle the screen to minimize unwanted reflections from other light sources.

 Your monitor is an edge-to-edge monitor, handle it with care. Avoid finger pressure on the screen surface. Adjust the screen angle by placing your hands on the top and on the bottom of the monitor as illustrated. Excessive force on the display is prohibited.

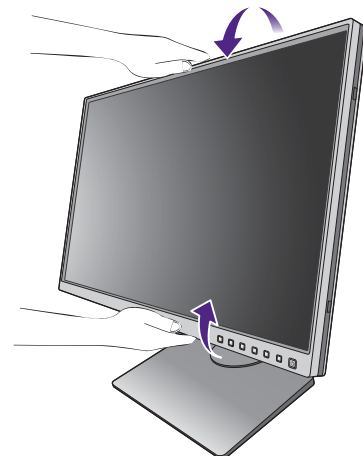

2. Connect the PC video cable

To Connect the DVI-D Cable

Connect the plug of the DVI-D cable (at the end without the ferrite filter) to the monitor video socket. Connect the other end of the cable (at the end with the ferrite filter) to the computer video socket.

Tighten all finger screws to prevent the plugs from accidentally falling out during use.

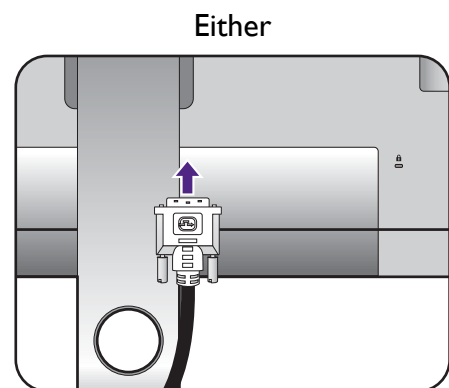

To Connect the HDMI Cable

Connect the plug of the HDMI cable to the HDMI port on the monitor. Connect the other end of the cable to the HDMI port of a digital output device.

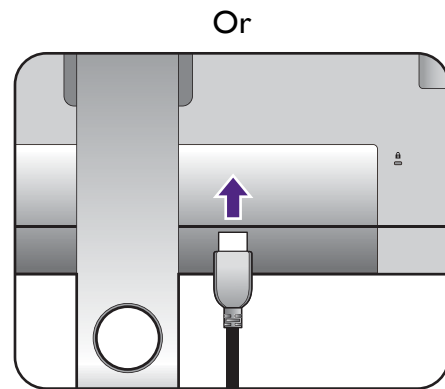

To Connect the DP Cable

Connect the plug of the DP cable to the monitor video socket. Connect the other end of the cable to the computer video socket.

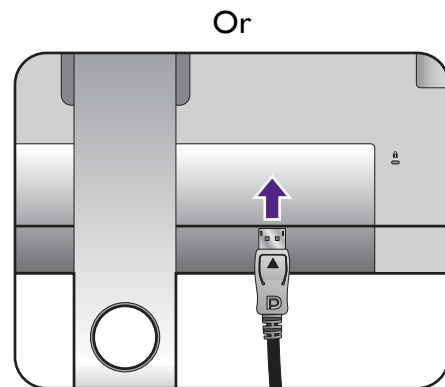

 After the monitor and the computer are powered on, if the image is not displayed, disconnect the DP cable. Connect the monitor to any video source other than DP first. Go to **System** and **DisplayPort** on the OSD menu of the monitor and change the setting from 1.2 to 1.1. Once the setting is done, unplug the current video cable and re-connect the DP cable. To go to the OSD menu, see [Basic menu operation on page 33](#).

 The video cables included in your package and the socket illustrations on the right may vary depending on the product supplied for your region.

3. Connect the audio cable.

You may connect headphones to the headphone jack found on the back side of the monitor.

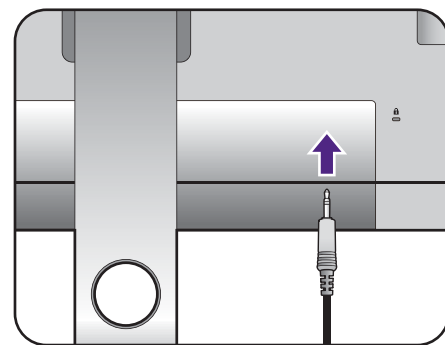

4. Connect USB devices.

To Connect the USB Type-B Cable

Connect the USB cable between the PC and the monitor (via the upstream USB port at the back). This upstream USB port transmits data between the PC and the USB devices connected to the monitor.

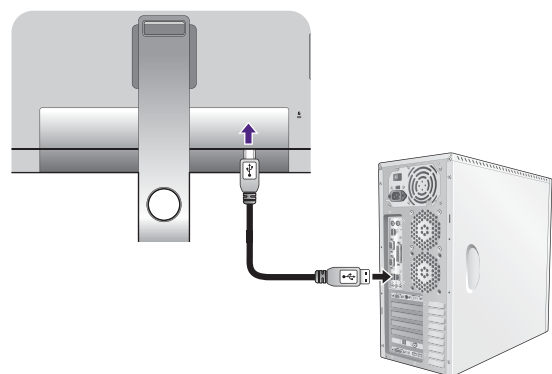

Connect USB devices via other USB ports (downstream) on the monitor. These downstream USB ports transmit data between connected USB devices and the upstream port.

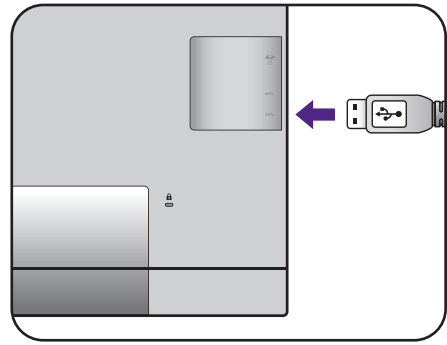

5. Connect the memory card.

Insert an SD or MMC memory card following the direction indicated on the card to exchange files.



Supported memory card formats are as follows:

- SD / SDHC / SDXC
- MMC

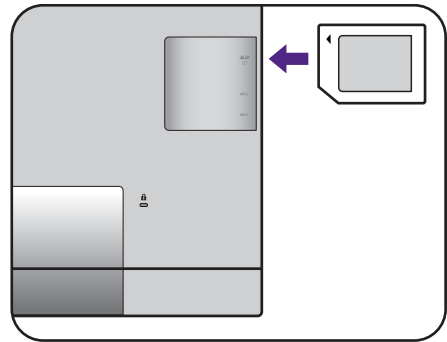

6. Connect the power cable to the monitor.

Plug one end of the power cord into the socket labelled  on the rear of the monitor. Do not connect the other end to a power outlet just yet.

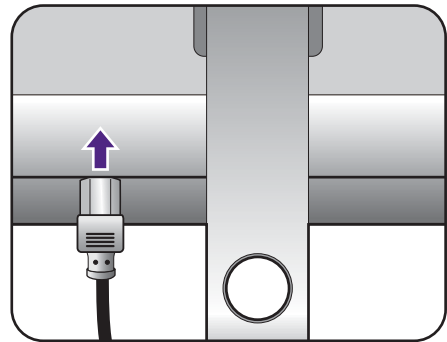

7. Organize the cables.

Route the cables via the cable management hole.

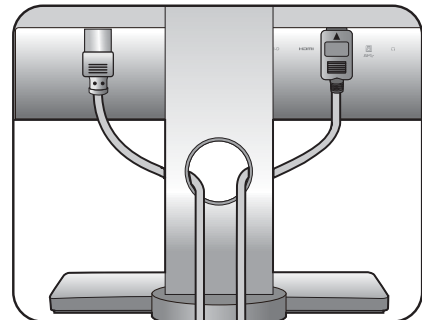

8. Connect-to and turn-on the power.

Plug the other end of the power cord into a power outlet and turn it on.



Picture may differ from product supplied for your region.

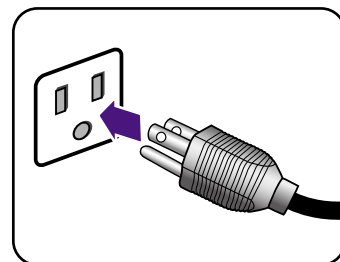

Turn on the monitor by pressing the power button on the monitor.

Turn on the computer too, and follow the instructions in [Getting the most from your BenQ monitor on page 26](#) to install the monitor software.



To extend the service life of the product, we recommend that you use your computer's power management function.

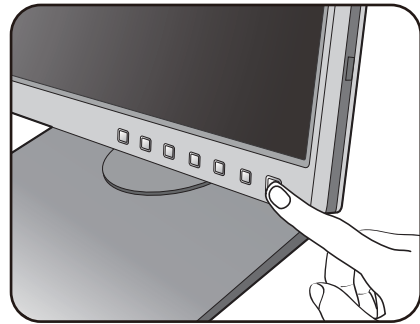

How to detach the stand and the base

1. Prepare the monitor and area.

Turn off the monitor and the power before unplugging the power cable. Turn off the computer before unplugging the monitor signal cable.

Protect the monitor and screen by clearing a flat open area on your desk and placing a soft item like a towel on the desk for padding, before laying the screen face down on a flat clean padded surface.



Please be careful to prevent damage to the monitor. Placing the screen surface on an object like a stapler or a mouse will crack the glass or damage the LCD substrate voiding your warranty. Sliding or scraping the monitor around on your desk will scratch or damage the monitor surround and controls.

2. Remove the monitor stand.

While pressing and holding the quick release button (1), detach the stand from the monitor (2).

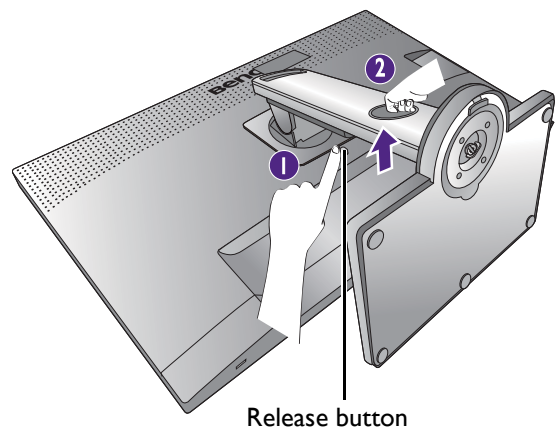
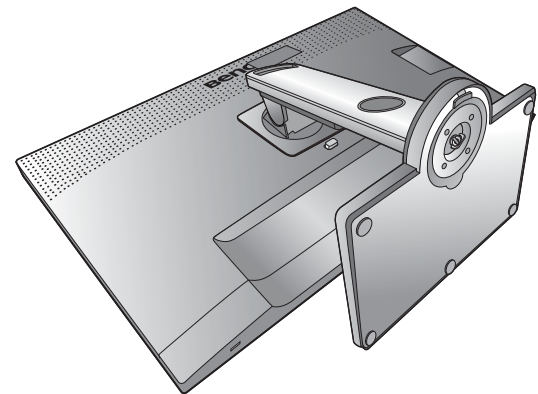

3. Remove the monitor base.

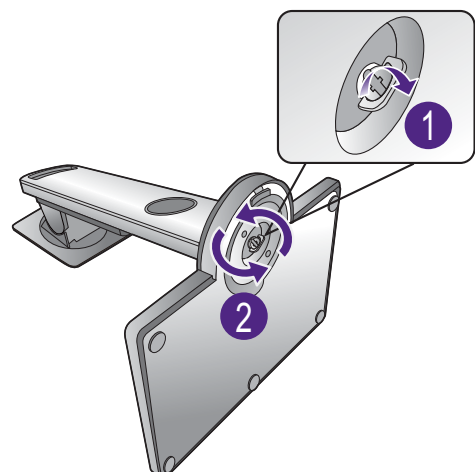

Release the thumbscrew on the bottom of the monitor base.

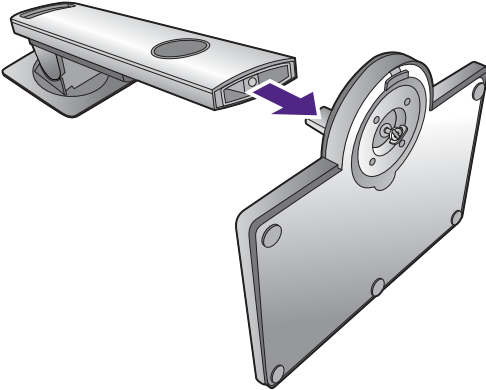

And then detach the base from the stand.



Installing shading hood (optional)

-  The compatible shading hood is SH240, which is sold separately. Visit BenQ website for more information.
-  To prevent glare or most of unwanted reflections from other light sources off your screen, you can install the shading hood (provided or purchased separately, depending on the product supplied for your region).
- 
 - Please be careful to prevent damage to the shading hood and the monitor. Different pieces of shading hood are well-designed and can fit into your monitor properly. Do not use excessive force when installing the shading hood to avoid possible damage.
 - Avoid finger pressure on the screen surface.

You can find the carved arrows on the inner side of some plates. Refer to the installation requirements and the printed marks to prepare the plates needed for landscape and portrait installation separately.

Landscape installation

Plates required for landscape installation:

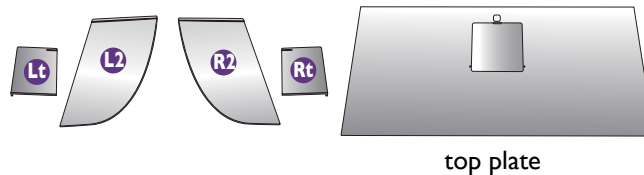

1. Prepare for the shading hood installation.

Place the monitor upright on its stand on a flat even surface. Make sure the monitor is rotated to the landscape mode.

Follow the illustrations to complete the installation carefully.

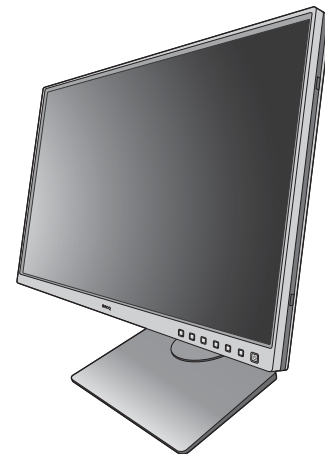

2. Install the right hoods.

Align the arrow on plate (Rt) with the one on plate (R2) and attach them together. Slide plate (Rt) to the end as illustrated.

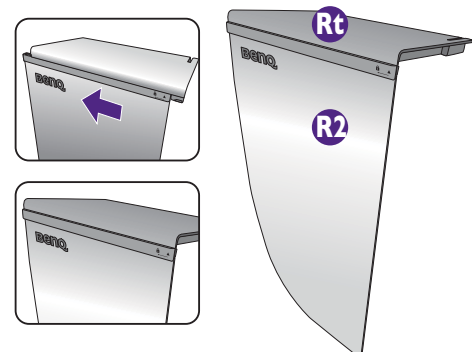

3. Attach to the right side of the monitor.

Align the hooks on the hood (plate R2) with the holes on the right side of the monitor, and insert the hooks. After that, press down plate (Rt) to fix it firmly.

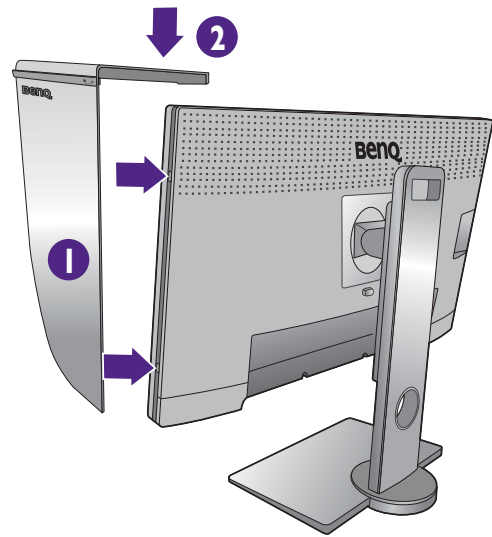

4. Install the left hoods.

Align the arrow on plate (Lt) with the one on plate (L2) and attach them together. Slide plate (Lt) to the end as illustrated.

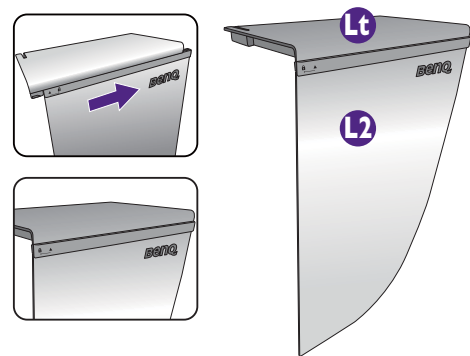

5. Attach to the left side of the monitor.

Align the hooks on the hood (plate L2) with the holes on the left side of the monitor, and insert the hooks. After that, press down plate (Lt) to fix it firmly.

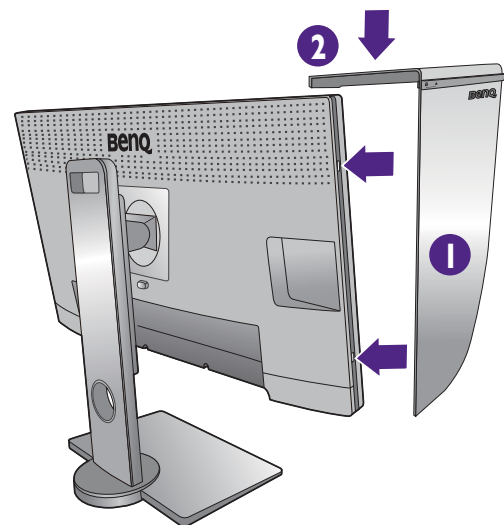

6. Install the top plate.

Hook the top plate on plate (R2) and plate (L2) as illustrated, and insert the top plate to the notch on the top of the other plates.

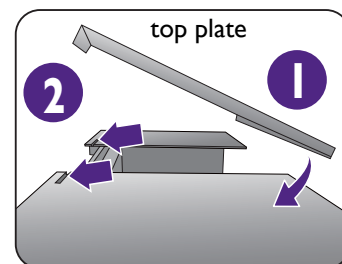

7. If you intend to calibrate the display's color by a colorimeter, slide to open the cover on the top plate so the colorimeter can be installed.



Follow the instruction manuals of the colorimeter you purchased and the provided software (e.g., **Palette Master Element**) to complete the installation and calibration process.

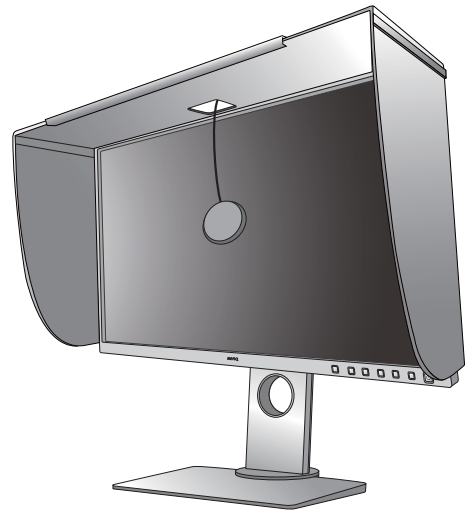

Portrait installation

Plates required for portrait installation:

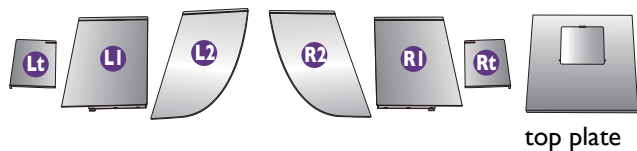

1. Prepare for the shading hood installation.

Place the monitor upright on its stand on a flat even surface. Make sure the monitor is rotated to the portrait mode as instructed in [Rotating the monitor on page 23](#).

Follow the illustrations to complete the installation carefully.



2. Install the right hoods.

Align the arrow on plate (R1) with the one on plate (R2) and attach them together. Slide plate (R2) to the end as illustrated.

Align the arrow on plate (Rt) with the one on plate (R1) and attach them together. Slide plate (R1) along with plate (R2) to the end as illustrated.

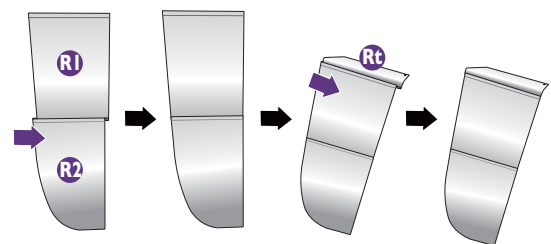

3. Attach to the right side of the monitor.

Align the hooks on the hood with the holes on the right side of the monitor, and insert the hooks. After that, press down plate (Rt) to fix it firmly.

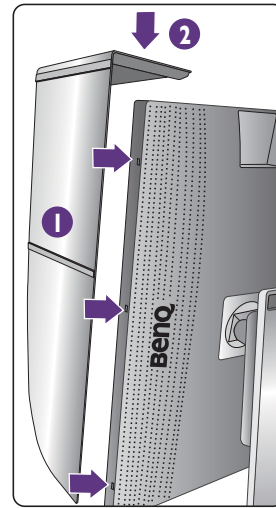

4. Install the left hoods.

Align the arrow on plate (L1) with the one on plate (L2) and attach them together. Slide plate (L2) to the end as illustrated.

Align the arrow on plate (Lt) with the one on plate (L1) and attach them together. Slide plate (L1) along with plate (L2) to the end as illustrated.

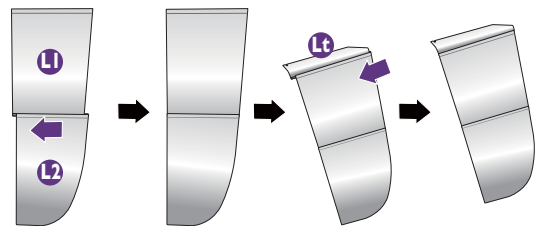

5. Attach to the left side of the monitor.

Align the hooks on the hood with the holes on the left side of the monitor, and insert the hooks. After that, press down plate (Lt) to fix it firmly.

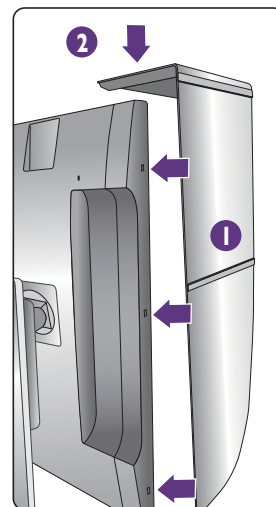

6. Install the top plate.

Hook the top plate on plate (R2) and plate (L2) as illustrated, and the top plate to the notch on the top of the other plates.

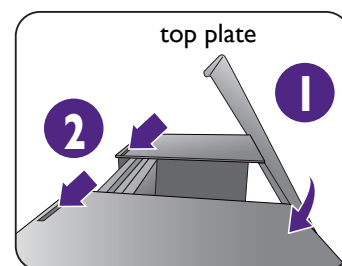

7. If you intend to calibrate the display's color by a colorimeter, slide to open the cover on the top plate so the colorimeter can be installed.



Follow the instruction manuals of the colorimeter you purchased and the provided software (e.g., **Palette Master Element**) to complete the installation and calibration process.

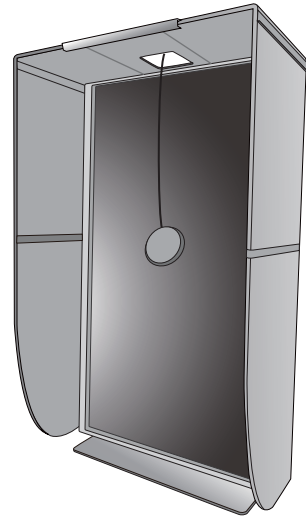

Adjusting the monitor height

Adjust the screen height as illustrated. Excessive force on the display is prohibited.

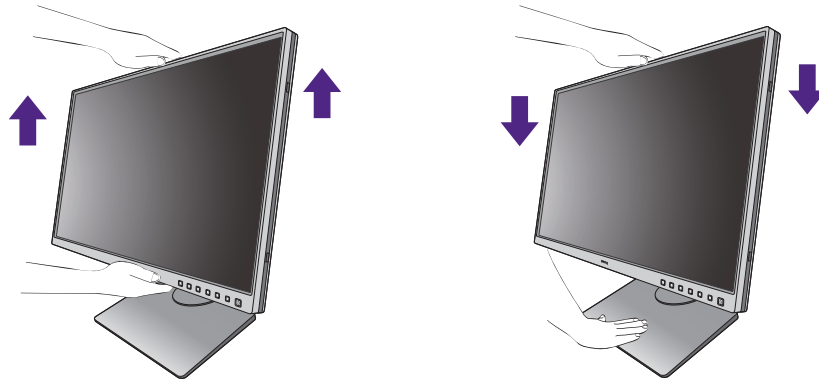

- Avoid placing hands on the upper or lower part of the height-adjustable stand or at the bottom of the monitor, as ascending or descending monitor might cause personal injuries. Keep children out of reach of the monitor while performing this operation.

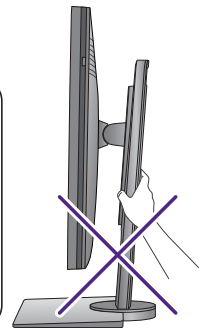
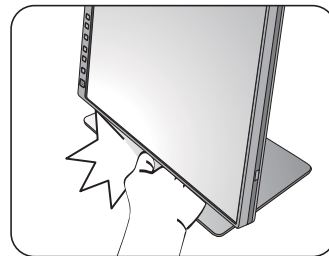

- If the monitor has been rotated to portrait mode and height adjustment is desired, you should be noted that the wide screen will keep the monitor from being lowered to its minimum height.



Rotating the monitor

 Rotate the monitor before installing the shading hood. See [Portrait installation on page 19](#) for more information.

1. Pivot the display.

Before rotating the monitor with a portrait viewing orientation, the display has to be rotated 90 degrees.

Right-click the desktop and select **Screen resolution** from the popup menu. Select **Portrait in Orientation**, and apply the setting.

 Depending on the operating system on your PC, different procedures should be followed to adjust the screen orientation. Refer to the help document of your operating system for details.

2. Fully extend the monitor and tilt it.

Gently lift the display up and extend it to the maximum extended position. Then tilt the monitor.

 The monitor should be vertically extended to allow to rotate from landscape to portrait mode.

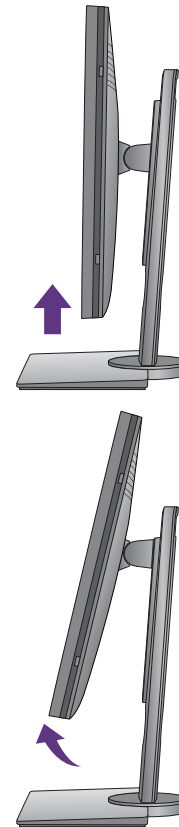

3. Rotate the monitor 90 degrees clockwise as illustrated.

 To avoid the edge of the LCD display hitting the monitor base surface while it is being rotated, do tilt and extend the monitor to the highest position before you start to rotate the display. You should also make sure there are no obstacles around the monitor and there is enough room for cables. Remove the connected USB peripherals and audio cable first.



4. Adjust the monitor to the desired viewing angle.



Viewing angle adjustment

You may position the screen to the desired angle with monitor tilt, swivel, and height adjustment functions. Refer to the product specifications for details.

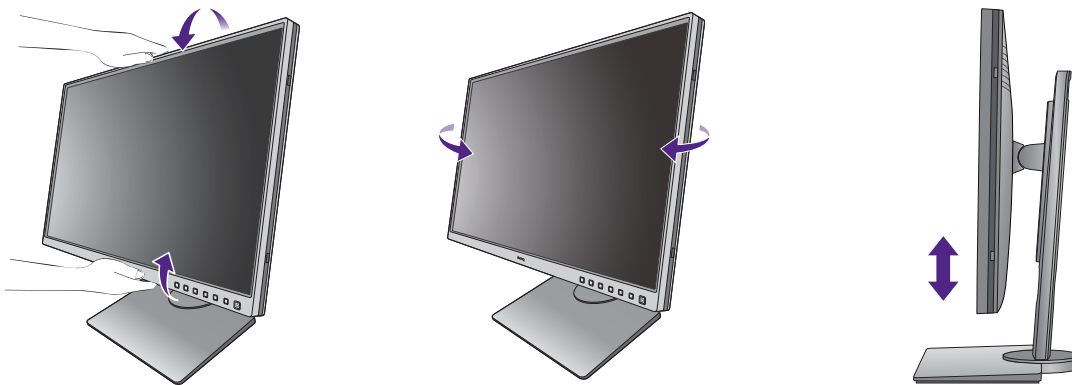

Avoid finger pressure on the screen surface.

Using the monitor wall mounting kit

The back of your LCD monitor has a VESA standard mount with 100mm pattern, allowing the installation of a wall mount bracket. Before starting to install a monitor wall mounting kit, please read the precautions carefully.

Precautions

- Install your monitor and monitor mounting kit on a wall with flat surface.
- Ensure that the wall material and the standard wall mount bracket (purchased separately) are stable enough to support the weight of the monitor. Refer to the product specifications for weight information.
- Turn off the monitor and the power before disconnecting the cables from the LCD monitor.

1. Remove the monitor stand.

Lay the screen face down on a clean and well-padded surface. Detach the monitor stand as instructed in step 1~2 in [How to detach the stand and the base on page 15](#).

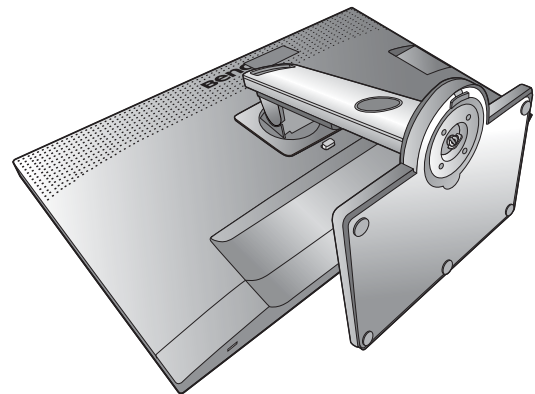

2. Remove the screws on the back cover.

Use a cross-pointed screwdriver to release the screws on the back cover. The use of a magnetic-head screwdriver is recommended to avoid losing the screws.

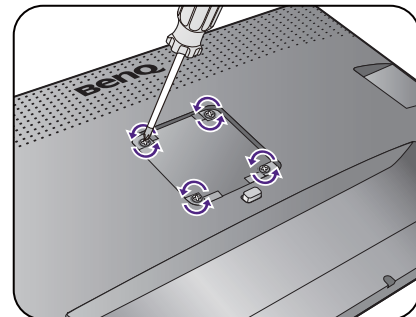

In case you intend to use your monitor on the stand in the future, please keep the monitor base, monitor stand, and screws somewhere safe for future use.

3. Follow the instruction manuals of the wall mount bracket you purchased to complete the installation.



Use four M4 x 10 mm screws to fix a VESA standard wall mount bracket to the monitor. Make sure that all screws are tightened and secured properly. Consult a professional technician or BenQ service for wall mount installation and safety precautions.

Getting the most from your BenQ monitor

To gain the most benefit from your new BenQ LCD monitor, you should install the custom BenQ LCD Monitor driver software as provided on the BenQ LCD Monitor CD-ROM.

The circumstances under which you connect and install your BenQ LCD Monitor will determine which process you need to follow to successfully install the BenQ LCD Monitor driver software. These circumstances relate to which version of Microsoft Windows you are using, and whether you are connecting the monitor and installing the software onto a new computer (without existing monitor driver software), or whether you are upgrading an existing installation (which already has existing monitor driver software) with a newer monitor.

In either case however, the very next time you turn on your computer (after connecting the monitor to your computer), Windows will automatically recognize the new (or different) hardware, and will launch its **Found New Hardware wizard**.

Follow the wizard instructions until it asks you to select a monitor model. At that point, click the **Have Disk** button, insert the BenQ LCD Monitor CD-ROM and select the appropriate monitor model. Further details and step-by-step instructions for either an automatic (new) or upgrade (existing) installation, see:

- [How to install the monitor on a new computer on page 27.](#)
- [How to upgrade the monitor on an existing computer on page 28.](#)



- If you require a User Name and Password to login to your Windows computer, you must be logged on as an Administrator or as a member of the Administrators group in order to install the monitor driver software. Furthermore, if your computer is connected to a network which has security access requirements, network policy settings may prevent you from installing software on your computer.
 - To check the name of the purchased model, refer to the specification label on the back of the monitor.
-

How to install the monitor on a new computer

This instruction details the procedure for selecting and installing the BenQ LCD Monitor driver software on a new computer which has never had a monitor driver installed before. This instruction is only suitable for a computer which has never been used before, and for which the BenQ LCD Monitor is the first ever monitor to be connected to it.



If you are adding the BenQ LCD Monitor to an existing computer that has already had another monitor connected to it (and has monitor driver software installed), you should not be following these instructions. You should instead be following the instructions for [How to upgrade the monitor on an existing computer](#).

1. Follow the instructions in [How to assemble your monitor hardware on page 10](#).
When Windows starts, it will automatically detect the new monitor and launch the **Found New Hardware Wizard**. Follow the prompts until it displays the option to **Install Hardware Device Drivers**.
2. Insert the BenQ LCD Monitor CD-ROM into a CD drive on the computer.
3. Check **Search for a suitable driver for my device** option, and click **Next**.
4. Check the option for CD-ROM drives (uncheck all others) and click **Next**.
5. Look to confirm that the wizard has selected the correct name of your monitor and click **Next**.
6. Click **Finish**.
7. Restart the computer.

How to upgrade the monitor on an existing computer

This instruction details the procedure for manually updating the existing monitor driver software on your Microsoft Windows computer. It is currently tested as compatible for Windows 10, Windows 8 (8.1), and Windows 7 Operating System (OS).



The BenQ LCD Monitor driver for your model may well function perfectly with other versions of Windows, however, as at the time of writing, BenQ has done no testing of this driver on other versions of Windows and cannot guarantee its operation on those systems.

Installing monitor driver software involves selecting an appropriate information file (.inf) on the BenQ LCD Monitor CD-ROM for the particular model monitor you have connected, and letting Windows install the corresponding driver files from the CD. You need only steer it in the right direction. Windows has an Upgrade Device Driver Wizard to automate the task and guide you through the file selection and installation process.

See:

- [How to install on Windows 10 system on page 29.](#)
- [How to install on Windows 8 \(8.1\) system on page 30.](#)
- [How to install on Windows 7 system on page 31.](#)

How to install on Windows 10 system

1. Open **Display Properties**.

Go to **Start, Settings, Devices, Devices and Printers** and right-click the name of your monitor from the menu.

2. Select **Properties** from the menu.

3. Click the **Hardware** tab.

4. Click **Generic PnP Monitor**, and then the **Properties** button.

5. Click the **Driver** tab and the **Update Driver** button.

6. Insert the BenQ LCD Monitor CD-ROM into a CD drive on the computer.

7. In the **Update Driver Software** window, select the option **Browse my computer for driver software**.

8. Click **Browse** and navigate to the following directory: d:\BenQ_LCD\Driver\ (where d is the drive letter designator for the CD-ROM drive).



The drive letter for your CD drive may differ from the example above depending upon your system - it may be 'D:' or 'E:' or 'F:' etc.

9. Select the correct folder name of your monitor from provided driver list, and click **Next**.

This will copy and install the appropriate monitor driver files to your computer.

10. Click **Close**.

You may be prompted to restart your computer after the driver update is complete.

How to install on Windows 8 (8.1) system

1. Open **Display Properties**.

Move the cursor to the lower-right of the screen or press the **Windows + C** buttons on the keyboard to bring up the **Charm** bar. Go to **Settings, Control Panel, Devices and Printers** and right-click the name of your monitor from the menu.

Alternatively, right-click the desktop and select **Personalize, Display, Devices and Printers**, and right-click the name of your monitor from the menu.

2. Select **Properties** from the menu.

3. Click the **Hardware** tab.

4. Click **Generic PnP Monitor**, and then the **Properties** button.

5. Click the **Driver** tab and the **Update Driver** button.

6. Insert the BenQ LCD Monitor CD-ROM into a CD drive on the computer.

7. In the **Update Driver Software** window, select the option **Browse my computer for driver software**.

8. Click **Browse** and navigate to the following directory: d:\BenQ_LCD\Driver\ (where d is the drive letter designator for the CD-ROM drive).



The drive letter for your CD drive may differ from the example above depending upon your system - it may be 'D:' or 'E:' or 'F:' etc.

9. Select the correct folder name of your monitor from provided driver list, and click **Next**.

This will copy and install the appropriate monitor driver files to your computer.

10. Click **Close**.

You may be prompted to restart your computer after the driver update is complete.

How to install on Windows 7 system

1. Open **Display Properties**.

Go to **Start, Control Panel, Hardware and Sound, Devices and Printers** and right-click the name of your monitor from the menu.

Alternatively, right-click the desktop and select **Personalize, Display, Devices and Printers**, and right-click the name of your monitor from the menu.

2. Select **Properties** from the menu.
3. Click the **Hardware** tab.
4. Click **Generic PnP Monitor**, and then the **Properties** button.
5. Click the **Driver** tab and the **Update Driver** button.
6. Insert the BenQ LCD Monitor CD-ROM into a CD drive on the computer.
7. In the **Update Driver Software** window, select the option **Browse my computer for driver software**.
8. Click **Browse** and navigate to the following directory: d:\BenQ_LCD\Driver\ (where d is the drive letter designator for the CD-ROM drive).



The drive letter for your CD drive may differ from the example above depending upon your system - it may be 'D:' or 'E:' or 'F:' etc.

9. Select the correct folder name of your monitor from provided driver list, and click **Next**.
This will copy and install the appropriate monitor driver files to your computer.
10. Click **Close**.
You may be prompted to restart your computer after the driver update is complete.

How to adjust your monitor

The control panel

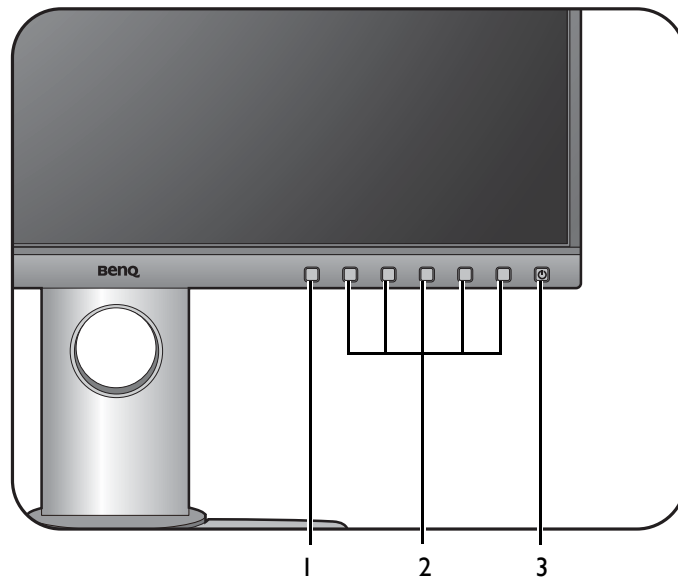

No.	Name	Description
1.	Color Mode HotKey	Accesses Color Mode menu for quick adjustment.
2.	Control keys	Accesses the functions or menu items displayed on the screen, right next to each key.
3.	Power key	Turns the power on or off.

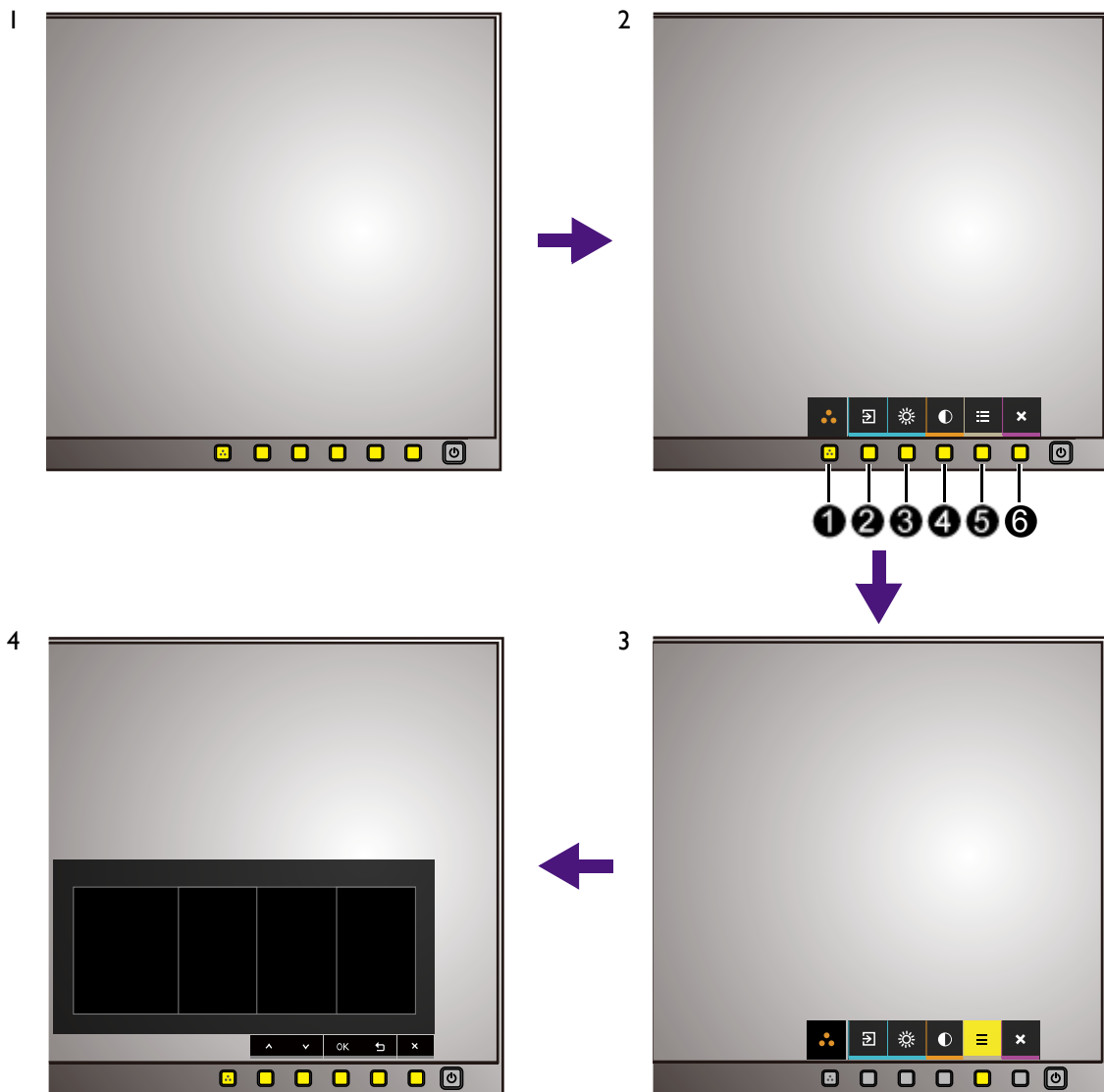

Basic menu operation

All OSD (On Screen Display) menus can be accessed by the control keys. You can use the OSD menu to adjust all the settings on your monitor.



1. Press any of the control keys.
2. The hot key menu is displayed. Some of the controls are custom keys and are designated for particular functions.
3. Select  (**Menu**) to access the main menu.

4. In the main menu, follow the icons next to the control keys to make adjustments or selection. See [Navigating the main menu on page 38](#) for details on the menu options.

No.	OSD in hot key menu	OSD icon in main menu	Function
①	Color Mode HotKey 		<ul style="list-style-type: none"> • Press to access the Color Mode HotKey menu. See Working with the Color Mode HotKey on page 35. • Press and hold for 5 seconds to customize the Color Mode HotKey. To change settings, see Customizing the Color Mode HotKey on page 35.
②	Custom Key 1	^	<ul style="list-style-type: none"> • By default, the key is the hot key for Input. To change the default settings, see Customizing the hot keys on page 36. • For Up/Increase adjustment.
③	Custom Key 2	v	<ul style="list-style-type: none"> • By default, the key is the hot key for Brightness. To change the default settings, see Customizing the hot keys on page 36. • For Down/Decrease adjustment.
④	Custom Key 3	→ / OK	<ul style="list-style-type: none"> • By default, the key is the hot key for Contrast. To change the default settings, see Customizing the hot keys on page 36. • Enters sub menus. • Selects menu items.
⑤	Menu	↶	<ul style="list-style-type: none"> • Activates the main menu. • Returns to the previous menu.
⑥	Exit	✕	Exits OSD menu.





- OSD = On Screen Display.

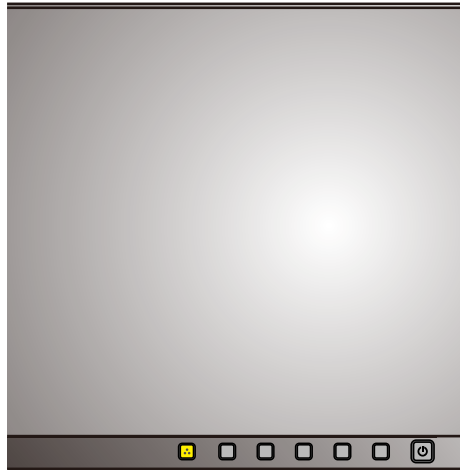

The hot keys only operate while the main menu is not currently displaying. Hot key displays will disappear after a few seconds of no key activity.

- To unlock the OSD controls, press and hold any key for 10 seconds.

Working with the Color Mode HotKey



The Color Mode HotKey () provides quick access to adjust the Color Mode.

1. Press the  key to bring up the pre-defined Color Mode HotKey menu.
2. Keep pressing the  key to cycle through the 3 options to the preferred one. Wait for 3 seconds to confirm the selection.

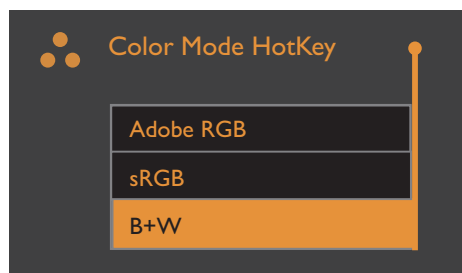

Customizing the Color Mode HotKey

All the pre-defined items on the Color Mode HotKey menu can be changed.

1. Press and hold the  key for 5 seconds to bring up the Color Mode HotKey setting menu.
2. On the Color Mode HotKey menu (on the left), use \wedge or \vee to select the item to be replaced.
3. Use \rightarrow to go to the list of all Color Mode options (on the right). Use \wedge or \vee to select your preferred item.
4. Confirm with OK . The Color Mode HotKey menu is now updated.

- Follow the above procedures to customize other options on the Color Mode HotKey menu.

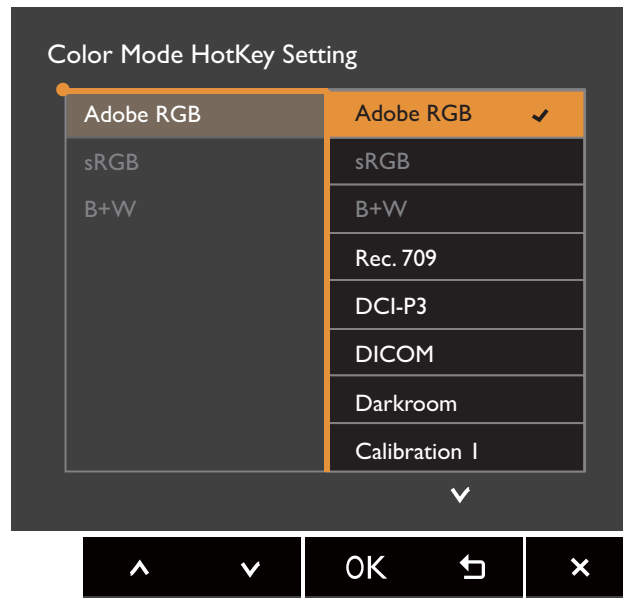

Alternatively, you can customize the Color Mode HotKey by selecting  (Menu) > System > Color Mode HotKey.

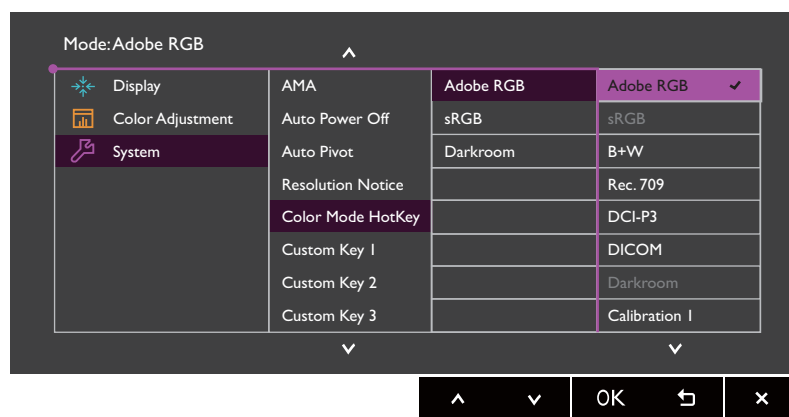

Customizing the hot keys

There are 3 custom keys (indicated as ② / ③ / ④ on [page 33](#)) performing as hot keys to provide direct access to pre-defined functions. You can change the default setting and designate different functions for these keys.

- Press any of the control keys to bring up the hot key menu. Select  (Menu) to access the main menu.
- Go to **System**.
- Select the custom key you want to change.
- In the sub menu, select a function that can be accessed by this key. A pop-up message will appear, showing that the setup is complete.

Adjusting the display color

To adjust the display color, you can do one of the following:

- Press the  key.
- Apply the standard color setting from **Color Adjustment > Color Mode**.
- Change the display and color settings manually from the related OSD menus. Depending on the **Color Mode** you just set, the available options for color adjustment may vary. See [Available menu options for each color mode on page 45](#) for more information. Once the adjustment is done, you can save the customized settings from **Color Adjustment > Save Color Settings**.
- Use a colorimeter (purchased separately) to work with the provided software named **Palette Master Element** and optimized the display color. Visit the website for software download and more information (Palette Master Element How-to-Use Guide).
The access: www.BenQ.com > Purchased model > the **Download** or **Support** tab
- To apply the calibrated result, go to **Color Adjustment > Color Mode > Calibration 1 / Calibration 2 / Calibration 3**.

Adjusting display mode

To display images of aspect ratio other than 16:10 and size other than the panel size of your purchased model, you can adjust the display mode on the monitor.

1. Press any of the control keys to bring up the hot key menu. Select  (**Menu**) to access the main menu.
2. Go to **Display** and **Aspect Ratio**.
3. Select an appropriate display mode. The setting will take effect immediately.

Choosing an appropriate color mode

Your monitor provides various color modes that are suitable for different types of images. See [Color Mode on page 41](#) for all the available color modes.

- Press the  key. See [Working with the Color Mode HotKey on page 35](#) for details.
- Go to **Color Adjustment** and **Color Mode** for a desired color mode.

Navigating the main menu

You can use the OSD (On Screen Display) menu to adjust all the settings on your monitor.

Press any of the control keys to bring up the hot key menu. Select  (**Menu**) to access the main menu. See [Basic menu operation on page 33](#) for details.

Available menu options may vary depending on the input sources, functions and settings. Menu options that are not available will become grayed out. And keys that are not available will be disabled and the corresponding OSD icons will disappear. For models without certain functions, their settings and related items will not appear on the menu.



The OSD menu languages may differ from the product supplied to your region, see [Language on page 47](#) under **System** and **OSD Settings** for more details.









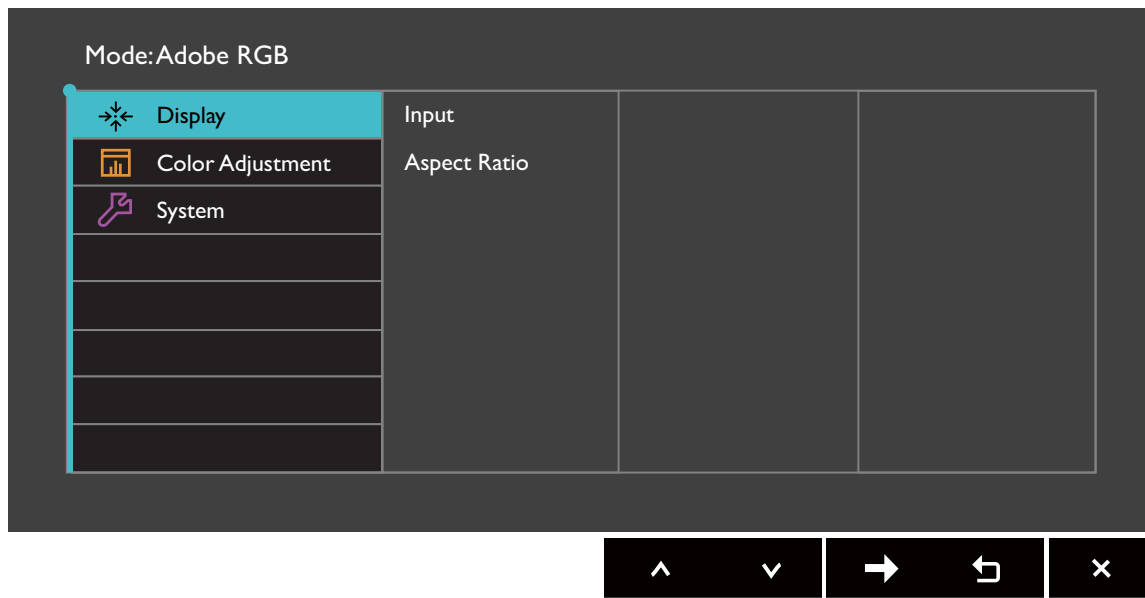

For more information on each menu, please refer to the following pages:

- [Display menu on page 39](#)
- [Color Adjustment menu on page 41](#)
- [System menu on page 46](#)

Display menu

Available menu options may vary depending on the input sources, functions and settings. Menu options that are not available will become grayed out. And keys that are not available will be disabled and the corresponding OSD icons will disappear. For models without certain functions, their settings and related items will not appear on the menu.



1. Select  (**Menu**) from the hot key menu.
2. Use  or  to select **Display**.
3. Select  to go to a sub menu, and then use  or  to select a menu item.
4. Use  or  to make adjustments, or use **OK** to make selection.
5. To return to the previous menu, select .
6. To exit the menu, select .









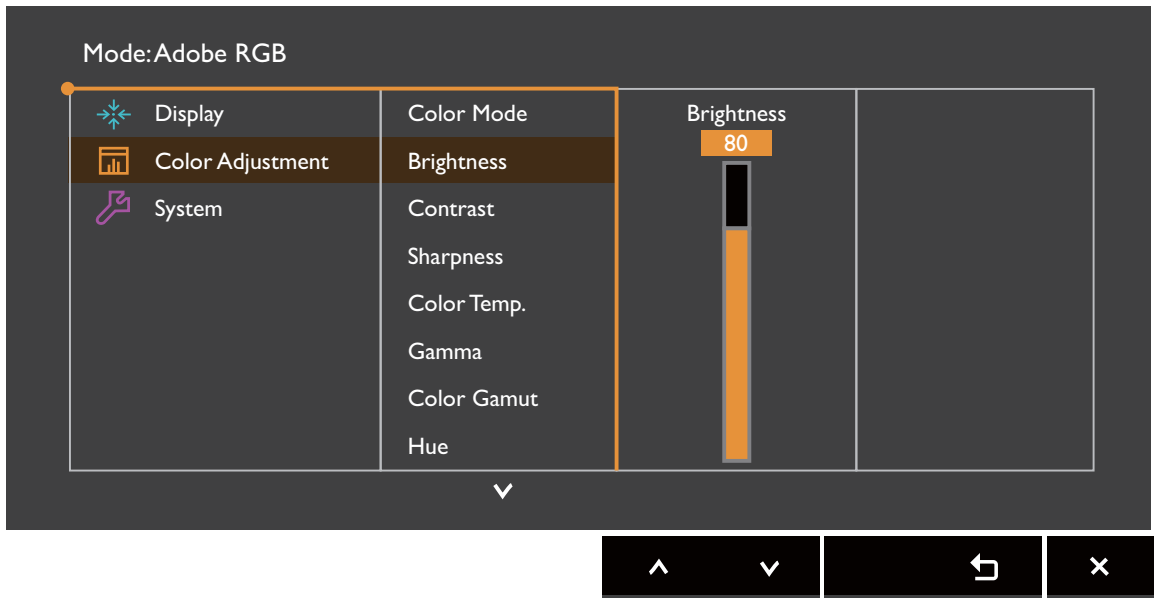

Item	Function	Range
Input	Use this to change the input to that appropriate to your video cable connection type.	<ul style="list-style-type: none"> • HDMI • DP • DVI

Item	Function		Range
Aspect Ratio	This feature is provided to allow aspect ratios other than 16:10 to be displayed without geometric distortion.		
	Full	Scales the input image to fill the screen. Ideal for 16:10 aspect images.	
	Aspect	The input image is displayed without geometric distortion filling as much of the display as possible.	
	1:1	Displays the input image in its native resolution without scaling.	

Color Adjustment menu



Available menu options may vary depending on the input sources, functions and settings. Menu options that are not available will become grayed out. And keys that are not available will be disabled and the corresponding OSD icons will disappear. For models without certain functions, their settings and related items will not appear on the menu.



1. Select  (**Menu**) from the hot key menu.
2. Use  or  to select **Color Adjustment**.
3. Select  to go to a sub menu, and then use  or  to select a menu item.
4. Use  or  to make adjustments, or use  to make selection.
5. To return to the previous menu, select .
6. To exit the menu, select .

Item	Function		Range
Color Mode	Select a color mode that best suits the type of images shown on the screen.		
	Adobe RGB	For better color matching representation with Adobe® RGB compatible peripherals.	
	sRGB	For better color matching representation with sRGB compatible peripherals.	
	B+W	Applies a black and white theme.	<ul style="list-style-type: none"> • Level 1 • Level 2 • Level 3

Item	Function		Range
	Rec. 709	For better color matching representation with Standard Rec. 709.	
	DCI-P3	For better color matching representation with Standard DCI-P3.	
	DICOM	<p>For viewing DICOM images. It is recommended for displaying medical images.</p>  <p>DICOM as the abbreviation of Digital Imaging and Communications in Medicine is a standard for handling, storing, printing, and transmitting medical images.</p>	
	Darkroom	For image editing and viewing in a post-processing environment with a dim light. This mode enhances the sharpness and clarity of shades and shows more details.	
	Calibration 1	Applies the calibration result optimized by the provided calibration software named Palette Master Element and your colorimeter (purchased separately). Visit the website for software download and more information (Palette Master Element How-to-Use Guide). The access: www.BenQ.com > Purchased model > the Download or Support tab	
	Calibration 2		
	Calibration 3		
	Custom 1	Applies a combination of color settings defined by users.	
	Custom 2		
Brightness	Adjusts the balance between light and dark shades.		0 to 100
Contrast	Adjusts the degree of difference between darkness and lightness.		0 to 100
Sharpness	Adjusts the clarity and visibility of the edges of the subjects in the image.		0 to 10

Item	Function		Range
Color Temp.	5000K	Applies a color tint (cool or warm) to the image. Color temperature is measured in K (Kelvin) degrees. The display becomes reddish if the color temperature is low, and becomes bluish if the color temperature is high.  Some color gradations may not be displayed well if this the setting has been adjusted.	
	6500K		
	9300K		
	Custom	Allows to adjust color temperature by 100K.	5000K ~ 9300K
	User Define	The blend of the Red, Green and Blue primary colors can be altered to change the color tint of the image. Go to the succeeding R (red), G (green), and B (blue) menus to change the settings. Decreasing one or more of the colors will reduce their respective influence on the color tint of the image. (e.g. if you reduce the Blue level the image will gradually take on a yellowish tint. If you reduce Green, the image will become a magenta tint.)	<ul style="list-style-type: none"> • R (0~100) • G (0~100) • B (0~100)
Gamma	Adjusts the tone luminance.		<ul style="list-style-type: none"> • 1.6 • 1.8 • 2.0 • 2.2 • 2.4 • 2.6
Color Gamut (not available when Color Mode is set to Adobe RGB , sRGB , Rec. 709 , or DPI-C3)	Adobe RGB	Suitable for Adobe® RGB compatible peripherals.	
	sRGB	Suitable for sRGB compatible peripherals.	
	Rec. 709	For better color matching representation with Standard Rec. 709.	
	DCI-P3	For better color matching representation with Standard DCI-P3.	
Hue	Adjusts the degree of how we perceive colors.  Some color gradations may not be displayed well if this the setting has been adjusted.		<ul style="list-style-type: none"> • R • G • B • C • M • Y

Item	Function	Range
Saturation	Adjusts the purity degree of colors.  Some color gradations may not be displayed well if this the setting has been adjusted.	<ul style="list-style-type: none"> •R •G •B •C •M •Y
Black Level	Adjusts the luminance of the dark areas in an image.	0~10
Save Color Settings	Saves a new set of customized color settings.	<ul style="list-style-type: none"> • Custom Mode 1 • Custom Mode 2
Reset Color	Resets the custom color settings to the factory defaults.	<ul style="list-style-type: none"> • YES • NO

Available menu options for each color mode

Depending on the **Color Mode** you just set, the available options for color adjustment may vary. Color modes and the available display options are as follows:

SW240		Settings							
Color Mode	Brightness	Contrast	Sharpness	Color Temp.	Gamma	Color Gamut	Hue	Saturation	Black Level
Adobe RGB	V	V	V	5000K / 6500K	2.2	Adobe RGB	N/A	N/A	V
sRGB	V	V	V	5000K / 6500K	2.2	sRGB	N/A	N/A	V
B+W (*)	V	V	V	N/A	N/A	N/A	N/A	N/A	N/A
Rec. 709	V	V	V	6500K	2.2 / 2.4	Rec. 709	N/A	N/A	V
DCI-P3	V	V	V	x=0.314, y=0.351	2.2 / 2.4 / 2.6	DCI-P3	N/A	N/A	V
DICOM	V	V	V	7500K	N/A	Panel Native	N/A	N/A	N/A
Darkroom	V	V	V	N/A	N/A	Adobe RGB / sRGB	N/A	N/A	N/A
Calibration 1	N/A	N/A	V	N/A	N/A	N/A	V	V	N/A
Calibration 2	N/A	N/A	V	N/A	N/A	N/A	V	V	N/A
Calibration 3	N/A	N/A	V	N/A	N/A	N/A	V	V	N/A
Custom 1	V	V	V	V	V	V	V	V	V
Custom 2	V	V	V	V	V	V	V	V	V

• V: all options are available for adjustment.

N/A: all options are not available for adjustment.









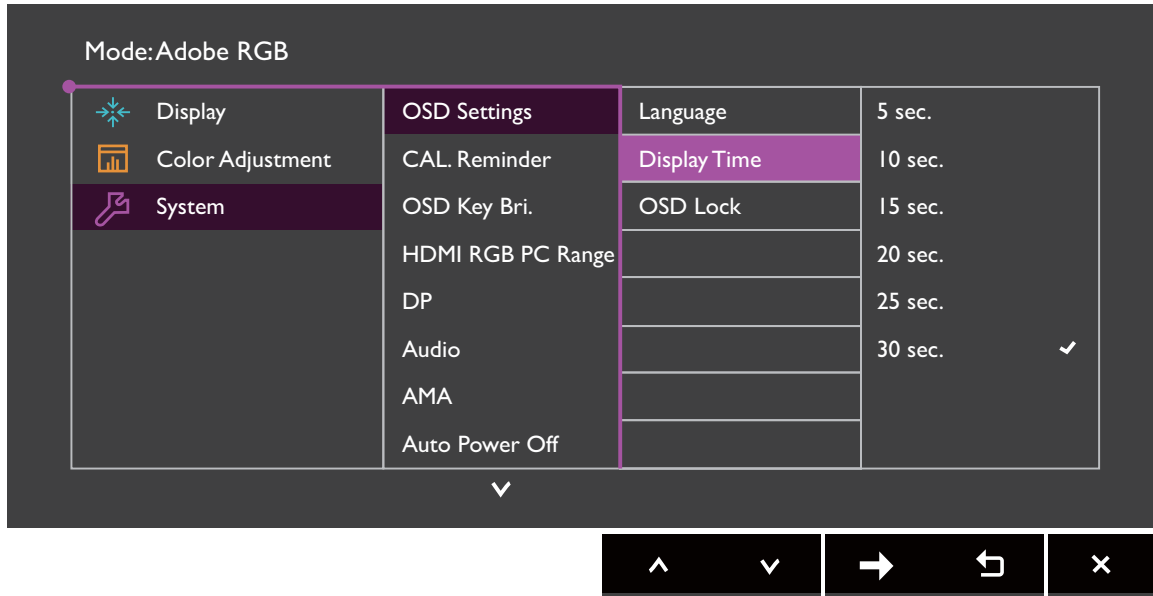

• *: 3 levels are provided for adjustment.





System menu

Available menu options may vary depending on the input sources, functions and settings. Menu options that are not available will become grayed out. And keys that are not available will be disabled and the corresponding OSD icons will disappear. For models without certain functions, their settings and related items will not appear on the menu.



1. Select  (**Menu**) from the hot key menu.
2. Use  or  to select **System**.
3. Select  to go to a sub menu, and then use  or  to select a menu item.
4. Use  or  to make adjustments, or use  to make selection.
5. To return to the previous menu, select .
6. To exit the menu, select .

Item	Function		Range
OSD Settings	Language	Sets the OSD menu language.  The language options displayed on your OSD may differ from those shown on the right, depending on the product supplied in your region.	<ul style="list-style-type: none"> • English • Français • Deutsch • Italiano • Español • Polski • Český • Magyar • Română • Nederlands • Русский • Svenska • Português • العربية • 日本語 • 한국어 • 繁體中文 • 简体中文
	Display Time	Adjusts the display time of the OSD menu.	<ul style="list-style-type: none"> • 5 sec. • 10 sec. • 15 sec. • 20 sec. • 25 sec. • 30 sec.
	OSD Lock	Prevents all the monitor settings from being accidentally changed. When this function is activated, the OSD controls and hotkey operations will be disabled.  To unlock the OSD controls, press and hold any key for 10 seconds.	
CAL. Reminder	Sets to remind you when monitor calibration is recommended. When the monitor is in use, the used time is automatically calculated by a built-in timer.		<ul style="list-style-type: none"> • ON • OFF
OSD Key Bri.	Adjusts the LED indicator's brightness of the power key.		
HDMI RGB PC Range	Determines the range of color scales. Select an option that matches the RGB range setting on the connected HDMI device.		<ul style="list-style-type: none"> • Auto Detect • RGB (0~255) • RGB (16~235)



Item	Function		Range
DP	Selects an appropriate DP standard for data transmission.		<ul style="list-style-type: none"> • 1.1 • 1.2
Audio	Volume	Adjusts the audio volume.	0~100
	Mute	Mutes the audio input.	<ul style="list-style-type: none"> • ON • OFF
AMA	Improves the gray level response time of the LCD panel.		<ul style="list-style-type: none"> • ON • OFF
Auto Power Off	Sets the time to power off the monitor automatically in power saving mode.		<ul style="list-style-type: none"> • OFF • 10 min. • 20 min. • 30 min.
Auto Pivot	Sets to rotate the OSD menu with the monitor.		<ul style="list-style-type: none"> • ON • OFF
Resolution Notice	Sets whether to display the resolution notice of the recommended resolution when a new input source is detected by the monitor.		<ul style="list-style-type: none"> • ON • OFF
Color Mode HotKey	Sets to customize the Color Mode HotKey.		<ul style="list-style-type: none"> • Adobe RGB • sRGB • B+W • Rec. 709 • DCI-P3 • DICOM • Darkroom • Calibration 1 • Calibration 2 • Calibration 3 • Custom 1 • Custom 2
Custom Key 1	Sets the function to be accessed by custom key 1.		<ul style="list-style-type: none"> • Brightness • Contrast • Input • Color Mode • Color Temp. • Gamma • Color Gamut
Custom Key 2	Sets the function to be accessed by custom key 2.		
Custom Key 3	Sets the function to be accessed by custom key 3.		





Item	Function	Range
DDC/CI	<p>Allows the monitor settings to be set through the software on the PC.</p>  <p>DDC/CI, short for Display Data Channel/Command Interface, which was developed by Video Electronics Standards Association (VESA). DDC/CI capability allows monitor controls to be sent via the software for remote diagnostics.</p>	<ul style="list-style-type: none"> • ON • OFF
Information	Displays the current monitor property settings.	<ul style="list-style-type: none"> • Input • Current Resolution • Optimum Resolution (best with the monitor) • Model Name
Reset All	Resets all mode, color and geometry settings to the factory default values.	<ul style="list-style-type: none"> • YES • NO



Troubleshooting

Frequently asked questions (FAQ)





Imaging

-  The image is blurred.
-  • Read the instructions on the link "**Adjusting the Screen Resolution**" on the CD, and then select the correct resolution, refresh rate and make adjustments based on these instructions.

 - If a VGA extension cable is used, remove the extension cable for the test. Is the image now in focus? If not, optimize the image by working through the instructions in the "**Adjusting the refresh rate**" section on the link "**Adjusting the Screen Resolution**". It is normal for blurring to occur due to conduction losses in extension cables. You can minimize these losses by using an extension cable with better conduction quality or with a built-in booster.
-  Does the blurring only occur at resolutions lower than the native (maximum) resolution?
-  Read the instructions on the link "**Adjusting the Screen Resolution**" on the CD. Select the native resolution.
-  Pixel errors can be seen.
-  One of several pixels is permanently black, one or more pixels are permanently white, one or more pixels are permanently red, green, blue or another color.
-  • Clean the LCD screen.

 - Cycle power on-off.
 - These are pixels that are permanently on or off and is a natural defect that occurs in LCD technology.
-  The image has a faulty coloration.
-  It has a yellow, blue or pink appearance.

Go to **Picture** and **Reset Color**, and then choose **YES** to reset the color settings to the factory defaults.

If the image is still not correct and the OSD also has faulty coloration, this means one of the three primary colors is missing in the signal input. Now check the signal cable connectors. If any pin is bent or broken off, please contact your dealer to get necessary support.
-  The image is distorted, flashes or flickers.
-  Read the instructions on the link "**Adjusting the Screen Resolution**" on the CD, and then select the correct resolution, refresh rate and make adjustments based on these instructions.
-  You are running the monitor at its native resolution, but the image is still distorted.
-  Images from different input sources may appear distorted or stretched on the monitor running at its native resolution. To have the optimal display performance of each type of input sources, you can use the **Display Mode** function to set a proper aspect ratio for the input sources. See [Aspect Ratio on page 40](#) for details.

- ❓ The image is displaced in one direction.
- ✅ Read the instructions on the link "**Adjusting the Screen Resolution**" on the CD, and then select the correct resolution, refresh rate and make adjustments based on these instructions.
- ❓ Faint shadow from the static image displayed is visible on the screen.
- ✅
 - Activate the power management function to let your computer and monitor go into a low power "sleep" mode when not actively in use.
 - Use a screensaver to prevent the occurrence of image retention.

Power LED indicator

- ❓ The LED indicator is solid white or flashing white.
- ✅
 - If the LED lights up in solid white, the monitor is powered on.
 - If the LED is illuminated in white and there is a message **Out of Range** on the screen, this means you are using a display mode that this monitor does not support, please change the setting to one of the supported mode. Please read the "**Preset display modes**" section from the link "**Adjusting the Screen Resolution**".
 - If the LED is illuminated in flashing white, the power management mode is active. Press any button on the computer keyboard or move the mouse. If that does not help, check the signal cable connectors. If any pin is bent or broken off, please contact your dealer to get necessary support.
 - If the LED is off, check the power supply mains socket, the external power supply and the mains switch.

OSD controls

- ❓ The OSD controls are inaccessible.
- ✅ To unlock the OSD controls when it is preset to be locked, press and hold any key for 10 seconds.





OSD messages

- ❓ A message **Out of Range** on the screen during computer boot up process.
- ✅ If there is a message **Out of Range** on the screen during computer boot up process, this means computer compatibility caused by operating system or graphic card. The system will adjust the refresh rate automatically. Just wait until the operating system is launched.

Audio

- ❓ No sound can be heard from the built-in speakers. (selected models only)
- ✅
 - Check whether the desired cable to input audio signals is properly connected. See [Connect the audio cable. on page 12](#) for details.
 - Increase the volume (volume may be muted or too low).
 - Remove your headphone and/or external speakers. (If they are connected to the monitor, the built-in speakers are automatically muted.)

 No sound can be heard from the connected external speakers.

-  • Remove your headphone (if the headphone is connected to the monitor).
-  • Check whether the headphone jack is properly connected.
-  • If the external speakers are USB-powered, check whether the USB connection is OK.
-  • Increase the volume (volume may be muted or too low) on the external speakers.

Need more help?

If your problems remain after checking this manual, please contact your place of purchase or visit the local website from www.BenQ.com for more support and local customer service.