

1. Disassembly Procedures:

S1

Remove 12pcs carton locks, then use a proper tool to open the carton, and then uplift the top paper-box slowly. Remove EPS-Top(right and left) with PC box and accessories box(1pcs Type-C cable, 1pcs HDMI cable, 1pcs DP cable, 1pcs USB cable, 1pcs EU+USA cable, battery, remote control, 1pcs cable lock, 2pcs stylus, stylus magnet, 2pcs tips of pen, the CD and user's manual).

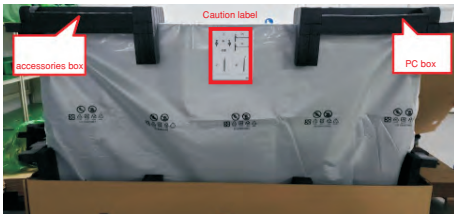

Take out 5 bags of desiccant from the EPS-bottom. Remove the PE bag from top to bottom. Use a machine jip to take out the whole monitor from the EPS-bottom, and then put the monitor on ESD protection foam.

S2



S3

Use a screwdriver to remove 16pcs screws for releasing the handles. (Torque:15±0.5kgf) Remove 6pcs screws for unlocking IO hing with rear cover. (Torque:3±0.3kgf) Remove 69pcs screws for unlocking the rear cover(Torque: 3±0.3kgf).



S4

Remove the handles and rear cover, then use a screwdriver to remove 7pcs screws for releasing the PC box.(Torque: 4.5±0.3kgf)

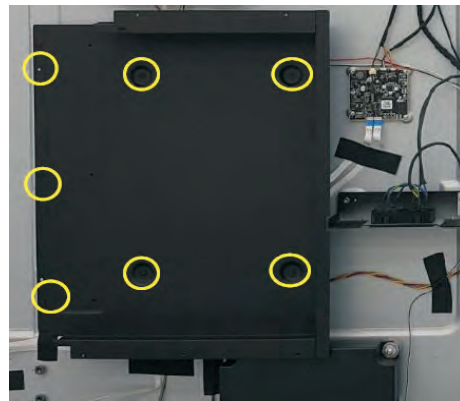

S5

Paste 1pcs for fixing the cable as the picture below shown. Remove 16pcs acetate tapes(size: 80mm) and 1pcs acetate tapes(size: 60mm) for unfixing the cables as the picture below shown.

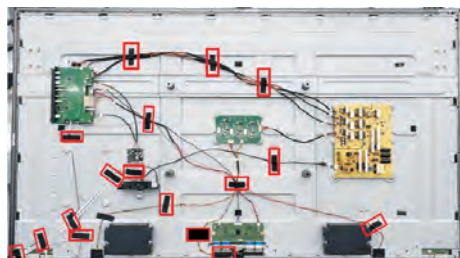

S6

Tear off 2pcs conductive tape for releasing main board, USB board and LVDS cable. Remove 3pcs shading fabric tapes on the holes of L/B (marked green). Remove 4pcs acetate tapes on the holes of the back bracket. (marked yellow)

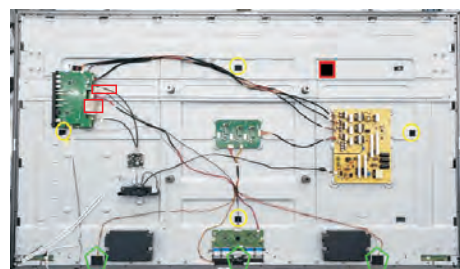

S7

Disconnect all the cables as the picture below shown.
Use a screwdriver to remove 2pcs screws for unlocking AC power outlet. (Torque: $4.5\pm 0.5\text{kgf}$)

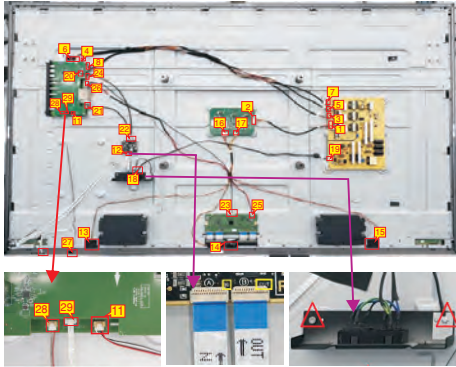
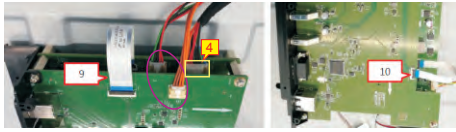

S8

Use a screwdriver to remove 8pcs screws for unlocking the two speakers. (Torque: $4.5\text{kgf}\pm 0.5$)

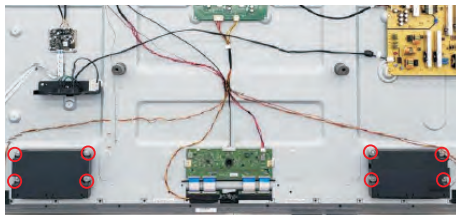

Use a Hex-head screwdriver to remove 2pcs screws for unlocking VGA connectors. (Torque: $4.5\text{kgf}\pm 0.5$)

S9

Use a screwdriver to remove 12pcs screws for unlocking the USB board, IO holder and main board, remove 17pcs screws for locking the power board, driver board, touch board and T-Con board. (Torque: $4.5\text{kgf}\pm 0.3$) Disconnect all the FFC cables away from the T-con board.

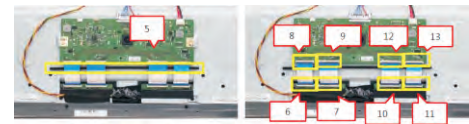
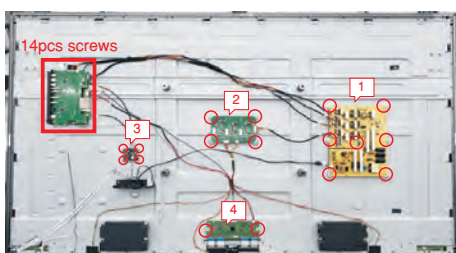
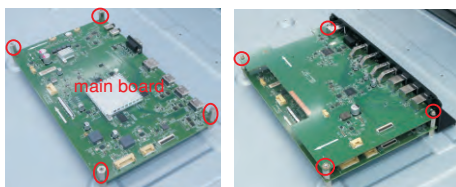

S10

Use a screwdriver to remove 40pcs screws (left: 10pcs, right: 10pcs, top: 10pcs, bottom: 10pcs) for unlocking 4pcs strips. (Torque: $4.5\pm 0.3\text{kgf}$)

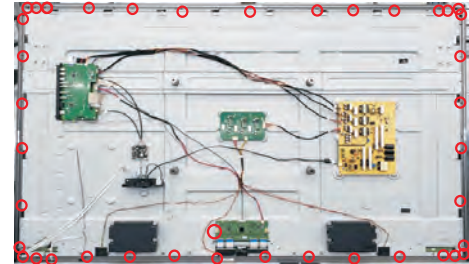

S11

Use a screwdriver to remove 2pcs screws for unlocking the key board and the holder with strip. (Torque: $2\pm 0.3\text{kgf}$)

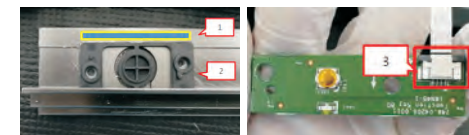
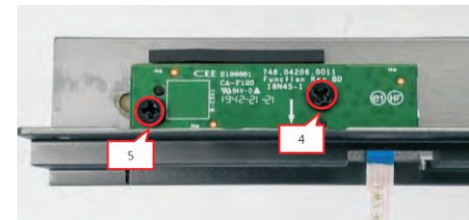

S12

Use a screwdriver to remove 38pcs screws for unlocking the front bezels (top, left, right, bottom). (Torque: $3\pm 0.3\text{kgf}$)



S13

Use a screwdriver to remove 15pcs screws for unlocking H-beam with the assembled unit, and then remove the H-Beam. (Torque: $4.5\pm 0.5\text{kgf}$)

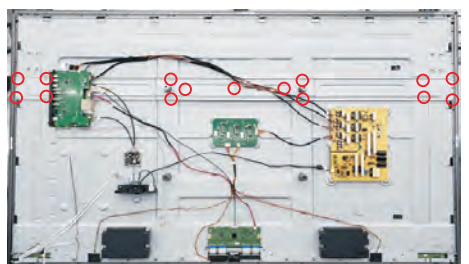

S14

Disconnect the touch cable and FFC cables. Use a screwdriver to remove 24pcs(16+8) screws(Torque: $4.5 \pm 0.5\text{kgf}$) for unlocking the ED holder with the assembled unit.



Remove all the bezel and strips and put them on a protective cushion. Open the IR board cover, then use a screwdriver to remove 2pcs screws for unlocking the IR board and holder with front bezel, then use a screwdriver to remove 2pcs screws for unlocking the light pipe with front bezel. (Torque: $3 \pm 0.3\text{kgf}$)

S15



S16

Tear off 16pcs conductive foams on the specific position of the COF of the SB, then tear off all the tape and foams, and release the O/C SB away from the back bracket.

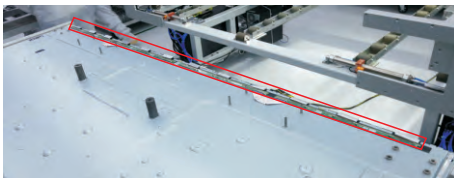

S17

Turn over the panel module with the bracket for screen faced up. Use a thin film(such as Prism film) to disassemble the O/C with glass carefully, then remove the O/C with glass and put then on a protective cushion.

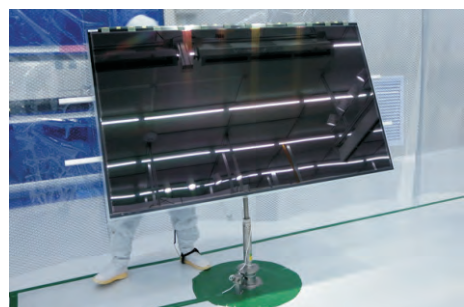
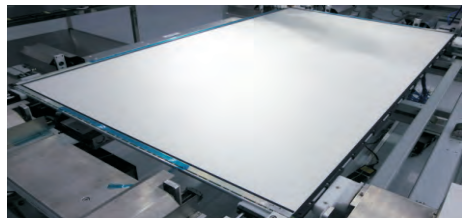
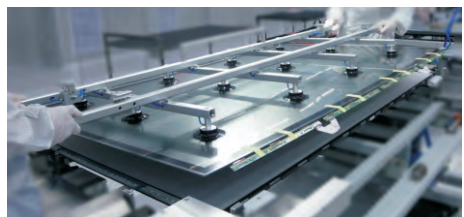
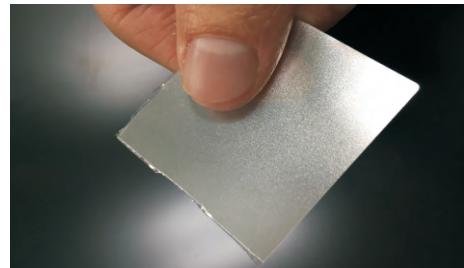
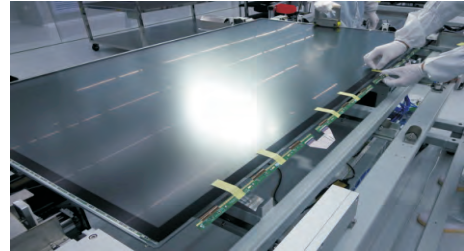

S18

Use a tripper to lift up the unit, then use a screwdriver to remove 17pcs screws for unlocking the ED unit, then use the tripper to put down the unit. (Torque: 3.5±0.3kgf)

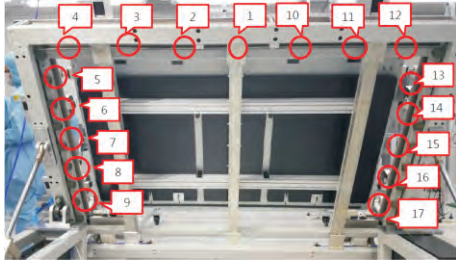

Use a ED holder fixture to fix the ED holders, then tear off all the tapes and rubbers, then lift up the ED holder unit for removing the ED unit, and then put the unit on a protective cushion.

S19



S20

Use a screwdriver to remove 8pcs screws for unlocking the two bracket with the bottom ED holder. (Torque: 3±0.3kgf)

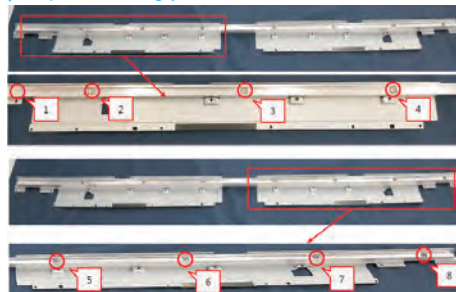

S21

Tear off 16pcs acetate tapes, then use a screwdriver to remove 17pcs screws for unlocking the bottom-middle bezel. (Torque: 3.5±0.3kgf)

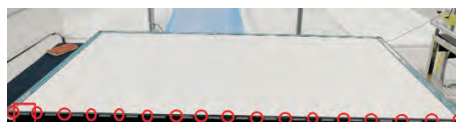

S22

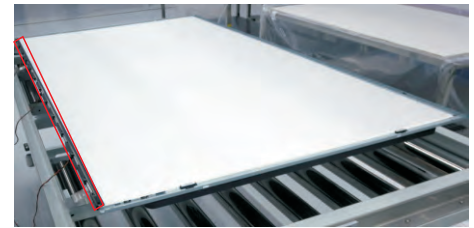

Remove 1pcs DEBF film, 1pcs Diffuser film, 1pcs LGP, 1pcs Reflector film away from the back bracket.

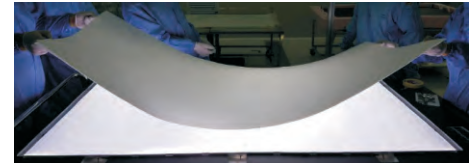

S23

Tear off 2pcs rubber on the left and right side of back bracket. Use a screwdriver to remove 33(25+8)pcs screws for unlocking the L/B heat sink with the back bracket. (Torque: 5±0.5kgf)

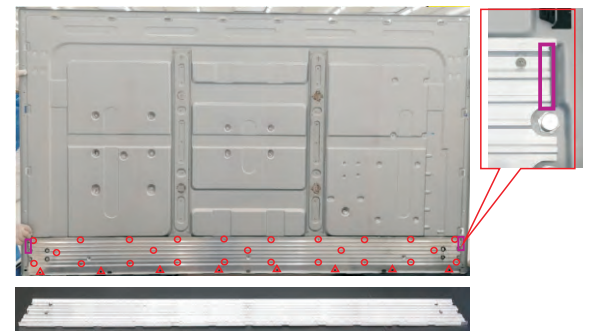

S24

Use a screwdriver to remove 18pcs screws for unlocking the two VESA brackets with back bracket. (Torque: 5±0.5kgf)



S25

Remove electrolyte capacitors (red mark) from printed circuit boards.

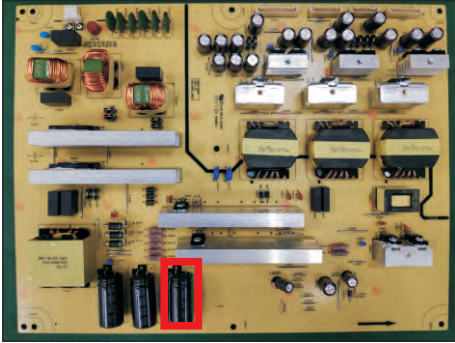

S25-1 Cut the glue between bulk cap. and PCB with a knife.

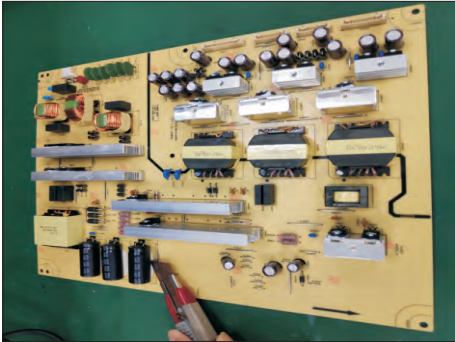

S25-2 Ensure cutting path within the glue, don't touch bulk cap. or PCB.

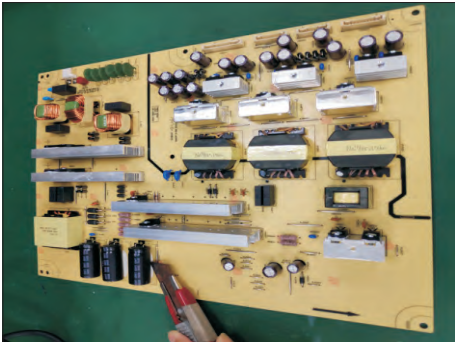

S25-3 Cut into the bottom of bulk cap. and pullit up carefully.



S25-4 Take out bulk cap. pin solder with soldering iron and absorber.



S25-5 Lift the bulk cap. up and away from the PCB.

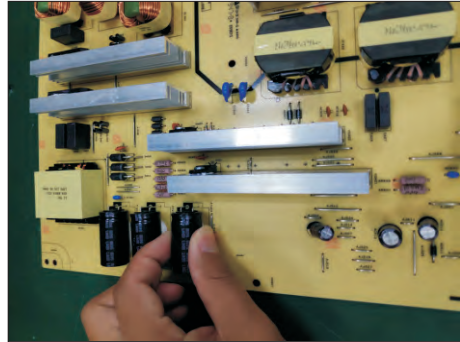

2. Product material information

The following substances, preparations, or components should be disposed of or recovered separately from other WEEE in compliance with Article 4 of EU Council Directive 75/442/EEC.

Capacitors / condensers (containing PCB/PCT)	No used
Mercury containing components	No used
Batteries	No used
Printed circuit boards (with a surface greater than 10 square cm)	Product has printed circuit boards (with a surface greater than 10 square cm)
Component contain toner, ink and liquids	No used
Plastic containing BFR	No used
Component and waste contain asbestos	No used
CRT	No used
Component contain CFC, HCFC, HFC and HC	No used
Gas discharge lamps	No used
LCD display > 100 cm ²	Product has an LCD greater than 100 cm ²
External electric cable	Product has external cables
Component contain refractory ceramic fibers	No used
Component contain radio-active substances	No used
Electrolyte capacitors (height > 25mm, diameter > 25mm)	Product has electrolyte capacitors (height > 25mm, diameter > 25mm)

3. Tools Required

List the type and size of the tools that would typically can be used to disassemble the product to a point where components and materials requiring selective treatment can be removed.

Tool Description:

- Screwdriver (Phillip head) #1
- Screwdriver (Phillip head) #2
- Penknife
- Soldering iron and absorber