

OWNER'S MANUAL LED LCD Monitor (LED Monitor*)

*LG LED Monitors are LCD Monitors with LED Backlighting.

Please read this manual carefully before operating your set and retain it for future reference.

LED LCD MONITOR MODEL

22MK600M

24MK600M

27MK600M

27MK60TM

CONTENTS

LICENSE ----- 3

ASSEMBLING AND PREPARING - 4

- Product Components----- 4
- Supported Drivers and Software ----- 5
- Component and Button Description ----- 6
 - How to Use the Joystick Button
 - Input Connector
- Moving and Lifting the Monitor----- 8
- Setting up the Monitor set ----- 9
 - Assembling the Stand
 - Mounting on a table
 - Mounting on a wall

USING THE MONITOR SET----- 14

- Connecting to a PC----- 14
 - D-SUB connection
 - HDMI connection
- Connecting to AV Devices ----- 15
 - HDMI connection
- Connecting Peripherals----- 15
 - Connecting Headphones

CUSTOMIZING SETTINGS ----- 16

TROUBLESHOOTING ----- 21

SPECIFICATIONS ----- 22

- Preset Modes (Resolution) -----28
- Beep Guide -----30

LICENSE

Each model has different licenses. Visit www.lg.com for more information on the license.



The terms HDMI and HDMI High-Definition Multimedia Interface, and the HDMI Logo are trademarks or registered trademarks of HDMI Licensing Administrator, Inc.

The following content is only applied to the monitor which is sold in Europe market and which needs to meet the ErP Directive:

* This monitor is set to be turned off automatically in 4 hours after you turned on display if there is no adjustment to display.

* To disable this setting, change the option to `Off` in the OSD "Automatic Standby" menu.

ASSEMBLING AND PREPARING

Product Components

Please check whether all the components are included in the box before using the product. If there are missing components, contact the retail store where you purchased the product. Note that the product and components may look different from those shown here.



CD / Card
(Depending on the country)

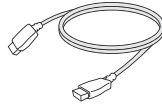

HDMI Cable
(Depending on the country)



D-SUB Cable
(Depending on the country)



Power Cord
(Depending on the country)

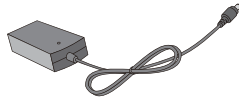

AC-DC Adapter

or



AC-DC Adapter
(Depending on the country)

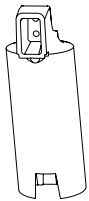

Stand Body

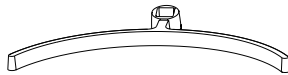

Stand Base



Screw Cover

22MK600M

24MK600M

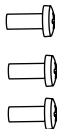

3 Screws

27MK600M

27MK60TM



2 Screws

**CAUTION**

- Always use genuine components to ensure safety and product performance.
- The product warranty will not cover damage or injury caused by the use of counterfeit components.
- It is recommend that use the supplied components.
- If you use generic cables not certified by LG, the screen may not display or there may be image noises.

**NOTE**

- Note that the components may look different from those shown here.
- Without prior notice, all information and specifications in this manual are subject to change to improve the performance of the product.
- To purchase optional accessories, visit an electronics store or online shopping site or contact the retail store where you purchased the product.

Supported Drivers and Software

You can download and install the latest version from the LGE website (www.lg.com).

Drivers and Software	Installation Priority	22MK600M 24MK600M 27MK600M 27MK60TM
Monitor Driver	Recommended	○
OnScreen Control	Recommended	○



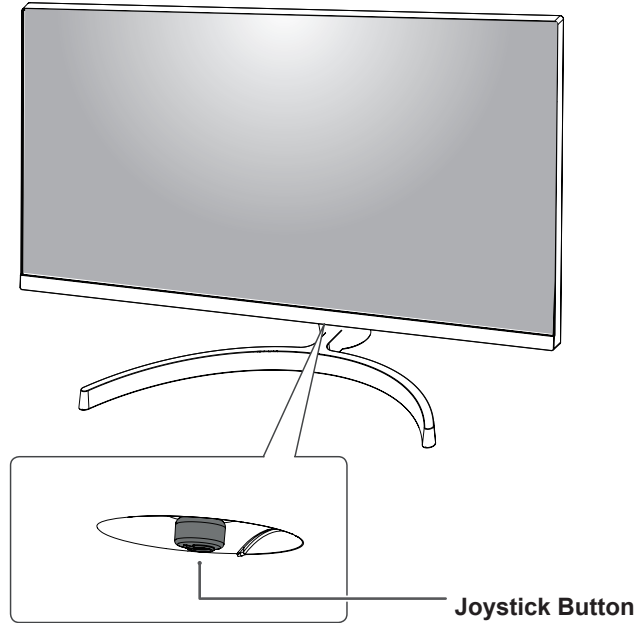

Component and Button Description

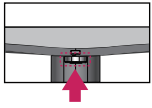

How to Use the Joystick Button

You can easily control the functions of the monitor by pressing the joystick button or moving it left/right with your finger.

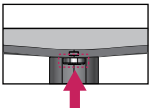
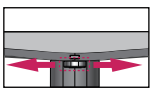
Basic Functions

		Power on	Press the joystick button once with your finger to turn on the monitor.
		Power off	Press and hold the joystick button once with your finger to turn off the monitor.
		Volume Control	You can control the volume by moving the joystick button left/right. (for HDMI only)

NOTE

- The joystick button is located at the bottom of the monitor.

Input Connector

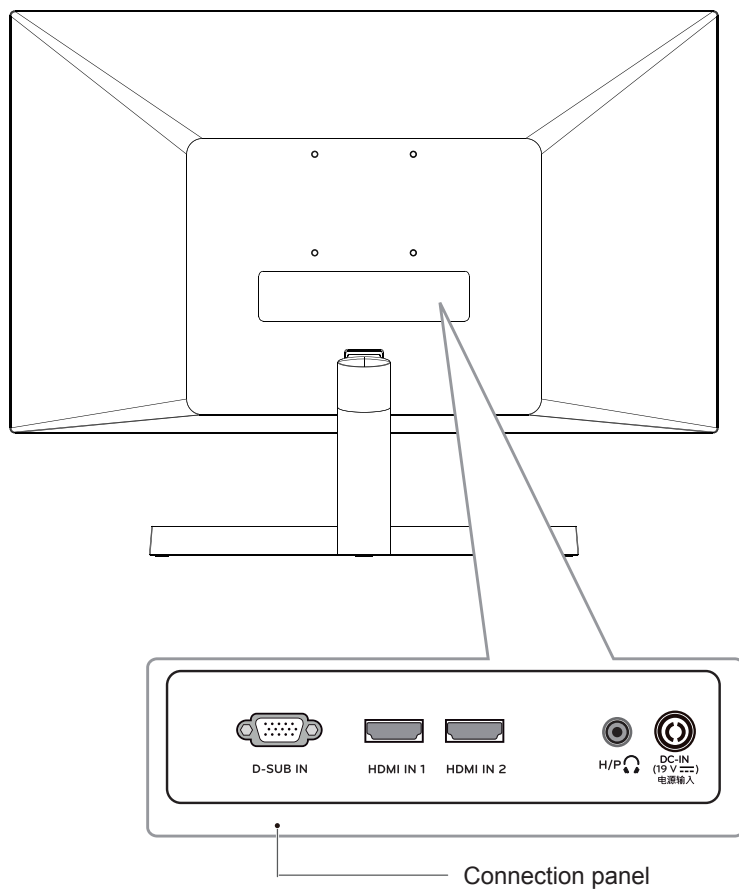

Moving and Lifting the Monitor

When moving or lifting the monitor, follow these instructions to prevent the monitor from being scratched or damaged and to ensure safe transportation regardless of its shape or size.

- It is advisable to place the monitor in the original box or packing material before attempting to move it.
- Before moving or lifting the monitor, disconnect the power cord and all cables.
- Hold the top and bottom of the monitor frame firmly. Do not hold the panel itself.

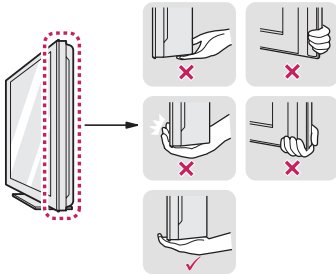

- When holding the monitor, the screen should face away from you to prevent it being scratched.



- When moving the monitor, avoid any strong shock or vibrations to the product.
- When moving the monitor, keep it upright, never turn the monitor on its side or tilt it sideways.

CAUTION

- As far as possible, avoid touching the monitor screen. This may result in damage to the screen or some of the pixels used to create images.

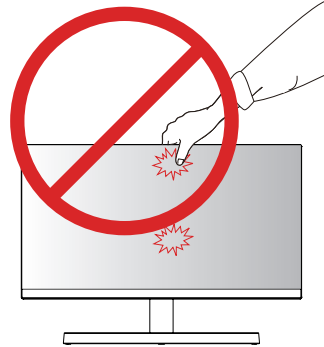

- If you use the monitor panel without the stand base, its joystick button may cause the monitor to become unstable and fall, resulting in damage to the monitor or human injury. In addition, this may cause the joystick button to malfunction.

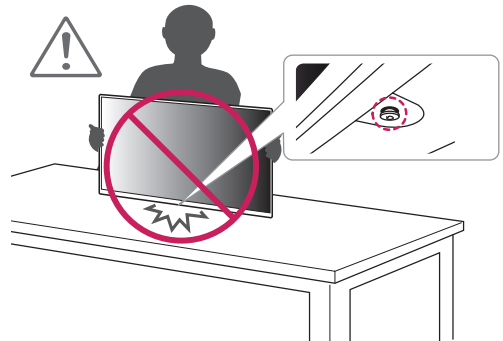

Setting up the Monitor set

Assembling the Stand

1

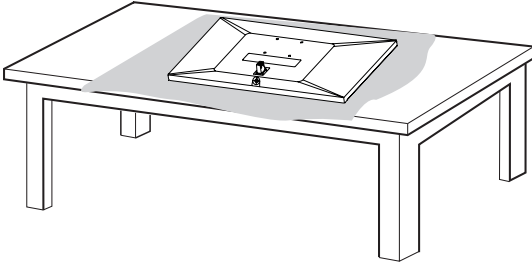

CAUTION

- To protect the screen from scratches, cover the surface with a soft cloth.

2

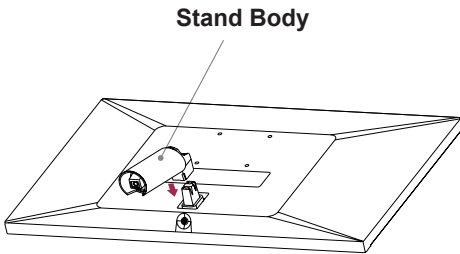

3

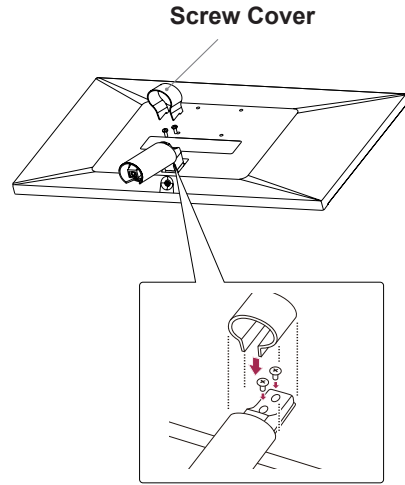

4

22MK600M

24MK600M

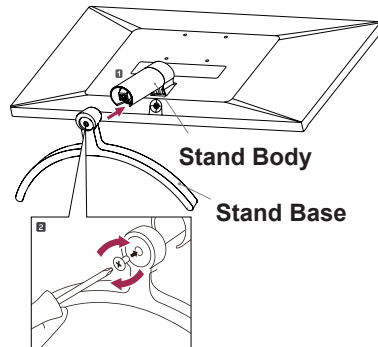

27MK600M

27MK60TM

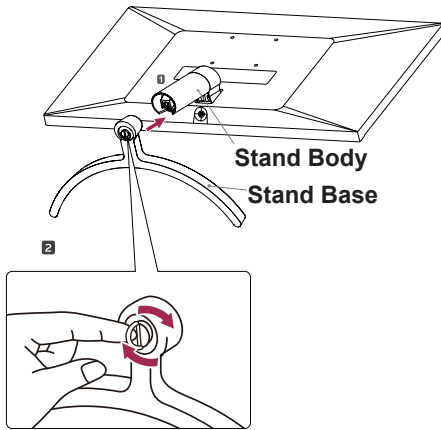

! WARNING

- To avoid injury to the fingers and foot when Assembling the Stand Body and Base, you should hold the Base for better stability.

! CAUTION

- Illustrations in this document represent typical procedures, so they may look different from the actual product.
- Do not carry the monitor upside down by just holding the stand base. This may cause the monitor to fall off the stand and could result in personal injury.
- When lifting or moving the monitor, do not touch the monitor screen. The force applied to the monitor screen may cause damage to it.
- Do not apply foreign substances (oils, lubricants, etc.) to the screw parts when assembling the product. (Doing so may damage the product.)
- Applying excessive force when tightening screws may cause damage to the monitor. Damage caused in this way will not be covered by the product warranty.

! NOTE

- You can disassemble the stand in the reverse order of the assembly.

Mounting on a table

- 1 Lift and tilt the Monitor set into its upright position on a table.

Leave a 100 mm (3.94 inches) (minimum) space from the wall for proper ventilation.

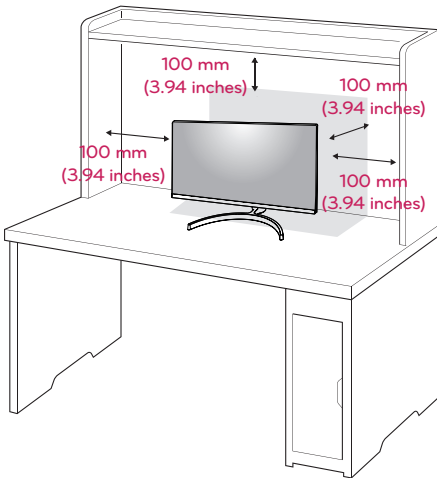

- 3 Press the joystick button on the bottom of the monitor to turn on the monitor.



CAUTION

- Unplug the power cord prior to moving or installing the monitor. There is risk of electric shock.

- 2 Connect the AC-DC Adapter and Power Cord to a wall outlet.

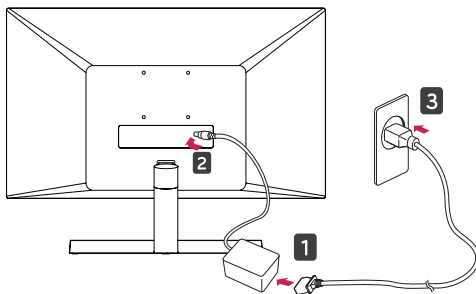

or

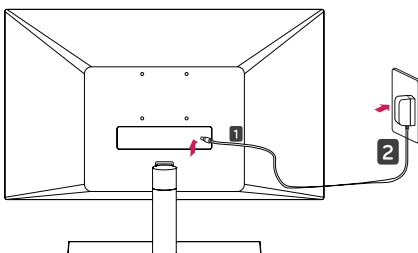

! WARNING

When you adjust the angle, do not hold the bottom of the Monitor set frame as shown on the following illustration, as may injure your fingers.

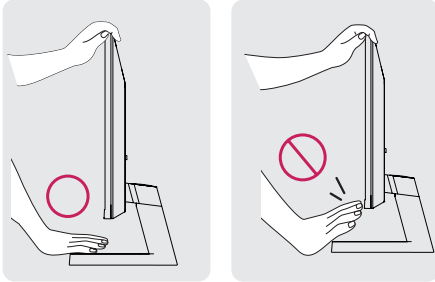

Do not touch or press the screen when adjusting the angle of the monitor.

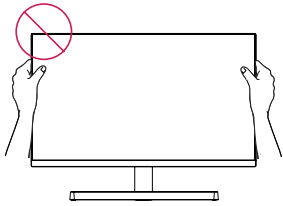

Do not hold this set like below picture. Monitor screen can detach from stand base and injure your body.

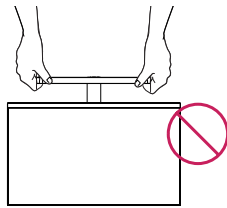

! NOTE

22MK600M **24MK600M**

The angle of the screen can be adjusted forward or backward from -2° to 15° for a comfortable viewing experience.

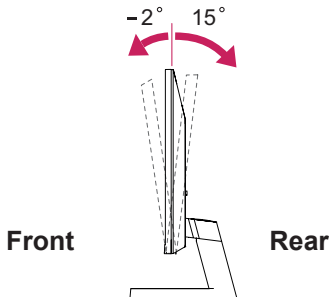

27MK600M **27MK60TM**

The angle of the screen can be adjusted forward or backward from -5° to 15° for a comfortable viewing experience.

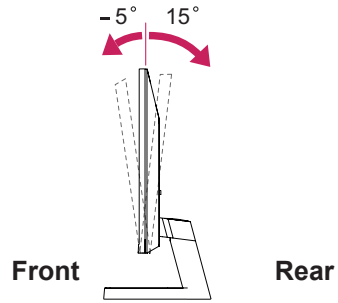

Using the Kensington security system

The Kensington security system connector is located at the back of the Monitor set. For more information of installation and using, refer to the manual supplied with the Kensington security system or visit <http://www.kensington.com>.

Connect the Kensington security system cable between the Monitor set and a table.

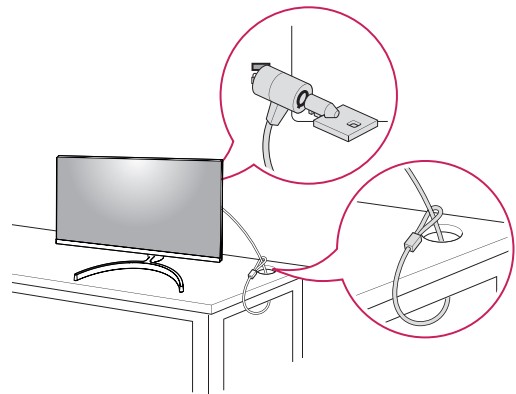

! NOTE

- The Kensington security system is optional. You can obtain it from most electronics stores.

Mounting on a wall

For proper ventilation, allow a clearance of 100 mm (3.94 inches) on each side and from the wall. Detailed instructions are available from your dealer, see the optional Tilt Wall Mounting Bracket Installation and Setup Guide.

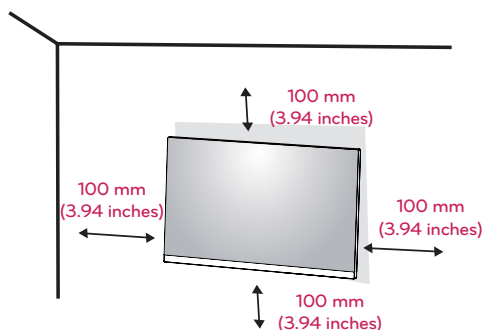

If you intend to mount the Monitor set to a wall, attach Wall mounting interface (optional parts) to the back of the set.

When you install the Monitor set using a wall mounting interface (optional parts), attach it carefully so it will not drop.

- 1 If you use screw longer than standard, the monitor might be damaged internally.
- 2 If you use improper screw, the product might be damaged and drop from mounted position. In this case, LG Electronics is not responsible for it.

Model	22MK600M	24MK600M
Wall Mount (A x B)	75 x 75	
Standard screw	M4	
Number of screws	4	
Wall Mount Plate (Optional)	LSW149	

Model	27MK600M	27MK60TM
Wall Mount (A x B)	100 x 100	
Standard screw	M4	
Number of screws	4	
Wall Mount Plate (Optional)	LSW149	

- Wall Mount (A x B)

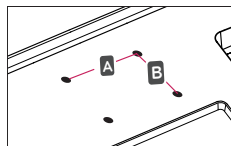

CAUTION

- Disconnect the power cord first, and then move or install the Monitor set. Otherwise electric shock may occur.
- If you install the Monitor set on a ceiling or slanted wall, it may fall and result in severe injury.
- Use only an authorized LG wall mount and contact the local dealer or qualified personnel.
- Do not over tighten the screws as this may cause damage to the Monitor set and void your warranty.
- Use only screws and wall mounts that meet the VESA standard. Any damages or injuries by misuse or using an improper accessory are not covered by the warranty.
- Screw length from outer surface of back cover should be under 8mm.

Wall mount Pad

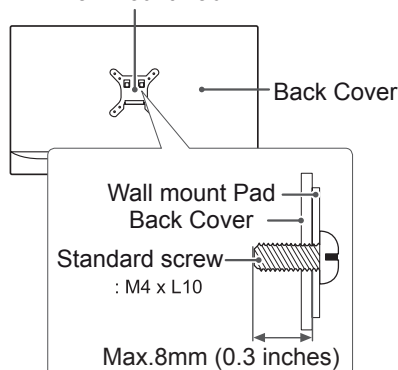

NOTE

- Use the screws that are listed on the VESA standard screw specifications.
- The wall mount kit will include an installation manual and necessary parts.
- The wall mount bracket is optional. You can obtain additional accessories from your local dealer.
- The length of screws may differ depending on the wall mount. Be sure to use the proper length.
- For more information, refer to the instructions supplied with the wall mount.

USING THE MONITOR SET

Connecting to a PC

- Your Monitor set supports Plug & Play*.
- *Plug & Play: A PC recognizes a connected device that users connect to a PC and turn on, without device configuration or user intervention.

D-SUB connection

Transmits analog video from your PC to the Monitor set. Connect the PC and the Monitor set with the supplied D-sub 15 pin signal cable as shown in the following illustrations.

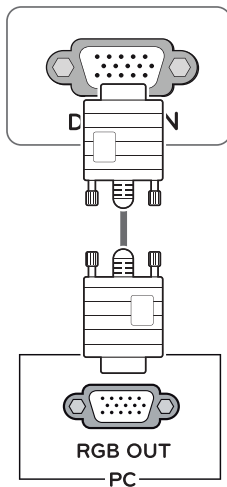

! NOTE

- When using a D-Sub signal input cable connector for Macintosh

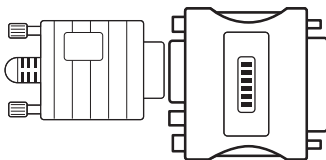

• Mac adapter

For Apple Macintosh use, a separate plug adapter is needed to change the 15 pin high density (3 row) D-SUB VGA connector on the supplied cable to a 15 pin 2 row connector.

HDMI connection

Transmits the digital video and audio signals from your PC to the Monitor set. Connect the PC and the Monitor set with the HDMI cable as shown in the following illustrations.

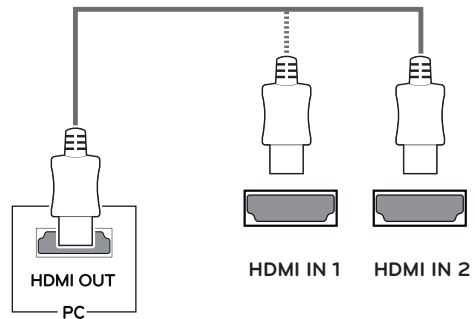

! NOTE

- If you use HDMI PC, it can cause compatibility problem.
- Use a certified cable with the HDMI logo attached. If you do not use a certified HDMI cable, the screen may not display or a connection error may occur.
- Recommended HDMI cable types
 - High-Speed HDMI[®]/TMM Cable
 - High-Speed HDMI[®]/TMM Cable with Ethernet

! NOTE

- When you want to use two PC in our Monitor, please connect the signal cable(D-SUB/ DVI-D/HDMI) respectively in Monitor set.
- If you turn the Monitor set on while it is cold, the screen may flicker. This is normal.
- Some red, green, or blue spots may appear on the screen. This is normal.

Connecting to AV Devices

HDMI connection

Transmits the digital video and audio signals from your AV devices to the monitor. Connect your AV device to the monitor with the HDMI cable as illustrated below.

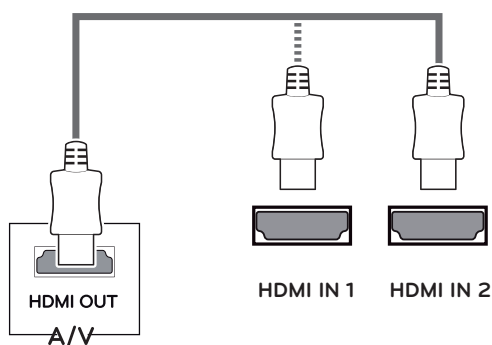

! NOTE

- If you use HDMI PC, it can cause compatibility problem.
- Use a certified cable with the HDMI logo attached. If you do not use a certified HDMI cable, the screen may not display or a connection error may occur.
- Recommended HDMI cable types
 - High-Speed HDMI^{®/TM} Cable
 - High-Speed HDMI^{®/TM} Cable with Ethernet

Connecting Peripherals

Connecting Headphones

Connect peripherals to the monitor via the headphones port. Connect as illustrated.

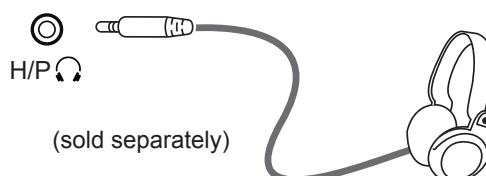

! NOTE

- Peripheral devices are sold separately.
- If you use angled headphones, it may cause a problem with connecting another external device to the monitor. Therefore, it is recommended to use straight headphones.



Angle Type

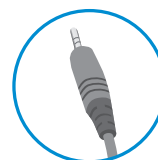

Straight Type

- Depending on the audio settings of the PC and external device, headphones and speaker functions may be limited.

CUSTOMIZING SETTINGS



! NOTE

- Your monitor's OSD (On Screen Display) may differ slightly from that shown in this manual.
- When **Beep Guide** is activated, pressing the joystick button will take you to **Settings** right away.

Activating the Main Menu

- 1 Press the joystick button on the bottom of the monitor.
- 2 Move the joystick up/down (▲/▼) and left/right(◀/▶) to set the options.
- 3 Press the joystick button once more to close the main menu.



Button	Menu Status	Description
	Main menu disabled	Enables the main menu.
	Main menu enabled	Close the main menu. (Long press the button to turn off the monitor)
	◀ Main menu disabled	Adjusts the monitor volume level. (for HDMI only)
	◀ Main menu enabled	Enters the input features.
	▶ Main menu disabled	Adjusts the monitor volume level. (for HDMI only)
	▶ Main menu enabled	Enters the Settings feature.
	▲ Main menu disabled	Enters the Accessibility menu.
	▲ Main menu enabled	Turns off the monitor.
	▼ Main menu disabled	Enters the Accessibility menu.
	▼ Main menu enabled	Enters the picture mode feature. (for HDMI only)

Main Menu Features

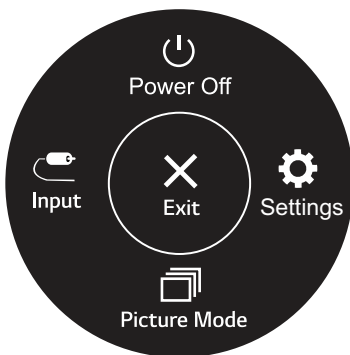

(for HDMI only)

Main Menu	Description
Settings	Configures the screen settings.
Picture Mode	Select picture mode to achieve the best display effect.
Input	Sets input mode.
Power Off	Turns off the monitor.
Exit	Exits the main menu.

Main Menu Features

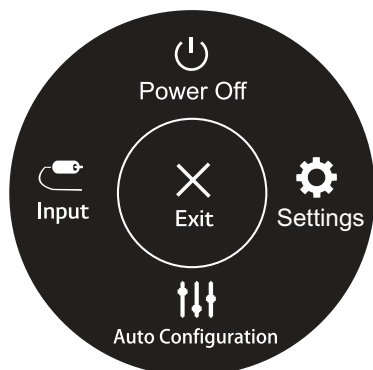

(for D-SUB only)

Main Menu	Description
Settings	Configures the screen settings.
Auto Configuration	Operate the Auto configuration for optimal display in D-SUB.
Input	Sets input mode.
Power Off	Turns off the monitor.
Exit	Exits the main menu.

Customizing settings

Settings > Quick Settings	Description
Brightness	Adjusts the contrast and brightness of the screen.
Contrast	
Volume	Adjusts the volume.(for HDMI only)
<p>! NOTE</p> <ul style="list-style-type: none"> You can adjust Mute/ Unmute by moving the joystick button to ▼ in the Volume menu. 	

Settings > Input	Description	
Input List	Selects the input mode.	
Aspect Ratio	Adjusts the aspect ratio of the screen.	
	Full Wide	Displays the video in wide-screen, regardless of the video signal input.
	Original	Displays video according to the aspect ratio of the video signal input.
<p>! NOTE</p> <ul style="list-style-type: none"> The options may disabled at the recommended resolution (1920 x 1080). 		



Customizing settings

Settings > Picture	Description		
Picture Mode	Custom	Allows the user to adjust each element. The color mode of the main menu can be adjusted.	
	Reader	Optimizes the screen for viewing documents. You can brighten the screen in the OSD menu.	
	Photo	Optimizes the screen to view photos.	
	Cinema	Optimizes the screen to improve the visual effects of a video.	
	Color Weakness	This mode is for users who cannot distinguish between red and green. It enables users with color weakness to easily distinguish between the two colors.	
	Game	Optimizes the screen for gameplay.	
Picture Adjust	Brightness	Adjusts the contrast and brightness of the screen.	
	Contrast		
	Sharpness	Adjusts the sharpness of the screen.	
	SUPER RESOLUTION+	Off	Select this option for everyday viewing. SUPER RESOLUTION+ is turned off in this mode.
		High	Optimized picture quality is displayed when a user wants crystal clear images. It is effective for high quality video or game.
		Middle	The optimized picture quality is displayed when a user wants images between low and high modes for comfortable viewing. It is effective for UCC or SD video.
		Low	The optimized picture quality is displayed when a user wants smooth and natural images. It is effective for slow -moving pictures or still images.
	Black Level		Sets the offset level (for HDMI only). <ul style="list-style-type: none"> Offset: as a reference for a video signal, this is the darkest color the monitor can display.
		High	Keeps the current contrast ratio of the screen.
		Low	Lowers the black levels and raises the white levels from the current contrast ratio of the screen.
	DFC	On	Adjusts the brightness automatically according to the screen.
Off		Disables the DFC feature.	



NOTE

- This is subsidiary for color weakness user. Therefore if you feel uncomfortable with the screen, please turn off this function.
- This function can't distinguish some colors in some images.

Game Adjust	Response Time	Sets a response time for displayed pictures based on the speed of the screen. For a normal environment, it is recommended that you use Fast . For a fast-moving picture, it is recommended that you use Faster . Setting to Faster may cause image sticking.	
		Faster	Sets the response time to faster.
		Fast	Sets the response time to fast.
		Normal	Sets the response time to normal.
		Off	Does not use the response time improvement feature.
	FreeSync	Provides seamless and natural images by synchronizing the vertical frequency of the input signal with that of the output signal.  CAUTION	
		<ul style="list-style-type: none"> Supported Interface: HDMI. Supported Graphic Card: A graphic card that supports AMD's FreeSync is necessary. Supported Version: Make sure to update the graphic card to the latest driver. For more information and requirement, refer to AMD website at http://www.amd.com/FreeSync 	
		On	FreeSync function on.
		Off	FreeSync function off.
	Black Stabilizer	Black Stabilizer: You can control the black contrast to have better visibility in dark scenes. Increasing the Black Stabilizer value brightens the low gray level area on the screen. (You can easily distinguish objects on dark game screens.) Reducing the Black Stabilizer value darkens the low gray level area and increases the dynamic contrast on the screen.	
Cross Hair	Cross Hair provides a mark on the center of the screen for First Person Shooter(FPS) games. Users can select the cross hair that fits their gaming environment among four different cross hairs. <ul style="list-style-type: none"> When the monitor is off or enters energy saving mode, the Cross Hair feature is automatically turned off. 		
Color Adjust	Gamma	Mode 1, Mode 2, Mode 3	The higher the gamma value, the darker the image becomes. Likewise, the lower the gamma value, the lighter the image becomes.
		Mode 4	If you do not need to adjust the gamma settings, select Mode 4.
	Color Temp	Selects the factory default picture color. Custom: The user can adjust it to red, green or blue by customization. Warm: Sets the screen color to a reddish tone. Medium: Sets the screen color between a red and blue tone. Cool: Sets the screen color to a bluish tone.	
	Red/Green/Blue	You can customize the picture color using Red, Green, and Blue colors.	
Configuration Adjust (D-SUB only)	Horizontal	To move image left and right.	
	Vertical	To move image up and down.	
	Clock	To minimize any vertical bars or stripes visible on the screen background. The horizontal screen size will also change.	
	Phase	To adjust the focus of the display. This item allows you to remove any horizontal noise and clear or sharpen the image of characters.	
Resolution (D-SUB only)	User can set the desired resolution. This option is enabled only when the screen resolution on your computer is set to the following (D-SUB only).		
	 NOTE		
	The function is enabled only when the screen resolution on your computer is set to the following, except that the PC output wrong resolution.		
	1024x768, 1280x768, 1360x768, 1366x768, Off		
	1280x960, 1600x900, Off		
1440x900, 1600x900, Off			
Picture Reset	Do you want to reset your settings?		
	No	Cancel the select.	
	Yes	Returns to the default settings.	

Customizing settings

Settings > General	Description	
Language	To choose the language in which the control names are displayed.	
SMART ENERGY SAVING	High	Saves energy using the high-efficiency SMART ENERGY SAVING feature.
	Low	Saves energy using the low-efficiency SMART ENERGY SAVING feature.
	Off	Disables the SMART ENERGY SAVING feature.
Automatic Standby	The monitor will automatically switch to standby mode after a certain period.	
OSD Lock	Prevents incorrect key input.	
	On	Key input is disabled.
	 NOTE <ul style="list-style-type: none"> All function except for the OSD Lock mode, brightness, Contrast, Input, Information and Volume are disabled. 	
	Off	Key input is enabled.
Information	The following display information will be shown the Model, Serial Number, Total Power On Time, Resolution.	
Reset	Do you want to reset your settings?	
	No	Cancel the select.
	Yes	Returns to the default settings.

NOTE

- The value of energy saving data may differ depending on panel and panel suppliers.
- If you select the option of **SMART ENERGY SAVING** is **High** or **Low**, monitor luminance become lower or higher depend on source.

TROUBLESHOOTING

Check the following before calling for service.

No image appears	
Is the power cord of the display connected?	<ul style="list-style-type: none"> Check and see if the power cord is connected properly to the power outlet.
Do you see an "Out of Range" message on the screen?	<ul style="list-style-type: none"> This message appears when the signal from the PC (video card) is out of horizontal or vertical frequency range of the display. See the 'Specifications' section of this manual and configure your display again.
Do you see a "NO SIGNAL" message on the screen or black screen?	<ul style="list-style-type: none"> After the monitor is on "NO SIGNAL", the monitor goes to DPM mode. This is displayed when the signal cable between the PC and the monitor is missing or disconnected. Check the cable and reconnect it. Check PC status.

Can't control some functions in OSD?	
You can't select some menu items in OSD?	<ul style="list-style-type: none"> You can unlock the OSD controls at any time by entering the OSD lock menu and changing items to off.



CAUTION

- Check **Control Panel ► Display ► Settings** and see if the frequency or the resolution were changed. If yes, readjust the video card to the recommend resolution.
- If the recommended resolution (optimal resolution) is not selected, letters may be blurred and the screen may be dimmed, truncated or biased. Make sure to select the recommend resolution.
- The setting method can differ by computer and O/S (Operation System), and resolution mentioned above may not be supported by the video card performance. In this case, please ask to the computer or the video card manufacturer.
- Keep proper posture when using the monitor, otherwise the screen may not be optimized.

Display image is incorrect	
The screen color is mono or abnormal.	<ul style="list-style-type: none"> Check if the signal cable is properly connected and use a screwdriver to fasten if necessary. Make sure the video card is properly inserted in the slot. Set the color setting higher than 24 bits (true color) at Control Panel ► Settings.
The screen blinks.	<ul style="list-style-type: none"> Check if the screen is set to interlace mode and if yes, change it to the recommend resolution.

Do you see an "Unrecognized monitor, Plug&Play (VESA DDC) monitor found" message?	
Have you installed the display driver?	<ul style="list-style-type: none"> Be sure to install the display driver from our web site: http://www.lg.com. Make sure to check if the video card supports Plug&Play function.

The screen is flickering.	
Did you select the recommended resolution?	<ul style="list-style-type: none"> If the selected resolution is HDMI 1080i 60/50 Hz, the screen may be flickering. Change the resolution to the recommended resolution 1080P.

SPECIFICATIONS

22MK600M

LCD Screen	Type	TFT (Thin Film Transistor) LCD(Liquid Crystal Display) Screen
	Pixel Pitch	0.24795 mm x 0.24795 mm
Resolution	Maximum Resolution	1920 x 1080 @ 75 Hz (HDMI) 1920 x 1080 @ 60 Hz (D-sub)
	Recommended Resolution	1920 x 1080 @ 60 Hz
	Video Signal	Horizontal Frequency
Video Signal	Vertical Frequency	HDMI -PC: 56 Hz to 75 Hz -AV: 50 Hz to 61 Hz D-SUB: 56 Hz to 75 Hz
	Synchronization	Separate Sync, Digital.
	Input Connector	HDMI IN 1, HDMI IN 2, D-SUB IN, H/P OUT
Power Input	19 V ---1.3 A	
Power Consumption	On Mode: 16.4 W Typ. (Outgoing condition) * Sleep Mode (Standby Mode) ≤ 0.3 W ** Off Mode ≤ 0.3 W	
AC/DC adaptor	Type ADS-40SG-19-3 19025G, manufactured by SHENZHEN HONOR ELECTRONIC or Type ADS-40FSG-19 19025GPG-1, manufactured by SHENZHEN HONOR ELECTRONIC or Type ADS-40FSG-19 19025GPBR-1, manufactured by SHENZHEN HONOR ELECTRONIC or Type ADS-40FSG-19 19025GPI-1, manufactured by SHENZHEN HONOR ELECTRONIC or Type ADS-40FSG-19 19025GPCU-1, manufactured by SHENZHEN HONOR ELECTRONIC or Type ADS-40FSG-19 19025GPB-2, manufactured by SHENZHEN HONOR ELECTRONIC or Type ADS-25SFA-19-3 19025E, manufactured by SHENZHEN HONOR ELECTRONIC or Type ADS-25FSF-19 19025EPCU-1, manufactured by SHENZHEN HONOR ELECTRONIC or Type ADS-25FSF-19 19025EPBR-1, manufactured by SHENZHEN HONOR ELECTRONIC or Type ADS-25FSF-19 19025EPI-1, manufactured by SHENZHEN HONOR ELECTRONIC or Type ADS-25FSF-19 19025EPG-1, manufactured by SHENZHEN HONOR ELECTRONIC or Type ADS-25FSF-19 19025EPB-1, manufactured by SHENZHEN HONOR ELECTRONIC or Type LCAP21, manufactured by LIEN CHANG ELECTRONIC ENTERPRISE or Type LCAP26-A, manufactured by LIEN CHANG ELECTRONIC ENTERPRISE or Type LCAP26-E, manufactured by LIEN CHANG ELECTRONIC ENTERPRISE or Type LCAP26-I, manufactured by LIEN CHANG ELECTRONIC ENTERPRISE or Type LCAP26-B, manufactured by LIEN CHANG ELECTRONIC ENTERPRISE or Type WA-24C19FS, manufactured by Asian Power Devices Inc. or Type WA-24C19FN, manufactured by Asian Power Devices Inc. or Type DA-24B19, manufactured by Asian Power Devices Inc. or Type AD10560LF, manufactured by PI Electronics (H.K.) Ltd. or Type AD2139S20, manufactured by PI Electronics (H.K.) Ltd. or Type AD2139G20, manufactured by PI Electronics (H.K.) Ltd. OUTPUT: 19 V --- 1.3 A	
Environmental conditions	Operating Temperature Operating Humidity	0 °C to 40 °C (32 °F to 104 °F) Less than 80%
	Storage Temperature Storage Humidity	-20 °C to 60 °C (-4 °F to 140 °F) Less than 85 %

Dimension	Monitor Size (Width x Height x Depth)	
	With Stand	488.7 x 386.7 x 182.0 (mm) 19.2 x 15.2 x 7.1 (inches)
	Without Stand	488.7 x 293.0 x 66.8 (mm) 19.2 x 11.5 x 2.6 (inches)
Weight (Without Packaging)	With Stand	2.7 kg (5.9 lbs)
	Without Stand	2.3 kg (5.0 lbs)

The specifications are subject to change without notice.

The power consumption level can be different by operating condition and monitor setting.

* The On mode power consumption is measured with LGE test standard (Full White pattern , Maximum resolution).

** The monitor goes to the Sleep Mode in a couple of minutes(Max 5 minutes).

SPECIFICATIONS

24MK600M

LCD Screen	Type	TFT (Thin Film Transistor) LCD(Liquid Crystal Display) Screen
	Pixel Pitch	0.2745 mm x 0.2745 mm
Resolution	Maximum Resolution	1920 x 1080 @ 75 Hz (HDMI) 1920 x 1080 @ 60 Hz (D-sub)
	Recommended Resolution	1920 x 1080 @ 60 Hz
Video Signal	Horizontal Frequency	HDMI: 30 kHz to 85 kHz D-SUB: 30 kHz to 83 kHz
	Vertical Frequency	HDMI -PC: 56 Hz to 75 Hz -AV: 50 Hz to 61 Hz D-SUB: 56 Hz to 75 Hz
	Synchronization	Separate Sync, Digital.
Input Connector	HDMI IN 1,HDMI IN 2, D-SUB IN, H/P OUT	
Power Input	19 V ---1.3 A	
Power Consumption	On Mode: 17.5 W Typ. (Outgoing condition) * Sleep Mode (Standby Mode) ≤ 0.3 W ** Off Mode ≤ 0.3 W	
AC/DC adaptor	<p>Type ADS-40SG-19-3 19025G, manufactured by SHENZHEN HONOR ELECTRONIC or Type ADS-40FSG-19 19025GPG-1, manufactured by SHENZHEN HONOR ELECTRONIC or Type ADS-40FSG-19 19025GPBR-1, manufactured by SHENZHEN HONOR ELECTRONIC or Type ADS-40FSG-19 19025GPI-1, manufactured by SHENZHEN HONOR ELECTRONIC or Type ADS-40FSG-19 19025GPCU-1, manufactured by SHENZHEN HONOR ELECTRONIC or Type ADS-40FSG-19 19025GPB-2, manufactured by SHENZHEN HONOR ELECTRONIC or Type ADS-25SFA-19-3 19025E, manufactured by SHENZHEN HONOR ELECTRONIC or Type ADS-25FSF-19 19025EPCU-1, manufactured by SHENZHEN HONOR ELECTRONIC or Type ADS-25FSF-19 19025EPBR-1, manufactured by SHENZHEN HONOR ELECTRONIC or Type ADS-25FSF-19 19025EPI-1, manufactured by SHENZHEN HONOR ELECTRONIC or Type ADS-25FSF-19 19025EPG-1, manufactured by SHENZHEN HONOR ELECTRONIC or Type ADS-25FSF-19 19025EPB-1, manufactured by SHENZHEN HONOR ELECTRONIC or Type LCAP21, manufactured by LIEN CHANG ELECTRONIC ENTERPRISE or Type LCAP26-A, manufactured by LIEN CHANG ELECTRONIC ENTERPRISE or Type LCAP26-E, manufactured by LIEN CHANG ELECTRONIC ENTERPRISE or Type LCAP26-I, manufactured by LIEN CHANG ELECTRONIC ENTERPRISE or Type LCAP26-B, manufactured by LIEN CHANG ELECTRONIC ENTERPRISE or Type WA-24C19FS, manufactured by Asian Power Devices Inc. or Type WA-24C19FN, manufactured by Asian Power Devices Inc. or Type DA-24B19, manufactured by Asian Power Devices Inc. or Type AD10560LF, manufactured by PI Electronics (H.K.) Ltd. or Type AD2139S20, manufactured by PI Electronics (H.K.) Ltd. or Type AD2139G20, manufactured by PI Electronics (H.K.) Ltd.</p>	
	OUTPUT: 19 V --- 1.3 A	

Environmental conditions	Operating Temperature Operating Humidity	0 °C to 40 °C (32 °F to 104 °F) Less than 80%
	Storage Temperature Storage Humidity	-20 °C to 60 °C (-4 °F to 140 °F) Less than 85 %
Dimension	Monitor Size (Width x Height x Depth)	
	With Stand	539.1 x 415.3 x 182.0 (mm) 21.2 x 16.3 x 7.1 (inches)
	Without Stand	539.1 x 321.5 x 66.5 (mm) 21.2 x 12.6 x 2.6 (inches)
Weight (Without Packaging)	With Stand	3.5 kg (7.7 lbs)
	Without Stand	3.1 kg (6.8 lbs)

The specifications are subject to change without notice.

The power consumption level can be different by operating condition and monitor setting.

* The On mode power consumption is measured with LGE test standard (Full White pattern , Maximum resolution).

** The monitor goes to the Sleep Mode in a couple of minutes(Max 5 minutes).

SPECIFICATIONS

27MK600M

27MK60TM

LCD Screen	Type	TFT (Thin Film Transistor) LCD(Liquid Crystal Display) Screen
	Pixel Pitch	0.3114 mm x 0.3114 mm
Resolution	Maximum Resolution	1920 x 1080 @ 75 Hz (HDMI) 1920 x 1080 @ 60 Hz (D-sub)
	Recommended Resolution	1920 x 1080 @ 60 Hz
Video Signal	Horizontal Frequency	HDMI: 30 kHz to 85 kHz D-SUB: 30 kHz to 83 kHz
	Vertical Frequency	HDMI -PC: 56 Hz to 75 Hz -AV: 50 Hz to 61 Hz D-SUB: 56 Hz to 75 Hz
	Synchronization	Separate Sync, Digital.
Input Connector	HDMI IN 1,HDMI IN 2, D-SUB IN, H/P OUT	
Power Input	19 V ---1.3 A	
Power Consumption	On Mode: 25.5 W Typ. (Outgoing condition)* Sleep Mode (Standby Mode) ≤ 0.3 W ** Off Mode ≤ 0.3 W	
AC/DC adaptor	<p>Type ADS-40SG-19-3 19025G, manufactured by SHENZHEN HONOR ELECTRONIC or Type ADS-40FSG-19 19025GPG-1, manufactured by SHENZHEN HONOR ELECTRONIC or Type ADS-40FSG-19 19025GPBR-1, manufactured by SHENZHEN HONOR ELECTRONIC or Type ADS-40FSG-19 19025GPI-1, manufactured by SHENZHEN HONOR ELECTRONIC or Type ADS-40FSG-19 19025GPCU-1, manufactured by SHENZHEN HONOR ELECTRONIC or Type ADS-40FSG-19 19025GPB-2, manufactured by SHENZHEN HONOR ELECTRONIC or Type ADS-25SFA-19-3 19025E, manufactured by SHENZHEN HONOR ELECTRONIC or Type ADS-25FSF-19 19025EPCU-1, manufactured by SHENZHEN HONOR ELECTRONIC or Type ADS-25FSF-19 19025EPBR-1, manufactured by SHENZHEN HONOR ELECTRONIC or Type ADS-25FSF-19 19025EPI-1, manufactured by SHENZHEN HONOR ELECTRONIC or Type ADS-25FSF-19 19025EPG-1, manufactured by SHENZHEN HONOR ELECTRONIC or Type ADS-25FSF-19 19025EPB-1, manufactured by SHENZHEN HONOR ELECTRONIC or Type LCAP21, manufactured by LIEN CHANG ELECTRONIC ENTERPRISE or Type LCAP26-A, manufactured by LIEN CHANG ELECTRONIC ENTERPRISE or Type LCAP26-E, manufactured by LIEN CHANG ELECTRONIC ENTERPRISE or Type LCAP26-I, manufactured by LIEN CHANG ELECTRONIC ENTERPRISE or Type LCAP26-B, manufactured by LIEN CHANG ELECTRONIC ENTERPRISE or Type WA-24C19FS, manufactured by Asian Power Devices Inc. or Type WA-24C19FN, manufactured by Asian Power Devices Inc. or Type DA-24B19, manufactured by Asian Power Devices Inc. or Type AD10560LF, manufactured by PI Electronics (H.K.) Ltd. or Type AD2139S20, manufactured by PI Electronics (H.K.) Ltd. or Type AD2139G20, manufactured by PI Electronics (H.K.) Ltd.</p>	
	OUTPUT: 19 V --- 1.3 A	
Environmental conditions	Operating Temperature	0 °C to 40 °C (32 °F to 104 °F)
	Operating Humidity	Less than 80%
	Storage Temperature	-20 °C to 60 °C (-4 °F to 140 °F)
	Storage Humidity	Less than 85 %

Dimension	Monitor Size (Width x Height x Depth)	
	With Stand	611.2 x 453.9 x 209.4 (mm) 24.0 x 17.8 x 8.2 (inches)
	Without Stand	611.2 x 362.6 x 72.7 (mm) 24.0 x 14.2 x 2.8 (inches)
Weight (Without Packaging)	With Stand	4.8 kg (10.5 lbs)
	Without Stand	4.3 kg (9.4 lbs)

The specifications are subject to change without notice.

The power consumption level can be different by operating condition and monitor setting.

* The On mode power consumption is measured with LGE test standard (Full White pattern , Maximum resolution).

** The monitor goes to the Sleep Mode in a couple of minutes(Max 5 minutes).

Preset Modes (Resolution)

D-SUB PC Timing

Display Modes (Resolution)	Horizontal Frequency(kHz)	Vertical Frequency(Hz)	Polarity(H/V)	
720 x 400	31.468	70.08	-/+	
640 x 480	31.469	59.94	-/-	
640 x 480	37.5	75	-/-	
800 x 600	37.879	60.317	+/+	
800 x 600	46.875	75	+/+	
1024 x 768	48.363	60	-/-	
1024 x 768	60.023	75.029	+/+	
1152 x 864	67.500	75	+/+	
1280 x 1024	63.981	60.023	+/+	
1280 x 1024	79.976	75.035	+/+	
1680 x 1050	65.290	59.954	-/+	
1920 x 1080	67.500	60	+/+	Recommend Mode

HDMI PC Timing

Display Modes (Resolution)	Horizontal Frequency(kHz)	Vertical Frequency(Hz)	Polarity(H/V)	
720 x 400	31.468	70.08	-/+	
640 x 480	31.469	59.94	-/-	
640 x 480	37.5	75	-/-	
800 x 600	37.879	60.317	+/+	
800 x 600	46.875	75	+/+	
1024 x 768	48.363	60	-/-	
1024 x 768	60.023	75.029	+/+	
1152 x 864	67.500	75	+/+	
1280 x 1024	63.981	60.023	+/+	
1280 x 1024	79.976	75.035	+/+	
1680 x 1050	65.290	59.954	-/+	
1920 x 1080	67.500	60	+/+	Recommend Mode
1920 x 1080	83.89	74.97	+/+	

HDMI AV Timing

Factory support mode (Preset Mode)	Horizontal Frequency(kHz)	Vertical Frequency(Hz)	HDMI
480P	31.50	60	<input type="radio"/>
576P	31.25	50	<input type="radio"/>
720P	37.50	50	<input type="radio"/>
720P	45.00	60	<input type="radio"/>
1080P	56.25	50	<input type="radio"/>
1080P	67.50	60	<input type="radio"/> Recommend Mode

Beep Guide

Menu	Location
Quick Settings	1
Quick Settings - Brightness	1 1
Quick Settings - Brightness	1 1 1 Slider
Quick Settings - Contrast	1 2
Quick Settings - Contrast	1 2 1 Slider
Quick Settings - Volume	1 3
Quick Settings - Volume	1 3 1 Slider
Quick Settings - Auto Configuration(only Dsub)	1 4
Quick Settings - Auto Configuration(only Dsub) - No	1 4 1
Quick Settings - Auto Configuration(only Dsub) - Yes	1 4 2
Input	2
Input - Input List	2 1
Input - Input List - DSUB	2 1 1
Input - Input List - HDMI1	2 1 2
Input - Input List - HDMI2	2 1 3
Input - Aspect Ratio	2 2
Input - Aspect Ratio - Full Wide	2 2 1
Input - Aspect Ratio - Original	2 2 2
Picture	3
Picture - Picture Mode	3 1
Picture - Picture Mode - Custom	3 1 1
Picture - Picture Mode - Reader	3 1 2
Picture - Picture Mode - Photo	3 1 3
Picture - Picture Mode - Cinema	3 1 4
Picture - Picture Mode - Color Weakness	3 1 5
Picture - Picture Mode - Game	3 1 6
Picture - Picture Adjust	3 2
Picture - Picture Adjust - Brightness	3 2 1
Picture - Picture Adjust - Brightness	3 2 1 1 Slider
Picture - Picture Adjust - Contrast	3 2 2
Picture - Picture Adjust - Contrast	3 2 2 1 Slider
Picture - Picture Adjust - Sharpness	3 2 3
Picture - Picture Adjust - Sharpness	3 2 3 1 Slider
Picture - Picture Adjust - SUPER RESOLUTION+	3 2 4
Picture - Picture Adjust - SUPER RESOLUTION+ - Off	3 2 4 1
Picture - Picture Adjust - SUPER RESOLUTION+ - High	3 2 4 2

Menu	Location
Picture - Picture Adjust - SUPER RESOLUTION+ - Middle	3 2 4 3
Picture - Picture Adjust - SUPER RESOLUTION+ - Low	3 2 4 4
Picture - Picture Adjust - Black Level	3 2 5
Picture - Picture Adjust - Black Level - High	3 2 5 1
Picture - Picture Adjust - Black Level - Low	3 2 5 2
Picture - Picture Adjust - DFC	3 2 6
Picture - Picture Adjust - DFC - On	3 2 6 1
Picture - Picture Adjust - DFC - Off	3 2 6 2
Picture - Game Adjust	3 3
Picture - Game Adjust - Response Time	3 3 1
Picture - Game Adjust - Response Time - Faster	3 3 1 1
Picture - Game Adjust - Response Time - Fast	3 3 1 2
Picture - Game Adjust - Response Time - Normal	3 3 1 3
Picture - Game Adjust - Response Time - Off	3 3 1 4
Picture - Game Adjust - FreeSync	3 3 2
Picture - Game Adjust - FreeSync - On	3 3 2 1
Picture - Game Adjust - FreeSync - Off	3 3 2 2
Picture - Game Adjust - Black Stabilizer	3 3 3
Picture - Game Adjust - Black Stabilizer	3 3 3 1 Slider
Picture - Game Adjust - Cross Hair	3 3 4
Picture - Game Adjust - Cross Hair - Red Cross	3 3 4 1
Picture - Game Adjust - Cross Hair - Green Cross	3 3 4 2
Picture - Game Adjust - Cross Hair - Red Dot	3 3 4 3
Picture - Game Adjust - Cross Hair - Green Dot	3 3 4 4
Picture - Game Adjust - Cross Hair - Off	3 3 4 5
Picture - Color Adjust	3 4
Picture - Color Adjust - Gamma	3 4 1
Picture - Color Adjust - Gamma - Mode 1	3 4 1 1
Picture - Color Adjust - Gamma - Mode 2	3 4 1 2
Picture - Color Adjust - Gamma - Mode 3	3 4 1 3
Picture - Color Adjust - Gamma - Mode 4	3 4 1 4
Picture - Color Adjust - Color Temp	3 4 2

Menu	Location
Picture - Color Adjust - Color Temp - Custom	3 4 2 1
Picture - Color Adjust - Color Temp - Warm	3 4 2 2
Picture - Color Adjust - Color Temp - Medium	3 4 2 3
Picture - Color Adjust - Color Temp - Cool	3 4 2 4
Picture - Color Adjust - Red	3 4 3
Picture - Color Adjust - Red	3 4 3 1 Slider
Picture - Color Adjust - Green	3 4 4
Picture - Color Adjust - Green	3 4 4 1 Slider
Picture - Color Adjust - Blue	3 4 5
Picture - Color Adjust - Blue	3 4 5 1 Slider
Picture - Configuration Adjust (Only D-sub)	3 5
Picture - Configuration Adjust (Only D-sub) - Horizontal	3 5 1
Picture - Configuration Adjust (Only D-sub) - Horizontal	3 5 1 1 Slider
Picture - Configuration Adjust (Only D-sub) - Vertical	3 5 2
Picture - Configuration Adjust (Only D-sub) - Vertical	3 5 2 1 Slider
Picture - Configuration Adjust (Only D-sub) - Clock	3 5 3
Picture - Configuration Adjust (Only D-sub) - Clock	3 5 3 1 Slider
Picture - Configuration Adjust (Only D-sub) - Phase	3 5 4
Picture - Configuration Adjust (Only D-sub) - Phase	3 5 4 1 Slider
Picture - Resolution(Only D-sub)	3 6
Picture - Resolution(Only D-sub) - 1024*768	3 6 1
Picture - Resolution(Only D-sub) - 1280*768	3 6 2
Picture - Resolution(Only D-sub) - 1360*768	3 6 3
Picture - Resolution(Only D-sub) - 1366*768	3 6 4
Picture - Resolution(Only D-sub) - Off	3 6 5
Picture - Resolution(Only D-sub) - 1280*960	3 6 1
Picture - Resolution(Only D-sub) - 1600*900	3 6 2
Picture - Resolution(Only D-sub) - Off	3 6 3
Picture - Resolution(Only D-sub) - 1440*900	3 6 1
Picture - Resolution(Only D-sub) - 1600*900	3 6 2
Picture - Resolution(Only D-sub) - Off	3 6 3

Menu	Location
Picture - Picture Reset	3 7
Picture - Picture Reset - No	3 7 1
Picture - Picture Reset - Yes	3 7 2
General	4
General - Language	4 1
General - Language - English	4 1 1
General - Language - German	4 1 2
General - Language - French	4 1 3
General - Language - Spanish	4 1 4
General - Language - Italian	4 1 5
General - Language - Swedish	4 1 6
General - Language - Finnish	4 1 7
General - Language - Portuguese	4 1 8
General - Language - Portuguese (Brazil)	4 1 9
General - Language - Polish	4 1 10
General - Language - Russian	4 1 11
General - Language - Greek	4 1 12
General - Language - Ukrainian	4 1 13
General - Language - Chinese	4 1 14
General - Language - Traditional Chinese	4 1 15
General - Language - Japanese	4 1 16
General - Language - Korean	4 1 17
General - Language - Hindi	4 1 18
General - SMART ENERGY SAVING	4 2
General - SMART ENERGY SAVING - High	4 2 1
General - SMART ENERGY SAVING - Low	4 2 2
General - SMART ENERGY SAVING - Off	4 2 3
General - Automatic Standby	4 3
General - Automatic Standby - 4H	4 3 1
General - Automatic Standby - 6H	4 3 2
General - Automatic Standby - 8H	4 3 3
General - Automatic Standby - Off	4 3 4
General - OSD Lock	4 4
General - OSD Lock - On	4 4 1
General - OSD Lock - Off	4 4 2
General - Information	4 5
General - Information	4 5 1
General - Reset	4 6

Menu	Location
General - Reset - No	4 6 1
General - Reset - Yes	4 6 2



Supplier's Declaration of Conformity

Trade Name	LG
Responsible Party	LG Electronics USA, Inc.
Address	111 Sylvan Avenue, North Building, Englewood Cliffs, NJ 07632
E-mail	lg.environmental@lge.com

The model and serial number of the product are located on the back and on one side of the product. Record them below in case you ever need service.

MODEL _____

SERIAL _____