

PHILIPS

Momentum

278M1



www.philips.com/welcome

EN	User manual	1
	Customer care and warranty	22
	Troubleshooting & FAQs	26

Table of Contents

1. Important	1
1.1 Safety precautions and maintenance	1
1.2 Notational Descriptions	3
1.3 Disposal of product and packing material.....	4
2. Setting up the monitor.....	5
2.1 Installation	5
2.2 Operating the monitor.....	7
2.3 Remove the Base Assembly for VESA Mounting.....	10
3. Image Optimization	11
3.1 SmartImage	11
3.2 SmartContrast.....	13
4. Ambiglow	14
5. HDR	15
6. AMD FreeSync™	16
7. Technical Specifications	17
7.1 Resolution & Preset Modes	20
8. Power Management	21
9. Customer care and warranty ..	22
9.1 Philips' Flat Panel Monitors Pixel Defect Policy.....	22
9.2 Customer Care & Warranty.....	25
10. Troubleshooting & FAQs.....	26
10.1 Troubleshooting.....	26
10.2 General FAQs.....	27

1. Important

This electronic user's guide is intended for anyone who uses the Philips monitor. Take time to read this user's manual before you use your monitor. It contains important information and notes regarding the operation of your monitor.

The Philips guarantee applies provided the product is handled properly for its intended use, in accordance with its operating instructions and upon presentation of the original invoice or cash receipt, indicating the date of purchase, dealer's name and model and production number of the product.

1.1 Safety precautions and maintenance

Warnings

Use of controls, adjustments or procedures other than those specified in this documentation may result in exposure to shock, electrical hazards and/or mechanical hazards.

Read and follow these instructions when connecting and using your computer monitor.

Excessive sound pressure from earphones and headphones can cause hearing loss. Adjustment of the equalizer to maximum increases the earphones and headphones output voltage and therefore the sound pressure level.

Operation

- Please Keep the monitor out of direct sunlight, very strong bright lights and away from any other heat source. Lengthy exposure to this type of environment may result in discoloration and damage to the monitor.
- Keep the display away from oil. Oil may damage the plastic cover of the display and void the warranty.
- Remove any object that could fall into ventilation holes or prevent proper cooling of the monitor's electronics.
- Do not block the ventilation holes on the cabinet.
- When positioning the monitor, make sure the power plug and outlet are easily accessible.
- If turning off the monitor by detaching the power cable or DC power cord, wait for 6 seconds before attaching the power cable or DC power cord for normal operation.
- Please use approved power cord provided by Philips all the time. If your power cord is missing, please contact with your local service center. (Please refer to Service Regulation & Service Information Manual.)
- Operate under the specified power supply. Be sure to operate the monitor only with the specified power supply. Use of an incorrect voltage will cause malfunction and may cause fire or electric shock.
- Do not disassemble the AC adapter. Disassembling the AC adapter may expose you to the danger of fire or electric shock.
- Protect the cable. Do not pull or bend the power cable and signal cable. Do not place the monitor or any other heavy objects on the cables, if damaged, the cables may cause fire or electric shock.
- Do not subject the monitor to severe vibration or high impact conditions during operation.

i. Important

- To avoid potential damage, for example the panel peeling from the bezel, ensure that the monitor does not tilt downward by more than -5 degrees. If the -5 degree downward tilt angle maximum is exceeded, the monitor damage will not be covered under warranty.
- Do not knock or drop the monitor during operation or transportation.
- Excessive usage of monitor can cause eye discomfort, it's better to take shorter breaks more often at your workstation than longer breaks and less often; for example a 5-10 minute break after 50-60-minute continuous screen use is likely to be better than a 15-minute break every two hours. Try to keep your eyes from eye strain while using the screen for a constant period of time by :
 - Looking at something varying distances after a long period focusing on the screen.
 - Conscious Blinking often while you work.
 - Gently closing and rolling your eyes to relax.
 - Reposition your screen to appropriate height and angle according to your height.
 - Adjusting the brightness and contrast to appropriate level.
 - Adjusting the environment lighting similar to that of your screen brightness, avoid the fluorescent lighting, and surfaces that don't reflect too much light.
 - Seeing a doctor if your symptoms.
- panel. When moving your monitor, grasp the frame to lift; do not lift the monitor by placing your hand or fingers on the LCD panel.
- Oil-based cleaning solutions may damage the plastic parts and void the warranty.
- Unplug the monitor if you are not going to use it for an extensive period of time.
- Unplug the monitor if you need to clean it with a slightly damp cloth. The screen may be wiped with a dry cloth when the power is off. However, never use organic solvent, such as, alcohol, or ammonia-based liquids to clean your monitor.
- To avoid the risk of shock or permanent damage to the set, do not expose the monitor to dust, rain, water, or excessive moisture environment.
- If your monitor gets wet, wipe it with dry cloth as soon as possible.
- If foreign substance or water gets in your monitor, please turn the power off immediately and disconnect the power cord. Then, remove the foreign substance or water, and send it to the maintenance center.
- Do not store or use the monitor in locations exposed to heat, direct sunlight or extreme cold.
- In order to maintain the best performance of your monitor and use it for a longer lifetime, please use the monitor in a location that falls within the following temperature and humidity ranges.
 - Temperature: 0-40°C 32-104°F
 - Humidity: 20-80% RH

Maintenance

- To protect your monitor from possible damage, do not put excessive pressure on the LCD

Important information for Burn-in/ Ghost image

i. Important

- Always activate a moving screen saver program when you leave your monitor unattended. Always activate a periodic screen refresh application if your monitor will display unchanging static content. Uninterrupted display of still or static images over an extended period may cause “Burn-in”, also known as “after-imaging” or “ghost imaging”, on your screen.
- “Burn-in”, “after-imaging”, or “ghost imaging” is a well-known phenomenon in LCD panel technology. In most cases, the “burned in” or “after-imaging” or “ghost imaging” will disappear gradually over a period of time after the power has been switched off.

Warning

Failure to activate a screen saver, or a periodic screen refresh application may result in severe “burn-in” or “after-image” or “ghost image” symptoms that will not disappear and cannot be repaired. The damage mentioned above is not covered under your warranty.

Service

- The casing cover should be opened only by qualified service personnel.
- If there is any need for any document for repair or integration, please contact with your local service center. (Please refer to Service contact information listed in Regulation & Service Information Manual.)
- For transportation information, please refer to “Technical Specifications”.
- Do not leave your monitor in a car/trunk under direct sun light.

Note

Consult a service technician if the monitor does not operate normally, or you are not sure what procedure to take when the operating instructions given in this manual have been followed.

1.2 Notational Descriptions

The following subsections describe notational conventions used in this document.

Notes, Cautions and Warnings

Throughout this guide, blocks of text may be accompanied by an icon and printed in bold or italic type. These blocks contain notes, cautions or warnings. They are used as follows:

Note

This icon indicates important information and tips that help you make better use of your computer system.

Caution

This icon indicates information that tells you how to avoid either potential damage to hardware or loss of data.

Warning

This icon indicates the potential for bodily harm and tells you how to avoid the problem.

Some warnings may appear in alternate formats and may not be accompanied by an icon. In such cases, the specific presentation of the warning is mandated by the relevant regulatory authority.

1.3 Disposal of product and packing material

Waste Electrical and Electronic Equipment-WEEE



This marking on the product or on its packaging illustrates that, under European Directive 2012/19/EU governing used electrical and electronic appliances, this product may not be disposed of with normal household waste. You are responsible for disposal of this equipment through a designated waste electrical and electronic equipment collection. To determine the locations for dropping off such waste electrical and electronic, contact your local government office, the waste disposal organization that serves your household or the store at which you purchased the product.

Your new monitor contains materials that can be recycled and reused. Specialized companies can recycle your product to increase the amount of reusable materials and to minimize the amount to be disposed of.

All redundant packing material has been omitted. We have done our utmost to make the packaging easily separable into mono materials.

Please find out about the local regulations on how to dispose of your old monitor and packing from your sales representative.

Taking back/Recycling Information for Customers

Philips establishes technically and economically viable objectives to optimize the environmental performance of the organization's product, service and activities.

From the planning, design and production stages, Philips emphasizes the important of making products that can easily be recycled. At Philips, end-of-life management primarily entails participation in national take-back initiatives and recycling programs whenever possible, preferably in cooperation with competitors, which recycle all materials (products and related packaging material) in accordance with all Environmental Laws and taking back program with the contractor company.

Your display is manufactured with high quality materials and components which can be recycled and reused.

To learn more about our recycling program please visit:

<http://www.philips.com/a-w/about/sustainability.html>

2. Setting up the monitor

2.1 Installation

1 Package contents

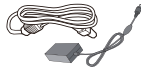
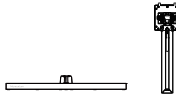

AC/DC Adapter



* DP



* HDMI



* USB A-B

* Different according to region

Note

278M1R: Use only AC/DC adapter model: Philips ADPC20120.

2 Install base stand

1. In order to well protect this monitor and avoid scratching or damaging of the monitor, keep the monitor face down in the cushion for the base installation.

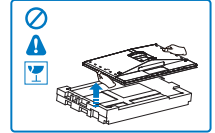
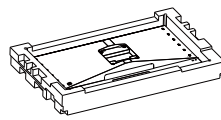

2. Hold the stand with both hands.
 - (1) Gently attach the base to the stand.
 - (2) Use your fingers to tighten the screw located at the bottom of the base.
 - (3) Use a screwdriver to tighten the screw located at the bottom of the base, and secure the base to the stand tightly.
 - (4) Gently attach the stand to the VESA mount area until the latch locks the stand.

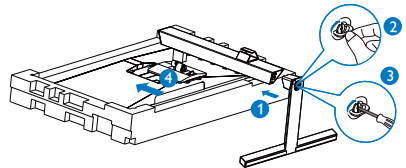

3. After attaching the base, erect the monitor with both hands on holding the monitor together with styrofoam firmly. Now you can pull out the styrofoam. When you pull out the styrofoam, do not squeeze the panel to avoid broken panel.

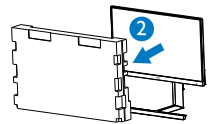
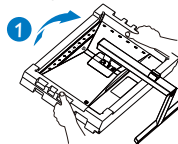

2. Setting up the monitor

3 Connecting to your computer

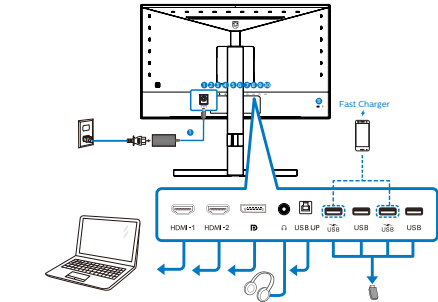

USB hub

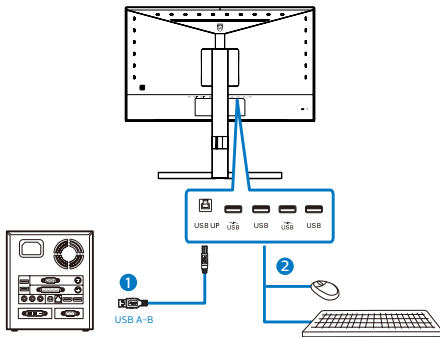

- ❶ AC/DC power input
- ❷ HDMI-1 input
- ❸ HDMI-2 input
- ❹ DisplayPort input
- ❺ Earphone output
- ❻ USB upstream
- ❼ USB downstream/USB fast charger
- ❽ USB downstream
- ❾ USB downstream/USB fast charger
- ❿ USB downstream
- ⓫ Kensington anti-theft lock

Connect to PC

1. Connect the power cord to the back of the monitor firmly.
2. Turn off your computer and unplug its power cable.
3. Connect the monitor signal cable to the video connector on the back of your computer.
4. Plug the power cord of your computer and your monitor into a nearby outlet.
5. Turn on your computer and monitor. If the monitor displays an image, installation is complete.

4 USB hub

The USB hub/port of the monitor is disabled in off mode.

The connected USB devices can work normally in the standby & on mode.

5 USB charging

This display has USB ports capable of standard power output including some with USB Charging function (identifiable with power icon ). You can use these ports to charge your Smart phone or power your external HDD, for example. The display must be powered ON at all times to be able to use this function.

Note

If you Turn OFF your monitor via the power switch at any given time, all the USB ports will power OFF.

Warning





USB 2.4Ghz wireless devices, such as, wireless mouse, keyboard, and headphones, maybe have interference by USB3.2 or higher version, the high-speed signal devices, which may result in a decreased efficiency of the radio transmission. Should this happen, please try the following methods to help reduce the effects of interference.

- Try to keep USB2.0 receivers away from USB3.2 or higher version of connection port.
- Use a standard USB extension cable or USB hub to increase the space between your wireless receiver and the USB3.2 or higher version of connection port.

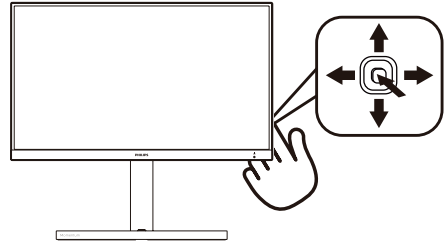
2.2 Operating the monitor

1 Description of the control buttons









1		Press more than 3 seconds to switch display power OFF. Press to switch display power ON.
2		Access the OSD menu. Confirm the OSD adjustment.
3		Adjust the Game Setting.
		Adjust the OSD menu.
4		Change the signal input source
		Adjust the OSD menu.
5		SmartImage Game menu: There are multiple selections: FPS, Racing, RTS, Gamer 1, Gamer 2, LowBlue Mode, SmartUniformity, Off. When the monitor receives HDR signal, SmartImage will show HDR menu. There are multiple selections: HDR Game, HDR Movie, HDR Photo, Personal, and Off.
		Return to previous OSD level.

2. Setting up the monitor

2 Description of the On Screen Display

What is On-Screen Display (OSD)?

On-Screen Display (OSD) is a feature in all Philips LCD monitors. It allows an end user to adjust screen performance or select functions of the monitors directly through an on-screen instruction window. A user friendly on screen display interface is shown as below:

 Ambiglow	Ambiglow	Off
	Single Color	White
 Game Setting	Position	All-around
	Brightness	Bright
 LowBlue Mode		
 Input		
 Picture		
 SmartSize		

Basic and simple instruction on the control keys

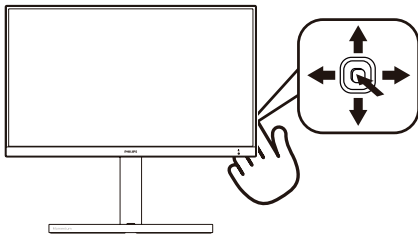

To access the OSD menu on this Philips display simply use the single toggle button on the rear side of the display. The single button operates like a joystick. To move the cursor, simply toggle the button in four directions. Press the button to select desired option.

The OSD Menu

Below is an overall view of the structure of the On-Screen Display. You can use this as a reference when you want to work your way around the different adjustments later on.

Main menu	Sub menu		
Ambiglow	Ambiglow	Follow Video, Auto, Single Color, Off	
	Single Color	White, Red, Rose, Magenta, Violet, Blue, Azure, Cyan, Aquamarine, Green, Chartreuse, Yellow, Orange	
	Position	All-around, Top/Left/Right, Left/Right, Bottom	
	Brightness	Bright, Brighter, Brightest	
	Game Setting	MPRT	On, Off
		MPRT Level	0-20
		Crosshair	On, Off
		Low Input Lag	On, Off
		SmartResponse	Off, Fast, Faster, Fastest
		SmartFrame	On, Off
		Size: 1, 2, 3, 4, 5, 6, 7	
		Brightness: 0-100	
		Contrast: 0-100	
		H. position	
		V. position	
		1,2,3,4	
Low Blue Mode	On		
	Off		
Input	1 HDMI 2.0		
	2 HDMI 2.0		
	DisplayPort		
Picture	SmartImage	FPS/Racing/RTS/Gamer1/Gamer2/LowBlue Mode/SmartUniformity/Off	
	SmartImage HDR	HDR Game/ HDR Movie/ HDR Photo/ Personal/Off	
	Brightness	0-100	
	Contrast	0-100	
	Sharpness	0-100	
	SmartContrast	On, Off	
	Gamma	1.8, 2.0, 2.2, 2.4, 2.6	
	Pixel Orbiting	On, Off	
	Over Scan	On, Off	
	SmartSize	Panel Size	17" (5:4)
		19" (5:4)	
		19" W (16:10)	
		22" W (16:10)	
		18.5" W (16:9)	
		19.5" W (16:9)	
		20" W (16:9)	
		21.5" W (16:9)	
		23" W (16:9)	
		24" W (16:9)	
	27" W (16:9)		
	1:1		
Aspect			
Audio	Volume	0-100	
	Mute	On, Off	
	DTS Sound	Standard/Game/Classical/Rock/Live/Theater/Off	
	TruVolume HD	On, Off	
	EQ	100Hz, 300Hz, 1KHz, 3KHz, 10KHz	
Color	Color Temperature	Native, 5000K, 6500K, 7500K, 8200K, 9300K, 11500K	
	sRGB		
	User Define	Red: 0-100 Green: 0-100 Blue: 0-100	
Language		English, Deutsch, Español, Ελληνική, Français, Italiano, Magyar, Nederlands, Português, Português do Brasil, Polski, Русский, Svenska, Suomi, Türkçe, Čeština, Українська, 简体中文, 繁體中文, 日本語, 한국어	
OSD Settings	Horizontal	0-100	
	Vertical	0-100	
	Transparency	Off, 1, 2, 3, 4	
	OSD Time Out	5s, 10s, 20s, 30s, 60s	
Setup	Resolution Notification	On, Off	
	Reset	Yes, No	
	Information		

2. Setting up the monitor

Note

- **MPRT:** To reduce motion blur, LED backlight will strobe synchronously with screen refresh, which may cause noticeable brightness change.
- MPRT is to adjust brightness for blur reduction, so cannot adjust brightness while MPRT is turned on.
- MPRT is gaming-optimized mode. Turn on MPRT may cause noticeable screen flickering. It is recommended to turn off when you are not using the gaming function.

3 Resolution notification

This monitor is designed for optimal performance at its native resolution, 3840 x 2160 . When the monitor is powered on at a different resolution, an alert is displayed on screen: Use 3840 x 2160 for best results.

Display of the native resolution alert can be switched off from Setup in the OSD (On Screen Display) menu.

4 Physical Function

Tilt

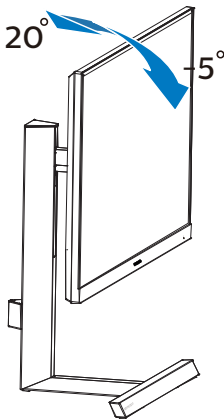

Swivel

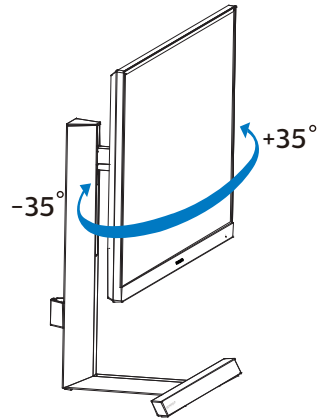

Height adjustment

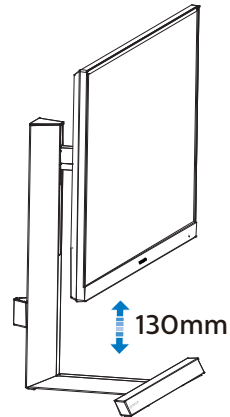

Warning

- To avoid potential screen damage, such as panel peeling, ensure that the monitor does not tilt downward by more than -5 degrees.
- Do not press the screen while adjusting the angle of the monitor. Grasp only the bezel.

2.3 Remove the Base Assembly for VESA Mounting

Before you start disassembling the Display base, please follow the instructions below to avoid any possible damage or injury.

1. Place the monitor face down on a smooth surface. Pay attention not to scratch or damage the screen.

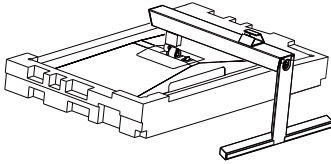

2. While keeping the release button pressed, tilt the stand and slide it out.

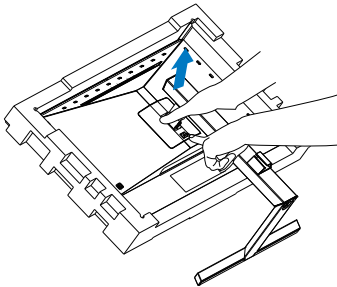

Note

This monitor accepts a 100mm x 100mm VESA-Compliant mounting interface. VESA Mounting Screw M4. Always contact manufacturer for wall-mount installation.

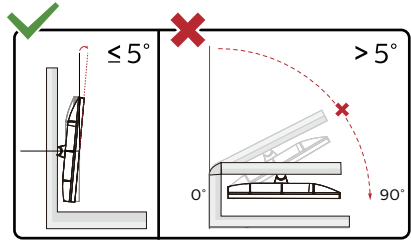
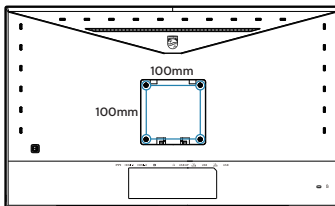

* Display design may differ from those illustrated.

Warning

- To avoid potential screen damage, such as panel peeling, ensure that the monitor does not tilt downward by more than -5 degrees.
- Do not press the screen while adjusting the angle of the monitor. Grasp only the bezel.

3. Image Optimization

3.1 SmartImage

1 What is it?

SmartImage provides presets that optimize display for different types of content, dynamically adjusting brightness, contrast, color and sharpness in real time. Whether you're working with text applications, displaying images or watching a video, Philips SmartImage delivers great optimized monitor performance.

2 Why do I need it?

You want a monitor that delivers optimized display all your favorite types of content, SmartImage software dynamically adjust brightness, contrast, color and sharpness in real time to enhance your monitor viewing experience.

3 How does it work?

SmartImage is an exclusive, leading edge Philips technology that analyzes the content displayed on your screen. Based on a scenario you select, SmartImage dynamically enhances the contrast, color saturation and sharpness of images to enhance the contents being displayed - all in real time with the press of a single button.

4 How to enable SmartImage?

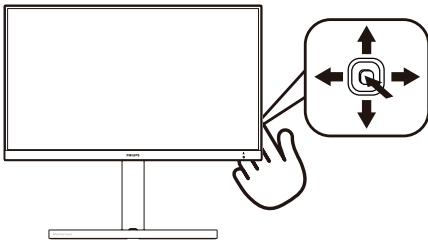

1. Toggle to the left to launch the SmartImage on screen display.
2. Toggle to the up or down to select among FPS, Racing, RTS, Gamer1, Gamer2, LowBlue Mode, SmartUniformity and Off.
3. The SmartImage on screen display will remain on screen for 5 seconds, or you can also toggle to the right to make confirmation.

There are 8 modes to select: FPS, Racing, RTS, Gamer1, Gamer2, LowBlue Mode, SmartUniformity and Off.

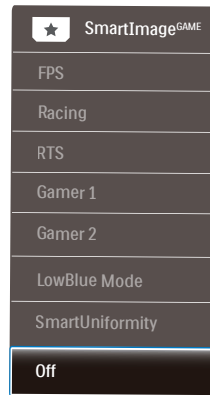

- **FPS:** For playing FPS (First Person Shooters) games. Improves dark theme black level details.
- **Racing:** For playing Racing games. Provides fastest response time and high color saturation.
- **RTS:** For playing RTS (Real Time Strategy) games, a user-selected portion can be highlighted for RTS games (through SmartFrame). The picture quality can be adjusted for the highlighted portion.
- **Gamer 1:** User's preference settings saved as Gamer 1.
- **Gamer 2:** User's preference settings saved as Gamer 2.

3. Image Optimization

- **LowBlue Mode:** LowBlue Mode for easy on-the-eyes productivity. Studies have shown that just as ultra-violet rays can cause eye damage, shortwave length blue light rays from LED displays can cause eye damage and affect vision over time. Developed for wellbeing, Philips LowBlue Mode setting uses a smart software technology to reduce harmful shortwave blue light.
- **Smartuniformity:** Fluctuations in brightness on different parts of a screen are a common phenomenon among LCD displays. Typical uniformity is measured around 75-80%. By enabling Philips SmartUniformity feature, display uniformity is increased to above 95%. This produces more consistent and true images.
- **Off:** No optimization by SmartImage^{GAME}.

When this display receives HDR signal from the connected device, select a picture mode that best fits your needs.

There are 5 modes to select: HDR Game, HDR Movie, HDR Photo, Personal, and Off.

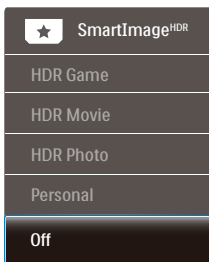

- **HDR Movie:** Ideal setting for watching HDR movie. Deliver better contrast and brightness for more realistic and immerse viewing experience.
- **HDR Photo:** Enhancing red, green, and blue for true-to-life visuals.
- **Personal:** Customize available settings in picture menu.
- **Off:** No optimization by SmartImage HDR.

Note

To switch off HDR function, please disable from Input device and its content. Inconsistent HDR settings between input device and monitor may cause unsatisfying images.

- **HDR Game:** Ideal setting to optimize for playing video games. With brighter white and darker black, the gaming scene is vivid and revealing more details, easily spot enemies hiding in the dark corner and shadows.

3.2 SmartContrast

1 What is it?

Unique technology that dynamically analyzes displayed content and automatically optimizes a display's contrast ratio for maximum visual clarity and viewing enjoyment, stepping up backlighting for clearer, crisper and brighter images or dimming backlighting for clear display of images on dark backgrounds.

2 Why do I need it?

You want the very best visual clarity and viewing comfort for every type of content. SmartContrast dynamically controls contrast and adjusts backlighting for clear, crisp, bright gaming and video images or displays clear, readable text for office work. By reducing your display's power consumption, you save on energy costs and extend the lifetime of your display.

3 How does it work?

When you activate SmartContrast, it will analyse the content you are displaying in real time to adjust colors and control backlight intensity. This function will dynamically enhance contrast for a great entertainment experience when viewing videos or playing games.

4. Ambiglow

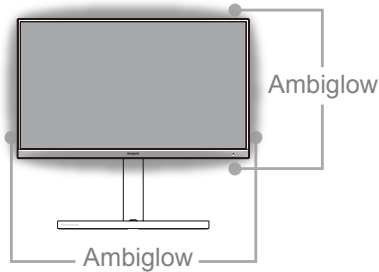

1 What is it?

Ambiglow adds a new dimension to your viewing experience. The innovative Ambiglow processor continuously adjusts the overall color and brightness of the light to match the on screen image. User options like Auto mode, 3 step brightness settings allow to adjust the ambiance to your liking and available wall surface. Whether you are playing games, or watching movies, Philips Ambiglow offers you a unique and immersive viewing experience.

2 How does it work?

It is recommended that you dim the lighting conditions in your room for maximum effect. Ensure that Ambiglow is set to “on” mode. Start a movie, or play a game from your computer. The monitor will react with appropriate colors creating a halo effect, overall matching the image on the screen. You can also manually select Bright, Brighter, Brightest mode or ambiglow function off mode depending on your preference which helps reduce eye fatigue under prolonged usage.

3 How to enable Ambiglow

Ambiglow function can be selected through OSD menu by pressing right button to choose and pressing right button again to confirm the selection:

1. Press right button.
2. Select [Ambiglow].
3. To switch Ambiglow on, and choose a lighting mode, select [Follow Video], [Auto] or [Single Color].

	Ambiglow	Off
 Ambiglow	Single Color	White
 Game Setting	Position	All-around
	Brightness	Bright
 LowBlue Mode		
 Input		
 Picture		
 SmartSize		

5. HDR

HDR Settings in Windows10 system.

Steps

1. Right click on the desktop, enter to Display settings.
2. Select the display/monitor.
3. Adjust resolution to 3840 x 2160.
4. Turn the “HDR and WCG” to on mode.
5. Adjust Brightness for SDR content.

Note

Windows10 edition is required; always upgrade to the most updated version. Below linkage is for the further more information from mircrosoft official website.

<https://support.microsoft.com/en-au/help/4040263/windows-10-hdr-advanced-color-settings>

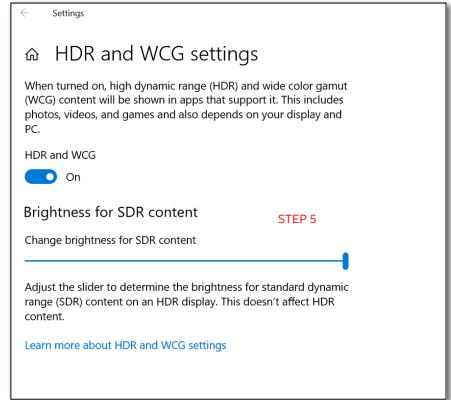

Note

To switch off HDR function, please disable from Input device and its content. Inconsistent HDR settings between input device and monitor may cause unsatisfying images.

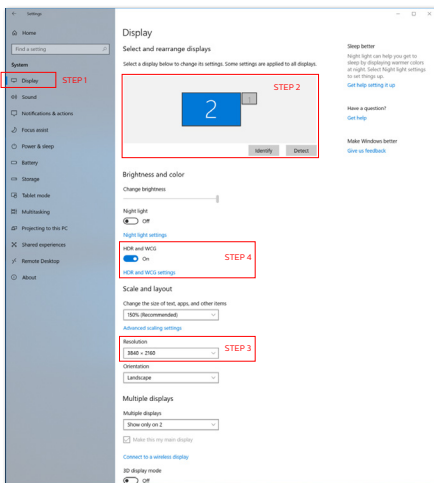

6. AMD FreeSync™



PC gaming has long been an imperfect experience because GPUs and monitors update at different rates. Sometimes a GPU can render many new pictures during a single update of the monitor, and the monitor will show pieces of each picture as a single image. This is called “tearing.” Gamers can fix tearing with a feature called “v-sync,” but the image can become jerky as the GPU waits on the monitor to call for an update before delivering new pictures.

The responsiveness of mouse input and overall frames per second are reduced with v-sync, too. AMD FreeSync™ technology eliminates all of these problems by letting the GPU update the monitor the moment a new picture is ready, leaving gamers with unbelievably smooth, responsive, tearing-free games.

Followed by the graphic card that are compatible.

- AMD Radeon R7 260X
- AMD Radeon R7 260
- Processor A-Series Desktop and Mobility APUs
 - AMD A10-7890K
 - AMD A10-7870K
 - AMD A10-7850K
 - AMD A10-7800
 - AMD A10-7700K
 - AMD A8-7670K
 - AMD A8-7650K
 - AMD A8-7600
 - AMD A6-7400K
- Operating system
 - Windows 10/8.1/8/7
- Graphic Card: R9 290/300 Series & R7 260 Series
 - AMD Radeon R9 300 Series
 - AMD Radeon R9 Fury X
 - AMD Radeon R9 360
 - AMD Radeon R7 360
 - AMD Radeon R9 295X2
 - AMD Radeon R9 290X
 - AMD Radeon R9 290
 - AMD Radeon R9 285

7. Technical Specifications

Picture/Display	
Monitor Panel Type	IPS Technology
Backlight	W-LED
Panel Size	27" W (68.6 cm)
Aspect Ratio	16:9
Pixel Pitch	0.1554 (H) mm x 0.1554 (V) mm
Contrast Ratio (typ.)	1000:1
Recommended Resolution	3840 x 2160 @ 60Hz
Viewing Angle	178° (H) / 178° (V) @ C/R > 10
Picture Enhancement	SmartImage Game / SmartImage HDR
Vertical Refresh Rate	23 Hz - 75 Hz
Horizontal Frequency	30 KHz - 140 KHz
sRGB	YES
Color Gamut	YES
SmartUniformity	YES
Delta E	YES
LowBlue Mode	YES
Display Colors	1.07B (8 bit + FRC)
Flicker free	YES
HDR	YES
AMD FreeSync™	YES
Ambiglow	YES (4-sides Ambiglow)
Connectivity	
Signal Input	HDMI 2.0 x 2, DisplayPort 1.4 x 1
USB	USB-B x 1 (upstream), USB3.2 x 4 (including 2 fast charger)
Input Signal	Separate Sync
Audio In/Out	Headphone out
Convenience	
Built-in speaker	5W x 2 with DTS sound
OSD Languages	English, German, Spanish, Greek, French, Italian, Hungarian, Dutch, Portuguese, Brazil Portuguese, Polish, Russian, Swedish, Finnish, Turkish, Czech, Ukranian, Simplified Chinese, Traditional Chinese, Japanese, Korean
Other Convenience	VESA mount(100 x 100 mm), Kensington Lock
Plug & Play Compatibility	DDC/CI, sRGB, Windows 10/8.1/8/7, Mac OSX
Stand	
Tilt	-5 / +20 degree
Swivel	-35 / +35 degree
Height adjustment	130 mm

7. Technical Specifications

Power			
Consumption	AC Input Voltage at 100VAC , 50Hz	AC Input Voltage at 115VAC , 60Hz	AC Input Voltage at 230VAC, 50Hz
Normal Operation	35.2 W (typ.)	35.1 W (typ.)	33.9 W (typ.)
Sleep (Standby mode)	0.5 W	0.5 W	0.5 W
Off mode	0.3 W	0.3 W	0.3 W
Heat Dissipation*	AC Input Voltage at 100VAC , 50Hz	AC Input Voltage at 115VAC , 60Hz	AC Input Voltage at 230VAC , 50Hz
Normal Operation	120.1 BTU/hr (typ.)	119.8 BTU/hr (typ.)	115.7 BTU/hr (typ.)
Sleep (Standby mode)	1.71 BTU/hr	1.71 BTU/hr	1.71 BTU/hr
Off mode	1.02 BTU/hr	1.02 BTU/hr	1.02 BTU/hr
Power LED indicator	On mode: White, Standby / Sleep mode: White (blinking)		
Power Supply	External, 100-240 VAC, 50-60 Hz		
Dimension			
Product with stand (WxHxD)	614 x 567 x 251 mm		
Product without stand (WxHxD)	614 x 370 x 75 mm		
Product with packaging (WxHxD)	730 x 475 x 224 mm		
Weight			
Product with stand	6.74 kg		
Product without stand	4.53 kg		
Product with packaging	9.22 kg		
Operating Condition			
Temperature range (operation)	0°C to 40 °C		
Relative humidity (operation)	20% to 80%		
Atmospheric pressure (operation)	700 to 1060hPa		
Temperature range (Non-operation)	-20°C to 60°C		
Relative humidity (Non-operation)	10% to 90%		
Atmospheric pressure (Non-operation)	500 to 1060hPa		

7. Technical Specifications

Environmental	
RoHS	Yes
Packaging	100 % recyclable
Specific Substances	100 % PVC BFR free housing
Cabinet	
Color	Black
Finish	Glossy and Textured

Note

1. This data is subject to change without notice. Go to www.philips.com/support to download the latest version of leaflet.
2. SmartUniformity and Delta E information sheets are included in the box.

7.1 Resolution & Preset Modes

1 Maximum Resolution
3840 x 2160 @ 60 Hz

2 Recommended Resolution
3840 x 2160 @ 60 Hz

H. freq (kHz)	Resolution	V. freq (Hz)
31.47	640 x 480	59.94
35.16	800 x 600	56.00
48.36	1024 x 768	60.00
44.77	1280 x 720	59.86
55.94	1440 x 900	59.89
65.29	1680 x 1050	59.95
67.50	1920 x 1080	60.00
133.29	1920 x 2160	60.00
88.19	2560 x 1440	60.00
67.5	3840 x 2160	30.00
135	3840 x 2160	60.00

Note

- Please notice that your display works best at native resolution of 3840 x 2160 . For best display quality, please follow this resolution recommendation.
- The highest supporting screen resolution on HDMI/DP is 3840 x 2160 , but it always depends on your capability of graphics card and BluRay/video players.

8. Power Management

If you have VESA DPM compliance display card or software installed in your PC, the monitor can automatically reduce its power consumption when not in use. If an input from a keyboard, mouse or other input device is detected, the monitor will 'wake up' automatically. The following table shows the power consumption and signaling of this automatic power saving feature:

Power Management Definition					
VESA Mode	Video	H-sync	V-sync	Power Used	LED Color
Active	ON	Yes	Yes	35.1 W (typ.), 92.0 W (max.)	White
Sleep (Standby mode)	OFF	No	No	0.5 W	White (blink)
Off mode	OFF	-	-	0.3 W	OFF

The following setup is used to measure power consumption on this monitor.

- Native resolution: 3840 x 2160
- Contrast: 50%
- Brightness: 70%
- Color temperature: 6500k with full white pattern

Note

This data is subject to change without notice.

9. Customer care and warranty

9.1 Philips' Flat Panel Monitors Pixel Defect Policy

Philips strives to deliver the highest quality products. We use some of the industry's most advanced manufacturing processes and practice stringent quality control. However, pixel or sub pixel defects on the TFT Monitor panels used in flat panel monitors are sometimes unavoidable. No manufacturer can guarantee that all panels will be free from pixel defects, but Philips guarantees that any monitor with an unacceptable number of defects will be repaired or replaced under warranty. This notice explains the different types of pixel defects and defines acceptable defect levels for each type. In order to qualify for repair or replacement under warranty, the number of pixel defects on a TFT Monitor panel must exceed these acceptable levels. For example, no more than 0.0004% of the sub pixels on a monitor may be defective. Furthermore, Philips sets even higher quality standards for certain types or combinations of pixel defects that are more noticeable than others. This policy is valid worldwide.

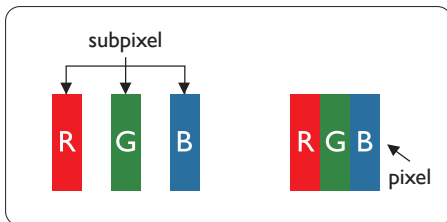

Pixels and Sub pixels

A pixel, or picture element, is composed of three sub pixels in the primary colors

of red, green and blue. Many pixels together form an image. When all sub pixels of a pixel are lit, the three colored sub pixels together appear as a single white pixel. When all are dark, the three colored sub pixels together appear as a single black pixel. Other combinations of lit and dark sub pixels appear as single pixels of other colors.

Types of Pixel Defects

Pixel and sub pixel defects appear on the screen in different ways. There are two categories of pixel defects and several types of sub pixel defects within each category.

Bright Dot Defects

Bright dot defects appear as pixels or sub pixels that are always lit or 'on'. That is, a bright dot is a sub-pixel that stands out on the screen when the monitor displays a dark pattern. There are the types of bright dot defects.

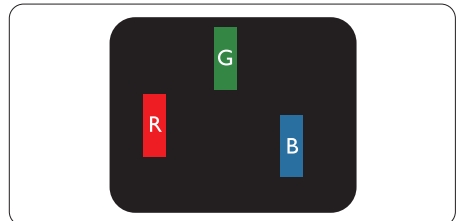

One lit red, green or blue sub pixel.

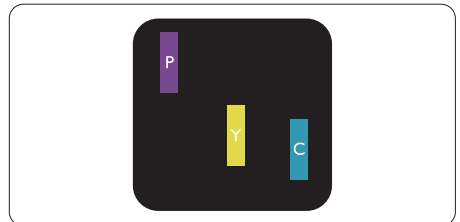

Two adjacent lit sub pixels:

- Red + Blue = Purple
- Red + Green = Yellow
- Green + Blue = Cyan (Light Blue)

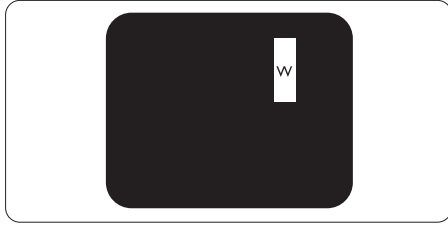

Three adjacent lit sub pixels (one white pixel).

Note

A red or blue bright dot must be more than 50 percent brighter than neighboring dots while a green bright dot is 30 percent brighter than neighboring dots.

Black Dot Defects

Black dot defects appear as pixels or sub pixels that are always dark or 'off'. That is, a dark dot is a sub-pixel that stands out on the screen when the monitor displays a light pattern. These are the types of black dot defects.

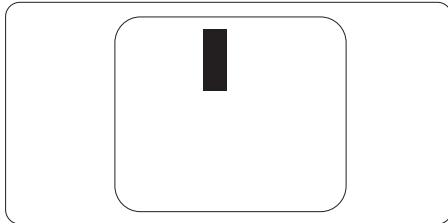

Proximity of Pixel Defects

Because pixel and sub pixels defects of the same type that are near to one another may be more noticeable, Philips also specifies tolerances for the proximity of pixel defects.

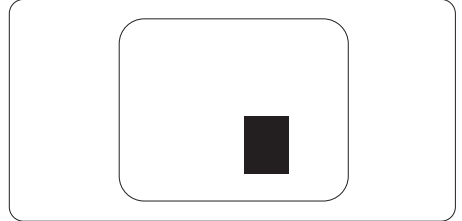

Pixel Defect Tolerances

In order to qualify for repair or replacement due to pixel defects during the warranty period, a TFT Monitor panel in a Philips flat panel monitor must have pixel or sub pixel defects exceeding the tolerances listed in the following tables.

9. Customer care and warranty

BRIGHT DOT DEFECTS	ACCEPTABLE LEVEL
1 lit subpixel	2
2 adjacent lit subpixels	1
3 adjacent lit subpixels (one white pixel)	0
Distance between two bright dot defects*	>15 mm
Total bright dot defects of all types	3

BLACK DOT DEFECTS	ACCEPTABLE LEVEL
1 dark subpixel	5 or fewer
2 adjacent dark subpixels	2
3 adjacent dark subpixels	0
Distance between two black dot defects*	>15 mm
Total black dot defects of all types	5 or fewer

TOTAL DOT DEFECTS	ACCEPTABLE LEVEL
Total bright or black dot defects of all types	5 or fewer

Note

1 or 2 adjacent sub pixel defects = 1 dot defect

9.2 Customer Care & Warranty

For warranty coverage information and additional support requirements valid for your region, please visit www.philips.com/support website for details or contact your local Philips Customer Care Center.

For Warranty Period please refer to Warranty Statement in Regulation & Service Information Manual.

For extended warranty, if you would like to extend your general warranty period, an Out of Warranty service package is offered via our Certified Service Center.

If you wish to make use of this service, please be sure to purchase the service within 30 calendar days of your original purchase date. During the extended warranty period, the service includes pickup, repair and return service, however the user will be responsible for all costs accrued.

If the Certified Service Partner cannot perform the required repairs under the offered extended warranty package, we will find alternative solutions for you, if possible, up to the extended warranty period you have purchased.

Please contact our Philips Customer Service Representative or local contact center (by Consumer care number) for more details.

Philips Customer Care Center number listed below.

• Local Standard Warranty Period	• Extended Warranty Period	• Total Warranty Period
• Depend on different Regions	• + 1 Year	• Local Standard warranty period +1
	• + 2 Years	• Local Standard warranty period +2
	• + 3 Years	• Local Standard warranty period +3

**Proof of original purchase and extended warranty purchase required.

Note

Please refer to Regulation & Service Information Manual for regional service hotline, which is available on the Philips website support page.

10. Troubleshooting & FAQs

10.1 Troubleshooting

This page deals with problems that can be corrected by a user. If the problem still persists after you have tried these solutions, contact Philips customer service representative.

1 Common Problems

No Picture (Power LED not lit)

- Make sure the power cord is plugged into the power outlet and into the back of the monitor.
- First, ensure that the power button on the rear side of the display is in the OFF position, then press it to the ON position.

No Picture (Power LED is White)

- Make sure the computer is turned on.
- Make sure the signal cable is properly connected to your computer.
- Make sure the monitor cable has no bent pins on the connect side. If yes, repair or replace the cable.
- The Energy Saving feature may be activated

Screen says

Check cable connection

- Make sure the monitor cable is properly connected to your computer. (Also refer to the Quick Start Guide).
- Check to see if the monitor cable has bent pins.

- Make sure the computer is turned on.

Visible signs of smoke or sparks

- Do not perform any troubleshooting steps
- Disconnect the monitor from mains power source immediately for safety
- Contact with Philips customer service representative immediately.

2 Imaging Problems

Image vibrates on the screen

- Check that the signal cable is properly securely connected to the graphics board or PC.

Image appears blurred, indistinct or too dark

- Adjust the contrast and brightness on On-Screen Display.

An "after-image", "burn-in" or "ghost image" remains after the power has been turned off.

- Uninterrupted display of still or static images over an extended period may cause "burn-in", also known as "after-imaging" or "ghost imaging", on your screen. "Burn-in", "after-imaging", or "ghost imaging" is a well-known phenomenon in monitor panel technology. In most cases, the "burned in" or "after-imaging" or "ghost imaging" will disappear gradually over a period of time after the power has been switched off.
- Always activate a moving screen saver program when you leave your monitor unattended.
- Always activate a periodic screen refresh application if your monitor will display unchanging static content.

- Failure to activate a screen saver, or a periodic screen refresh application may result in severe “burn-in” or “after-image” or “ghost image” symptoms that will not disappear and cannot be repaired. The damage mentioned above is not covered under your warranty.

Image appears distorted. Text is fuzzy or blurred.

- Set the PC’s display resolution to the same mode as monitor’s recommended screen native resolution.

Green, red, blue, dark, and white dots appears on the screen

- The remaining dots are normal characteristic of the liquid crystal used in today’s technology, Please refer the pixel policy for more detail.

For further assistance, refer to the Service contact information listed in Regulation & Service Information Manual and contact Philips customer service representative.

3 Audio problem

No sound

- Check if audio cable is connected to PC and monitor correctly.
- Ensure audio is not muted. Press OSD “Menu”, select “Audio” then “Mute”. Check it on “Off” position.
- Press “Volume” in OSD main control to adjust the volume.

10.2 General FAQs

Q1: When I install my monitor what should I do if the screen shows 'Cannot display this video mode'?

Ans.: Recommended resolution for this monitor: 3840 x 2160.

- Unplug all cables, then connect your PC to the monitor that you used previously.
- In the Windows Start Menu, select Settings/Control Panel. In the Control Panel Window, select the Display icon. Inside the Display Control Panel, select the 'Settings' tab. Under the setting tab, in box labelled 'desktop area', move the sidebar to 3840 x 2160 pixels.
- Open 'Advanced Properties' and set the Refresh Rate to 60 Hz, then click OK.
- Restart your computer and repeat step 2 and 3 to verify that your PC is set at 3840 x 2160 .
- Shut down your computer, disconnect your old monitor and reconnect your Philips monitor.
- Turn on your monitor and then turn on your PC.

Q2: What are the .inf and .icm files? How do I install the drivers (.inf and .icm)?

Ans.: These are the driver files for your monitor. Your computer may ask you for monitor drivers (.inf and .icm files) when you first install your monitor. Follow the instructions in your user manual, monitor drivers (.inf and .icm files) will be installed automatically.

Q3: How do I adjust the resolution?

Ans.: Your video card/graphic driver and monitor together determine the available resolutions. You can select the desired resolution under Windows® Control Panel with the "Display properties".

Q4: What if I get lost when I am making monitor adjustments via OSD?

Ans.: Simply press the  button, then select [Reset] to recall all the original factory settings.

Q5: Is the monitor screen resistant to scratches?



Ans.: In general it is recommended that the panel surface is not subjected to excessive shocks and is protected from sharp or blunt objects. When handling the monitor, make sure that there is no pressure or force applied to the panel surface side. This may affect your warranty conditions.

Q6: How should I clean the monitor surface?

Ans.: For normal cleaning, use a clean, soft cloth. For extensive cleaning, please use isopropyl alcohol. Do not use other solvents such as ethyl alcohol, ethanol, acetone, hexane, etc.

Q7: Can I change the color setting of my monitor?

Ans.: Yes, you can change your color setting through OSD control as the following procedures:

- Press  button to show the OSD (On Screen Display) menu
- Press  button to select the option [Color] then press  button to

enter color setting, there are three settings as below.

1. Color Temperature: The seven settings are Native, 5000K, 6500K, 7500K, 8200K, 9300K and 11500K. With settings in the 5000K range the panel appears "warm, with a red-white color tone", while a 11500K temperature yields "cool, bluishwhite toning".
2. sRGB: This is a standard setting for ensuring correct exchange of colors between different device (e.g. digital cameras, monitors, printers, scanners, etc).
3. User Define: The user can choose his/her preference color setting by adjusting red, green, blue color.

Note

A measurement of the color of light radiated by an object while it is being heated. This measurement is expressed in terms of absolute scale, (degrees Kelvin). Lower Kelvin temperatures such as 2004K are red; higher temperatures such as 9300K are blue. Neutral temperature is white, at 6504K.

Q8: Can I connect my monitor to any PC, workstation or Mac?

Ans.: Yes. All Philips monitors are fully compatible with standard PCs, Macs and workstations. You may need a cable adapter to connect the monitor to your Mac system. Please contact your Philips sales representative for more information.

Q9: Are Philips monitors Plug-and-Play?

Ans.: Yes, the monitors are Plug-and-Play compatible with Windows 10/8.1/8/7, Mac OS X

Q10: What is Image Sticking, or Image Burn-in, or After Image, or Ghost Image in monitor panels?

Ans.: Uninterrupted display of still or static images over an extended period may cause "burn-in", also known as "after-imaging" or "ghost imaging", on your screen. "Burn-in", "after-imaging", or "ghost imaging" is a well-known phenomenon in monitor panel technology. In most cases, the "burned in" or "after-imaging" or "ghost imaging" will disappear gradually over a period of time after the power has been switched off.

Always activate a moving screen saver program when you leave your monitor unattended.

Always activate a periodic screen refresh application if your monitor will display unchanging static content.

Warning

Failure to activate a screen saver, or a periodic screen refresh application may result in severe "burn-in" or "after-image" or "ghost image" symptoms that will not disappear and cannot be repaired. The damage mentioned above is not covered under your warranty.

Q11: Why is my Display not showing sharp text, and is displaying jagged characters?

Ans.: Your monitor works best at its native resolution of 3840 x 2160. For best display, please use this resolution.

Q12: Where can I find Regulation & Service Information Manual mentioned in EDFU?

Ans.: Regulation & Service Information Manual can be download on the Philips website support page.



2020 © TOP Victory Investments Ltd. All rights reserved.

This product has been manufactured by and is sold under the responsibility of Top Victory Investments Ltd., and Top Victory Investments Ltd. is the warrantor in relation to this product. Philips and the Philips Shield Emblem are registered trademarks of Koninklijke Philips N.V. and are used under license.

Specifications are subject to change without notice.

Version: 278M1RE1T