

# **Acer LCD Monitor**

## **User Guide**

Copyright © 2020. Acer Incorporated.  
All Rights Reserved.

Acer LCD Monitor User Guide  
Original Issue: 07/2020

Changes may be made periodically to the information in this publication without obligation to notify any person of such revisions or changes. Such changes will be incorporated in new editions of this manual or supplementary documents and publications. This company makes no representations or warranties, either expressed or implied, with respect to the contents hereof and specifically disclaims the implied warranties of merchantability or fitness for a particular purpose.

Record the model number, serial number, purchase date and place of purchase information in the space provided below. The serial number and model number are recorded on the label affixed to your computer. All correspondence concerning your unit should include the serial number, model number and purchase information.

No part of this publication may be reproduced, stored in a retrieval system, or transmitted, in any form or by any means, electronically, mechanically, by photocopy, recording or otherwise, without the prior written permission of Acer Incorporated.

Acer LCD Monitor User Guide

Model number: \_\_\_\_\_  
Serial number: \_\_\_\_\_  
Date of purchase: \_\_\_\_\_  
Place of purchase: \_\_\_\_\_

Acer and the Acer logo are registered trademarks of Acer Incorporated. Other companies' product names or trademarks are used herein for identification purposes only and belong to their respective companies.

# Information for your safety and comfort

---

## Safety instructions

Read these instructions carefully. Keep this document for future reference. Follow all warnings and instructions marked on the product.

## Special notes on LCD monitors

The following are normal with the LCD monitor and do not indicate a problem.

- Due to the nature of the fluorescent light, the screen may flicker during initial use. Turn off the power switch and then turn it on again to make sure the flicker disappears.
- You may find slightly uneven brightness on the screen depending on the desktop pattern you use.
- The LCD screen has 99.99% or more effective pixels. It may include blemishes of 0.01% or less such as a missing pixel or pixel lit all the time.
- Due to the nature of the LCD screen, an afterimage of the previous screen may remain after switching the image, when the same image is displayed for hours. In this case, the screen is recovered slowly by changing the image or turning off the power switch for a few hours.

## Cleaning your monitor

Please carefully follow these guidelines when cleaning the monitor:

- Always unplug the monitor before cleaning.
- Use a soft cloth to wipe the screen and cabinet front and sides.

## Accessibility

Be sure that the power outlet you plug the power cord into is easily accessible and located as close to the equipment operator as possible. When you need to disconnect power from the equipment, be sure to unplug the power cord from the electrical outlet.

## Safe listening

To protect your hearing, follow these instructions.

- Gradually increase the volume until you can hear it clearly and comfortably and without distortion.
- After setting the volume level, do not increase it after your ears have adjusted.
- Limit the amount of time listening to music at high volume.
- Avoid turning up the volume to block out noisy surroundings.
- Turn the volume down if you can't hear people speaking near you.

## Warnings

- Do not use this product near water.
- Do not place this product on an unstable cart, stand or table. If the product falls, it could be seriously damaged.
- Slots and openings are provided for ventilation to ensure reliable operation of the product and to protect it from overheating. These openings must not

be blocked or covered. The openings should never be blocked by placing the product on a bed, sofa, rug or other similar surface. This product should never be placed near or over a radiator or heat register, or in a built-in installation unless proper ventilation is provided.

- Never push objects of any kind into this product through cabinet slots as they may touch dangerous voltage points or short-out parts that could result in a fire or electric shock. Never spill liquid of any kind onto or into the product.
- To avoid damage of internal components and to prevent battery leakage, do not place the product on a vibrating surface.
- Never use it under sporting, exercising, or any vibrating environment which will probably cause unexpected short current or damage internal devices.
- The adapter is only used for this monitor, do not be used for other purposes.
- Your device uses one of the following power supplies:
- Manufacture: DELTA: ADP-180TB F (19.5V/180W)

## Using electrical power

- This product should be operated from the type of power indicated on the marking label. If you are not sure of the type of power available, consult your dealer or local power company.
- Do not allow anything to rest on the power cord. Do not locate this product where people will walk on the cord.
- If an extension cord is used with this product, make sure that the total ampere rating of the equipment plugged into the extension cord does not exceed the extension cord ampere rating. Also, make sure that the total rating of all products plugged into the wall outlet does not exceed the fuse rating.
- Do not overload a power outlet, strip or receptacle by plugging in too many devices. The overall system load must not exceed 80% of the branch circuit rating. If power strips are used, the load should not exceed 80% of the power strip's input rating.
- This product's power cord is equipped with a three-wire grounded plug. The plug only fits in a grounded power outlet. Make sure the power outlet is properly grounded before inserting the power cord plug. Do not insert the plug into a non-grounded power outlet. Contact your electrician for details.

### **Warning!**

The grounding pin is a safety feature. Using a power outlet that is not properly grounded may result in electric shock and/or injury.

### **Note:**

The grounding pin also provides good protection from unexpected noise produced by other nearby electrical devices that may interfere with the performance of this product.

- Use the product only with the supplied power supply cord set. If you need to replace the power cord set, make sure that the new power cord meets the following requirements: detachable type, UL listed/CSA certified, type SPT-2, rated 7 A 125 V minimum, VDE approved or its equivalent, 4.6 meters (15 feet) maximum length.

## Product servicing

Do not attempt to service this product yourself, as opening or removing covers may expose you to dangerous voltage points or other risks. Refer all servicing to qualified service personnel.

Unplug this product from the wall outlet and refer servicing to qualified service personnel when:

- the power cord or plug is damaged, cut or frayed
- liquid was spilled into the product
- the product was exposed to rain or water
- the product has been dropped or the case has been damaged
- the product exhibits a distinct change in performance, indicating a need for service
- the product does not operate normally after following the operating instructions.

### Note:

Adjust only those controls that are covered by the operating instructions, since improper adjustment of other controls may result in damage and will often require extensive work by a qualified technician to restore the product to normal condition.

## Potentially explosive environments

Switch off your device in any area with a potentially explosive atmosphere and obey all signs and instructions. Potentially explosive atmospheres include areas where you would normally be advised to turn off your vehicle engine. Sparks in such areas could cause an explosion or fire resulting in bodily injury or even death. Switch off the device near depots, storage and distribution areas; chemical plants; or where blasting operations are in progress. Areas with a potentially explosive atmosphere are often, but not always, marked. They include below deck on boats, chemical transfer or storage facilities, vehicles using liquefied petroleum gas (such as propane or butane), and areas where the air contains chemicals or particles such as grain, dust or metal powders.

## Additional safety information

Your device and its enhancements may contain small parts. Keep them out of the reach of small children.

## IT Equipment Recycling Information

Acer is strongly committed to environmental protection and views recycling, in the form of salvaging and disposal of used equipment, as one of the company's top priorities in minimizing the burden placed on the environment.

We at Acer are very conscious of the environmental effects of our business and strive to identify and provide the best working procedures to reduce the environmental impact of our products.

For more information and help when recycling, please go to this website:

<https://www.acer-group.com/sustainability/en/our-products-environment.html>

Visit [www.acer-group.com](http://www.acer-group.com) for further information on the features and benefits of our other products.

## Disposal instructions



Do not throw this electronic device into the trash when discarding. To minimize pollution and ensure utmost protection of the global environment, please recycle. For more information on the Waste from Electrical and Electronics Equipment (WEEE) regulations, visit <https://www.acer-group.com/sustainability/en/our-products-environment.html>.

## LCD pixel statement

The LCD unit is produced with high-precision manufacturing techniques. Nevertheless, some pixels may occasionally misfire or appear as black or red dots. This has no effect on the recorded image and does not constitute a malfunction.

Power management statement should be as below.

- Activate display's Sleep mode within 15 minutes of user inactivity.
- Wake the monitor when it is in Active Off mode, move the mouse or press any keyboard key.

## Tips and information for comfortable use

Computer users may complain of eyestrain and headaches after prolonged use. Users are also at risk of physical injury after long hours of working in front of a computer. Long work periods, bad posture, poor work habits, stress, inadequate working conditions, personal health and other factors greatly increase the risk of physical injury.

Incorrect computer usage may lead to carpal tunnel syndrome, tendonitis, tenosynovitis or other musculoskeletal disorders. The following symptoms may appear in the hands, wrists, arms, shoulders, neck or back:

- numbness, or a burning or tingling sensation
- aching, soreness or tenderness
- pain, swelling or throbbing
- stiffness or tightness
- coldness or weakness

If you have these symptoms, or any other recurring or persistent discomfort and/or pain related to computer use, consult a physician immediately and inform your company's health and safety department.

The following section provides tips for more comfortable computer use.

### Finding your comfort zone

Find your comfort zone by adjusting the viewing angle of the monitor, using a footrest, or raising your sitting height to achieve maximum comfort. Observe the following tips:

- refrain from staying too long in one fixed posture
- avoid slouching forward and/or leaning backward
- stand up and walk around regularly to remove the strain on your leg muscles.

## **Taking care of your vision**

Long viewing hours, wearing incorrect glasses or contact lenses, glare, excessive room lighting, poorly focused screens, very small typefaces and low-contrast displays could stress your eyes. The following sections provide suggestions on how to reduce eyestrain.

### **Eyes**

- Rest your eyes frequently.
- Give your eyes regular breaks by looking away from the monitor and focusing on a distant point.
- Blink frequently to keep your eyes from drying out.

### **Display**

- Keep your display clean.
- Keep your head at a higher level than the top edge of the display so your eyes point downward when looking at the middle of the display.
- Adjust the display brightness and/or contrast to a comfortable level for enhanced text readability and graphics clarity.
- Eliminate glare and reflections by:
  - placing your display in such a way that the side faces the window or any light source
  - minimizing room light by using drapes, shades or blinds
  - using a task light
  - changing the display's viewing angle
  - using a glare-reduction filter
  - using a display visor, such as a piece of cardboard extended from the display's top front edge.
- Avoid adjusting your display to an awkward viewing angle.
- Avoid looking at bright light sources, such as open windows, for extended periods of time.

## **Developing good work habits**

Develop the following work habits to make your computer use more relaxing and productive:

- Take short breaks regularly and often.
- Perform some stretching exercises.
- Breathe fresh air as often as possible.
- Exercise regularly and maintain a healthy body.



**Acer Incorporated**  
8F, 88, Sec. 1, Xintai 5th Rd, Xizhi  
New Taipei City 221, Taiwan

## Declaration of Conformity

We,

**Acer Incorporated**

8F, 88, Sec. 1, Xintai 5th Rd., Xizhi, New Taipei City 221, Taiwan

And,

**Acer Italy s.r.l.**

Viale delle Industrie 1/A, 20020 Arese (MI), Italy

Tel: +39-02-939-921, Fax: +39-02 9399-2913

www.acer.it

<b>Product:</b>	<b>LCD Monitor</b>
<b>Trade Name:</b>	<b>Acer</b>
<b>Model Number:</b>	<b>X34</b>
<b>SKU Number:</b>	<b>X34 xxxxxx;</b> <b>(“x” = 0~9, a~z, A~Z, or blank)</b>

We, Acer Incorporated, hereby declare under our sole responsibility that the product described above is in conformity with the relevant Union harmonization legislations as below Directive and following harmonized standards and/or other relevant standards have been applied:

**EMC Directive: 2014/30/EU**

<input checked="" type="checkbox"/> EN55032:2015+AC: 2016 Class B	<input checked="" type="checkbox"/> EN 55024:2010+A1: 2015
<input checked="" type="checkbox"/> EN61000-3-2:2014 Class D	<input checked="" type="checkbox"/> EN61000-3-3:2013

**LVD Directive: 2014/35/EU**

<input checked="" type="checkbox"/> EN 62368-1: 2014+ A11: 2017
---

**RoHS Directive: 2011/65/EU**

<input checked="" type="checkbox"/> EN 50581:2012
---

**ErP Directive: 2009/125/EC**

<input checked="" type="checkbox"/> (EU) 2019/ 2021; EN 50564:2011
--

Year to begin affixing CE marking: 2020.

**RU Jan / Sr. Manager**  
**Acer Incorporated (Taipei, Taiwan)**

**Nov. 12, 2020**

**Date**





**Acer America Corporation**  
333 West San Carlos St., San Jose  
Suite 1500  
CA 95110, U. S. A.  
Tel : 254-298-4000  
Fax : 254-298-4147  
www.acer.com



## **Federal Communications Commission Supplier's Declaration of Conformity**

This device complies with Part 15 of the FCC Rules. Operation is subject to the following two conditions: (1) this device may not cause harmful interference, and (2) this device must accept any interference received, including interference that may cause undesired operation.

The following local Manufacturer /Importer is responsible for this declaration:

<b>Product:</b>	<b>LCD Monitor</b>
<b>Model Number:</b>	<b>X34</b>
<b>SKU Number:</b>	<b>X34 xxxxxx</b> <b>("x" = 0~9, a ~ z, or A ~ Z)</b>
<b>Name of Responsible Party:</b>	<b>Acer America Corporation</b>
<b>Address of Responsible Party:</b>	<b>333 West San Carlos St.</b> <b>Suite 1500</b> <b>San Jose, CA 95110</b> <b>U. S. A.</b>
<b>Contact Person:</b>	<b>Acer Representative</b>
<b>Phone No.:</b>	<b>254-298-4000</b>
<b>Fax No.:</b>	<b>254-298-4147</b>

# Table of Contents

<b>Information for your safety and comfort</b> .....	<b>ii</b>
Safety instructions.....	ii
Special notes on LCD monitors .....	ii
Cleaning your monitor .....	ii
Accessibility .....	ii
Safe listening .....	ii
Warnings.....	ii
Using electrical power .....	iii
Product servicing .....	iv
Potentially explosive environments .....	iv
Additional safety information.....	iv
IT Equipment Recycling Information .....	iv
Disposal instructions .....	v
LCD pixel statement.....	v
Tips and information for comfortable use.....	v
Finding your comfort zone .....	v
Taking care of your vision .....	vi
Developing good work habits .....	vi
<b>Unpacking</b> .....	<b>1</b>
<b>Adjusting the monitor</b> .....	<b>2</b>
Disassembly Velcro.....	2
Height Adjustment.....	2
Tilt .....	3
Swivel.....	3
<b>Wall Mounting</b> .....	<b>4</b>
<b>Monitor introduction</b> .....	<b>5</b>
Connecting the cables .....	5
Connecting the adapter and AC Power cord.....	6
Power saving .....	6
Display Data Channel (DDC) .....	7
Standard timing table.....	9
<b>Using the Shortcut Menu</b> .....	<b>10</b>
Main page .....	10
Hot key1 (default: Modes) .....	10
Hot key2 (default: Brightness) .....	11
Hot key3 (Selecting the input) .....	11
Main Menu.....	11
<b>Troubleshooting</b> .....	<b>19</b>

# Unpacking

---

Please check that the following items are present when you unpack the box, and save the packing materials in case you need to ship or transport the monitor in the future.

LCD monitor

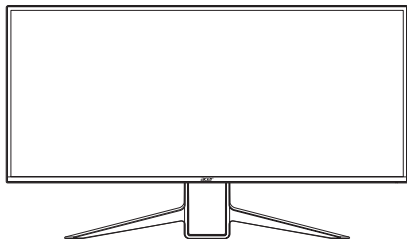

Quick start guide

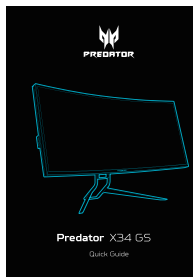

Warranty card

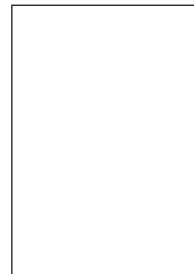

USB cable  
(Optional)

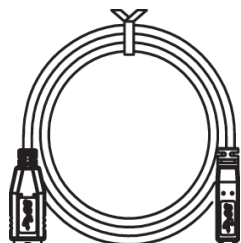

USB Type-C cable  
(Optional)

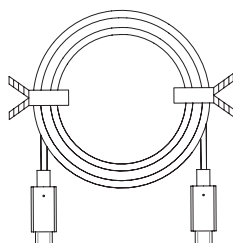

HDMI cable  
(Optional)

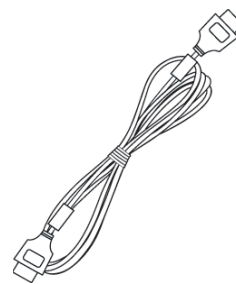

AC Power cord

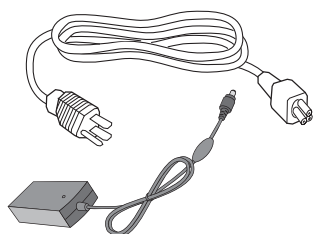

DP Cable (Optional)

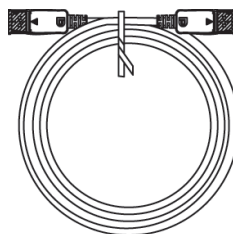

# Adjusting the monitor

- For optimal viewing, we recommend that you look at the full face of the monitor, then adjust the monitor to the angle that is most comfortable for you.
- Hold the stand to prevent the monitor from falling when you change its angle.
- You can adjust the monitor's angle from  $-5^{\circ}$  to  $+35^{\circ}$  and it allows  $\pm 30^{\circ}$  swivel adjustment from either left or right. You can also adjust the monitor's height within 130 mm.

## Disassembly Velcro

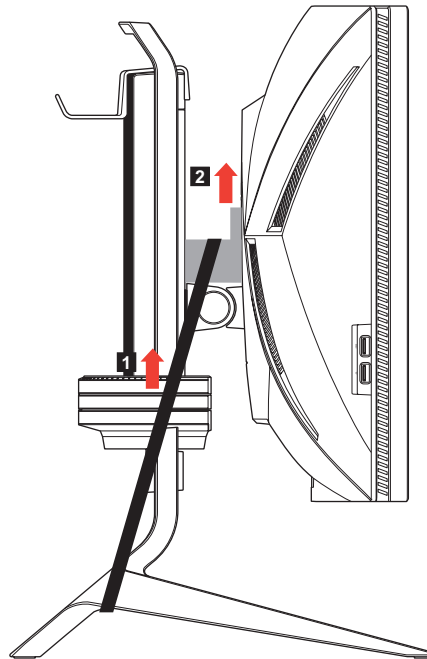

**Note:**

Velcro is used to prevent height adjustment burst and hurting people!

## Height Adjustment

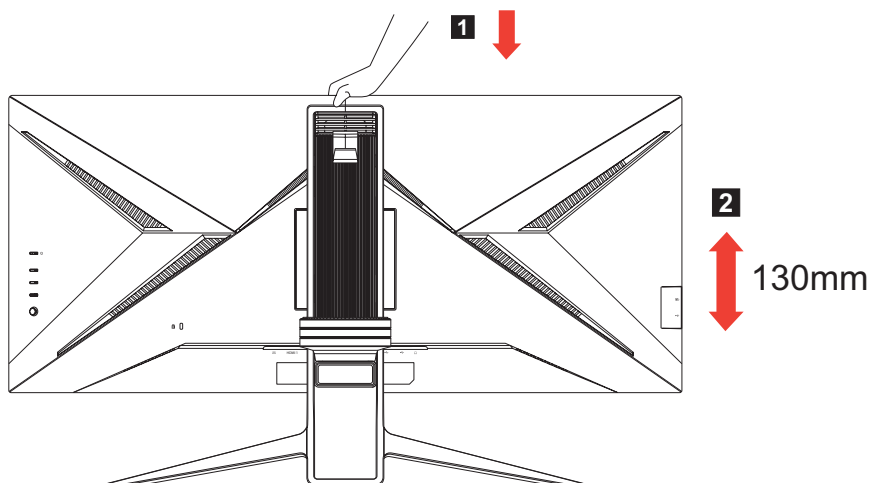

**Note:**

Please adjust the height of the monitor after pressing the top of the monitor.

## Tilt

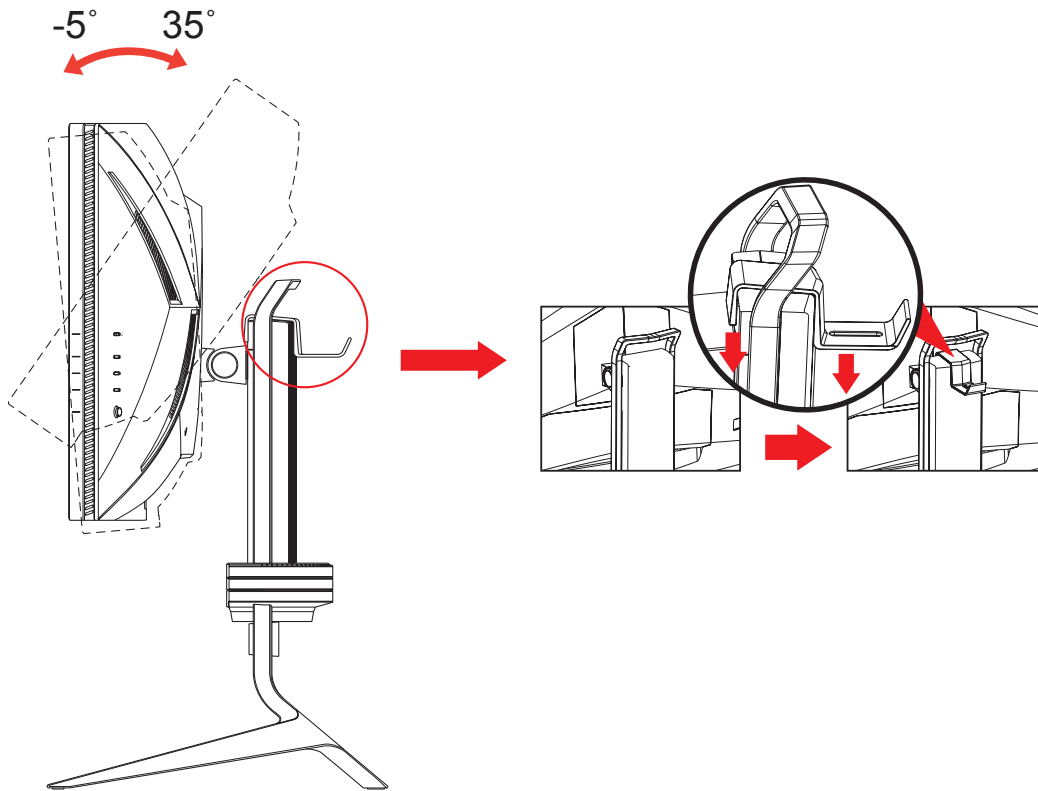

## Swivel

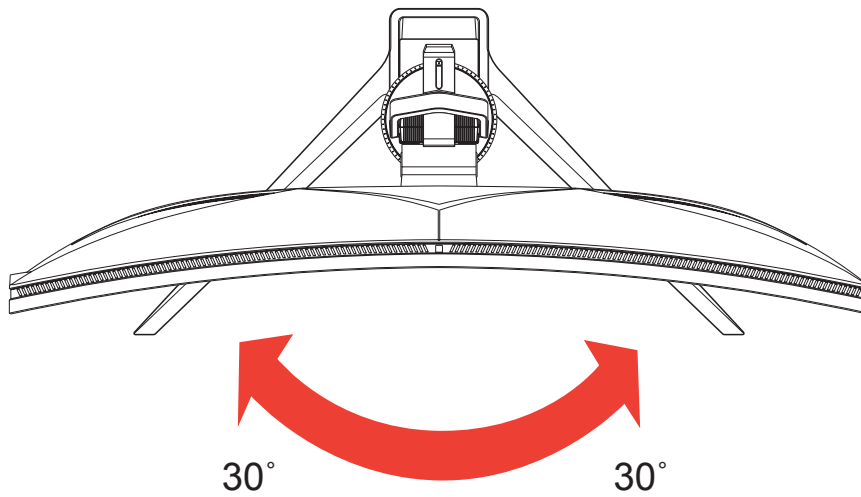

# Wall Mounting

---

Preparing to install an optional wall mount arm.

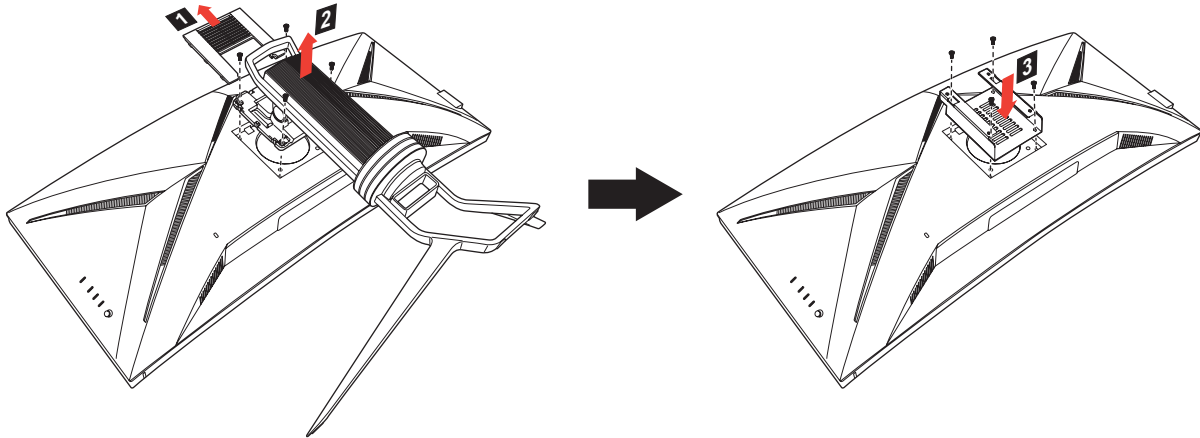

This monitor can be attached to a wall mounting arm you purchase separately. Disconnect power before this procedure. Follow these steps:

1. Remove the base.
2. Follow the manufacturer's instructions to assemble the wall mounting arm.
3. Place the wall mounting arm onto the back of the monitor. Line up the holes of the arm with the holes in the back of the monitor.
4. Insert the 4 screws into the holes and tighten.
5. Reconnect the cables. Refer to the user's manual that came with the optional wall mounting arm for instructions on attaching it to the wall.

**Note:**

- VESA mounting screw holes are not available for all models, please check with the dealer.
- If installing with a wall mounting kit, it is recommended to use VESA mounting kit (100mm x 100mm) with M4 x 10 (L) mm screws to fix your monitor on the wall.

# Monitor introduction

---

## User Controls

 1

 2





 3

 4

 5

## External controls

---

1	Power button	Turns the monitor on/off. Blue indicates power on. Amber indicates standby/ power saving mode.
2	Function key 	a. Press to view Main page. Press again to enter hotkey1 function. b. When the Function Menu is active, press this key to view the basic information for your monitor and current input or reset the custom color settings to the factory defaults.
3	Function key 	a. Press to view Main page. Press again to enter hotkey2 function. b. When the Function Menu is active, press this button to select scenario mode or game mode.
4	Function key 	a. Press to view Main page. Press again to enter Input select function. b. When the Function Menu is active, this button will quit the OSD.
5	Function key 	a. Press to view Main page. Press again to enter next function in the Function Menu. b. The single toggle button on the backside of the Display bezel operates like a joystick. To move the cursor, simply toggle the button in four directions. Press the button to select desired option. Red indicates operable. Grey indicates inoperable.

---

## Connecting the cables

To install the monitor on your host system, please follow the steps below:

1. Turn off your computer and unplug your computer's power cord.
2. Connect the signal cable to the DP (optional) and/or HDMI (optional) input socket of the monitor, and the DP (optional) and/or HDMI (optional) output socket of the graphics card on the computer.
3. Connect the USB Cable (optional):  
Connect the USB 3.0 cable to port.
4. Connect the Type-C Cable (optional):  
Connect the Type-C Cable to port for fast charge.  
Connect the Type-C Cable to port.
5. Insert the monitor power cable into the power port at the back of the monitor.
6. Plug the power cords of your computer and your monitor into a nearby electrical outlet.

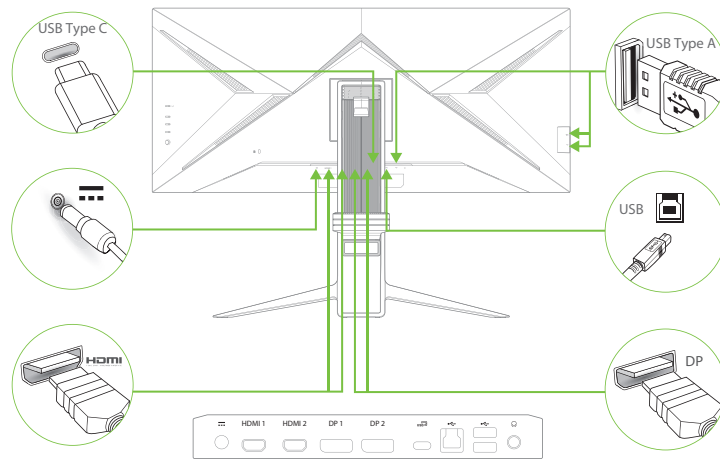

**Note:**

- Audio output is only for audio output model. Please check user manual for more instruction.
- Charging USB devices just in DC on mode.
- Type-C Port can support power delivery charging up to 20V/4.25A.
- The charging port of USB-A can support fast charging up to 5V/1.5A, the others are 5V/0.9A.

## Connecting the adapter and AC Power cord

- Check first to make sure that the power cord you use is the correct type required for your area.
- The monitor has a universal power supply that allows operation in either 100/120 V AC or 220/240 V AC voltage area. No user-adjustment is required.
- Plug one end of the AC power cord to the Adapter, and plug the other end into an AC outlet.

For units using 120 V AC:

- Use a UL-listed cord set, type SVT wire and plug rated 10 A/125 V.

For units using 220/240 V AC:

- Use a cord set consisting of H05VV-F cord and plug rated 10 A/250 V. The cord set should have the appropriate safety approvals for the country in which the equipment will be installed.

## Power saving

The monitor will be driven into “Power Saving” mode by the control signal from the display controller, as indicated by the amber-color power LED.

State	LED Light
ON	Blue
Power Saving Mode	Amber

The power saving states will be kept until a control signal has been detected or the keyboard or mouse is activated. The recovery time from Active OFF state back to ON state is around 3 seconds.



## Display Data Channel (DDC)

To make installation easier, so long as your system supports the DDC protocol, the monitor is able to plug-and-play. The DDC is a communication protocol through which the monitor automatically informs the host system about its capabilities; for example, supported resolutions and corresponding timing. The monitor supports the DDC2B standard.

### 20-pin color display signal cable

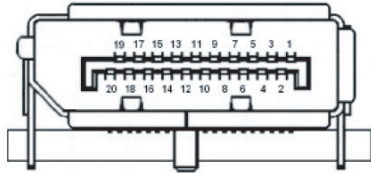

PIN No.	Description	PIN No.	Description
1	ML_Lane 0+	2	GND
3	ML_Lane 0-	4	ML_Lane 1+
5	GND	6	ML_Lane 1-
7	ML_Lane 2+	8	GND
9	ML_Lane 2-	10	ML_Lane 3+
11	GND	12	ML_Lane 3-
13	CONFIG1	14	CONFIG2
15	AUX CH+	16	GND
17	AUX CH-	18	Hot Plug
19	Return	20	DP_PWR

### 19-pin color display signal cable

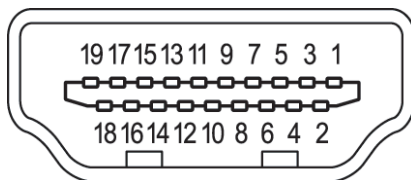

PIN No.	Description	PIN No.	Description
1	TMDS Data2+	2	TMDS Data2 Shield
3	TMDS Data2-	4	TMDS Data1+
5	TMDS Data1 Shield	6	TMDS Data1-
7	TMDS Data0+	8	TMDS Data0 Shield
9	TMDS Data0-	10	TMDS Clock+

PIN No.	Description	PIN No.	Description
11	TMDS Clock Shield	12	TMDS Clock-
13	CEC	14	Reserved (N.C. on device)
15	SCL	16	SDA
17	DDC/CEC Ground	18	+5V Power
19	Hot Plug Detect		

## 24-pin USB Type C cable

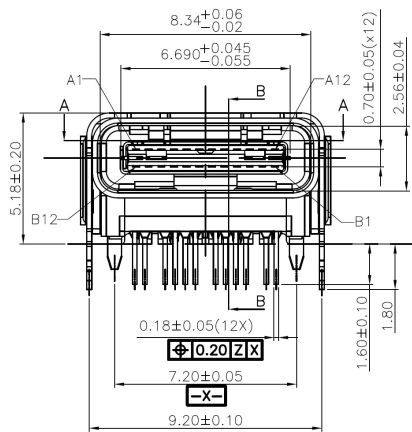

PIN No.	Description	PIN No.	Description
A1	GND	B12	GND
A2	SSTXp1	B11	SSTXp1
A3	SSTXn1	B10	SSTXn1
A4	VBUS	B9	VBUS
A5	CC1	B8	CC1
A6	Dp1	B7	Dp1
A7	Dn1	B6	Dn1
A8	SBU1	B5	SBU1
A9	VBUS	B4	VBUS
A10	SSTXn2	B3	SSTXn2
A11	SSTXp2	B2	SSTXp2
A12	GND	B1	GND

## Standard timing table

MODE			
MODE	Resolution		
1	VGA	640x480	60Hz
2	SVGA	800x600	60Hz
3	XGA	1024x768	60Hz
4	SXGA	1280x1024	60Hz
5	VESA	1280x720	60Hz
6	WXGA	1280x800	60Hz
7	WXGA+	1680x1050	60Hz
8	UXGA	1920x1080	60Hz
9	UXGA*	2560x1440	60Hz
10	UltraWide QHD	3840x1600	60Hz
11	UltraWide QHD	3840x1600	100Hz
12	UltraWide QHD	3840x1600	144Hz
13	UltraWide QHD	3840x1600	185Hz

**Note:**

Item 1, 2, 3, 10 is standard timing table.

Item 4, 5, 6, 7, 8, 9 is PC graphic card generate timing.

Item 11 is HDMI/DP timing only.

Item 12, 13 is DP timing only.

Item 13 is over clock timing.

# Using the Shortcut Menu

## Note:

The following content is for general reference only. Actual product specifications may vary.

The OSD (on screen display) can be used to adjust the settings of your LCD monitor. Press the key to open the OSD. You can use the OSD to adjust the picture quality, OSD position and general settings. For advanced settings, please refer to following page:

## Main page

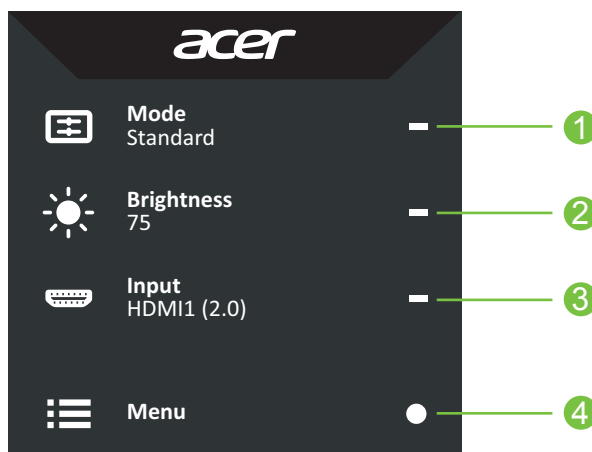

1. Hot Key1  
Modes, Volume, Gamma, Contrast, Blue Light, Over Drive, VRB, PIP/PBP
2. Hot Key2  
Modes, Volume, Gamma, Contrast, Blue Light, Over Drive, VRB, PIP/PBP
3. Hot Key3  
Input Switch Hot Key
4. Main Menu

## Hot key1 (default: Modes)

To choose scenario mode (Action, Racing, Sports) which user-defined profile to use or scenario mode (User, Standard, ECO, Graphics, HDR).

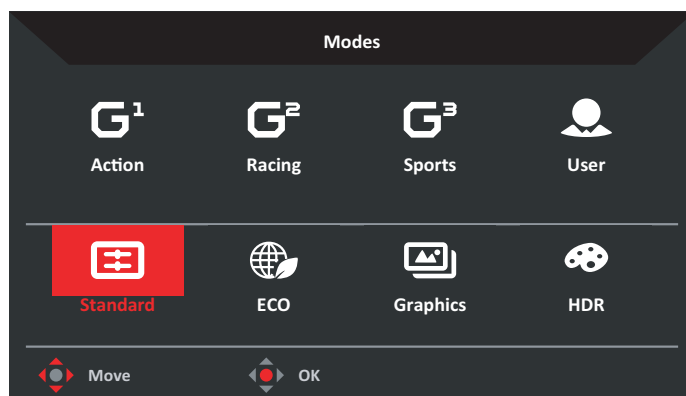

## Hot key2 (default: Brightness)

Open the Brightness control and select your preferred brightness setting. When you are done, press the joystick to quit current page and store.

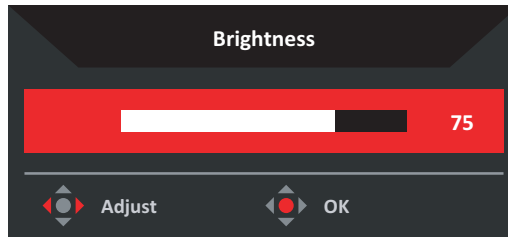





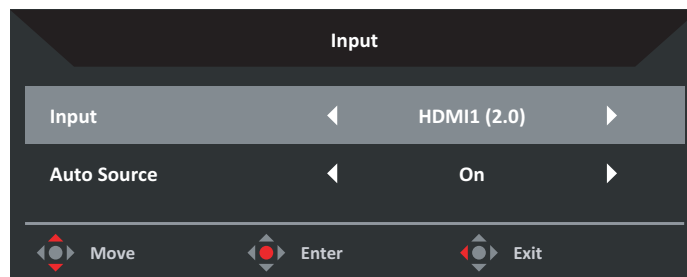



## Hot key3 (Selecting the input)

Open the Input control and select HDMI1 (2.0), HDMI2 (2.0), DP1, DP2 and TYPE C or turn On Auto Source. When you are done, press the joystick to exit current page and store.



## Main Menu

- » Press the **MENU** key to open the OSD.
- » Toggle the joystick  to the up  or down  to select Picture from the OSD. Then toggle to the right to navigate to the element you wish to adjust and press the joystick to enter it.
- » Toggle the joystick  to the left  or right  to adjust the sliding scales.
- » Information Hot Key  - : Show Monitor Information and Reset control function.
- » Modes Hot Key  - : To change Modes Hot Key menu.
- » Exit Hot Key  - to exit current page and store.

## Picture

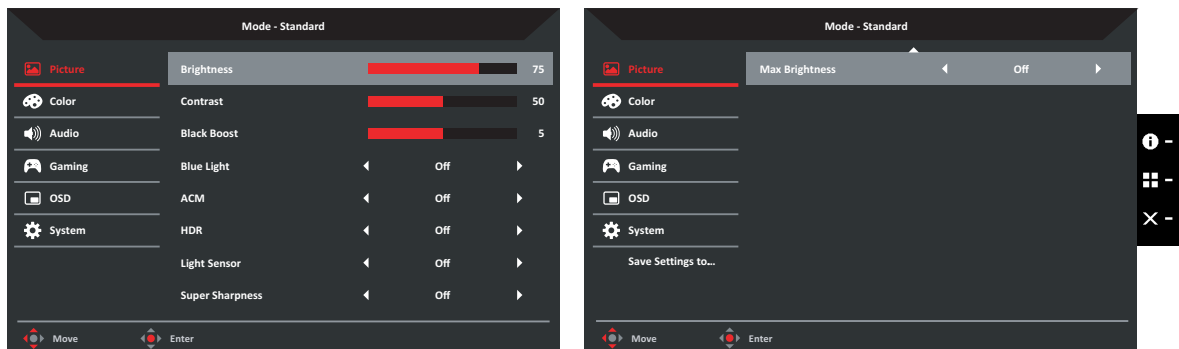

- **Brightness:** Adjust the brightness from **0** to **100**.  
*Note:* Adjusts the balance between light and dark shades.
- **Contrast:** Adjust the contrast from **0** to **100**.  
*Note:* Sets the degree of difference between light and dark areas.
- **Black Boost:** Adjust the Black Boost from **0** to **10**. Enhances shadows by increasing the brightness without changing lighter shades.  
*Note:* If the image is very bright or has few shadow areas, adjusting this setting may not result in any noticeable changes to the image.
- **Blue Light:** Filters out blue light to protect your eyes by adjusting how much blue light is shown – **Off**, **80%**, **70%**, **60%**, or **50%**.  
*Note:*
  - Higher values allow more blue light through. For the best protection select a lower value.
  - When Blue Light function is set to **On**, Brightness and Contrast will show each level of Blue Light value.
- **Adaptive Contrast Management (ACM):** Dynamically adjust the contrast ratio of the input image to achieve ultra-sharp images. Every scene is analyzed to adjust images frame by frame and enhance colour quality, achieving the whitest whites and the deepest blacks. Acer Adaptive Contrast Management allows your LCD monitor to use less power and save energy. Turn this function **On** or **Off**.
- **High Dynamic Range (HDR):** Reproduce a greater dynamic range of luminosity while preserving details in the darkest and brightest areas. Select from **Off** (function is disabled), **Auto** (HDR function is automatically applied to improve the screen image) or **HDR-400**.  
*Note:* If you set the HDR function to **Auto** or **HDR-400**:
  - The Mode and Color Space are automatically set to **HDR**.
  - Contrast, Black Boost, Blue Light, ACM Light Sensor, Gray Scale Mode, 6-axis Hue, 6-axis Saturate, DP Format, and PIP/PBP functions will be grayed out.
- **Light Sensor:** Detect ambient light conditions and dynamically optimize image brightness and color parameters accordingly. Select from **Off** (function is disabled), **Level 1** (brightness will be automatically adjusted to the minimum range), **Level 2** (brightness will be automatically adjusted to the moderate range) or **Level 3** (brightness will be automatically adjusted to the maximum range).
- **Super Sharpness:** Super Sharpness technology can simulate high-resolution images by boosting the pixel density of the original source to make images sharper and clearer. Turn this function **On** or **Off**.

- **Max Brightness:** Default is off.



**Note:** Due to environmental considerations, the default brightness of the display will be low. It can be adjusted to your preferences with the following steps:

Step 1: Go to OSD menu > Picture > Max Brightness, and turn Off to On to increase the brightness.

Step 2: Once Max Brightness is turned On, adjust Brightness value between 0-100 to your preference.

## Color

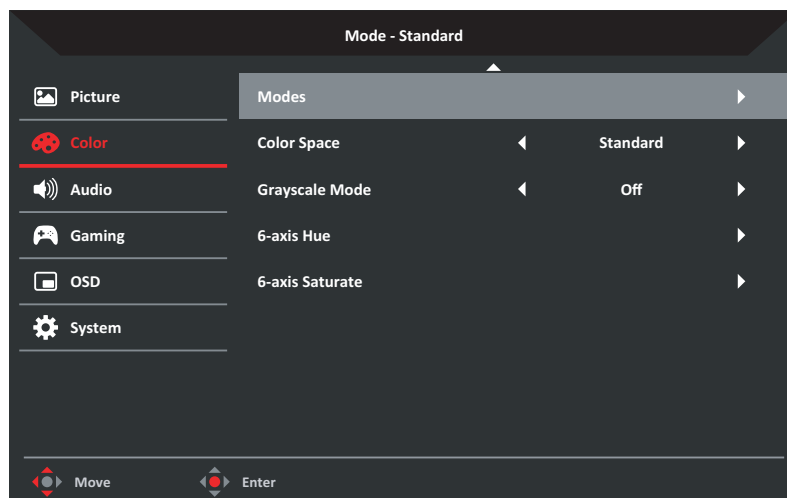
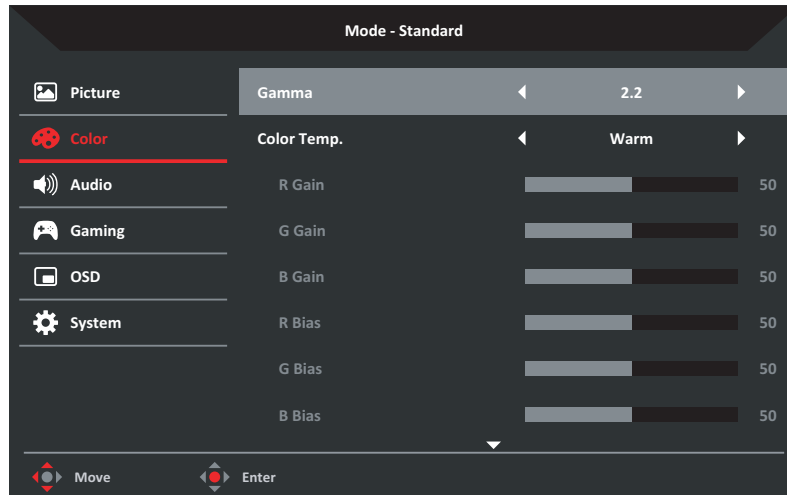

- **Gamma:** Adjust the luminance tone. Select from **1.8, 2.0, 2.2, 2.4** or **2.6**.

**Note:** Gamma value **2.2** is the standard value for Windows operating environment.

- **Color Temp.:** Select the screen image color temperature from:
  - **Warm:** Increases the color temperature and makes the screen image appear warmer with a red and yellow tint.
  - **Normal:** Loads the monitor's normal color settings.
  - **Cool:** Decreases the color temperature and makes the screen image to appear cooler with a blue tint.
  - **Blue Light:** Decreases the level of blue light emitted from the screen to make the screen image more comfortable to view for your eyes.

- **User:** Enables you to adjust the hue and saturation of each color (red (**R**), green (**G**) and blue (**B**)) manually.
- **Modes:** Open Modes Hot Key 1 menu.

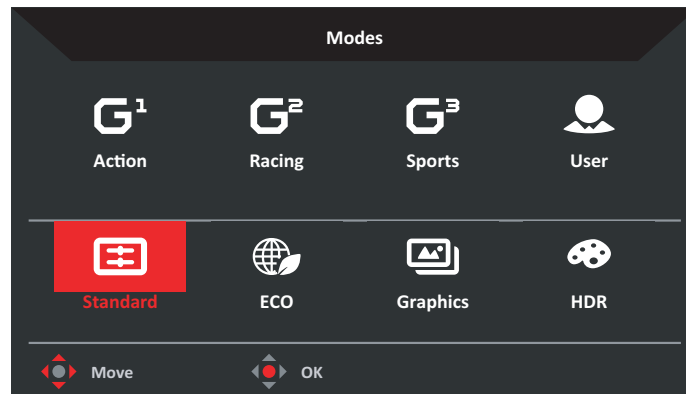

Select the desired mode from:

- **Action:** For better color matching representation with the action game or movie, users can modify some parameters and save them by themselves.
- **Racing:** For better color matching representation with the racing game or movie, users can modify some parameters and save them by themselves.
- **Sports:** For better color matching representation with the sports game or movie, users can modify some parameters and save them by themselves.
- **User:** Applies a combination of picture settings defined by users.
- **Standard:** For basic PC application.
- **ECO:** For saving electricity with low power consumption by providing minimum brightness for all running programs.
- **Graphics:** For better color matching representation with the graphics.
- **HDR:** For better color matching representation with the high dynamic lighting rendering (HDR). For more information on HDR features, refer to page 12.
- **Color Space:** Select your desired color space from **Standard**, **sRGB**, **Rec.709**, **HDR**, **EBU**, **DCI** and **SMPTE-C**.  
**Note:** If the Mode is set to **HDR**, the Color Space is automatically set to **HDR**. In other modes, the Color Space is set to **Standard** by default.
- **Grayscale Mode:** Select **On** to switch to grayscale mode or **Off** to disable this function.
- **6-axis Hue:** Adjust the red, green, blue, yellow, magenta and cyan hue. Select **Reset** to reset all 6-axis hue values to their factory defaults.
- **6-axis Saturate:** Adjust the red, green, blue, yellow, magenta and cyan saturation. Select **Reset** to reset all 6-axis saturation values to their factory defaults.



## Audio

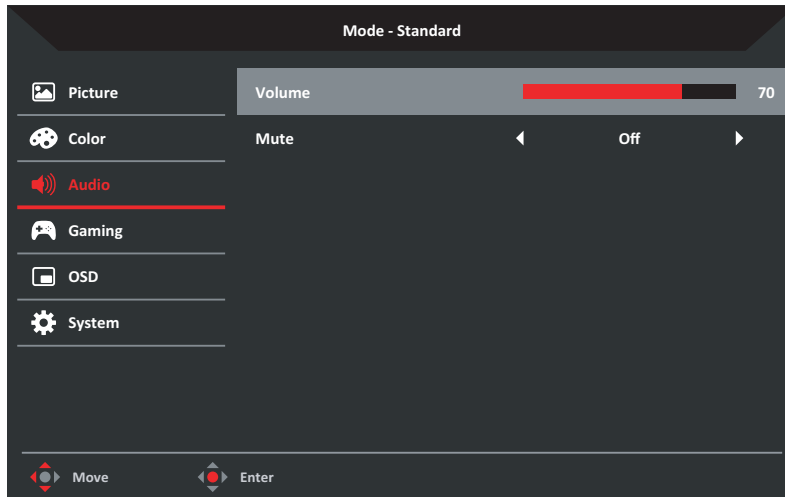

- **Volume:** Adjust the volume level from **0** (audio muted) to **100**.
- **Mute:** Select **On** to mute audio or **Off** to unmute.

## Gaming

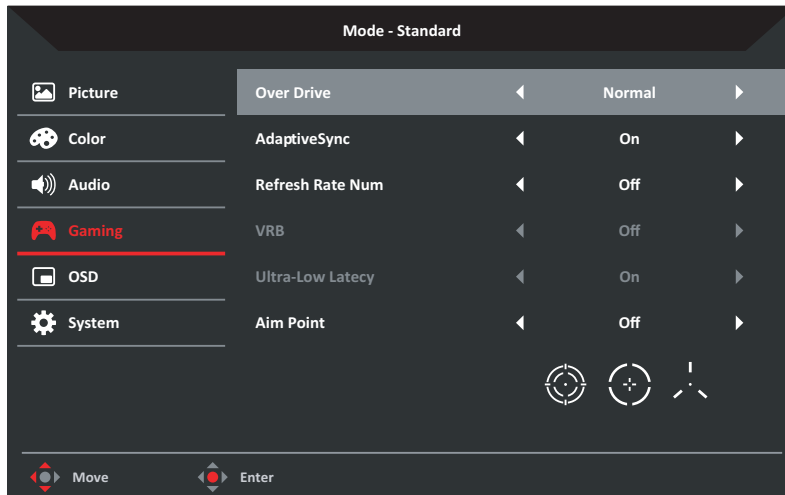

- **Over Driver:** Boost the screen response time. Select from **Off**, **Normal** or **Extreme**.
  - **AdaptiveSync:** To control support. AdaptiveSync or not, default is **On**.
  - **Refresh Rate Num:** Select **On** to display the monitor's current refresh rate on the screen or **Off** to disable the function.
  - **Visual Response Boost (VRB):** Visual Response Boost™ technology makes gameplay seamless and practically blur-free. Select **On** to enable this function or **Off** to disable.
  - **Ultra-Low Latency:** Select **On** to speed up the processing time of the display switching process or **Off** to disable this function.
  - **Aim Point:** Display and Aim point on the screen for shooting games. Select your desired aim point from **Icon1** (🎯), **Icon2** (🎯) or **Icon3** (🎯). Select **Off** to disable this function.
- Note:** Selected aim point is not displayed if PIP/PBP Mode function is enabled.

## OSD

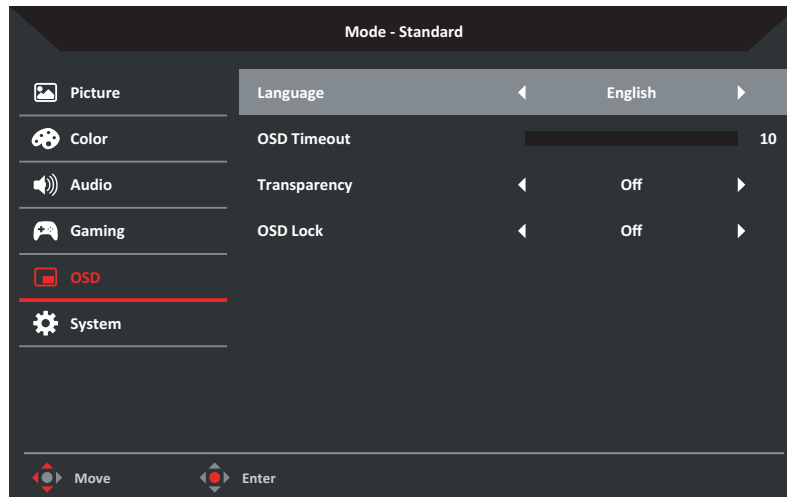

- **Language:** Select the OSD language from **English, Russian, German, French, Spanish, Italian, Dutch, Finnish, Turkish, Polish, Portuguese, Brazilian Portuguese, Traditional Chinese, Simplified Chinese, Japanese** or **Korean**.
- **OSD Timeout:** Adjust the delay before turning off the OSD menu from **10** to **120** ms.
- **Transparency:** Select the transparency when using gaming mode from **Off, 20%, 40%, 60%** or **80%**.
- **OSD Lock:** Select **On** to prevent unwanted access to the OSD menu or **Off** to disable this function.

**Note:** If you set OSD Lock to **On**, a notification appears on the screen informing the OSD is locked (“OSD Locked”). During lock-state, you cannot use any User Control keys. To unlock the OSD, press and hold the joystick for about 5 seconds until the “OSD Unlock” message is displayed on the screen.

## System

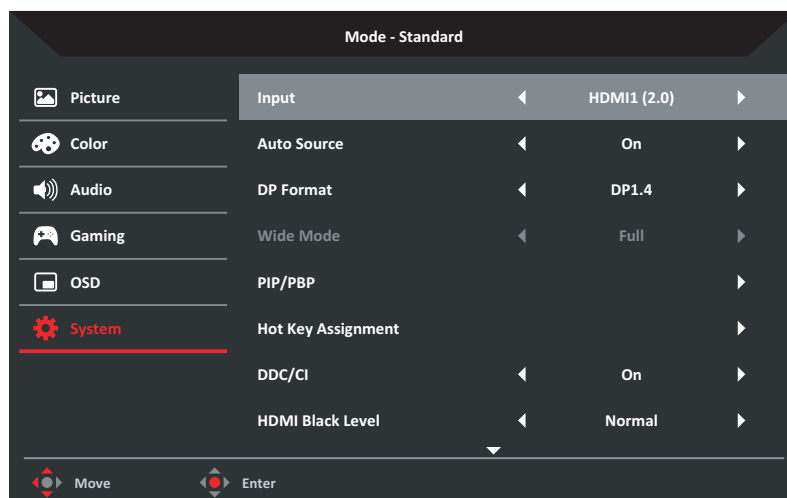

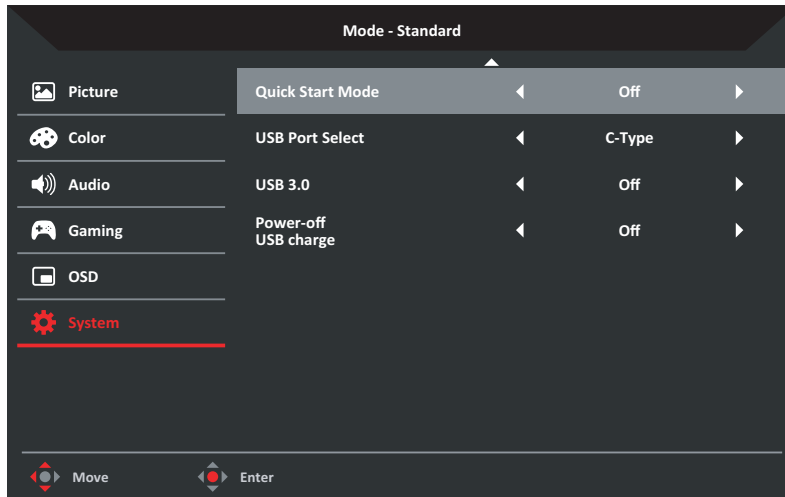

- **Input:** Select the source from HDMI1 (2.0), DHMI2 (2.0), DP1, DP2 or TYPE C.
- **Auto Source:** Select **On** to enable auto search for signal source in order or **Off** to disable this function.
- **DisplayPort (DP) Format:** Select the DisplayPort format from **DP1.1**, **DP1.2** or **DP1.4**.





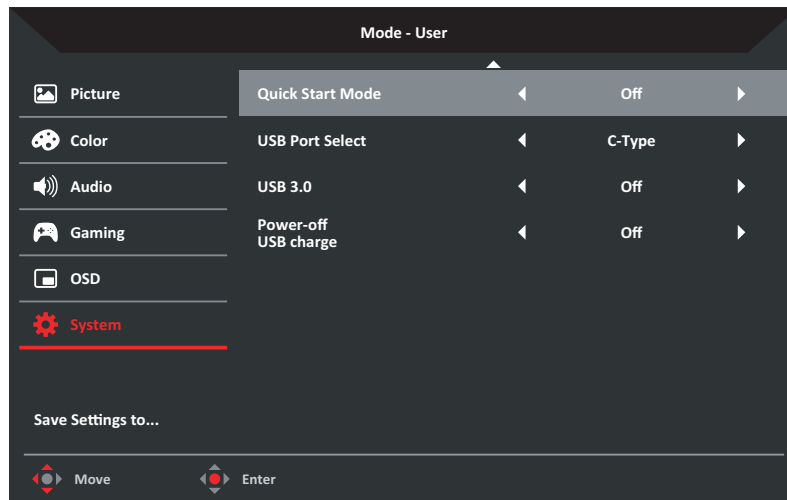

**Note:**

- The default displayport format DP1.4 can support high-bandwidth video.
- DP1.1 and DP1.2 support most video formats.
- If the Mode is set to **HDR**, the default DP Format will be **DP1.4** and other DP formats will be grayed out.
- **Wide Mode:** Select your preferred screen aspect from **Full**, **Aspect** or **1:1**.
- **PIP/PBP > PIP/PBP Mode:** Select PIP/PBP Mode from Off (function is disabled) or from any of the following:
  - **PIP Large/PIP Small:** Displays the sub source in a large window or small window respectively. After you select this option, select the PIP Position from **Top Left**, **Top Right**, **Bottom Right** or **Bottom Left** and Sub Source from **HDMI1 (2.0)**, **HDMI2 (2.0)**, **DP1**, **DP2** or **TYPE C**. Then select Source Swap to swap the main source and sub source. Finally select Audio Source from **Main** (source) or **Sub** (source).
  - **PBP:** Displays the main source and sub source next to each other. Select the PBP Size from **Aspect** and **Full**, select Sub Source from **HDMI1 (2.0)**, **HDMI2 (2.0)**, **DP1**, **DP2** or **TYPE C**. Then select Source Swap to swap the main source and sub source. Finally select Audio Source from **Main** (source) or **Sub** (source).
- **Hot Key Assignment:** Select the function of Hot Key 1 and Hot Key 2 from **Modes**, **Volume**, **Gamma**, **Contrast**, **Blue Light**, **Over Drive**, **VRB** or **PIP/PBP**.
- **Display Data Channel (DDC)/Command Interface (CI):** Configure monitor settings remotely from PC that is connected to the monitor. Select **On** to enable this function or **Off** to disable.
- **HDMI Black Level:** Select the HDMI Black Level from **Normal** or **Low**.
- **Quick Start Mode:** Select **On** to speed up boot speed or **Off** to disable the function.
- **USB Port Select:** Set the USB port type to **C-Type** or **B-Type**.
- **USB 3.0:** Select **On** to enable USB 3.0 or **Off** to disable the function.

- **Power-off USB charge:** Select **On** to provide charging functionality to other devices via USB type-C port even when the monitor is turned off or **Off** to disable this function.

## Save Settings to... (User mode only)



1. Press the **MENU** key to open the OSD.
2. Toggle the joystick  to the up  or down  to select **Save Setting to...** from the OSD.
3. Toggle the joystick to the right to access the menu items.
4. Toggle the joystick  to the up  or down  to select your preferred game mode (**Game Mode: Action**, **Game Mode: Racing** or **Game Mode: Sports**) where you want to save settings to.
5. Press the joystick on your preferred game mode to save the settings.

# Troubleshooting

Before sending your LCD monitor for servicing, please check the troubleshooting list below to see if you can self-diagnose the problem.

## HDMI/DP Mode (Optional)

Problem	LED status	Remedy
No picture visible	Blue	Using the OSD menu, adjust brightness and contrast to maximum or reset to their default setting.
	Off	<ul style="list-style-type: none"> <li>- Check the power switch.</li> <li>- Check if the AC power cord is properly connected to the monitor.</li> </ul>
	Amber	<ul style="list-style-type: none"> <li>- Check if the video signal cable is properly connected at the back of the monitor.</li> <li>- Check if the computer system is switched on and in power saving/standby mode.</li> </ul>

### Note:

Acer monitor is purposed for video and visual display of information obtained from electronic devices.

X34 GS



Product Information for EU Energy

