



# Alienware AW2721D Monitor User's Guide

Model: AW2721D  
Regulatory model: AW2721Db

A L I E N W A R E™ 

# Notes, cautions, and warnings

-  **NOTE:** A NOTE indicates important information that helps you make better use of your computer.
-  **CAUTION:** A CAUTION indicates potential damage to hardware or loss of data if instructions are not followed.
-  **WARNING:** A WARNING indicates a potential for property damage, personal injury, or death.

© 2020-2021 Dell Inc. or its subsidiaries. All rights reserved. Dell, EMC, and other trademarks are trademarks of Dell Inc. or its subsidiaries. Other trademarks may be trademarks of their respective owners.

2021 - 03

Rev. A02

# Contents

<b>Safety instructions</b> .....	<b>6</b>
<b>About your monitor</b> .....	<b>7</b>
<b>Package contents</b> .....	<b>7</b>
<b>Product features</b> .....	<b>9</b>
<b>Identifying parts and controls</b> .....	<b>10</b>
<b>Front view</b> .....	<b>10</b>
<b>Top view</b> .....	<b>11</b>
<b>Back view</b> .....	<b>11</b>
<b>Rear and bottom view</b> .....	<b>13</b>
<b>Monitor specifications</b> .....	<b>16</b>
<b>Resolution specifications</b> .....	<b>17</b>
<b>Supported video modes</b> .....	<b>18</b>
<b>Preset display modes</b> .....	<b>18</b>
<b>Electrical specifications</b> .....	<b>20</b>
<b>Physical characteristics</b> .....	<b>21</b>
<b>Environmental characteristics</b> .....	<b>22</b>
<b>Pin assignments</b> .....	<b>23</b>
<b>Plug and Play capability</b> .....	<b>24</b>
<b>Universal Serial Bus (USB) interface</b> .....	<b>25</b>
<b>USB 3.2 Gen1 (5 Gbps) upstream connector</b> .....	<b>25</b>
<b>USB 3.2 Gen1 (5 Gbps) downstream connector</b> .....	<b>26</b>
<b>USB ports</b> .....	<b>26</b>
<b>LCD monitor quality and pixel policy</b> .....	<b>27</b>
<b>Ergonomics</b> .....	<b>27</b>
<b>Handling and moving your display</b> .....	<b>29</b>
<b>Maintenance guidelines</b> .....	<b>30</b>
<b>Cleaning your monitor</b> .....	<b>30</b>

<b>Setting up the monitor</b> . . . . .	<b>31</b>
Attaching the stand . . . . .	31
Connecting the computer . . . . .	35
Removing the monitor stand . . . . .	36
VESA wall mounting (optional) . . . . .	38
<b>Operating the monitor</b> . . . . .	<b>39</b>
Power on the monitor . . . . .	39
Using the joystick control . . . . .	39
Using the rear-panel controls . . . . .	40
Using the On-Screen Display (OSD) menu . . . . .	41
Accessing the menu system . . . . .	41
OSD warning message . . . . .	53
Setting the maximum resolution . . . . .	54
Using the tilt, swivel, and vertical extension . . . . .	55
Tilt and swivel extensions . . . . .	55
Vertical extension . . . . .	55
Rotating the display . . . . .	56
Rotate clockwise . . . . .	56
Rotate counterclockwise . . . . .	57
Adjusting the rotation display settings of your system . . . . .	58
<b>Using AlienFX application</b> . . . . .	<b>59</b>
Prerequisites . . . . .	59
Installing AWCC through Windows update . . . . .	59
Installing AWCC from the Dell Support website . . . . .	59
Navigating the AlienFX window . . . . .	60
Creating a theme . . . . .	62
Setting lighting effects . . . . .	63
<b>Troubleshooting</b> . . . . .	<b>66</b>
Self-test . . . . .	66



**Built-in diagnostics . . . . .67**  
**Common problems . . . . .68**  
**Product specific problems . . . . .71**  
**Universal Serial Bus (USB) specific problems. . . . .73**  
**Appendix . . . . .74**  
**FCC notices (U.S. only) and other regulatory information. . . . .74**  
**Contact Dell. . . . .74**  
**EU product database for energy label and product information sheet . . . . .74**

# Safety instructions

**△ CAUTION: Use of controls, adjustments, or procedures other than those specified in this documentation may result in exposure to shock, electrical hazards, and/or mechanical hazards.**





- Place the monitor on a solid surface and handle it carefully. The screen is fragile and can be damaged if dropped or hit sharply.
- Always be sure that your monitor is electrically rated to operate with the AC power available in your location.
- Keep the monitor in room temperature. Excessive cold or hot conditions can have an adverse effect on the liquid crystal of the display.
- Do not subject the monitor to severe vibration or high impact conditions. For example, do not place the monitor inside a car trunk.
- Unplug the monitor when it is going to be left unused for an extended period of time.
- To avoid electric shock, do not attempt to remove any cover or touch the inside of the monitor.



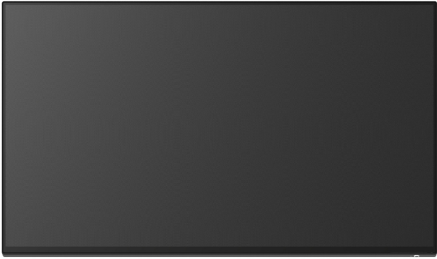

# About your monitor

## Package contents

Your monitor ships with the components shown below. If any component is missing, contact Dell technical support. For more information see [Contact Dell](#).

 **NOTE: Some components may be optional and may not ship with your monitor. Some features or media may not be available in certain countries.**

Component image	Component description
	Display
	Stand riser
	Stand base
	I/O cover

	<p>Power cable (varies by country)</p>
	<p>DisplayPort to DisplayPort cable (1.8 meters)</p>
	<p>Mini-DisplayPort to DisplayPort cable (1.8 meters)</p>
	<p>USB 3.2 Gen1 (5 Gbps) upstream cable (enables the USB ports on the monitor, 1.8 meters)</p>
	<ul style="list-style-type: none"> <li>▪ Quick Setup Guide</li> <li>▪ Safety, Environmental, and Regulatory Information</li> <li>▪ Alienware Welcome Card</li> </ul>

## Product features

The **Alienware AW2721D** monitor has an active matrix, Thin-Film Transistor (TFT), Liquid Crystal Display (LCD) and LED backlight. The monitor features include:

- 68.47 cm (27 inch) viewable area (measured diagonally). Resolution: Up to 2560 x 1440 through DisplayPort and HDMI, with full-screen support or lower resolutions, supporting a high refresh rate of 240 Hz.
- NVIDIA® G-SYNC® ULTIMATE monitor with a rapid response time of 1 ms gray to gray in **Extreme** mode\*.
- Color gamut of 131.3% sRGB and DCI P3 98%.
- Tilt, swivel, pivot, and height adjustment capabilities.
- Removable stand and Video Electronics Standards Association (VESA™) 100 mm mounting holes for flexible mounting solutions.
- Digital connectivity via 1 DisplayPort and 2 HDMI ports.
- Equipped with 1 SuperSpeed USB 5 Gbps (USB 3.2 Gen1) Type B upstream port, 1 SuperSpeed USB 5 Gbps (USB 3.2 Gen1) Type-A downstream charging port, and 3 SuperSpeed USB 5 Gbps (USB 3.2 Gen1) Type-A downstream ports.
- Plug and play capability if supported by your system.
- On-Screen Display (OSD) adjustments for ease of setup and screen optimization.
- AW2721D offers a couple of preset modes, including FPS (First-Person Shooter), MOBA/RTS (Real-Time Strategy), RPG (Role-Playing Game), SPORTS (Racing) and three customizable game modes for user's own preference. In addition, key enhanced gaming features such as Timer, Frame Rate, and Display Alignment are provided to help improve gamer's performance and provide best-in game advantage.
- $\leq 0.3$  W in Standby Mode.
- VESA DisplayHDR™ 600.
- Optimize eye comfort with a flicker-free screen.

**⚠ WARNING: The possible long-term effects of blue light emission from the monitor may cause damage to the eyes, including eye fatigue, digital eye strain, and so on. ComfortView feature is designed to reduce the amount of blue light emitted from the monitor to optimize eye comfort.**

\*The 1 ms gray-to-gray mode is achievable in the **Extreme** mode to reduce visible motion blur and increased image responsiveness. However, this may introduce some slight and noticeable visual artifacts into the image. As every system setup and every gamer's needs are different, Alienware recommends that

users experiment with the different modes to find the setting that is right for them.

## Identifying parts and controls

### Front view

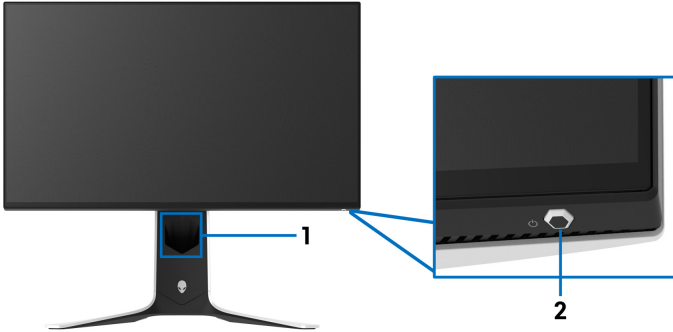

Label	Description	Use
1	Cable-management slot (on the front side of the stand)	To organize the cables neatly.
2	Power On/Off button (with LED indicator)	To turn the monitor on or off. Solid blue light indicates that the monitor is turned on and functioning normally. Blinking white light indicates that the monitor is in Standby Mode.

### Top view

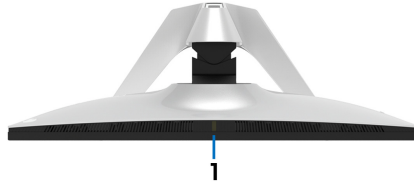

Label	Description	Use
1	Ambient light sensor	Detects ambient light and adjusts the brightness of the display accordingly. For more information, see <a href="#">Ambient Light Sensor</a> .

### Back view

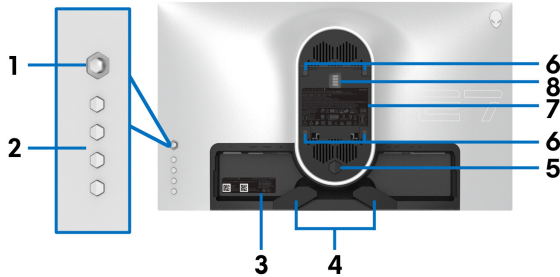

### Back view without monitor stand

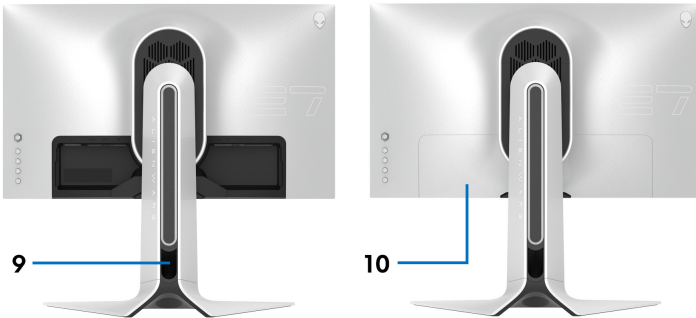

### Back view with monitor stand

<b>Label</b>	<b>Description</b>	<b>Use</b>
<b>1</b>	Joystick	Use it to control the OSD menu.
<b>2</b>	Function buttons	For more information, see <a href="#">Operating the monitor</a> .
<b>3</b>	Barcode, serial number, and Service Tag label	Refer to this label if you need to contact Dell for technical support. The Service Tag is a unique alphanumeric identifier that enables Dell service technicians to identify the hardware components in your monitor and access warranty information.
<b>4</b>	Cable-management clips (2)	To organize the cables neatly.
<b>5</b>	Stand release button	Releases the stand from the monitor.
<b>6</b>	VESA mounting holes (100 mm x 100 mm - behind VESA Cover)	Wall mount monitor using VESA-compatible wall mount kit (100 mm x 100 mm).
<b>7</b>	Regulatory label	Lists the regulatory approvals.
<b>8</b>	Lighting dock connector	When the stand riser is attached to the monitor, the dock supplies power to the light on the stand.
<b>9</b>	Cable-management slot (at the back of the stand)	To organize cables by routing them through this slot.
<b>10</b>	I/O cover	Protects the I/O ports.



## Rear and bottom view

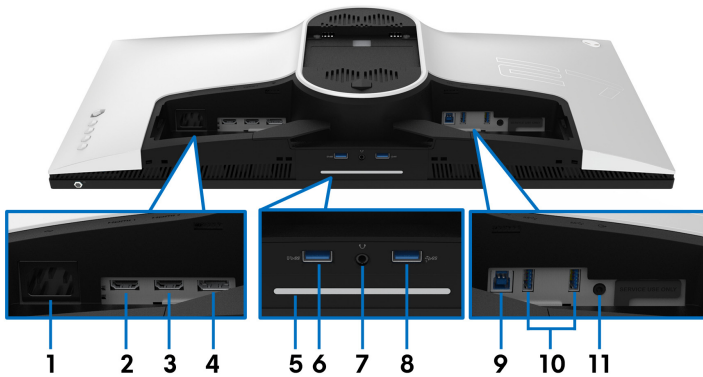

**Rear and bottom view without monitor stand**

Label	Description	Use
1	Power connector	Connect the power cable (shipped with your monitor).
2	HDMI port (HDMI 1)	Connect your computer with the HDMI cable.
3	HDMI port (HDMI 2)	Connect your computer with the HDMI cable.
4	DisplayPort	<ul style="list-style-type: none"><li>Connect your computer with DisplayPort-DisplayPort cable (shipped with your monitor)</li></ul> or <ul style="list-style-type: none"><li>Connect your computer with mini-DisplayPort-DisplayPort cable (shipped with your monitor)</li></ul>

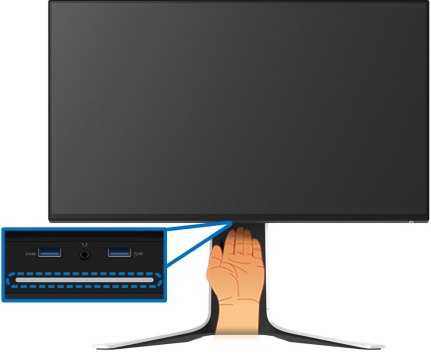
<p><b>5</b></p>	<p>Downlights</p>	<p>When the monitor set up is complete, tap the touch sensor at the bottom of the display to turn the downlights on or off.</p> 														
<p><b>NOTE:</b> The factory setting is on, so the downlights are active if the power cable is connected. To change the default settings, see <a href="#">AlienFX Lighting</a>.</p> <p><b>NOTE:</b> When the <b>Spectrum</b> function is <b>On</b>, the downlights are turned off.</p> <table border="1" data-bbox="219 831 977 1117"> <thead> <tr> <th rowspan="2">Monitor State</th> <th colspan="2">Downlights Status</th> </tr> <tr> <th>When <b>Spectrum</b> is Off</th> <th>When <b>Spectrum</b> is On</th> </tr> </thead> <tbody> <tr> <td>On</td> <td>Enabled</td> <td>Disabled</td> </tr> <tr> <td>No Signal</td> <td>Enabled</td> <td>Disabled</td> </tr> <tr> <td>Standby</td> <td>Enabled</td> <td>Disabled</td> </tr> </tbody> </table>			Monitor State	Downlights Status		When <b>Spectrum</b> is Off	When <b>Spectrum</b> is On	On	Enabled	Disabled	No Signal	Enabled	Disabled	Standby	Enabled	Disabled
Monitor State	Downlights Status															
	When <b>Spectrum</b> is Off	When <b>Spectrum</b> is On														
On	Enabled	Disabled														
No Signal	Enabled	Disabled														
Standby	Enabled	Disabled														
<p><b>6</b></p>	<p>SuperSpeed USB 5 Gbps (USB 3.2 Gen1) Type-A downstream port with Power Charging</p>	<p>Connect to charge your USB device.</p>														

7	Headphone port	<p>Connect the headphone or speakers.</p> <p><b>CAUTION: Increasing the audio output beyond 50% on the volume control or equalizer may increase the output voltage on the headphones thereby increasing the sound pressure levels.</b></p>
8, 10	SuperSpeed USB 5 Gbps (USB 3.2 Gen1) Type-A downstream port (3)	<p>Connect your USB 3.2 Gen1 (5 Gbps) device.*</p> <p><b>NOTE:</b> To use these ports, you must connect the USB cable (shipped with your monitor) to the USB-upstream port on the monitor and to your computer.</p>
9	SuperSpeed USB 5 Gbps (USB 3.2 Gen1) Type-B upstream port	<p>Connect the USB cable (shipped with your monitor) to this port and your computer to enable the USB ports on your monitor.</p>
11	Line-out port	<p>Connect your speakers.</p> <p><b>NOTE:</b> This port does not support headphones.</p>

\*To avoid signal interference, when a wireless USB device has been connected to a USB downstream port, it is not recommended to connect any other USB devices to the adjacent port.

## Monitor specifications

Model	AW2721D
Screen type	Active matrix - TFT LCD
Panel technology	IPS
Aspect ratio	16:9
Viewable image	
Diagonal	684.7 mm (27.0 in.)
Width (active area)	596.7 mm (23.49 in.)
Height (active area)	335.7 mm (13.21 in.)
Total area	200301.7 mm <sup>2</sup> (310.30 in <sup>2</sup> )
Pixel pitch	0.2331 mm x 0.2331 mm
Pixel per inch (PPI)	109
Viewing angle	
Vertical	178° (typical)
Horizontal	178° (typical)
Luminance output	
	450 cd/m <sup>2</sup> (typical) 600 cd/m <sup>2</sup> (HDR peak)
Contrast ratio	1000 to 1 (typical)
Faceplate coating	Anti-glare with 3H hardness
Backlight	LED edgelight system
Response time	<ul style="list-style-type: none"> <li>▪ 1 ms gray to gray in <b>Extreme Mode</b>*</li> <li>▪ 2 ms gray to gray in <b>Super Fast Mode</b></li> <li>▪ 3 ms gray to gray in <b>Fast Mode</b></li> </ul> <p>*The 1 ms gray-to-gray mode is achievable in the <b>Extreme</b> mode to reduce visible motion blur and increased image responsiveness. However this may introduce some slight and noticeable visual artifacts into the image. As every system setup and every gamer's needs are different, Alienware recommends that users experiment with the different modes to find the setting that is right for them.</p>
Color depth	1.07 billion colors
Color gamut	131.3% sRGB and DCI P3 98%

Built-in devices	<ul style="list-style-type: none"> <li>▪ SuperSpeed USB 5Gbps (USB 3.2 Gen1) hub (with 1 USB 3.2 Gen1 (5 Gbps) upstream port)</li> <li>▪ 4 x USB 5Gbps (USB 3.2 Gen1) downstream port (including 1 port which supports power-charging)</li> </ul>
Connectivity	<ul style="list-style-type: none"> <li>▪ 1 x DisplayPort version 1.4 (rear)</li> <li>▪ 2 x HDMI port version 2.0 (rear)</li> <li>▪ 1 x USB 3.2 Gen1 (5 Gbps) upstream port (rear)</li> <li>▪ 4 x USB 3.2 Gen1 (5 Gbps) downstream ports (bottom: 2; rear: 2)</li> <li>▪ 1 x headphone port (bottom)</li> <li>▪ 1 x audio line-out port (rear)</li> </ul>
Border width (edge of monitor to active area)	
Top	5.5 mm
Left/Right	5.5 mm/5.5 mm
Bottom	14.9 mm
Adjustability	
Height adjustable stand	0 mm to 130 mm
Tilt	-5° to 21°
Swivel	-20° to 20°
Pivot	-90° to 90°

## Resolution specifications

Model	AW2721D
Horizontal scan range	<ul style="list-style-type: none"> <li>▪ DisplayPort 1.4: 255 to 255 kHz (automatic)</li> <li>▪ HDMI 2.0: 30 to 222 kHz (automatic)</li> </ul>
Vertical scan range	<ul style="list-style-type: none"> <li>▪ DisplayPort 1.4: 1 to 240 Hz (automatic)</li> <li>▪ HDMI 2.0: 24 to 144 Hz (automatic)</li> </ul>
Maximum preset resolution	<ul style="list-style-type: none"> <li>▪ DisplayPort: 2560 x 1440 @ 240 Hz</li> <li>▪ HDMI: 2560 x 1440 @ 144 Hz</li> </ul>

## Supported video modes

<b>Model</b>	<b>AW2721D</b>
Video display capabilities (HDMI & DisplayPort playback)	480p, 576p, 720p, 1080p, QHD

## Preset display modes

### HDMI display modes

<b>Display mode</b>	<b>Horizontal frequency (kHz)</b>	<b>Vertical frequency (Hz)</b>	<b>Pixel clock (MHz)</b>	<b>Sync polarity (Horizontal/Vertical)</b>
VESA, 640 x 480	31.47	60	25.175	-/-
VESA, 800 x 600	37.88	60	40	+/+
VESA, 1024 x 768	48.36	60	65	-/-
640 x 480p	31.48	60	25.18	-/-
720 x 480p	31.5	60	27.03	-/-
720 x 576p	31.25	50	27	-/-
1280 x 720p @ 50 Hz	37.5	50	74.25	+/+
1280 x 720p @ 60 Hz	45	60	74.25	+/+
1920 x 1080p @ 24 Hz	27	24	74.25	+/+
1920 x 1080p @ 50 Hz	56.25	50	148.5	+/+
1920 x 1080p @ 60 Hz	67.5	60	148.5	+/+
1920 x 1080p @ 120 Hz	135	120	297	+/+
2560 x 1440 @ 60 Hz	89.43	60	243.25	+/-
2560 x 1440 @ 100 Hz	150.9	100	410.5	+/-
2560 x 1440 @ 120 Hz	183	120	497.75	+/-
2560 x 1440 @ 144 Hz	222.2	144	597.69	+/-

## DP display modes

Display mode	Horizontal frequency (kHz)	Vertical frequency (Hz)	Pixel clock (MHz)	Sync polarity (Horizontal/Vertical)
VESA, 640 x 480	31.47	60	25.175	-/-
VESA, 800 x 600	37.88	60	40	-/-
VESA, 1024 x 768	48.36	60	65	-/-
2560 x 1440 @ 60 Hz	89.43	60	243.25	+/-
2560 x 1440 @ 100 Hz	150.92	100	410.5	+/-
2560 x 1440 @ 120 Hz	183	120	497.75	+/-
2560 x 1440 @ 144 Hz	222.2	144	597.69	+/-
2560 x 1440 @ 200 Hz	317.2	200	862.75	+/-
2560 x 1440 @ 240 Hz	388.5	240	1056.75	+/-

 **NOTE:** This monitor supports NVIDIA® G-SYNC® ULTIMATE. For information about the graphic cards that support NVIDIA® G-SYNC® ULTIMATE feature, see [www.geforce.com](http://www.geforce.com).

 **NOTE:** In order to get the full NVIDIA® G-SYNC® ULTIMATE functionalities and experience, you must ensure that the monitor is directly connected to the HDMI or DisplayPort with direct output from Nvidia Graphics card on your PC.

## Electrical specifications

Model	AW2721D
Video input signals	HDMI 2.0/DisplayPort 1.4, 600 mV for each differential line, 100 $\Omega$ input impedance per differential pair
AC input voltage/frequency/current	100 VAC to 240 VAC / 50 Hz or 60 Hz $\pm$ 3 Hz / 1.8 A (typical)
Inrush current	<ul style="list-style-type: none"><li>▪ 120 V: 40 A (max.) at 0°C (cold start)</li><li>▪ 220 V: 80 A (max.) at 0°C (cold start)</li></ul>
Power consumption	<ul style="list-style-type: none"><li>▪ 0.2 W (Off mode)<sup>1</sup></li><li>▪ 0.3 W (Standby Mode)<sup>1</sup></li><li>▪ 31 W (On mode)<sup>1</sup></li><li>▪ 95 W (Max.)<sup>2</sup></li><li>▪ 22.69 W (Pon)<sup>3</sup></li><li>▪ 72.25 kWh (TEC)<sup>3</sup></li></ul>

<sup>1</sup> As defined in EU 2019/2021 and EU 2019/2013.

<sup>2</sup> Max brightness and contrast setting with maximum power loading on all USB ports.

<sup>3</sup> Pon: Power consumption of On Mode measured with reference to Energy Star test method.

TEC: Total energy consumption in kWh measured with reference to Energy Star test method.

This document is informational only and reflects laboratory performance. Your product may perform differently, depending on the software, components and peripherals you ordered and shall have no obligation to update such information.

Accordingly, the customer should not rely upon this information in making decisions about electrical tolerances or otherwise. No warranty as to accuracy or completeness is expressed or implied.



## Physical characteristics

<b>Model</b>	<b>AW2721D</b>
<b>Signal cable type</b>	<ul style="list-style-type: none"> <li>▪ Digital: HDMI, 19 pins (cable is not included)</li> <li>▪ Digital: DisplayPort, 20 pins</li> <li>▪ Universal Serial Bus: USB, 9 pins</li> </ul>
<p><b>NOTE:</b> Dell monitors are designed to work optimally with the video cables that are shipped with your monitor. As Dell does not have control over the different cable suppliers in the market, the type of material, connector and process used to manufacture these cables, Dell does not guarantee video performance on cables that are not shipped with your Dell monitor.</p>	
<b>Dimensions (with stand)</b>	
Height (extended)	555.3 mm (21.86 in.)
Height (compressed)	443.1 mm (17.45 in.)
Width	607.7 mm (23.93 in.)
Depth	251.9 mm (9.92 in.)
<b>Dimensions (without stand)</b>	
Height	356.0 mm (14.02 in.)
Width	607.7 mm (23.93 in.)
Depth	82.4 mm (3.24 in.)
<b>Stand dimensions</b>	
Height (extended)	451.9 mm (17.79 in.)
Height (compressed)	443.1 mm (17.45 in.)
Width	465.2 mm (18.32 in.)
Depth	251.9 mm (9.92 in.)
<b>Weight</b>	
Weight with packaging	15.5 kg (34.17 lb)
Weight with stand assembly and cables	10.9 kg (24.03 lb)
Weight without stand assembly (For wall mount or VESA mount considerations - no cables)	6.3 kg (13.89 lb)
Weight of stand assembly	4.3 kg (9.48 lb)

## Environmental characteristics

<b>Model</b>	<b>AW2721D</b>
<b>Compliant standards</b>	
Arsenic-free glass and mercury-free for the panel only	
<b>Temperature</b>	
Operating	0°C to 40°C (32°F to 104°F)
Non-operating	<ul style="list-style-type: none"><li>Storage: -20°C to 60°C (-4°F to 140°F)</li><li>Shipping: -20°C to 60°C (-4°F to 140°F)</li></ul>
<b>Humidity</b>	
Operating	10% to 80% (non-condensing)
Non-operating	<ul style="list-style-type: none"><li>Storage: 5% to 90% (non-condensing)</li><li>Shipping: 5% to 90% (non-condensing)</li></ul>
<b>Altitude</b>	
Operating	5,000 m (16,404 ft) (maximum)
Non-operating	12,192 m (40,000 ft) (maximum)
<b>Thermal dissipation</b>	<ul style="list-style-type: none"><li>324.14 BTU/hour (maximum)</li><li>119.42 BTU/hour (typical)</li></ul>

## Pin assignments

### DisplayPort connector

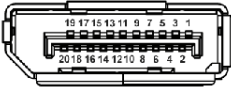

Pin number	20-pin side of the connected signal cable
1	ML3 (n)
2	GND
3	ML3 (p)
4	ML2 (n)
5	GND
6	ML2 (p)
7	ML1 (n)
8	GND
9	ML1 (p)
10	ML0 (n)
11	GND
12	ML0 (p)
13	GND
14	GND
15	AUX (p)
16	GND
17	AUX (n)
18	Hot Plug Detect
19	Re-PWR
20	+3.3 V DP_PWR

## HDMI connector

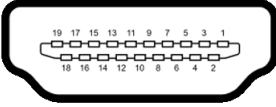

Pin number	19-pin side of the connected signal cable
1	TMDS DATA 2+
2	TMDS DATA 2 SHIELD
3	TMDS DATA 2-
4	TMDS DATA 1+
5	TMDS DATA 1 SHIELD
6	TMDS DATA 1-
7	TMDS DATA 0+
8	TMDS DATA 0 SHIELD
9	TMDS DATA 0-
10	TMDS CLOCK+
11	TMDS CLOCK SHIELD
12	TMDS CLOCK-
13	CEC
14	Reserved (N.C. on device)
15	DDC CLOCK (SCL)
16	DDC DATA (SDA)
17	DDC/CEC Ground
18	+5 V POWER
19	HOT PLUG DETECT

## Plug and Play capability

You can connect the monitor to any Plug and Play-compatible system. The monitor automatically provides the computer system with its Extended Display Identification Data (EDID) using Display Data Channel (DDC) protocols so that the system can configure itself and optimize the monitor settings. Most monitor installations are automatic; you can select different settings if desired. For more information about changing the monitor settings, see [Operating the monitor](#).

## Universal Serial Bus (USB) interface

This section gives you information about the USB ports that are available on the monitor.

 **NOTE: This monitor is SuperSpeed USB 5 Gbps (USB 3.2 Gen1) compatible.**

Transfer speed	Data rate	Power consumption*
Super-Speed	5 Gbps	4.5 W (Max, each port)
High speed	480 Mbps	4.5 W (Max, each port)
Full speed	12 Mbps	4.5 W (Max, each port)

\*Up to 2 A on USB downstream port (with  battery icon) with battery charging version-compliant devices or normal USB devices.

### USB 3.2 Gen1 (5 Gbps) upstream connector

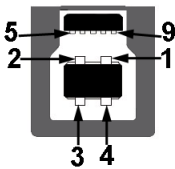

Pin number	9-pin side of the connector
1	VCC
2	D-
3	D+
4	GND
5	SSTX-
6	SSTX+
7	GND
8	SSRX-
9	SSRX+

## USB 3.2 Gen1 (5 Gbps) downstream connector



Pin number	9-pin side of the connector
1	VCC
2	D-
3	D+
4	GND
5	SSRX-
6	SSRX+
7	GND
8	SSTX-
9	SSTX+

### USB ports

- 1 x upstream - rear
- 2 x downstream - rear
- 2 x downstream - bottom

Power charging port - the port with  icon; supports up to 2 A fast-charging capability if the device is BC1.2 compatible.

 **NOTE: SuperSpeed USB 5 Gbps (USB 3.2 Gen1) functionality requires a SuperSpeed USB 5 Gbps (USB 3.2 Gen1)-capable computer.**

 **NOTE: The USB ports on the monitor work only when the monitor is turned on or in Standby mode. If you turn off the monitor and then turn it on, the attached peripherals may take a few seconds to resume normal functionality.**

## LCD monitor quality and pixel policy

During the LCD monitor manufacturing process, it is not uncommon for one or more pixels to become fixed in an unchanging state, which are hard to see and do not affect the display quality or usability. For more information on Dell Monitor Quality and Pixel Policy, see [www.dell.com/pixelguidelines](http://www.dell.com/pixelguidelines).

## Ergonomics

△ **CAUTION: Improper or prolonged usage of keyboard may result in injury.**

△ **CAUTION: Viewing the monitor screen for extended periods of time may result in eye strain.**

For comfort and efficiency, observe the following guidelines when setting up and using your computer workstation:

- Position your computer so that the monitor and keyboard are directly in front of you as you work. Special shelves are commercially available to help you correctly position your keyboard.
- To reduce the risk of eye strain and neck/arm/back/shoulder pain from using the monitor for long periods of time, we suggest you to:
  1. Set the distance of the screen between 20 to 28 in. (50 - 70 cm) from your eyes.
  2. Blink frequently to moisten your eyes or wet your eyes with water after prolonged usage of the monitor.
  3. Take regular and frequent breaks for 20 minutes every two hours.
  4. Look away from your monitor and gaze at a distant object at 20 feet away for at least 20 seconds during the breaks.
  5. Perform stretches to relieve tension in the neck, arm, back, and shoulders during the breaks.
- Make sure that the monitor screen is at eye level or slightly lower when you are sitting in front of the monitor.
- Adjust the tilt of the monitor, its contrast, and brightness settings.
- Adjust the ambient lighting around you (such as overhead lights, desk lamps, and the curtains or blinds on nearby windows) to minimize reflections and glare on the monitor screen.
- Use a chair that provides good lower-back support.
- Keep your forearms horizontal with your wrists in a neutral, comfortable position while using the keyboard or mouse.
- Always leave space to rest your hands while using the keyboard or mouse.

- Let your upper arms rest naturally on both sides.
- Ensure that your feet are resting flat on the floor.
- When sitting, make sure that the weight of your legs is on your feet and not on the front portion of your seat. Adjust your chair's height or use a footrest if necessary to maintain a proper posture.
- Vary your work activities. Try to organize your work so that you do not have to sit and work for extended periods of time. Try to stand or get up and walk around at regular intervals.
- Keep the area under your desk clear of obstructions and cables or power cords that may interfere with comfortable seating or present a potential trip hazard.

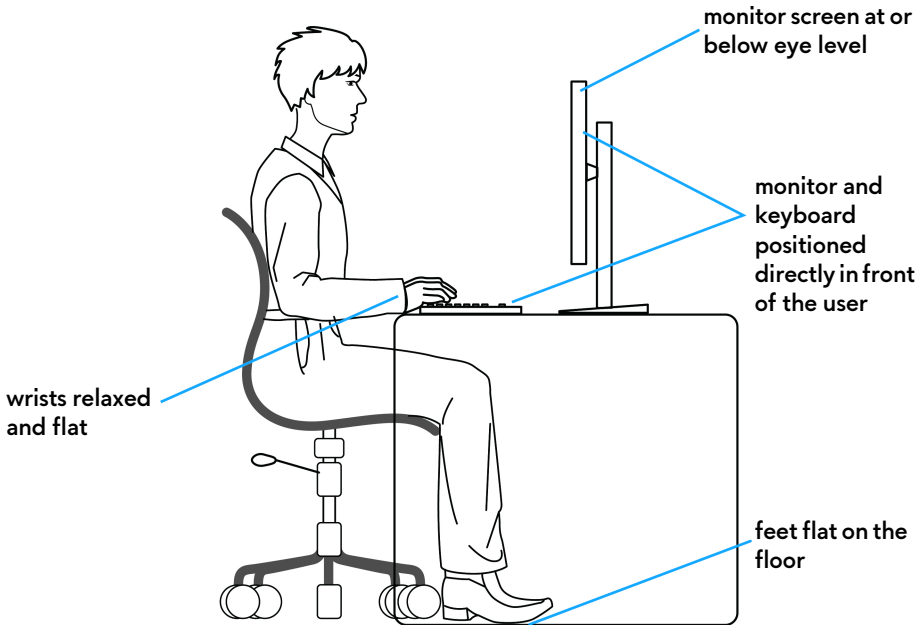



## Handling and moving your display

To ensure the monitor is handled safely when lifting or moving it, follow the guidelines mentioned below:

- Before moving or lifting the monitor, turn off your computer and the monitor.
- Disconnect all cables from the monitor.
- Place the monitor in the original box with the original packing materials.
- Hold the bottom edge and the side of the monitor firmly without applying excessive pressure when lifting or moving the monitor.

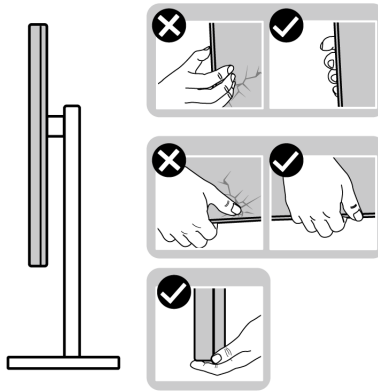

- When lifting or moving the monitor, ensure the screen is facing away from you and do not press on the display area to avoid any scratches or damage.

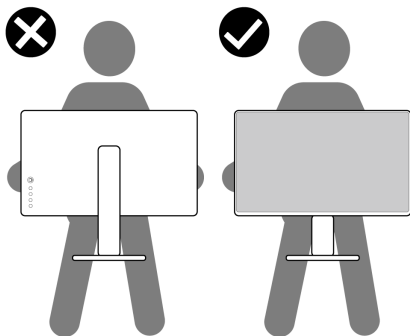

- When lifting or moving the monitor, do not turn the monitor upside down while holding the stand base or stand riser. This may result in accidental damage to the monitor or cause personal injury.

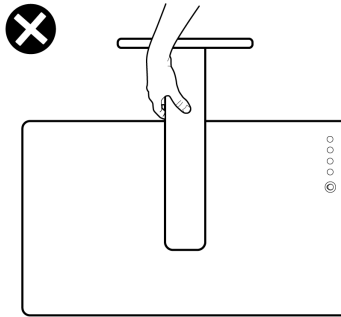

## Maintenance guidelines

### Cleaning your monitor

△ **CAUTION:** Read and follow the [Safety instructions](#) before cleaning the monitor.



⚠ **WARNING:** Before cleaning the monitor, unplug the monitor power cable from the electrical outlet.

For best practices, follow the instructions in the list below when unpacking, cleaning, or handling your monitor:

- To clean your anti-static screen, lightly dampen a soft, clean cloth with water. If possible, use a special screen-cleaning tissue or solution suitable for the anti-static coating. Do not use benzene, thinner, ammonia, abrasive cleaners, or compressed air.
- Use a lightly-dampened, warm cloth to clean the monitor. Avoid using detergent of any kind as some detergents leave a milky film on the monitor.
- If you notice white powder when you unpack your monitor, wipe it off with a cloth.
- Handle your monitor with care as a darker-colored monitor may get scratched and show white scuff marks more than a lighter-colored monitor.
- To help maintain the best image quality on your monitor, use a dynamically changing screen saver and turn off your monitor when not in use.

# Setting up the monitor

## Attaching the stand

-  **NOTE:** The stand is not factory-installed.
  -  **NOTE:** The following instructions are only applicable for the stand that was shipped with your monitor. If you are attaching a stand that you purchased from any other source, follow the set up instructions that were included with the stand.
  -  **CAUTION:** The following steps are important to protect your curved screen. Do follow the instructions below to finish up the installation.
1. Remove the stand riser and stand base from the packaging cushion.

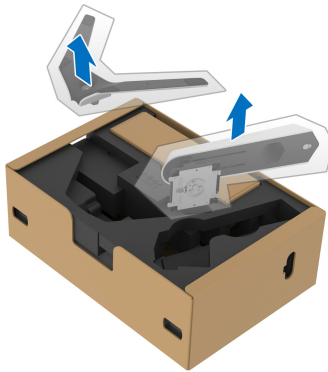

2. Align and place the stand riser on the stand base.
3. Open the screw handle at the bottom of the stand base and turn it clockwise to secure the stand assembly.
4. Close the screw handle.



5. Open the protective cover on the monitor to access the VESA slot on the monitor.

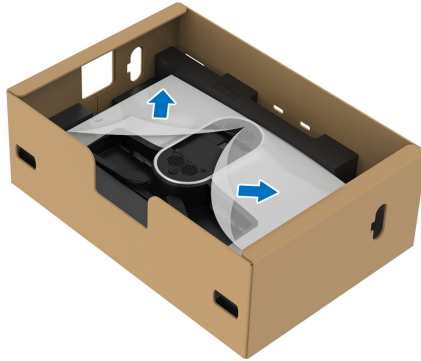

△ **CAUTION: When connecting the stand assembly to the display, do not place the stand riser directly on the display back panel. Doing so may damage the pogo pins on the stand due to misalignment.**

6. Carefully insert the tabs on the stand riser into the slots on the display back cover and lower the stand assembly to snap it into place.

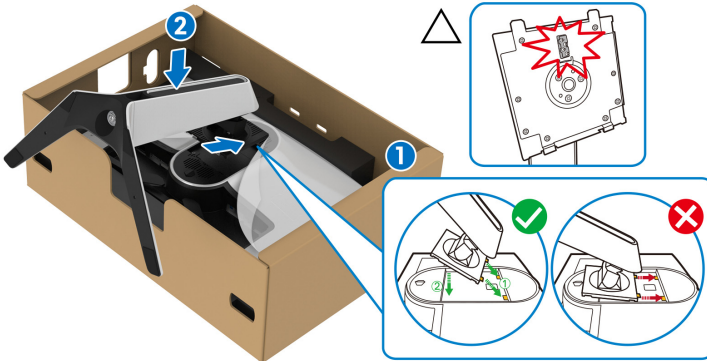

7. Route the power cable through the cable-management slot on the stand and then through the cable-management clip at the back of the display.

8. Connect the power cable to the monitor.

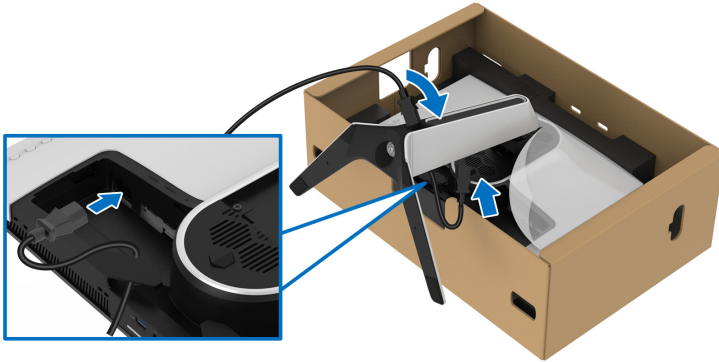

9. Route the required cables, such as USB 3.2 Gen1 (5 Gbps) upstream cable, USB 3.2 Gen1 (5 Gbps) downstream cables, HDMI cables, and DisplayPort cable through the cable-management slot on the stand.

**NOTE: The USB 3.2 Gen1 (5 Gbps) cables and HDMI cables are not shipped with your display, they are sold separately.**

10. Connect the required cables to the monitor.

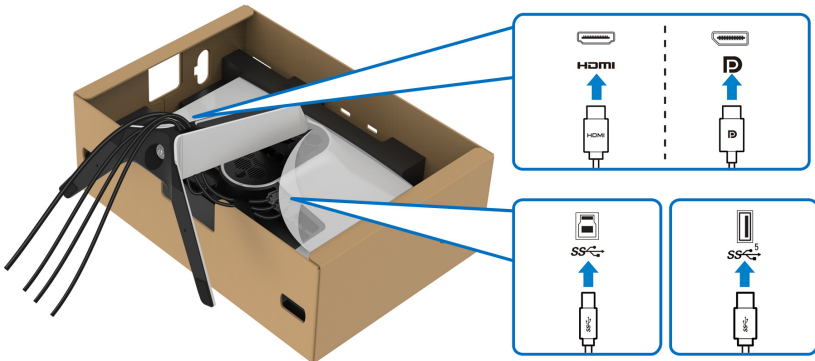

**NOTE: Dell monitors are designed to work optimally with Dell supplied inbox cables. Dell does not guarantee the video quality and performance when using non-Dell cables.**

**NOTE: Route each cable neatly so that the cables are organized before the I/O cover is attached.**

**△ CAUTION: Do not plug the power cable into the wall outlet or turn on the monitor until you are instructed to do so.**

11. Hold the stand riser and lift the monitor carefully, then place it on a flat surface.

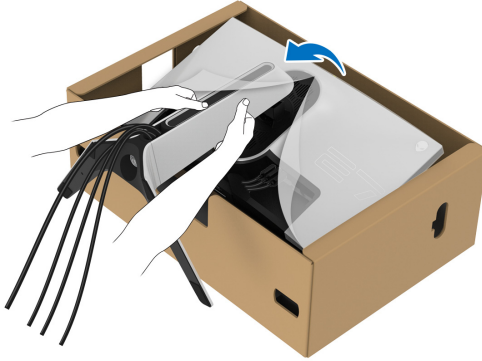

**△ CAUTION: Hold the stand riser firmly when lifting the monitor to avoid any accidental damage.**

12. Lift the protective cover from the monitor.

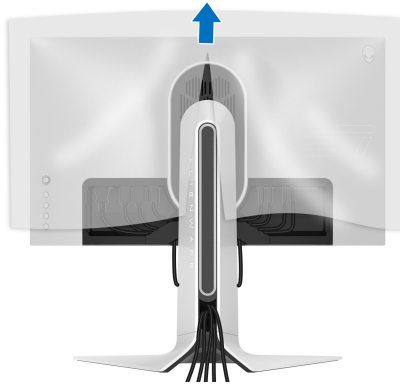

- Slide the tabs on the I/O cover into the slots on the display back cover until it snaps into place.

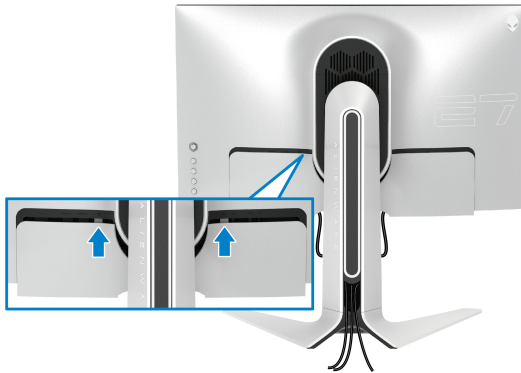

- NOTE:** Ensure that all cables pass through the I/O cover and cable-management slot on the stand riser.

## Connecting the computer

- WARNING:** Before you begin any of the procedures in this section, follow the [Safety instructions](#).

- NOTE:** Do not connect all cables to the computer at the same time.

- NOTE:** The images are for the purpose of illustration only. Appearance of the computer may vary.

To connect your monitor to the computer:

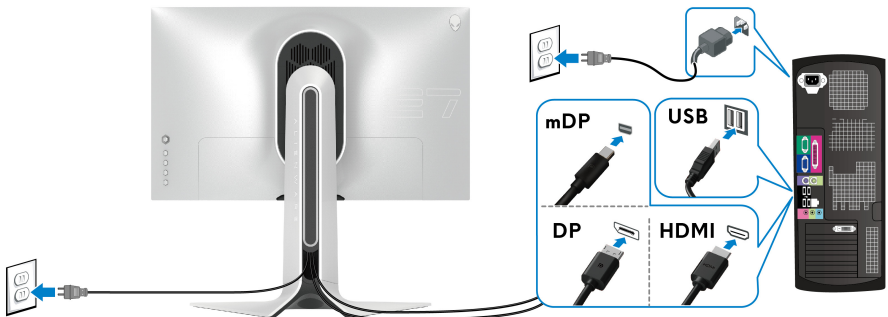



- Connect the other end of the DisplayPort cable (or Mini-DisplayPort to DisplayPort) or HDMI cable to your computer.

2. Connect the other end of the USB 3.2 Gen1 upstream cable to an appropriate USB 3.2 Gen1 port on your computer.
3. Connect the USB 3.2 Gen1 peripherals to the USB 3.2 Gen1 downstream ports on the monitor.
4. Plug the power cables for your computer and monitor into a wall outlet.
5. Turn on the monitor and the computer.

If your monitor displays an image, installation is complete. If it does not display an image, see [Common problems](#).

## Removing the monitor stand

-  **NOTE:** To prevent scratches on the display when removing the stand, ensure that the monitor is placed on a soft, clean surface.
-  **NOTE:** The following instructions are applicable only for removing the stand that was shipped with your monitor. If you are removing a stand that you purchased from any other source, follow the set up instructions that were included with the stand.

To remove the stand:

1. Turn off the monitor.
2. Disconnect the cables from the computer.
3. Place the monitor on a soft cloth or cushion.
4. Carefully slide and remove the I/O cover from the monitor.

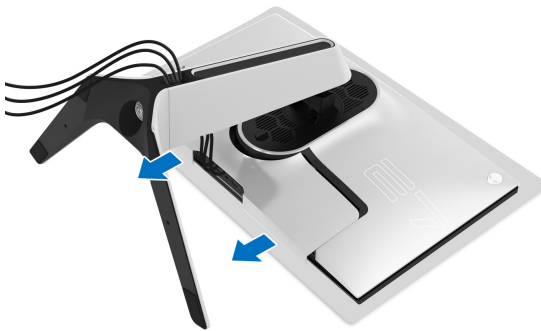



5. Disconnect the cables from the monitor and slide them out through the cable-management slot on the stand riser.

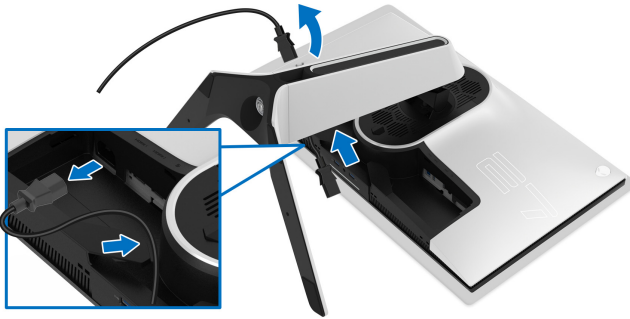

6. Press and hold the stand release button.

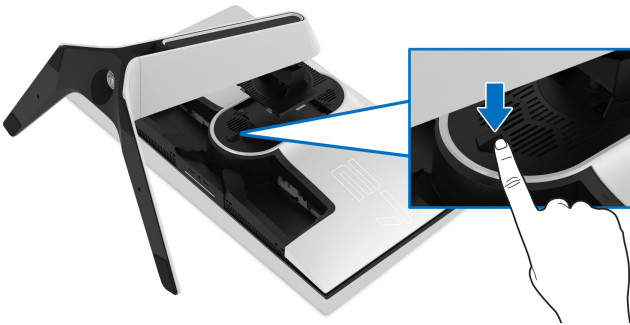

7. Lift the stand up and away from the monitor.



## VESA wall mounting (optional)

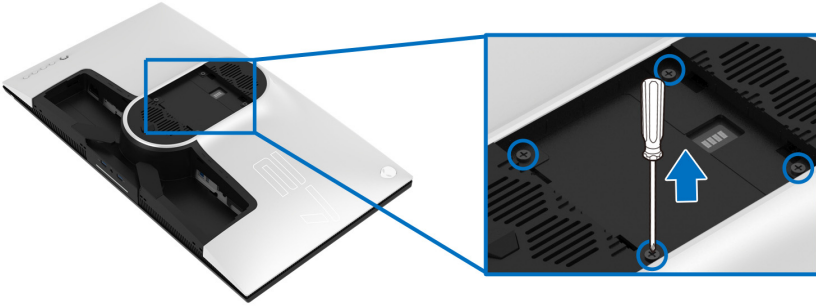

(Screw dimension: M4 x 10 mm)

Refer to the instructions that come with the VESA-compatible wall mounting kit.

1. Place the monitor panel on a soft cloth or cushion on a stable flat surface.
2. Remove the monitor stand. (See [Removing the monitor stand.](#))
3. Use a Phillips crosshead screwdriver to remove the four screws securing the plastic cover.
4. Attach the mounting bracket from the wall mounting kit to the monitor.
5. Mount the monitor on the wall. For more information, see the documentation that shipped with the wall mounting kit.

 **NOTE: For use only with UL-listed wall mount bracket with minimum weight or load bearing capacity of 25.2 kg.**

# Operating the monitor

## Power on the monitor

Press the power button to turn on the monitor.

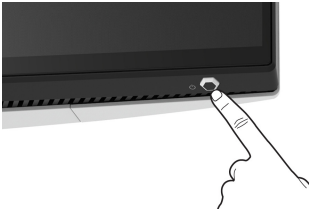

## Using the joystick control

Use the joystick control on the rear of the monitor to make OSD adjustments.

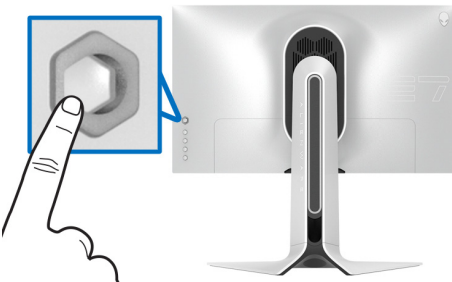

1. Press the joystick button to launch the OSD main menu.
2. Move the joystick up/down/left/right to toggle between options.
3. Press the joystick button again to confirm the settings and exit.

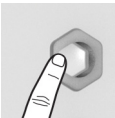
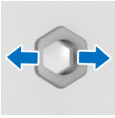
Joystick	Description
	<ul style="list-style-type: none"><li>▪ When the OSD menu is on, press the button to confirm the selection or save the settings.</li><li>▪ When the OSD menu is off, press the button to launch the OSD main menu. See <a href="#">Accessing the menu system</a>.</li></ul>
	<ul style="list-style-type: none"><li>▪ For 2-way (right and left) directional navigation.</li><li>▪ Move right to enter the submenu.</li><li>▪ Move left to exit from the submenu.</li><li>▪ Increases (right) or decreases (left) the parameters of selected menu item.</li></ul>

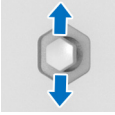



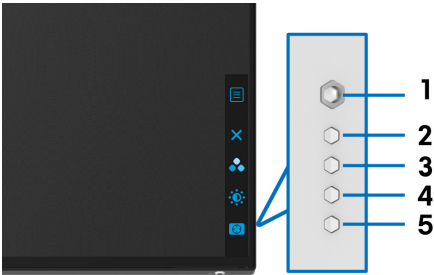

- For 2-way (up and down) directional navigation.
- Toggles between the menu items.
- Increases (up) or decreases (down) the parameters of selected menu item.

## Using the rear-panel controls

Use the control buttons on the rear of the monitor to access the OSD menu and shortcut keys.



The following table describes the rear-panel buttons:

Rear-panel button	Description
1  Menu	To launch the OSD main menu. See <a href="#">Accessing the menu system</a> .
2  Exit	To exit the OSD main menu.
3  Shortcut key/ Preset Modes	To specify a desired color mode from a preset list.
4  Shortcut key/ Brightness/Contrast	To directly access the <b>Brightness/Contrast</b> adjustment sliders.
5  Shortcut key/ Dark Stabilizer	To directly access the <b>Dark Stabilizer</b> adjustment slider.

When you press any of these button on the rear panel (including the joystick button), the OSD Status Bar appears to let you know the current settings of some OSD functions.

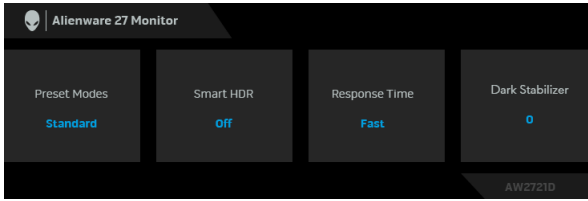

**NOTE:** The Smart HDR state is enabled automatically when your display detects HDR content. It cannot be enabled manually.

## Using the On-Screen Display (OSD) menu

### Accessing the menu system

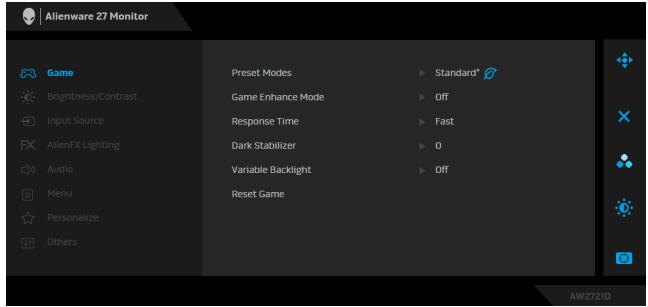
Icon	Menu and submenus	Description
	<b>Game</b>	Use this menu to personalize your visual gameplay experience.
		

---

**Preset Modes** Allows you to choose from the list of preset color modes.

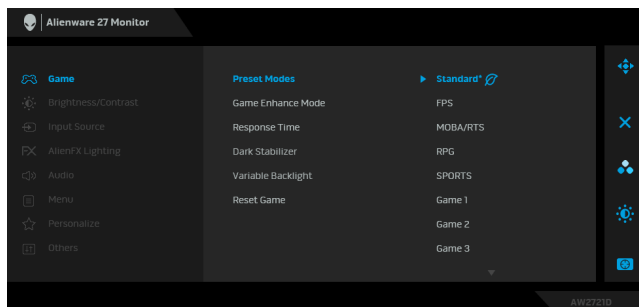

- **Standard\***: Loads the monitor's default color settings. This is the default preset mode. (\* means DisplayHDR-compliant)
- **FPS**: Loads color settings ideal for First-Person Shooter (FPS) games.
- **MOBA/RTS**: Loads color settings ideal for Multiplayer Online Battle Arena (MOBA) and Real-Time Strategy (RTS) games.
- **RPG**: Loads color settings ideal for Role-Playing Games (RPG).
- **SPORTS**: Loads color settings ideal for sports games.
- **Game 1/Game 2/Game 3**: Allows you to customize the **Response Time**, color, and **Dark Stabilizer** settings for your gaming needs.
- **ComfortView**: Decreases the level of blue light emitted from the screen to make viewing more comfortable for your eyes.

**WARNING: The possible long-term effects of blue light emission from the monitor may cause personal injury such as digital eye strain, eye fatigue and damage to the eyes. Using monitor for extended periods of time may also cause pain in parts of body such as neck, arm, back and shoulder. For more information, see [Ergonomics](#).**

- 
- Preset Modes**
- **Warm:** Presents colors at lower color temperatures. The screen appears warmer with a red/yellow tint.
  - **Cool:** Presents colors at higher color temperatures. The screen appears cooler with a blue tint.
  - **Custom Color:** Allows you to manually adjust the color settings. Use the joystick to adjust the three colors (R, G, B) values and create your own preset color modes.

---

**Game Enhance Mode** The feature offers three available functions to enhance your gameplay experience.

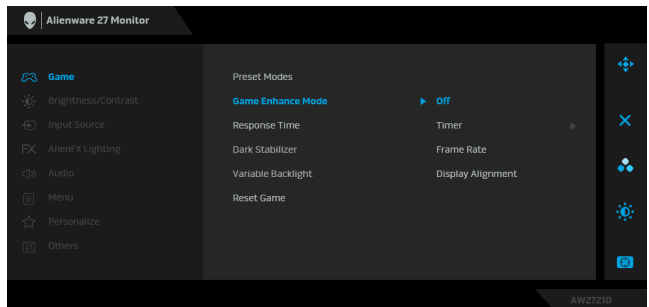

- **Off**

Select to disable the functions under **Game Enhance Mode**.

- **Timer**

Allows you to disable or enable the timer at the upper left corner of the display. The timer shows the time elapsed since the game starts. Select an option from the time-interval list to keep you aware of the remaining time.

- **Frame Rate**

Selecting **On** allows you to display the current frames per second when playing games. The higher the rate, the smoother the motion appears.

- **Display Alignment**

Activate the function to help ensure the perfect alignment of the video contents from multiple displays.

---

---

**Response Time** Allows you to set the **Response Time** to **Fast**, **Super Fast** or **Extreme**.

---

**Dark Stabilizer** The feature improves the visibility in the dark gaming scenarios. The higher the value (between 0 to 3), the better visibility in dark area of the display image.

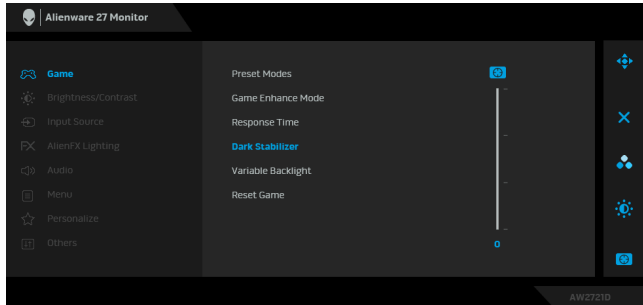

---

**Variable Backlight** Optimally adjusts display back-light by controlling the brightness and dimming of the display based on the preset mode selected.

- **Mode 0:** Ideal for gameplay.
- **Mode 1:** Suitable for hybrid usage such as playing games and general desktop usage. When the monitor is displaying the HDR content, this is the default mode.
- **Mode 2:** Suitable for desktop usage, photo editing, and so on.
- **Off:** When the monitor is displaying the SDR content, this is the default setting; When HDR content is displayed, this option is disabled.

**NOTE:** When **Mode 0**, **Mode 1**, or **Mode 2** is selected, it is normal to experience change in localized back-light brightness based on the content displayed.

---

**Reset Game** Resets all settings under the **Game** menu to the factory defaults.

---





## Brightness/ Contrast

Use this menu to activate **Brightness/Contrast** adjustment.

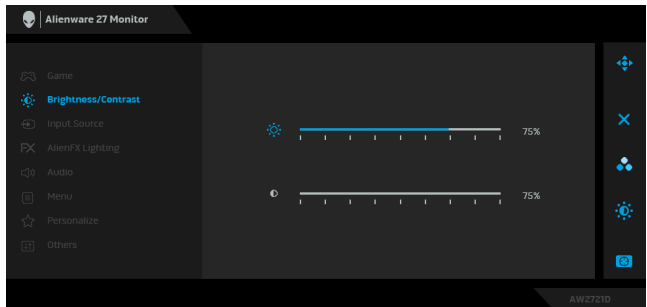

### Brightness

**Brightness** adjusts the luminance of the backlight.

Move the joystick right to increase the brightness level or move the joystick left to decrease the brightness level (min. 0 / max. 100).

### Contrast

Adjust **Brightness** first, and then adjust **Contrast** only if further adjustment is necessary.

Move the joystick right to increase the contrast level or move the joystick left to decrease the contrast level (min. 0 / max. 100).

The **Contrast** function adjusts the degree of difference between darkness and lightness on the monitor screen.



## Input Source

Use the **Input Source** menu to select between the different video signals that may be connected to your monitor.

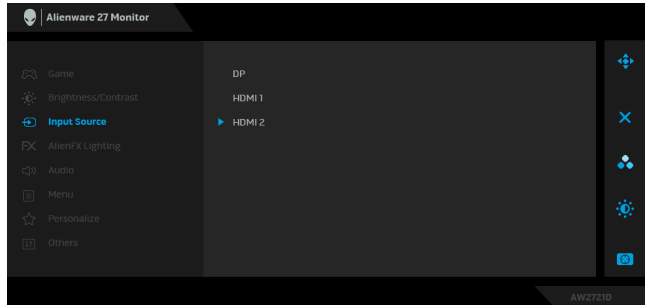

---

### DP

Select the **DP** input when you are using the DisplayPort (DP) connector. Press the joystick button to confirm the selection.

---

### HDMI 1

---

### HDMI 2

Select the **HDMI 1** or **HDMI 2** input when you are using the HDMI connector. Press the joystick button to confirm the selection.

---



## AlienFX Lighting

Use this menu to adjust the LED light settings for the Power button, Alienware logo, downlights on the bottom of the monitor, and the light stripe on the stand.

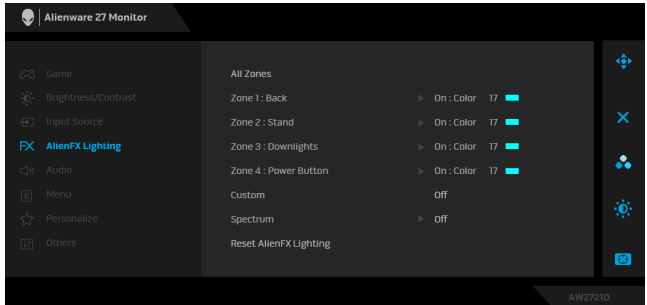

Before making any adjustments, select any or all of these 4 zones from the submenus. The illustration below indicates the lighting zones.

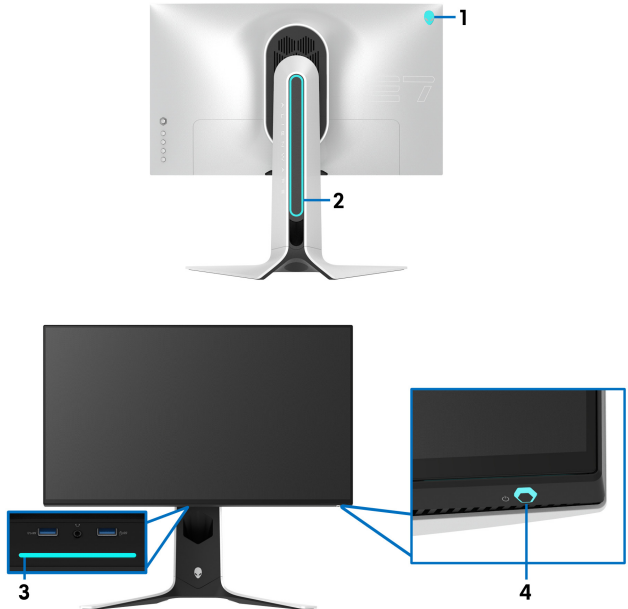

## All Zones

### Zone 1: Back

### Zone 2: Stand

### Zone 3: Downlights

### Zone 4: Power Button

To specify an LED lighting color for the selected area, select **On** and move the joystick to highlight the **Custom Color** option.

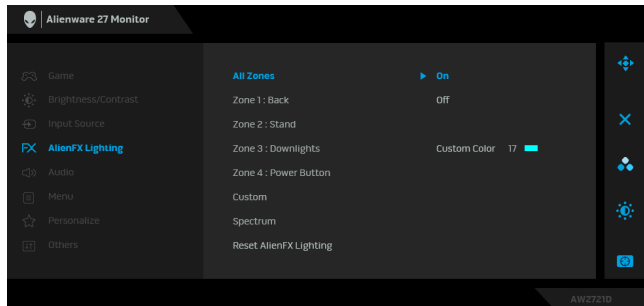

Then you can make a selection from the list of 20 available colors by moving the joystick up or down.

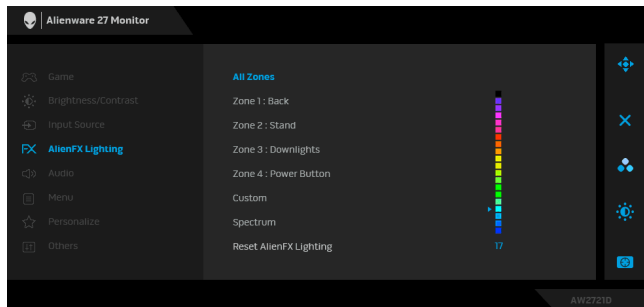

---

The following table depicts the color number and the RGB codes used for the 20 LED colors.

No.	R	G	B
1	0	0	0
2	63	0	255
3	100	0	240
4	255	0	255
5	239	12	175
6	255	0	89
7	255	0	0
8	255	45	0
9	255	75	0
10	255	120	0
11	204	255	0
12	127	255	0
13	76	255	0
14	0	255	0
15	0	255	25
16	0	255	63
17	0	240	240
18	0	63	255
19	0	25	255
20	0	0	255

To turn off the AlienFX lights, select **Off**.

**NOTE:** These functions are only available when **Spectrum** is disabled.

---

**Custom**

It is a read-only menu. When you use **Color** or/and **Spectrum** to make LED lighting adjustments, this menu status shows **Off**; when you make the LED lighting adjustments through AlienFX application, the status changes to **On**.

---

---

## Spectrum

When you select **On**, the AlienFX lights of 4 zones glow and change colors in the sequence of the color spectrum: red, orange, yellow, green, blue, indigo, and violet.

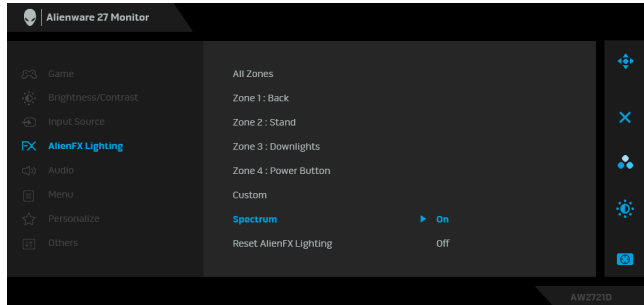

---

## Reset AlienFX Lighting

Resets all settings under the **AlienFX Lighting** menu to the factory defaults.



## Audio

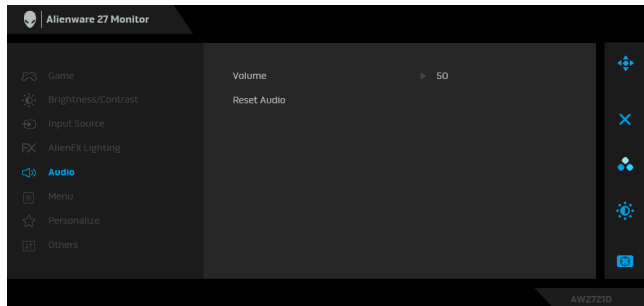

---

## Volume

Allows you to set the volume level of headphone output.

Use the joystick to adjust the volume level from 0 to 100.

---

## Reset Audio

Resets all settings under the **Audio** menu to the factory defaults.

---



## Menu

Select this option to adjust the settings of the OSD, such as, the languages of the OSD, the amount of time the menu remains on screen, and so on.

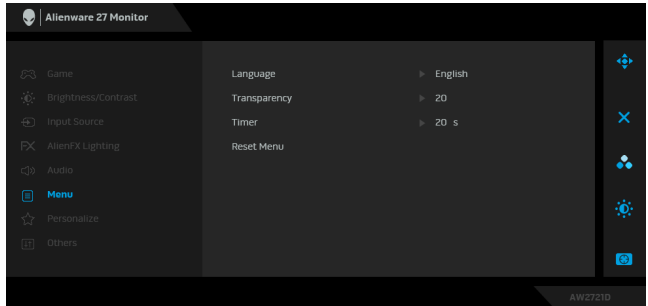

### Language

Sets the OSD display to one of the eight languages (English, Spanish, French, German, Brazilian Portuguese, Russian, Simplified Chinese, or Japanese).

### Transparency

Select this option to change the menu transparency by moving the joystick up or down (min. 0/max. 100).

### Timer

Sets the length of time for the OSD to remain active after you move the joystick or press a button. Move the joystick to adjust the slider in 1 second increments, from 5 to 60 seconds.

### Reset Menu

Resets all settings under the **Menu** menu to the factory defaults.



## Personalize

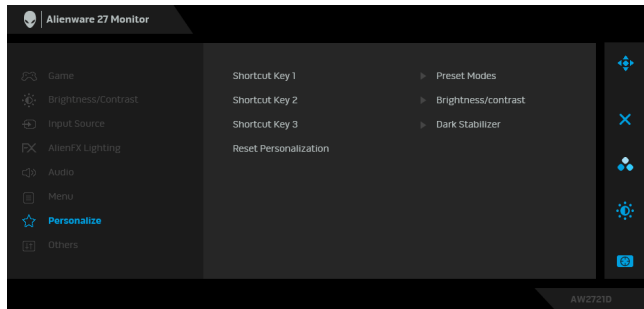

**Shortcut Key 1** Allows you to choose a feature from **Preset Modes**, **Game Enhance Mode**, **Dark Stabilizer**, **Brightness/Contrast**, **Input Source**, or **Volume** and set it as a shortcut key.

**Reset Personalization** Resets all settings under the **Personalize** menu to the factory defaults.



## Others

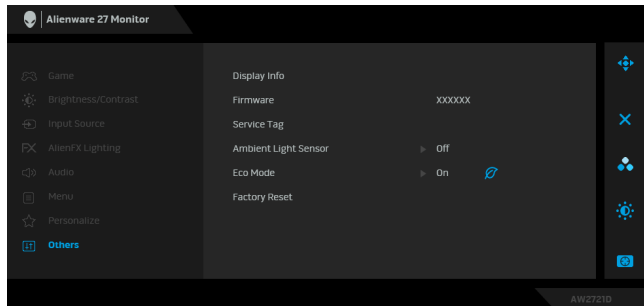

**Display Info** Displays the monitor's current settings.

**Firmware** Displays the firmware version of your monitor.

**Service Tag** Displays the Service Tag of your monitor. The Service Tag is a unique alphanumeric identifier that is required when you contact Dell technical support, access warranty information, search for latest drivers on Dell support website and so on.

**Ambient Light Sensor** When you turn it **On**, the monitor automatically adjusts the brightness of the display back-light based on ambient light conditions. The default setting is **Off**.

**NOTE:** When HDR content is displayed, this option is disabled.



---

**Eco Mode**

When the computer goes into standby mode, the **Eco Mode** enables the monitor to go into Standby mode as well. The default setting is **On**. Selecting **Off** may prevent the monitor from going into Standby mode.

**NOTE:** Pressing any button (including the joystick button) on the rear panel of the monitor may also wake up the monitor after it goes into Standby mode.

---

**Factory Reset**

Resets all OSD settings to the factory defaults.

---

**OSD warning message**

When you adjust the **Brightness** level for the first time, the following message appears:

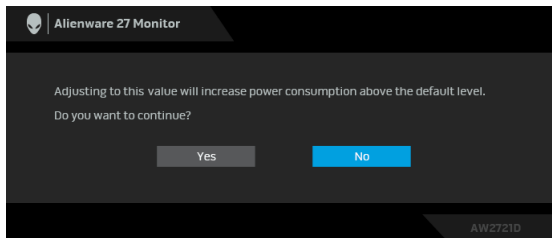

**NOTE:** If you select **Yes**, the message will not appear next time when you intend to change the **Brightness** setting.

When you change the default setting of power saving features for the first time, such as **Eco Mode** or **Preset Modes**, the following message appears:

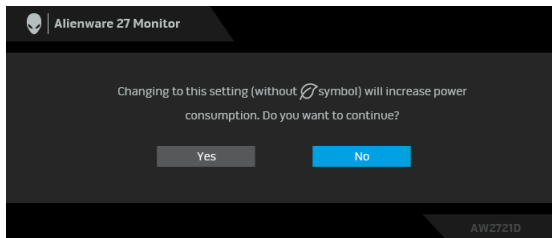

**NOTE:** If you select **Yes** for either of the features mentioned above, the message will not appear next time when you intend to change the settings of these features. When you perform a factory reset, the message will appear again.

When **Factory Reset** is selected, the following message appears:

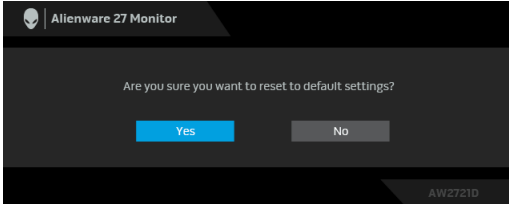

See [Troubleshooting](#) for more information.

## Setting the maximum resolution

To set the maximum resolution for the monitor:

In Windows 7, Windows 8, and Windows 8.1:

1. For Windows 8 and Windows 8.1 only, select the Desktop tile to switch to classic desktop.
2. Right-click on the desktop and click **Screen Resolution**.
3. Click the Dropdown list of the Screen Resolution and select **2560 x 1440**.
4. Click **OK**.

In Windows 10:

1. Right-click on the desktop and click **Display settings**.
2. Click **Advanced display settings**.
3. Click the dropdown list of **Resolution** and select **2560 x 1440**.
4. Click **Apply**.

If you do not see 2560 x 1440 as an option, you may need to update your graphics driver. Depending on your computer, complete one of the following procedures:

If you have a Dell desktop or a laptop:

- Go to [www.dell.com/support](http://www.dell.com/support), enter your service tag, and download the latest driver for your graphics card.

If you are using a non-Dell computer (laptop or desktop):

- Go to the support site for your computer and download the latest graphic drivers.
- Go to your graphics card website and download the latest graphic drivers.

## Using the tilt, swivel, and vertical extension

**NOTE:** The following instructions are applicable only for attaching the stand that was shipped with your monitor. If you are attaching a stand that you purchased from any other source, follow the set up instructions that were included with the stand.

### Tilt and swivel extensions

With the stand attached to the monitor, you can tilt and swivel the monitor for the most comfortable viewing angle.

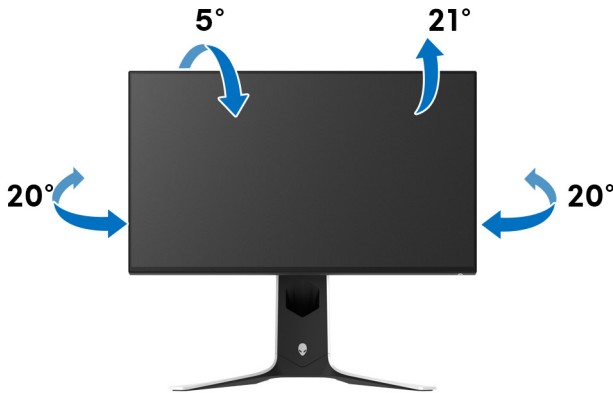

**NOTE:** The stand is not factory-installed.

### Vertical extension

**NOTE:** The stand extends vertically up to 130 mm. The figure below illustrates how to extend the stand vertically.

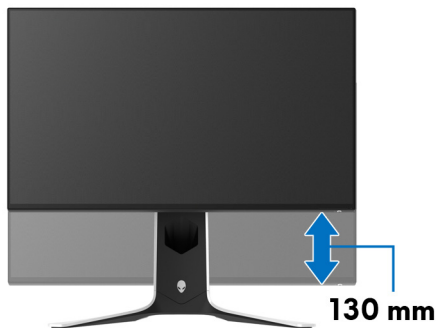

## Rotating the display

Before you rotate the display, ensure it is completely extended vertically and completely tilted up to avoid hitting the bottom edge of the monitor.



## Rotate clockwise

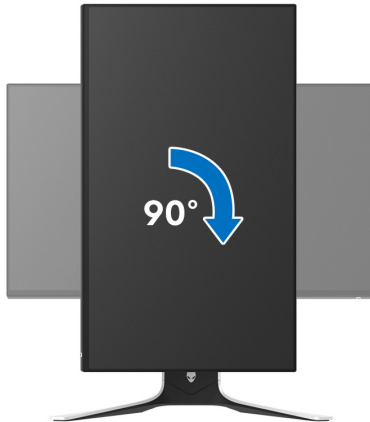

## Rotate counterclockwise

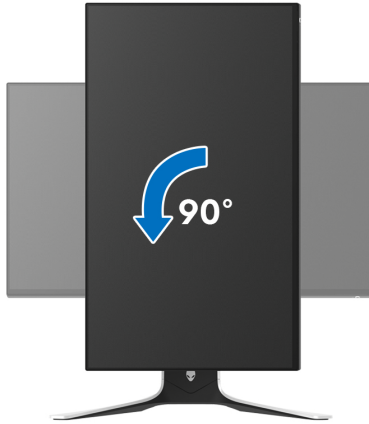

- NOTE: To use the Display Rotation function (Landscape versus Portrait view) with your Dell computer, you require an updated graphics driver that is not included with this monitor. To download the graphics driver, go to [www.dell.com/support](http://www.dell.com/support) and see the Download section for Video Drivers for latest driver updates.
- NOTE: In the Portrait mode, you may experience performance degradation when using graphic-intensive applications such as 3D gaming.

## Adjusting the rotation display settings of your system

After you have rotated your monitor, you need to complete the procedure below to adjust the Rotation Display Settings of your system.

 **NOTE: If you are using the monitor with a non-Dell computer, you need to go the graphics driver website or your computer manufacturer website for information on rotating the 'contents' on your display.**

To adjust the Rotation Display Settings:

1. Right-click on the desktop and click **Properties**.
2. Select the **Settings** tab and click **Advanced**.
3. If you have an ATI graphics card, select the **Rotation** tab and set the preferred rotation.
4. If you have an NVIDIA graphics card, click the **NVIDIA** tab, in the left-hand column select **NVRotate**, and then select the preferred rotation.
5. If you have an Intel<sup>®</sup> graphics card, select the **Intel** graphics tab, click **Graphic Properties**, select the **Rotation** tab, and then set the preferred rotation.

 **NOTE: If you do not see the rotation option or it is not working correctly, go to [www.dell.com/support](http://www.dell.com/support) and download the latest driver for your graphics card.**

# Using AlienFX application

You can configure the LED lighting effects across multiple distinct zones on your Alienware monitor through AlienFX in AWCC (Alienware Command Center).

 **NOTE: If you have an Alienware Gaming Desktop or Laptop, you can directly access AWCC to control the lightings.**

 **NOTE: For more information, see Alienware Command Center Online Help.**

## Prerequisites

Before installing the AWCC on a non-Alienware system:

- Ensure the OS of your computer is Windows 10 R3 or later.
- Ensure your internet connection is active.
- Ensure that the supplied USB 3.2 Gen1 (5 Gbps) upstream cable is connected to both the Alienware monitor and the computer.

## Installing AWCC through Windows update

1. The AWCC application is downloaded and will be automatically installed. The installation takes a few minutes to complete.
2. Navigate to the program folder to ensure that the installation is successful. Alternatively, you can find the AWCC application in the **Start** menu.
3. Launch AWCC and perform the following steps to download the additional software components:
  - In the **Settings** window, click **Windows Update**, and then click **Check for updates** to check the Alienware driver update progress.
  - If the driver update is not responding in your computer, install AWCC from the Dell Support website.

## Installing AWCC from the Dell Support website

1. Enter AW2721D in the query field at [www.dell.com/support/drivers](http://www.dell.com/support/drivers), and download the latest version of the following items:
  - Alienware Command Center Application
  - Alienware Gaming Monitor Control Center Driver
2. Navigate to the folder in which you saved the setup files.
3. Double-click the setup file and follow the on-screen instructions to complete the installation.

## Navigating the AlienFX window

With the Alienware Command Center, AlienFX allows you to control the LED lighting colors and transition effects for your Alienware monitor.

In the AWCC home screen, click **FX** in the top menu bar to access the home screen of AlienFX.

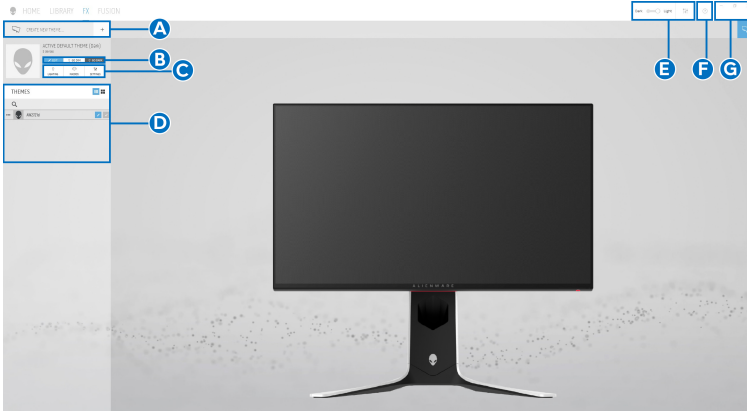

The following table describes the functions and features on the home screen:

No.	Functions	Descriptions
<b>A</b>	<b>CREATE NEW THEME...</b>	Click  and then enter a name in the text box to add a theme.
<b>B</b>	Edit controls	<ul style="list-style-type: none"> <li>▪ <b>EDIT:</b> Provides options for you to customize lighting settings for your theme.</li> <li>▪ <b>GO DIM:</b> Makes the light dimmer.</li> <li>▪ <b>GO DARK:</b> Turns off the light.</li> </ul>
<b>C</b>	Theme components	You can use these components ( <b>LIGHTING, MACROS, SETTINGS</b> ) to make the selected theme as an active theme.
<b>D</b>	<b>THEMES</b> list	Displays the themes in list view or grid view.
<b>E</b>	Background controls	Adjusts the background animation effects.
<b>F</b>	Help	Click it to access the AWCC Online Help.
<b>G</b>	Window controls	You can use the buttons to minimize, maximize, or restore the size of the window. When  is selected, the application will close.



When you start to customize a theme, you should see the following screen:



**Screen with the front view of monitor**

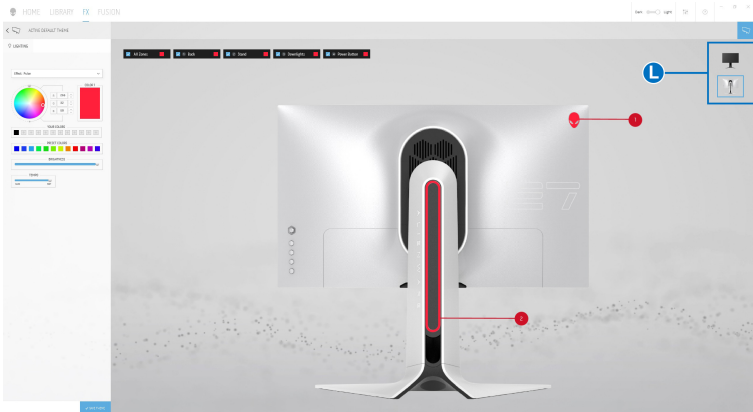

**Screen with the back view of monitor**

The following table describes the functions and features on the screen:

No.	Functions	Descriptions
<b>H</b>	<b>LIGHTING</b> panel	Use the controls in this panel to set up lighting effects for a theme. See <a href="#">Setting lighting effects</a> for details.
<b>I</b>	<b>SAVE THEME</b>	Click to save all adjustments and changes for the theme.
<b>J</b>	Zone selection	To make adjustments for a single zone, click the specific check box. To make adjustments for all zones, click the <b>All Zones</b> check box.

<b>K</b>	Live preview	The lighting zones are with numbered callouts. You may select a single zone by clicking the number on the image. When you make lighting adjustments, the preview of the monitor displays the new effects simultaneously.
<b>L</b>	Thumbnails	Displays the thumbnails of the Alienware monitors connected to your computer. The image displayed in the live preview area is selected from this thumbnail list.

## Creating a theme

To create a theme with your preferred lighting settings:

1. Launch AWCC.
2. Click **FX** in the top menu bar to access the home screen of AlienFX.
3. In the top-left corner of the window, click  to create a new theme.
4. In the **CREATE NEW THEME** text box, type the theme name.
5. Specify the lighting zone(s) for which you want to make lighting adjustments by:
  - selecting the zone check box(es) above the live preview area, or
  - clicking the numbered callout on the image of monitor
6. In the **LIGHTING** panel, select your preferred lighting effects from the drop-down list, including **Morph**, **Pulse**, **Color**, **Spectrum**, **Breathing**, and **Static Default Blue**. See [Setting lighting effects](#) for details.

 **NOTE: The Spectrum option is only available when you select All Zones to make lighting adjustments.**

7. Repeat step 5 and step 6 to make more configuration options available to your preference.
8. When done, click **SAVE THEME**. A toast notification appears in the right-bottom corner of the screen.

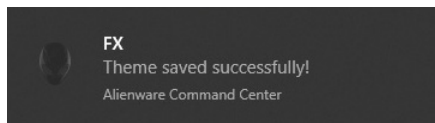



## Setting lighting effects

The **LIGHTING** panel provides various lighting effects. You may click **Effect** to open a drop-down menu with available options.

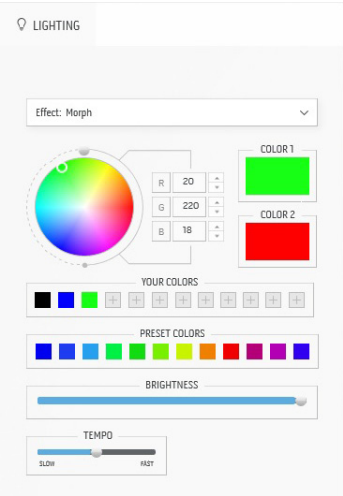

 **NOTE:** The options displayed may vary depending on the lighting zone(s) you specified.

The following table provides an overview of different options:

Morph	Descriptions
	<p>The effect changes the light color into another through a seamless transition.</p> <p>To make the adjustments:</p> <ol style="list-style-type: none"><li>1. Pick a preferred color from the color palette or the list of <b>PRESET COLORS</b>. The selected color and its RGB color codes will be displayed on the right field.</li></ol> <p><b>NOTE:</b> To change the color, use the up and down arrow buttons beside the R/G/B boxes to edit the color codes.</p> <ol style="list-style-type: none"><li>2. To add the selected color to the list of <b>YOUR COLORS</b> for quick access in the future, click . At most 12 colors can be added to the list.</li></ol> <p><b>NOTE:</b> To remove an existing color chip from the list, right-click on it.</p> <ol style="list-style-type: none"><li>3. Repeat the previous steps to specify <b>Color 2</b> to be the ending light color.</li><li>4. Drag the <b>BRIGHTNESS</b> slider to adjust the lightness of the color.</li><li>5. Drag the <b>TEMPO</b> slider to adjust the transition speed.</li></ol>

---

## Pulse

## Descriptions

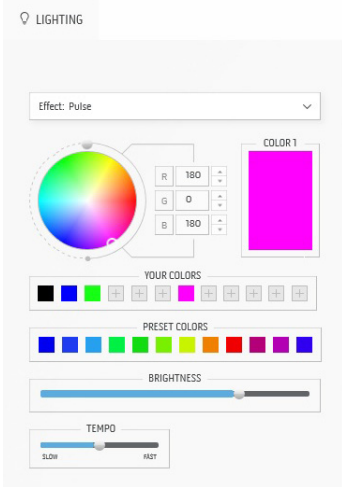

The effect makes the light flash with a short pause.  
To make the adjustments:

1. Pick a preferred color from the color palette or the list of **PRESET COLORS**. The selected color and its RGB color codes will be displayed on the right field.

**NOTE:** To change the color, use the up and down arrow buttons beside the R/G/B boxes to edit the color codes.

2. To add the selected color to the list of **YOUR COLORS** for quick access in the future, click . At most 12 colors can be added to the list.

**NOTE:** To remove an existing color chip from the list, right-click on it.

3. Drag the **BRIGHTNESS** slider to adjust the lightness of the color.
4. Drag the **TEMPO** slider to adjust the pulsing speed.

---

## Color

## Descriptions

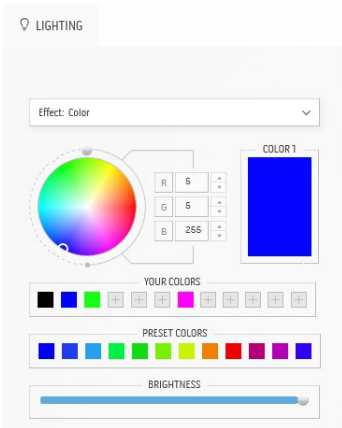

The effect makes the LED light in a single static color.

To make the adjustments:

1. Pick a preferred color from the color palette or the list of **PRESET COLORS**. The selected color and its RGB color codes will be displayed on the right field.

**NOTE:** To change the color, use the up and down arrow buttons beside the R/G/B boxes to edit the color codes.

2. To add the selected color to the list of **YOUR COLORS** for quick access in the future, click . At most 12 colors can be added to the list.

**NOTE:** To remove an existing color chip from the list, right-click on it.

3. Drag the **BRIGHTNESS** slider to adjust the lightness of the color.

---

## Spectrum

## Descriptions

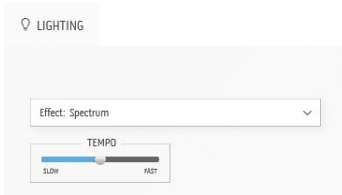

The effect makes the light change in sequence of spectrum: red, orange, yellow, green, blue, indigo, and violet.

You can drag the **TEMPO** slider to adjust the transition speed.

**NOTE:** The option is available only when you select **All Zones** to make lighting adjustments.

---

## Breathing

## Descriptions

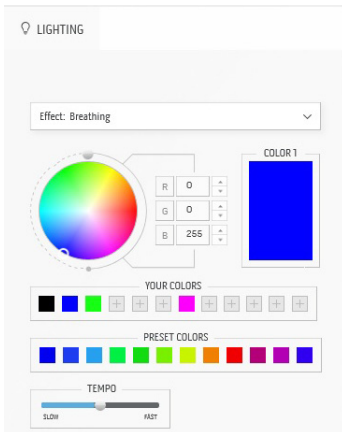

The effect makes the light change from bright to dim.

To make the adjustments:

1. Pick a preferred color from the color palette or the list of **PRESET COLORS**. The selected color and its RGB color codes will be displayed on the right field.

**NOTE:** To change the color, use the up and down arrow buttons beside the R/G/B boxes to edit the color codes.

2. To add the selected color to the list of **YOUR COLORS** for quick access in the future, click . At most 12 colors can be added to the list.
3. Drag the **TEMPO** slider to adjust the transition speed.

---

## Static Default Blue

## Descriptions

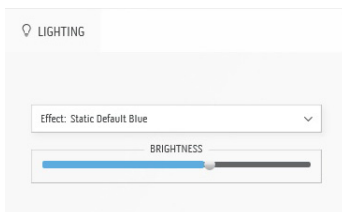

This effect makes the light solid blue.

You can drag the **BRIGHTNESS** slider to change the intensity of the color from strong to light.

**NOTE:** The option is available only when you select **All Zones** to make lighting adjustments.

# Troubleshooting

**⚠ WARNING:** Before you begin any of the procedures in this section, follow the [Safety instructions](#).

## Self-test

Your monitor provides a self-test feature that allows you to check whether your monitor is functioning properly. If your monitor and computer are properly connected but the monitor screen remains dark, run the monitor self-test by performing the following steps:

1. Turn off both your computer and the monitor.
2. Disconnect the video cable from the back of the computer. To ensure proper Self-Test operation, disconnect all cables from the computer.
3. Turn on the monitor.

**📎 NOTE:** A dialog box with text should appear on the screen, indicating that the monitor is working correctly and it is not receiving a video signal. While in self-test mode, the power LED blinks white (default color).

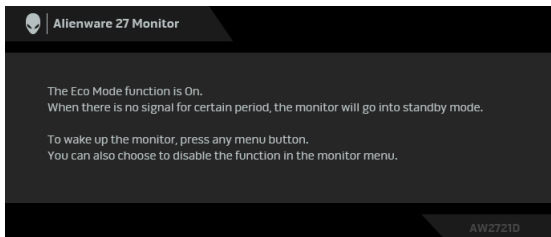

**When Eco Mode is On**

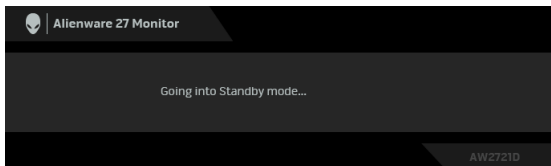

**When Eco Mode is Off**

**📎 NOTE:** This dialog box also appears during normal operation, if the video cable is disconnected or damaged.

4. Turn off your monitor and reconnect the video cable; then turn on both your computer and the monitor.

After performing the above steps, if the monitor displays no video output, then the problem may be with the graphics card or the computer.

## Built-in diagnostics

Your monitor has a built-in diagnostic tool that helps you determine if the screen abnormality you are experiencing is an inherent problem with your monitor, or with your computer and video card.

 **NOTE: You can run the built-in diagnostics only when the video cable is unplugged and the monitor is in self-test mode.**

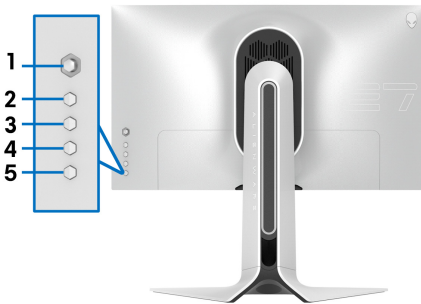

To run the built-in diagnostics:

1. Ensure that the screen is clean (no dust particles on the surface of the screen).
2. Press and hold **Button 3** for five seconds. A gray screen appears after one second.
3. Observe if the screen has any defects or abnormalities.
4. Press **Button 3** again. The color of the screen changes to red.
5. Observe if the screen has any defects or abnormalities.
6. Repeat steps 4 and 5 to inspect the display in green, blue, black, and white screens.

The test is complete when the white screen appears. To exit, press **Button 3** again.

If you do not detect any screen abnormalities upon using the built-in diagnostic tool, the monitor is functioning properly. Check the video card and computer.

## Common problems

The following table contains general information about common monitor problems you might encounter and the possible solutions:

Common symptoms	What you experience	Possible solutions
No Video/ Power LED off	No picture	<ul style="list-style-type: none"><li>▪ Ensure that the video cable connecting the monitor and the computer is properly connected and secure.</li><li>▪ Verify that the power outlet is functioning properly using any other electrical equipment.</li><li>▪ Ensure that the power button is depressed fully.</li><li>▪ Ensure that the correct input source is selected in the <b>Input Source</b> menu.</li></ul>
No Video/ Power LED on	No picture or no brightness	<ul style="list-style-type: none"><li>▪ Increase brightness and contrast controls in the <b>Brightness/Contrast</b> menu.</li><li>▪ Perform monitor self-test feature check.</li><li>▪ Check for bent or broken pins in the video cable connector.</li><li>▪ Run the built-in diagnostics.</li><li>▪ Ensure that the correct input source is selected in the <b>Input Source</b> menu.</li></ul>
Poor Focus	Picture is fuzzy, blurry, or ghosting	<ul style="list-style-type: none"><li>▪ Eliminate video extension cables.</li><li>▪ Reset the monitor to factory settings.</li><li>▪ Change the video resolution to the correct aspect ratio.</li></ul>
Shaky/Jittery Video	Wavy picture or fine movement	<ul style="list-style-type: none"><li>▪ Reset the monitor to factory settings.</li><li>▪ Check environmental factors.</li><li>▪ Relocate the monitor and test in another room.</li></ul>



Missing Pixels	LCD screen has spots	<ul style="list-style-type: none"> <li>▪ Cycle power On-Off.</li> <li>▪ Pixel that is permanently off is a natural defect that can occur in LCD technology.</li> <li>▪ For more information on Dell Monitor Quality and Pixel Policy, see Dell support site: <a href="http://www.dell.com/pixelguidelines">www.dell.com/pixelguidelines</a>.</li> </ul>
Stuck-on Pixels	LCD screen has bright spots	<ul style="list-style-type: none"> <li>▪ Cycle power On-Off.</li> <li>▪ Pixel that is permanently off is a natural defect that can occur in LCD technology.</li> <li>▪ For more information on Dell Monitor Quality and Pixel Policy, see Dell support site: <a href="http://www.dell.com/pixelguidelines">www.dell.com/pixelguidelines</a>.</li> </ul>
Brightness Problems	Picture too dim or too bright	<ul style="list-style-type: none"> <li>▪ Reset the monitor to factory settings.</li> <li>▪ Adjust brightness and contrast controls in the <b>Brightness/Contrast</b> menu.</li> </ul>
Geometric Distortion	Screen not centered correctly	<ul style="list-style-type: none"> <li>▪ Reset the monitor to factory settings.</li> </ul>
Horizontal/Vertical Lines	Screen has one or more lines	<ul style="list-style-type: none"> <li>▪ Reset the monitor to factory settings.</li> <li>▪ Perform monitor self-test feature check and determine if these lines are also in self-test mode.</li> <li>▪ Check for bent or broken pins in the video cable connector.</li> <li>▪ Run the built-in diagnostics.</li> </ul>
Synchronization Problems	Screen is scrambled or appears torn	<ul style="list-style-type: none"> <li>▪ Reset the monitor to factory settings.</li> <li>▪ Perform monitor self-test feature check to determine if the scrambled screen appears in self-test mode.</li> <li>▪ Check for bent or broken pins in the video cable connector.</li> <li>▪ Restart the computer in the <i>safe mode</i>.</li> </ul>
Safety Related Issues	Visible signs of smoke or sparks	<ul style="list-style-type: none"> <li>▪ Do not perform any troubleshooting steps.</li> <li>▪ <b>Contact Dell</b> immediately.</li> </ul>

Intermittent Problems	Monitor malfunctions on & off	<ul style="list-style-type: none"> <li>▪ Ensure that the video cable connecting the monitor to the computer is connected properly and is secure.</li> <li>▪ Reset the monitor to factory settings.</li> <li>▪ Perform monitor self-test feature check to determine if the intermittent problem occurs in self-test mode.</li> </ul>
Missing Color	Picture missing color	<ul style="list-style-type: none"> <li>▪ Perform monitor self-test feature check.</li> <li>▪ Ensure that the video cable connecting the monitor to the computer is connected properly and is secure.</li> <li>▪ Check for bent or broken pins in the video cable connector.</li> </ul>
Wrong Color	Picture color not good	<ul style="list-style-type: none"> <li>▪ Change the settings of the <b>Preset Modes</b> in the <b>Game</b> menu OSD depending on the application.</li> <li>▪ Adjust R/G/B value under <b>Custom Color</b> in the <b>Game</b> menu OSD.</li> <li>▪ Run the built-in diagnostics.</li> </ul>
Image retention from a static image left on the monitor for a long period of time	Faint shadow from the static image displayed appears on the screen	<ul style="list-style-type: none"> <li>▪ Set the screen to turn off after a few minutes of screen idle time. These can be adjusted in Windows Power Options or Mac Energy Saver setting.</li> <li>▪ Alternatively, use a dynamically changing screensaver.</li> </ul>

## Product specific problems

Specific symptoms	What you experience	Possible solutions
Screen image is too small	Image is centered on screen, but does not fill entire viewing area	<ul style="list-style-type: none"><li>Reset the monitor to factory settings.</li></ul>
Cannot adjust the monitor with the buttons on the rear panel	OSD does not appear on the screen	<ul style="list-style-type: none"><li>Turn off the monitor, unplug the power cord, plug it back, and then turn on the monitor.</li></ul>
No Input Signal when user controls are pressed	No picture, the LED light is white	<ul style="list-style-type: none"><li>Check the signal source. Ensure the computer is not in the power saving mode by moving the mouse or pressing any key on the keyboard.</li><li>Check whether the signal cable is plugged in properly. Re-plug the signal cable if necessary.</li><li>Reset the computer or video player.</li></ul>
The picture does not fill the entire screen	The picture cannot fill the height or width of the screen	<ul style="list-style-type: none"><li>Due to different video formats (aspect ratio), the monitor may display in full screen.</li><li>Run the built-in diagnostics.</li></ul>
The displayed pictures appear incorrectly when the DP/HDMI cable is connected through a USB-C adapter or dock to your notebook/desktop	Display will freeze, has black screen or display abnormal screen	<ul style="list-style-type: none"><li>Do not use a USB-C adapter or dock. Connect the DP/HDMI cable directly to your notebook/desktop.</li></ul>

---

Screen flickering	There are some noticeable flickering in the displayed pictures	<ul style="list-style-type: none"><li>▪ Use the native resolution of your monitor (2560 x 1440 at 60 Hz) or higher refresh rate.</li><li>▪ If the variable refresh rate (VRR) of your device is turned on, turn off variable refresh rate (VRR).</li><li>▪ If you are using an Nvidia graphics card and G-Sync is turned on, turn off G-Sync.</li><li>▪ If you are using an AMD graphics card and Free-Sync is turned on, turn off Free-Sync.</li><li>▪ Update the graphics card driver and firmware to the latest version.</li><li>▪ Change the cable connecting the monitor to the system. A defective cable can cause the signal to break while being transmitted across the wire.</li><li>▪ Check the surroundings. Electromagnetic fields can cause screen flickering. If there is another device plugged into the same power strip as the monitor, try to remove it.</li></ul>
-------------------	--	--

---

## Universal Serial Bus (USB) specific problems

Specific symptoms	What you experience	Possible solutions
USB interface is not working	USB peripherals are not working	<ul style="list-style-type: none"><li>▪ Check that your monitor is turned on.</li><li>▪ Reconnect the upstream cable to your computer.</li><li>▪ Reconnect the USB peripherals (downstream connector).</li><li>▪ Switch off and then turn on the monitor again.</li><li>▪ Reboot the computer.</li><li>▪ Some USB devices like external portable HDD require higher electric current; connect the device directly to the computer system.</li></ul>
SuperSpeed USB 5 Gbps (USB 3.2 Gen1) interface is slow	SuperSpeed USB 5 Gbps (USB 3.2 Gen1) peripherals working slowly or not working at all	<ul style="list-style-type: none"><li>▪ Check that your computer is SuperSpeed USB 5 Gbps (USB 3.2 Gen1)-compatible.</li><li>▪ Some computers have USB 3.2, USB 2.0, and USB 1.1 ports. Ensure that the correct USB port is used.</li><li>▪ Reconnect the upstream cable to your computer.</li><li>▪ Reconnect the USB peripherals (downstream connector).</li><li>▪ Reboot the computer.</li></ul>
Wireless USB peripherals stop working when a USB 3.2 device is plugged in	Wireless USB peripherals responding slowly or only working as the distance between itself and its receiver decreases	<ul style="list-style-type: none"><li>▪ Increase the distance between the USB 3.2 peripherals and the wireless USB receiver.</li><li>▪ Position your wireless USB receiver as close as possible to the wireless USB peripherals.</li><li>▪ Use a USB-extender cable to position the wireless USB receiver as far away as possible from the USB 3.2 port.</li></ul>

# Appendix

## **WARNING: Safety instructions**

 **WARNING: Use of controls, adjustments, or procedures other than those specified in this documentation may result in exposure to shock, electrical hazards, and/or mechanical hazards.**

For information on safety instructions, see the Safety, Environmental, and Regulatory Information (SERI).

## **FCC notices (U.S. only) and other regulatory information**

For FCC notices and other regulatory information, see the regulatory compliance website located at [www.dell.com/regulatory\\_compliance](http://www.dell.com/regulatory_compliance).

## **Contact Dell**

For customers in the United States, call 800-WWW-DELL (800-999-3355).

 **NOTE: If you do not have an active Internet connection, you can find contact information on your purchase invoice, packing slip, bill, or Dell product catalog.**

**Dell provides several online and telephone-based support and service options. Availability varies by country and product, and some services may not be available in your area.**

- Online technical assistance: [www.dell.com/support/monitors](http://www.dell.com/support/monitors)
- Contacting Dell: [www.dell.com/contactdell](http://www.dell.com/contactdell)

## **EU product database for energy label and product information sheet**

AW2721D: <https://eprel.ec.europa.eu/qr/352625>