

AOC



**LCD Monitor
User Manual
U28G2XU
U28G2XU/BK**

| | |
|-------------------------------|----|
| Safety | 1 |
| National Conventions | 1 |
| Power | 2 |
| Installation | 3 |
| Cleaning | 4 |
| Other | 5 |
| Setup | 6 |
| Contents in Box | 6 |
| Setup Stand & Base | 7 |
| Adjusting Viewing Angle | 8 |
| Connecting the Monitor | 9 |
| Wall Mounting | 10 |
| Adjusting | 11 |
| Hotkeys | 11 |
| OSD Setting | 12 |
| Luminance | 13 |
| Color Setup | 14 |
| Picture Boost | 15 |
| OSD Setup | 16 |
| PIP Setting | 17 |
| Game Setting | 18 |
| Extra | 20 |
| Exit | 21 |
| LED Indicator | 22 |
| Troubleshoot | 23 |
| Specification | 24 |
| General Specification | 24 |
| Preset Display Modes | 25 |
| Pin Assignments | 26 |
| Plug and Play | 27 |

Safety

National Conventions

The following subsections describe notational conventions used in this document.

Notes, Cautions, and Warnings

Throughout this guide, blocks of text may be accompanied by an icon and printed in bold type or in italic type. These blocks are notes, cautions, and warnings, and they are used as follows:



NOTE: A NOTE indicates important information that helps you make better use of your computer system.



CAUTION: A CAUTION indicates either potential damage to hardware or loss of data and tells you how to avoid the problem.



WARNING: A WARNING indicates the potential for bodily harm and tells you how to avoid the problem. Some warnings may appear in alternate formats and may be unaccompanied by an icon. In such cases, the specific presentation of the warning is mandated by regulatory authority.

Power

 The monitor should be operated only from the type of power source indicated on the label. If you are not sure of the type of power supplied to your home, consult your dealer or local power company.

 The monitor is equipped with a three-pronged grounded plug, a plug with a third (grounding) pin. This plug will fit only into a grounded power outlet as a safety feature. If your outlet does not accommodate the three-wire plug, have an electrician install the correct outlet, or use an adapter to ground the appliance safely. Do not defeat the safety purpose of the grounded plug.

 Unplug the unit during a lightning storm or when it will not be used for long periods of time. This will protect the monitor from damage due to power surges.

 Do not overload power strips and extension cords. Overloading can result in fire or electric shock.

 To ensure satisfactory operation, use the monitor only with UL listed computers which have appropriate configured receptacles marked between 100-240V AC, Min. 5A.

 The wall socket shall be installed near the equipment and shall be easily accessible.

Installation

! Do not place the monitor on an unstable cart, stand, tripod, bracket, or table. If the monitor falls, it can injure a person and cause serious damage to this product. Use only a cart, stand, tripod, bracket, or table recommended by the manufacturer or sold with this product. Follow the manufacturer's instructions when installing the product and use mounting accessories recommended by the manufacturer. A product and cart combination should be moved with care.

! Never push any object into the slot on the monitor cabinet. It could damage circuit parts causing a fire or electric shock. Never spill liquids on the monitor.

! Do not place the front of the product on the floor.

! If you mount the monitor on a wall or shelf, use a mounting kit approved by the manufacturer and follow the kit instructions.

! Leave some space around the monitor as shown below. Otherwise, air-circulation may be inadequate hence overheating may cause a fire or damage to the monitor.

! To avoid potential damage, for example the panel peeling from the bezel, ensure that the monitor does not tilt downward by more than -5 degrees. If the -5 degree downward tilt angle maximum is exceeded, the monitor damage will not be covered under warranty.

See below the recommended ventilation areas around the monitor when the monitor is installed on the wall or on the stand:

Installed with stand



Cleaning

⚠ Clean the cabinet regularly with cloth. You can use soft-detergent to wipe out the stain, instead of strong-detergent which will cauterize the product cabinet.

⚠ When cleaning, make sure no detergent is leaked into the product. The cleaning cloth should not be too rough as it will scratch the screen surface.

⚠ Please disconnect the power cord before cleaning the product.



Other

 If the product is emitting a strange smell, sound or smoke, disconnect the power plug IMMEDIATELY and contact a Service Center.

 Make sure that the ventilating openings are not blocked by a table or curtain.

 Do not engage the LCD monitor in severe vibration or high impact conditions during operation.

 Do not knock or drop the monitor during operation or transportation.

 The power cords shall be safety approved. For Germany, it shall be H03VV-F, 3G, 0.75 mm², or better. For other countries, the suitable types shall be used accordingly.

 Excessive sound pressure from earphones and headphones can cause hearing loss. Adjustment of the equalizer to maximum increases the earphones and headphones output voltage and therefore the sound pressure level.

Setup

Contents in Box

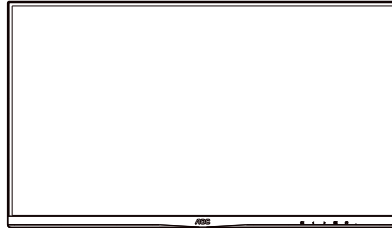

Monitor

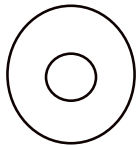

CD Manual



Warranty Card

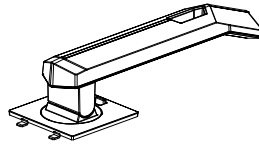

Stand

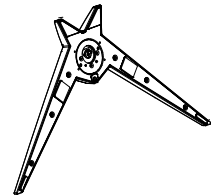

Base



Power Cable



DP Cable



HDMI Cable



Audio Cable



USB Cable

*Not all signal cables will be provided for all countries and regions. Please check with the local dealer or AOC branch office for confirmation.

Setup Stand & Base

Please setup or remove the base following the steps as below.

Setup:

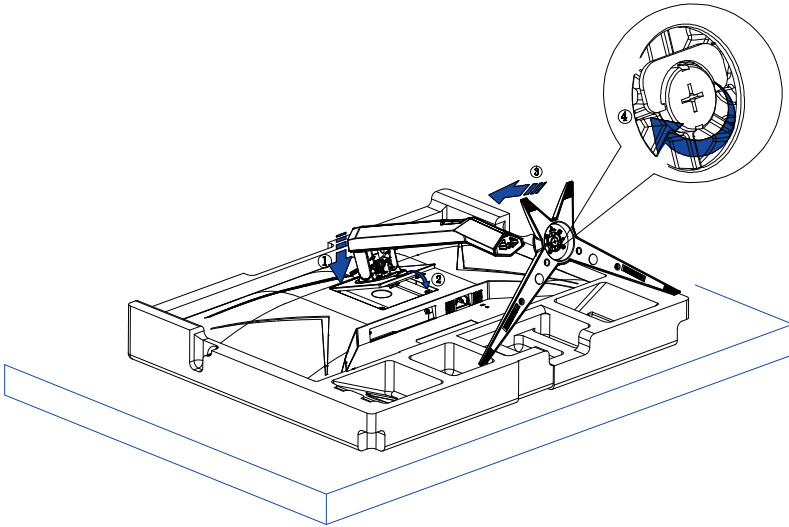

Remove:

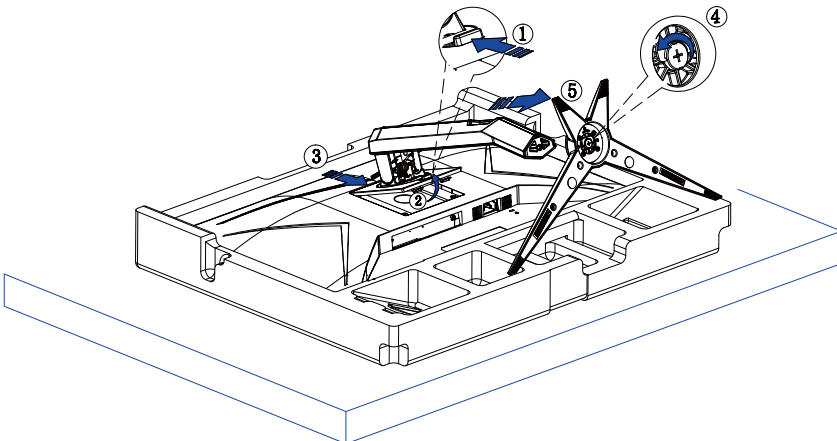

Adjusting Viewing Angle

For optimal viewing it is recommended to look at the full face of the monitor, then adjust the monitor's angle to your own preference.

Hold the stand so you will not topple the monitor when you change the monitor's angle.

You are able to adjust the monitor as below:

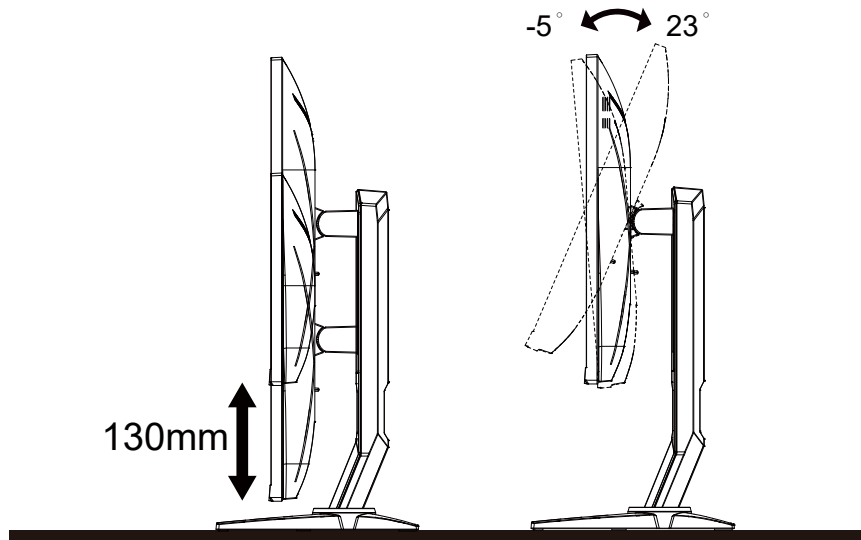

NOTE:

Do not touch the LCD screen when you change the angle. It may cause damage or break the LCD screen.

Warning:

1. To avoid potential screen damage, such as panel peeling, ensure that the monitor does not tilt downward by more than -5 degrees.
2. Do not press the screen while adjusting the angle of the monitor. Grasp only the bezel.

Connecting the Monitor

Cable Connections In Back of Monitor and Computer:

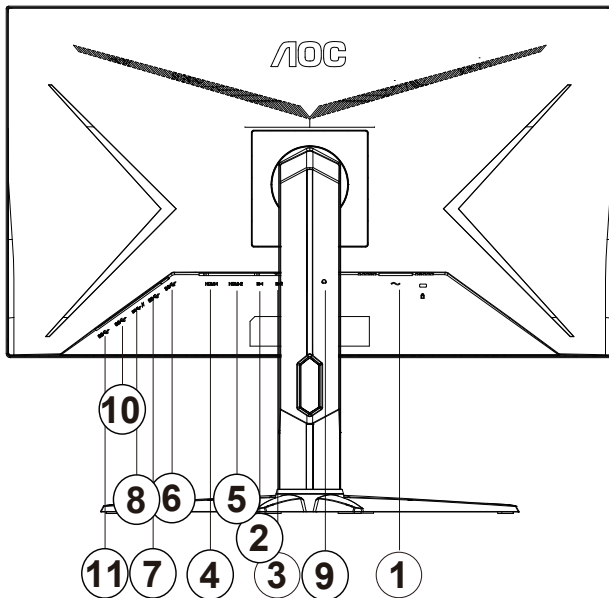

1. Power
2. DP-1
3. DP-2
4. HDMI-1
5. HDMI-2
6. USB-PC(USB upstream)
7. USB3.2 Gen1
8. USB3.2 Gen1+charging
9. Earphone
10. USB3.2 Gen1
11. USB3.2 Gen1

Connect to PC

1. Connect the power cord to the back of the display firmly.
2. Turn off your computer and unplug its power cable.
3. Connect the display signal cable to the video connector on the back of your computer.
4. Plug the power cord of your computer and your display into a nearby outlet.
5. Turn on your computer and display.

If your monitor displays an image, installation is complete. If it does not display an image, please refer Troubleshooting.

To protect equipment, always turn off the PC and LCD monitor before connecting.

Wall Mounting

Preparing to Install An Optional Wall Mounting Arm.

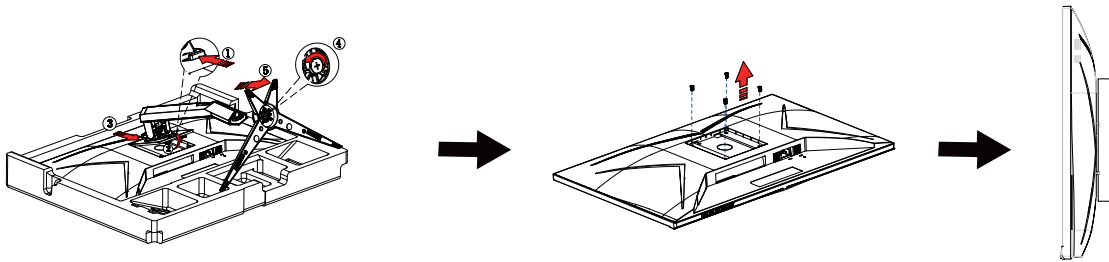

This monitor can be attached to a wall mounting arm you purchase separately. Disconnect power before this procedure. Follow these steps:

1. Remove the base.
2. Follow the manufacturer's instructions to assemble the wall mounting arm.
3. Place the wall mounting arm onto the back of the monitor. Line up the holes of the arm with the holes in the back of the monitor.
4. Reconnect the cables. Refer to the user's manual that came with the optional wall mounting arm for instructions on attaching it to the wall.

Noted: VESA mounting screw holes are not available for all models, please check with the dealer or official department of AOC.

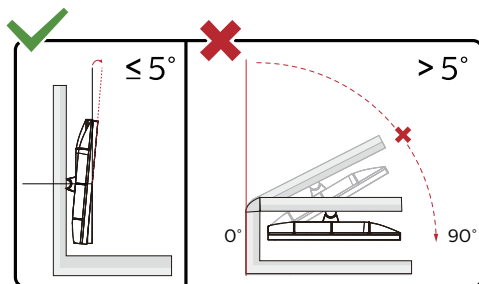

* Display design may differ from those illustrated.

Warning :

1. To avoid potential screen damage, such as panel peeling, ensure that the monitor does not tilt downward by more than -5 degrees.
2. Do not press the screen while adjusting the angle of the monitor. Grasp only the bezel.

Adjusting

Hotkeys

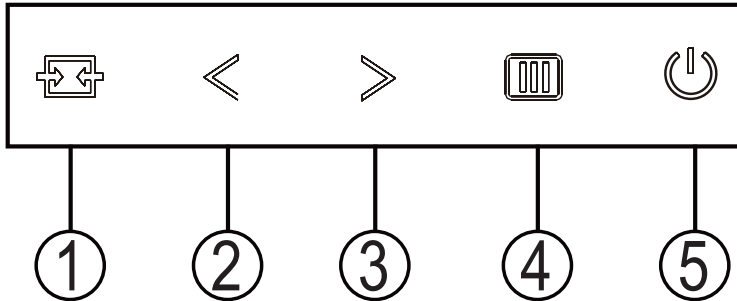

| | |
|---|--------------|
| 1 | Source/Exit |
| 2 | Game Mode/< |
| 3 | Dial Point/> |
| 4 | Menu/Enter |
| 5 | Power |

Power

Press the power key to turn on/off the monitor.

Menu/Select

Activate the OSD menu or function adjustment confirmation.

Game Mode/<

When there is no OSD, press "<" key to open game mode function, then press "<" or ">" key to select game mode (FPS, RTS, Racing, Gamer 1, Gamer 2 or Gamer 3) basing on the different game types.

Dial Point/>

When there is no OSD, press Dial Point button to show / hide Dial Point.

Source/exit

When the OSD menu is off, press this key to activate the signal source switching function, press this key continuously to select the signal source displayed in the information bar, and press the menu key to adjust to the selected signal source. When the OSD menu is active, this button acts as an exit key (to exit the OSD menu)

OSD Setting

Basic and simple instruction on the control keys.

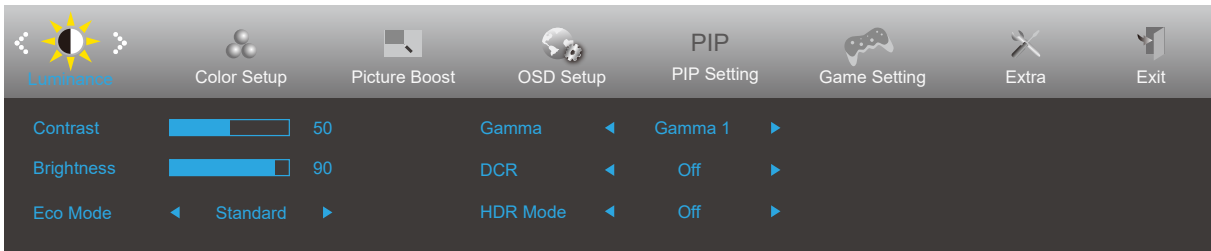









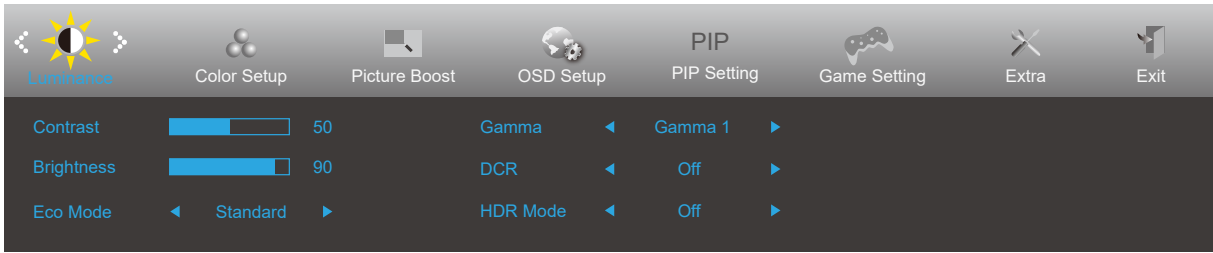

- 1). Press the **MENU-button** to activate the OSD window.
- 2). Press < or > to navigate through the functions. Once the desired function is highlighted, press the **MENU-button** to activate it, press < or > to navigate through the sub-menu functions. Once the desired function is highlighted, press **MENU-button** to activate it.
- 3). Press < or > to change the settings of the selected function. Press **AUTO-button** to exit. If you want to adjust any other function, repeat steps 2-3.
- 4). OSD Lock Function: To lock the OSD, press and hold the **MENU-button** while the monitor is off and then press **power button** to turn the monitor on. To un-lock the OSD - press and hold the **MENU-button** while the monitor is off and then press **power button** to turn the monitor on.

Notes:

- 1). If the product has only one signal input, the item of "Input Select" is disable to adjust.
- 2). If the screen size of the product is 4:3 or the input signal resolution is the native resolution, then the item "Image Ratio" is invalid.
- 3). The four states of ECO mode (except standard mode), DCR, DCB mode and window highlight can only display one state at a time.

Luminance





| | | | | |
|---|---|------------|---|---------------------------------|
|  | Contrast | 0-100 | | Contrast from Digital-register. |
| | Brightness | 0-100 | | Backlight Adjustment |
| | Eco mode | Standard | <input checked="" type="checkbox"/> | Standard Mode |
| | | Text |  | Text Mode |
| | | Internet |  | Internet Mode |
| | | Game |  | Game Mode |
| | | Movie |  | Movie Mode |
| | | Sports |  | Sports Mode |
| | | Reading |  | Reading Mode |
| | | Uniformity |  | Uniformity Mode |
| | Gamma | Gamma1 | Adjust to Gamma 1 | |
| | | Gamma2 | Adjust to Gamma 2 | |
| | | Gamma3 | Adjust to Gamma 3 | |
| | DCR | Off | | Disable dynamic contrast ratio |
| | | On |  | Enable dynamic contrast ratio |
| HDR | Off / DisplayHDR / HDR Picture / HDR Movie / HDR Game | | Disable or Enable HDR | |
| HDR Mode | Off / HDR Picture / HDR Movie / HDR Game | | Disable or Enable HDR Mode | |

Note:

When HDR is detected, the HDR option is displayed for adjustment; when HDR is not detected, the HDR Mode option is displayed for adjustment.

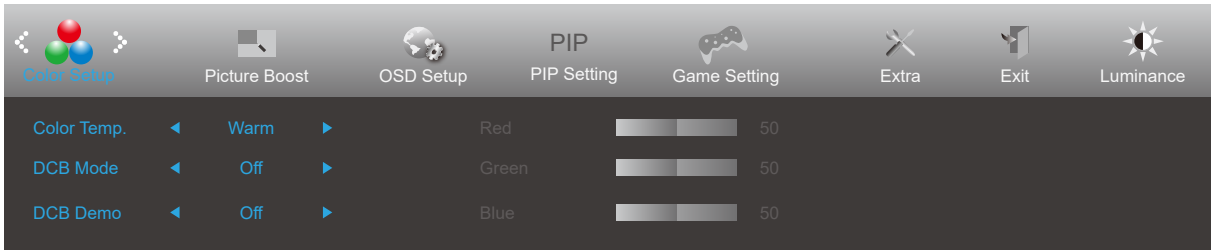
Color Setup





| | | | | |
|---|-------------|--------------|-----------------------------------|--|
|  | Color Temp. | Warm | | Recall Warm Color Temperature from EEPROM. |
| | | Normal | | Recall Normal Color Temperature from EEPROM. |
| | | Cool | | Recall Cool Color Temperature from EEPROM. |
| | | sRGB | | Recall SRGB Color Temperature from EEPROM. |
| | User | Red | | Red Gain from Digital-register |
| | | Green | | Green Gain Digital-register. |
| | | Blue | | Blue Gain from Digital-register |
| | DCB Mode | Full Enhance | on or off | Disable or Enable Full Enhance Mode |
| | | Nature Skin | on or off | Disable or Enable Nature Skin Mode |
| | | Green Field | on or off | Disable or Enable Green Field Mode |
| | | Sky-blue | on or off | Disable or Enable Sky-blue Mode |
| | | Auto Detect | on or off | Disable or Enable AutoDetect Mode |
| | | OFF | on or off | Disable or Enable DCB Mode |
| | DCB Demo | | on or off | Disable or Enable Demo |
| Red | | 0-100 | Red gain from Digital-register. | |
| Green | | 0-100 | Green gain from Digital-register. | |
| Blue | | 0-100 | Blue gain from Digital-register. | |

Note:

When "HDR Mode" under "Luminance" is set to a non-off state, all items under "Color Setup" cannot be adjusted.

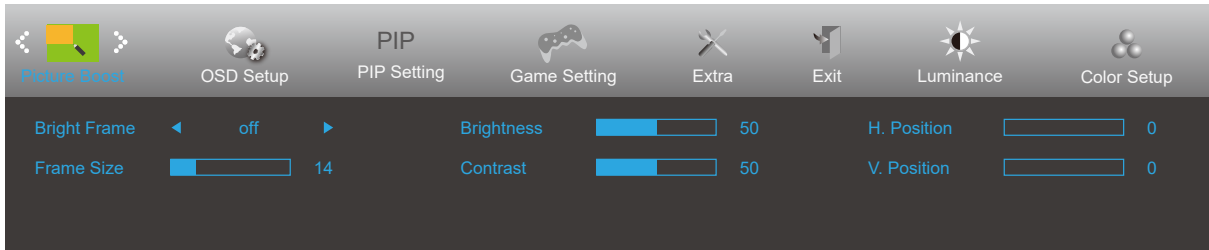
Picture Boost





| | | | |
|---|--------------|-----------|----------------------------------|
|  | Bright Frame | on or off | Disable or Enable Bright Frame |
| | Frame Size | 14-100 | Adjust Frame Size |
| | Brightness | 0-100 | Adjust Frame Brightness |
| | Contrast | 0-100 | Adjust Frame Contrast |
| | H. position | 0-100 | Adjust Frame horizontal Position |
| | V. position | 0-100 | Adjust Frame vertical Position |

Note:

- 1). For a better viewing experience, adjust the brightness, contrast, and position of the brightening.
- 2). When the „HDR Mode“ under „Luminance“ is set to a non-off state, all items under „Picture Boost“ cannot be adjusted.

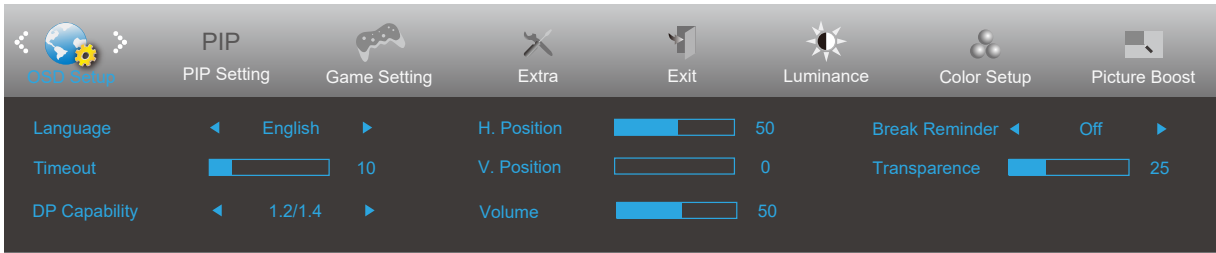
OSD Setup



| | | | |
|---|----------------|-------------|---|
|  | Language | | Select the OSD language |
| | Timeout | 5-120 | Adjust the OSD Timeout |
| | DP Capability | 1.1/1.2/1.4 | If the DP video content supports DP1.2/1.4, please select DP1.2/1.4 for DP Capability; otherwise, please select DP1.1 |
| | H. Position | 0-100 | Adjust the horizontal position of OSD |
| | V. Position | 0-100 | Adjust the vertical position of OSD |
| | Volume | 0-100 | Volume Adjustment. |
| | Transparence | 0-100 | Adjust the transparence of OSD |
| | Break Reminder | on or off | Break reminder if the user continuously work for more than 1hrs |

PIP Setting

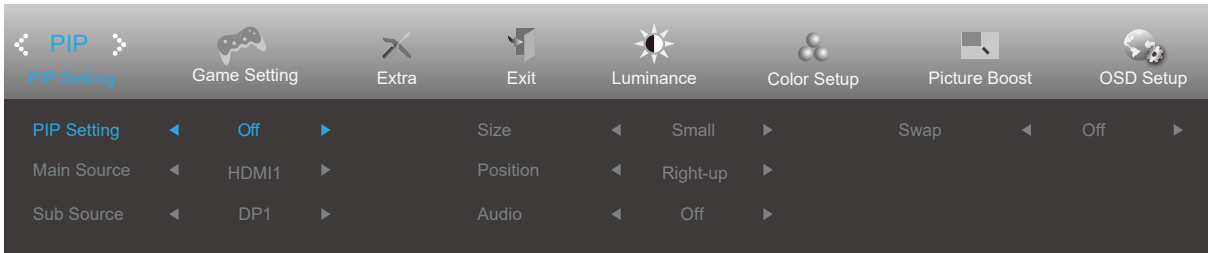

| | | | |
|------|-----------------|--------------------------|--------------------------------|
| PIP | PIP Setting | OFF / PIP / PBP | Disable or Enable PIP or PBP. |
| | Main Source | HDMI1 、 HDMI2 、 DP1、 DP2 | Select main screen source. |
| | Sub Source | HDMI1 、 HDMI2 、 DP1、 DP2 | Select sub screen source. |
| | Size | Small / Middle / Large | Select screen size. |
| | Position | Right-up | Set the screen location. |
| | | Right-down | |
| | | Left-up | |
| | | Left-down | |
| | Audio | On: PIP Audio | Disable or Enable Audio Setup. |
| | | Off: Main Audio | |
| Swap | On: Swap | Swap the screen source. | |
| | Off: non action | | |

Game Setting

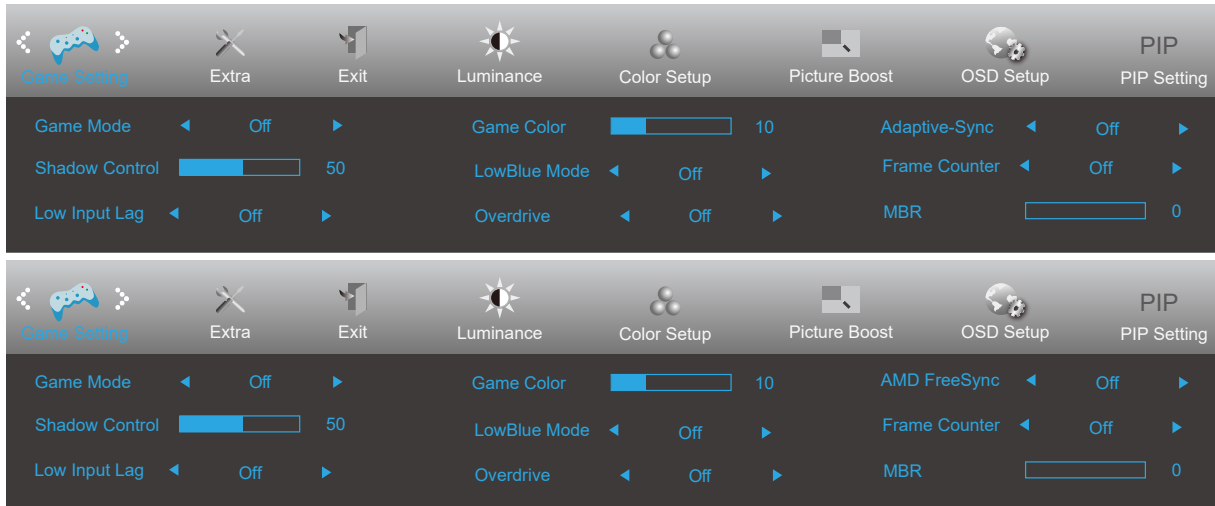

| | | | |
|---|---|--|--|
|  | Game Mode | FPS | For playing FPS (first Person Shooters) games. Improves dark theme black level details. |
| | | RTS | For playing RTS (Real Time Strategy). Improves the image quality. |
| | | Racing | For playing Racing games, Provides fastest response time and high color saturation. |
| | | Gamer 1 | User's preference settings saved as Gamer 1. |
| | | Gamer 2 | User's preference settings saved as Gamer 2. |
| | | Gamer 3 | User's preference settings saved as Gamer 3. |
| | | off | No optimization by Smart image game |
| | Shadow Control | 0-100 | Shadow Control Default is 50, then end-user can adjust from 50 to 100 or 0 to increase contrast for clear picture. 1. If picture is too dark to be saw the detail clearly, adjusting from 50 to100 for clear picture. 2. If picture is too white to be saw the detail clearly, adjusting from 50 to0 for clear picture |
| | Low Input Lag | On/Off | Turn off frame buffer to decrease input lag |
| | Game Color | 0-20 | Game Color will provide 0-20 level for adjusting saturation to get better picture. |
| | LowBlue Mode | Reading / Office / Internet / Multimedia / Off | Decrease blue light wave by controlling color temperature. |
| | Overdrive | Off | Adjust the response time. |
| | | Weak | |
| | | Medium | |
| Strong | | | |
| Boost | | | |
| Adaptive-Sync/AMD FreeSync (Available for selective models) | On/Off | Adjust the Adaptive-Sync/AMD FreeSync. | |
| Frame Counter | Off / Right-up / Right-Down / Left-Down / Left-Up | Display V frequency on the corner selected | |
| MBR | 0 ~ 20 | Adjust the Motion Blur Reduction. | |

Note:

1. When the “HDR Mode” under “Luminance” is set to a non-off state, the “Game Mode”, “Shadow Control、 Game Color”

items under “Game Setting” cannot be adjusted.

2. The function MBR and Overdrive Boost are available only when Adaptive-Sync/AMD FreeSync is off.

3. When MBR or Overdrive Boost is ON, the overall brightness will be darker than normal.

4. The function MBR or Overdrive Boost may cause abnormal display (image flicker, fuzzy and ghosting etc..).

5. The function MBR or Overdrive Boost are gaming-optimized mode. It is recommended to turn off when you are not using gaming function.

Extra

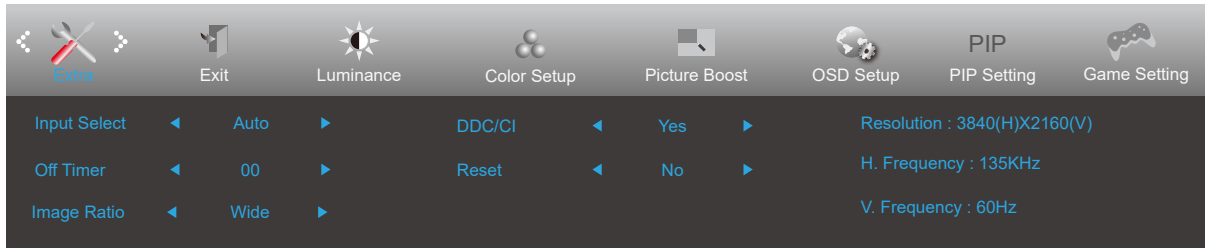

| | | | |
|--|--------------------|--|---------------------------------|
|  | Input Select | | Select Input Signal Source |
| | Off timer | 0-24hrs | Select DC off time |
| | Image Ratio | Wide | Select image ratio for display. |
| | | 4:3 | |
| | | 1:1 | |
| | | 17" (4:3) | |
| | | 19" (4:3) | |
| | | 19" (5:4) | |
| | | 19"W (16:10) | |
| | | 21.5"W (16:9) | |
| | | 22"W (16:10) | |
| | | 23"W (16:9) | |
| 23.6"W (16:9) | | | |
| 24"W (16:9) | | | |
| 27"W (16:9) | | | |
| DDC/CI | yes or no | Turn ON/OFF DDC/CI Support | |
| Reset | yes or no | Reset the menu to default. (ENERGY STAR® available for selective models.) | |
| | ENERGY STAR® or no | | |

Exit

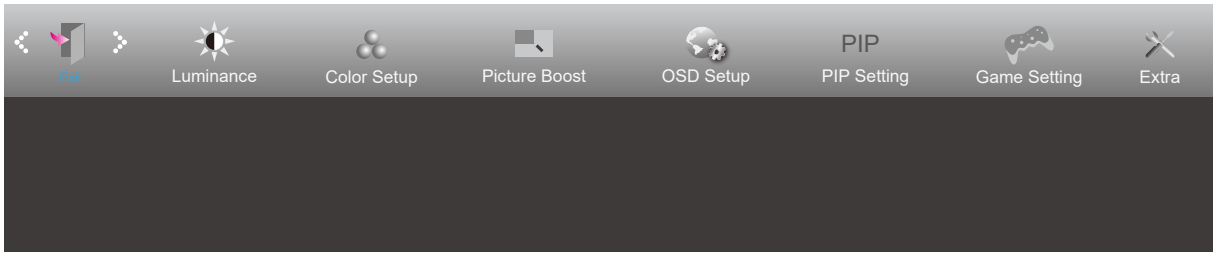

| | | | |
|---|------|--|-------------------|
|  | Exit | | Exit the main OSD |
|---|------|--|-------------------|

LED Indicator

| Status | LED Color |
|-----------------|-----------|
| Full Power Mode | White |
| Active-off Mode | Orange |

Troubleshoot

| Problem & Question | Possible Solutions |
|---|---|
| Power LED Is Not ON | Make sure the power button is ON and the Power Cord is properly connected to a grounded power outlet and to the monitor. |
| No images on the screen | <ul style="list-style-type: none"> • Is the power cord connected properly? Check the power cord connection and power supply. • Is the cable connected correctly? (Connected using the VGA cable) Check the VGA cable connection. (Connected using the HDMI cable) Check the HDMI cable connection. (Connected using the DP cable) Check the DP cable connection. * VGA/HDMI/DP input is not available on every model. • If the power is on, reboot the computer to see the initial screen (the login screen), which can be seen. If the initial screen (the login screen) appears, boot the computer in the applicable mode (the safe mode for Windows 7/8/10) and then change the frequency of the video card. (Refer to the Setting the Optimal Resolution) If the initial screen (the login screen) does not appear, contact the Service Center or your dealer. • Can you see "Input Not Supported" on the screen? You can see this message when the signal from the video card exceeds the maximum resolution and frequency that the monitor can handle properly. Adjust the maximum resolution and frequency that the monitor can handle properly. • Make sure the AOC Monitor Drivers are installed. |
| Picture Is Fuzzy & Has Ghosting Shadowing Problem | Adjust the Contrast and Brightness Controls. Press to auto adjust. Make sure you are not using an extension cable or switch box. We recommend plugging the monitor directly to the video card output connector on the back. |
| Picture Bounces, Flickers Or Wave Pattern Appears In The Picture | Move electrical devices that may cause electrical interference as far away from the monitor as possible. Use the maximum refresh rate your monitor is capable of at the resolution you are using. |
| Monitor Is Stuck In Active Off-Mode" | The Computer Power Switch should be in the ON position. The Computer Video Card should be snugly fitted in its slot. Make sure the monitor's video cable is properly connected to the computer. Inspect the monitor's video cable and make sure no pin is bent. Make sure your computer is operational by hitting the CAPS LOCK key on the keyboard while observing the CAPS LOCK LED. The LED should either turn ON or OFF after hitting the CAPS LOCK key. |
| Missing one of the primary colors (RED, GREEN, or BLUE) | Inspect the monitor's video cable and make sure that no pin is damaged. Make sure the monitor's video cable is properly connected to the computer. |
| Screen image is not centered or sized properly | Adjust H-Position and V-Position or press hot-key (AUTO). |
| Picture has color defects (white does not look white) | Adjust RGB color or select desired color temperature. |
| Horizontal or vertical disturbances on the screen | Use Windows 7/8/10 shut-down mode to adjust CLOCK and FOCUS. Press to auto-adjust. |
| Regulation & Service | Please refer to Regulation & Service Information which is in the CD manual or www.aoc.com (to find the model you purchase in your country and to find Regulation & Service Information in Support page. |

Specification

General Specification

| | | | | |
|--------------------------|-------------------------------|---|----------------------------|--|
| Panel | Model name | U28G2XU U28G2XU/BK | | |
| | Driving system | TFT Color LCD | | |
| | Viewable Image Size | 70.9 cm diagonal | | |
| | Pixel pitch | 0.16mm(H) x 0.16mm(V) | | |
| Others | Horizontal scan range | 30k-255kHz | | |
| | Horizontal scan Size(Maximum) | 620.93mm | | |
| | Vertical scan range | 48-120Hz (HDMI) 48-144Hz (DP) | | |
| | Vertical Scan Size(Maximum) | 341.28mm | | |
| | Optimal preset resolution | 3840x2160@60Hz | | |
| | Max resolution | 3840x2160@60Hz (HDMI) 3840x2160@144Hz (DP) | | |
| | Plug & Play | VESA DDC2B/CI | | |
| | Power Source | 100-240V~, 50/60Hz, 1.5A | | |
| | Power Consumption | Typical(Default brightness and contrast) | 45W | |
| | | Max. (brightness = 100, contrast =100) | ≤ 120W | |
| Standby mode | | ≤ 0.5W | | |
| Physical Characteristics | Connector Type | HDMI×2、 DP×2、 USB、 Earphone | | |
| | Signal Cable Type | Detachable | | |
| Environmental | Temperature | Operating | 0°~ 40° | |
| | | Non-Operating | -25°~ 55° | |
| | Humidity | Operating | 10% ~ 85% (non-condensing) | |
| | | Non-Operating | 5% ~ 93% (non-condensing) | |
| | Altitude | Operating | 0~ 5000 m (0~ 16404ft) | |
| | | Non-Operating | 0~ 12192m (0~ 40000ft) | |

U28G2XU/BK



Preset Display Modes

| STANDARD | RESOLUTION | HORIZONTAL FREQUENCY(kHz) | VERTICAL FREQUENCY(Hz) |
|----------------|-----------------|---------------------------|------------------------|
| VGA | 640x480@60Hz | 31.469 | 59.94 |
| VGA | 640x480@67Hz | 35 | 66.667 |
| VGA | 640x480@72Hz | 37.861 | 72.809 |
| VGA | 640x480@75Hz | 37.5 | 75 |
| DOS MODE | 720x400@70Hz | 31.469 | 70.087 |
| SVGA | 800x600@56Hz | 35.156 | 56.25 |
| SVGA | 800x600@60Hz | 37.879 | 60.317 |
| SVGA | 800x600@72Hz | 48.077 | 72.188 |
| SVGA | 800x600@75Hz | 46.875 | 75 |
| MAC MODE | 832x624@75Hz | 49.725 | 74.551 |
| XGA | 1024x768@60Hz | 48.363 | 60.004 |
| XGA | 1024x768@70Hz | 56.476 | 70.069 |
| XGA | 1024x768@75Hz | 60.023 | 75.029 |
| HD | 1280x960@60Hz | 60 | 60 |
| HD | 1280x720@60Hz | 44.772 | 59.885 |
| SXGA | 1280x1024@60Hz | 63.981 | 60.02 |
| SXGA | 1280x1024@75Hz | 79.976 | 75.025 |
| WXGA+ | 1440x900@60Hz | 55.935 | 59.887 |
| WSXGA | 1680x1050@60Hz | 64.674 | 59.954 |
| FHD | 1920x1080@60Hz | 67.5 | 60 |
| *** | 1920x2160@60Hz | 133.293 | 59.988 |
| QHD (for DP) | 2560x1440@144Hz | 222.056 | 143.912 |
| QHD | 2560x1440@120Hz | 182.996 | 119.998 |
| UHD (for HDMI) | 3840x2160@30Hz | 67.5 | 30 |
| UHD | 3840x2160@60Hz | 133.32 | 60 |
| UHD (for DP) | 3840x2160@75Hz | 166.652 | 75.001 |
| UHD (for DP) | 3840x2160@85Hz | 188.87 | 85 |
| UHD (for DP) | 3840x2160@100Hz | 222.202 | 100.001 |
| UHD (for DP) | 3840x2160@120Hz | 266.653 | 120.006 |
| UHD (for DP) | 3840x2160@144Hz | 319.944 | 143.989 |

Pin Assignments



19-Pin Color Display Signal Cable

| Pin No. | Signal Name | Pin No. | Signal Name | Pin No. | Signal Name |
|---------|--------------------|---------|---------------------------|---------|-----------------|
| 1. | TMDS Data 2+ | 9. | TMDS Data 0- | 17. | DDC/CEC Ground |
| 2. | TMDS Data 2 Shield | 10. | TMDS Clock + | 18. | +5V Power |
| 3. | TMDS Data 2- | 11. | TMDS Clock Shield | 19. | Hot Plug Detect |
| 4. | TMDS Data 1+ | 12. | TMDS Clock- | | |
| 5. | TMDS Data 1Shield | 13. | CEC | | |
| 6. | TMDS Data 1- | 14. | Reserved (N.C. on device) | | |
| 7. | TMDS Data 0+ | 15. | SCL | | |
| 8. | TMDS Data 0 Shield | 16. | SDA | | |

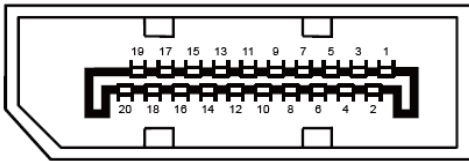

20-Pin Color Display Signal Cable

| Pin No. | Signal Name | Pin No. | Signal Name |
|---------|---------------|---------|-----------------|
| 1 | ML_Lane 3 (n) | 11 | GND |
| 2 | GND | 12 | ML_Lane 0 (p) |
| 3 | ML_Lane 3 (p) | 13 | CONFIG1 |
| 4 | ML_Lane 2 (n) | 14 | CONFIG2 |
| 5 | GND | 15 | AUX_CH(p) |
| 6 | ML_Lane 2 (p) | 16 | GND |
| 7 | ML_Lane 1 (n) | 17 | AUX_CH(n) |
| 8 | GND | 18 | Hot Plug Detect |
| 9 | ML_Lane 1 (p) | 19 | Return DP_PWR |
| 10 | ML_Lane 0 (n) | 20 | DP_PWR |

Plug and Play

Plug & Play DDC2B Feature

This monitor is equipped with VESA DDC2B capabilities according to the VESA DDC STANDARD. It allows the monitor to inform the host system of its identity and, depending on the level of DDC used, communicate additional information about its display capabilities.

The DDC2B is a bi-directional data channel based on the I2C protocol. The host can request EDID information over the DDC2B channel.