

USER MANUAL

ProLite

LCD Monitor

ENGLISH

ProLite XUB2495WSU
ProLite XU2495WSU

Thank you very much for choosing the iiyama LCD monitor.

We recommend that you take a few minutes to read carefully through this brief but comprehensive manual before installing and switching on the monitor. Please keep this manual in a safe place for your future reference.



Dear user, we congratulate you on the purchase of your iiyama LCD.

For details on warranty and locally used pixel policies that apply directly after installation of your product please check the iiyama website.

To report a fault, please contact your local support centre found at www.iiyama.com/service

Things to check before you call the iiyama information line

- | if the power cable is connected securely and turned on?
- | if the display has been turned on?
- | if the signal cable is connected securely and the correct input selected?
- | if the computer has been restarted with the display connected?
- | if the graphics card is correctly installed with the latest drivers possible?
- | if the correct native resolution has been selected via 'Display Properties'?
- | If the R/G/B signal configuration is correct?
- | if the displays On Screen Menu is shown?
- | if the correct brightness and contrast settings have been set?
- | if given display tolerances and compatibility have been considered?
- | if via the On Screen Menu you have performed a Factory Reset/Recall?

Before reporting the screen defect, please prepare the following information/evidence:

- | model number *
- | purchase receipt and serial number *
- | name and address for collection
- | telephone/fax number, for availability during the day
- | convenient collection date (date, time)
- | short description of the defect

Important Note:

If there is no fault found in the collected equipment after inspection, the transferring party shall incur charges for transport and administration.

If you have checked all of the above and there is still no picture, call our information line for assistance in your country.

* see the identification plate on the back of the case.

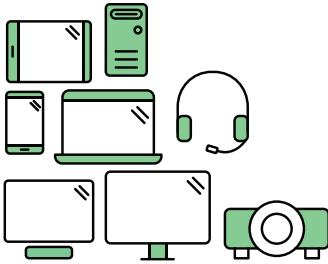

Say hello to a more sustainable product

IT products are associated with a wide range of sustainability risks throughout their life cycle. Human rights violations are common in the factories. Harmful substances are used both in products and their manufacture. Products can often have a short lifespan because of poor ergonomics, low quality and when they are not able to be repaired or upgraded.

This product is a better choice. It meets all the criteria in TCO Certified, the world's most comprehensive sustainability certification for IT products. Thank you for making a responsible product choice, that help drive progress towards a more sustainable future!

Criteria in TCO Certified have a life-cycle perspective and balance environmental and social responsibility. Conformity is verified by independent and approved verifiers that specialize in IT products, social responsibility or other sustainability issues. Verification is done both before and after the certificate is issued, covering the entire validity period. The process also includes ensuring that corrective actions are implemented in all cases of factory non-conformities. And last but not least, to make sure that the certification and independent verification is accurate, both TCO Certified and the verifiers are reviewed regularly.

Want to know more?

Read information about TCO Certified, full criteria documents, news and updates at [tcocertified.com](https://www.tcocertified.com). On the website you'll also find our Product Finder, which presents a complete, searchable listing of certified products.

CE MARKING DECLARATION OF CONFORMITY

This LCD monitor complies with the requirements of the EC/EU Directive 2014/30/EU "EMC Directive", 2014/35/EU "Low Voltage Directive", 2009/125/EC "ErP Directive" and 2011/65/EU "RoHS Directive".

The electro-magnetic susceptibility has been chosen at a level that gives correct operation in residential areas, business and light industrial premises and small-scale enterprises, inside as well as outside of the buildings. All places of operation are characterised by their connection to the public low voltage power supply system.

IYAMA CORPORATION: Wijkemeerstraat 8, 2131 HA Hoofddorp, The Netherlands

Model No. : PL2495W

An approved power cord greater or equal to H05VVF, 3G, 0.75mm² must be used.



We recommend recycling of used product. Please contact your dealer or iiyama service center. Recycle information is obtained via the Internet, using the address:
<http://www.iiyama.com>

You can access the Web page of different countries from there.

- We reserve the right to change specifications without notice.
- All trademarks used in this user manual are the property of their respective owners.
- As an ENERGY STAR® Partner, iiyama has determined that this product meets the ENERGY STAR® guidelines for energy efficiency.
- This product qualifies for ENERGY STAR® in the "factory default" setting and this is the setting in which power saving will be achieved. Changing the factory default picture settings or enabling other features will increase power consumption that could exceed the limits necessary to qualify for ENERGY STAR® rating.
- Eprel registration number ProLite XUB2495WSU-B3 : 371088, ProLite XU2495WSU-B3 : 371095

TABLE OF CONTENTS

FOR YOUR SAFETY.....	1
SAFETY PRECAUTIONS.....	1
SPECIAL NOTES ON LCD MONITORS	3
CUSTOMER SERVICE	3
CLEANING	3
BEFORE YOU OPERATE THE MONITOR	4
FEATURES.....	4
CHECKING THE CONTENTS OF THE PACKAGE	4
INSTALLATION	5
FITTING AND REMOVAL OF BASE : ProLite XUB2495WSU	7
FITTING AND REMOVAL OF BASE : ProLite XU2495WSU	8
CONTROLS AND CONNECTORS : ProLite XUB2495WSU	9
CONTROLS AND CONNECTORS : ProLite XU2495WSU.....	10
CONNECTING YOUR MONITOR : ProLite XUB2495WSU.....	11
CONNECTING YOUR MONITOR : ProLite XU2495WSU	12
DISCONNECTING YOUR MONITOR.....	13
COMPUTER SETTING	14
ADJUSTING THE VIEWING ANGLE : ProLite XU2495WSU.....	14
ADJUSTING THE HEIGHT AND THE VIEWING ANGLE :	
ProLite XUB2495WSU	15
OPERATING THE MONITOR.....	16
ADJUSTMENT MENU CONTENTS.....	17
SCREEN ADJUSTMENTS	27
STANDBY FEATURE	30
TROUBLE SHOOTING	31
RECYCLING INFORMATION.....	32
APPENDIX	33
SPECIFICATIONS : ProLite XUB2495WSU.....	33
SPECIFICATIONS : ProLite XU2495WSU	34
DIMENSIONS : ProLite XUB2495WSU	35
DIMENSIONS : ProLite XU2495WSU	35
COMPLIANT TIMING	36

FOR YOUR SAFETY

SAFETY PRECAUTIONS

WARNING

STOP OPERATING THE MONITOR IF YOU ARE AWARE OF ANY PROBLEMS

If you notice any abnormal phenomena such as smoke, strange sounds or fumes, unplug the monitor and contact your dealer or iiyama service center immediately. Further use may be dangerous and can cause fire or electric shock.

NEVER REMOVE THE CABINET

High voltage circuits are inside the monitor. Removing the cabinet may expose you to the danger of fire or electric shock.

DO NOT PUT ANY OBJECT INTO THE MONITOR

Do not put any solid objects or liquids such as water into the monitor. In case of an accident, unplug your monitor immediately and contact your dealer or iiyama service center. Using the monitor with any object inside may cause fire, electric shock or damage.

INSTALL THE MONITOR ON A FLAT, STABLE SURFACE

The monitor may cause an injury if it falls or is dropped.

DO NOT USE THE MONITOR NEAR WATER

Do not use where water may be splashed or spilt onto the monitor as it may cause fire or electric shock.

OPERATE UNDER THE SPECIFIED POWER SUPPLY

Be sure to operate the monitor only with the specified power supply. Use of an incorrect voltage will cause malfunction and may cause fire or electric shock.

PROTECT THE CABLES

Do not pull or bend the power cable and signal cable. Do not place the monitor or any other heavy objects on the cables. If damaged, the cables may cause fire or electric shock.

ADVERSE WEATHER CONDITIONS

It is advisable not to operate the monitor during a heavy thunder storm as the continual breaks in power may cause malfunction. It is also advised not to touch the plug in these circumstances as it may cause electric shock.

CAUTION

INSTALLATION LOCATION

Do not install the monitor where sudden temperature changes may occur, or in humid, dusty or smoky areas as it may cause fire, electric shock or damage. You should also avoid areas where the sun shines directly on the monitor.

DO NOT PLACE THE MONITOR IN A HAZARDOUS POSITION

The monitor may topple and cause injury if not suitably located. Please also ensure that you do not place any heavy objects on the monitor, and that all cables are routed such that children may not pull the cables and possibly cause injury.

MAINTAIN GOOD VENTILATION

Ventilation slots are provided to keep the monitor from overheating. Covering the slots may cause fire. To allow adequate air circulation, place the monitor at least 10cm (or 4 inches) from any walls.

When removing the tilt stand, the ventilation slots on the back side of the monitor can be blocked. This may overheat the monitor and may cause fire or damage. Make sure to allow enough ventilation when removing the tilt stand. Operating the monitor on its back, side, upside down or on a carpet or any other soft material may also cause damage.

DISCONNECT THE CABLES WHEN YOU MOVE THE MONITOR

When you move the monitor, turn off the power switch, unplug the monitor and be sure the signal cable is disconnected. If you do not disconnect them, it may cause fire or electric shock.

UNPLUG THE MONITOR

If the monitor is not in use for a long period of time it is recommended that it is left unplugged to avoid accidents.

HOLD THE PLUG WHEN DISCONNECTING

To disconnect the power cable or signal cable, always pull it by the plug. Never pull on the cable itself as this may cause fire or electric shock.

DO NOT TOUCH THE PLUG WITH WET HANDS

Pulling or inserting the plug with wet hands may cause electric shock.

WHEN YOU INSTALL THE MONITOR ON YOUR COMPUTER

Be sure the computer is strong enough to hold the weight of the monitor, otherwise, you may damage your computer.

CAREFUL! PROTECT YOUR HANDS AND FINGERS

- Be careful not to hurt your fingers or hands when you change the height or the angle.
- Injury can occur if care is not taken to avoid finger contact with the displays base when adjusting the height. (Just for height adjustable model.)

REMARK FOR 24/7 USAGE

This product is not specifically designed for 24/7 usage in all environments.

REMARK FOR WALL MOUNTING

This product is not designed for digital signage (electronic signboard) applications such as wall mounting.

OTHERS

ERGONOMIC RECOMMENDATIONS

To eliminate eye fatigue, do not operate the monitor against a bright background or in a dark room. For optimal viewing comfort, the monitor should be just below eye level and 40-60 cm (16-24 inches) away from your eyes. When using the monitor over a prolonged time, a ten minute break every hour is recommended as looking at the screen continuously can cause eye strain.

SPECIAL NOTES ON LCD MONITORS

The following symptoms are normal with LCD monitors and do not indicate a problem.

- NOTE**
- When you first turn on the LCD monitor, the picture may not fit in the display area because of the type of computer that is used. In this case, adjust the picture position to the correct position.
 - You may find slightly uneven brightness on the screen depending on the desktop pattern you use.
 - Due to the nature of the LCD screen, an afterimage of the previous screen may remain after switching the image, when the same image is displayed for hours. In this case, the screen can be recovered slowly by changing the image or turning off the Power Switch for some hours.

CUSTOMER SERVICE

- NOTE**
- If you have to return your unit for service and the original packaging has been discarded, please contact your dealer or iiyama service center for advice or replacement packaging.

CLEANING

- WARNING**
- If you drop any materials or liquids such as water into the monitor when cleaning, unplug the power cable immediately and contact your dealer or iiyama service center.

- CAUTION**
- For safety reasons, turn off the power switch and unplug the monitor before you clean it.

- NOTE**
- To protect the LCD panel, do not scratch or rub the screen with a hard object.
 - Never use any of the following strong solvents. These will damage the cabinet and the LCD screen.

Thinner	Spray-type cleaner
Benzine	Wax
Abrasive cleaner	Acid or Alkaline solvent

- Touching the cabinet with any product made from rubber or plastic for a long time may cause degeneration or loss of paint on the cabinet.

CABINET Stains can be removed with a cloth lightly moistened with a mild detergent solvent. Then wipe the cabinet with a soft dry cloth.

LCD Periodic cleaning with a soft dry cloth is recommended.

SCREEN Don't use tissue paper etc. because these will damage the LCD screen.

BEFORE YOU OPERATE THE MONITOR

FEATURES

- ◆ Supports Resolutions up to 1920 × 1200
- ◆ High Contrast 1000:1 (Typical), Adv. Contrast Function Available / Brightness 300cd/m² (Typical)
- ◆ Blue Light Reducer
- ◆ Flicker-Free
- ◆ Digital Character Smoothing
- ◆ Automatic Set-up
- ◆ Stereo Speakers
2 × 2W Stereo Speakers
- ◆ Standby Feature (ENERGY STAR[®] and VESA DPMS Compliant)
- ◆ Ergonomic Design TCO Certified
- ◆ VESA Mounting Standard (100mm×100mm) Compliant
- ◆ Keyhole for Security Lock

CHECKING THE CONTENTS OF THE PACKAGE

The following accessories are included in your package. Check to see if they are enclosed with the monitor. If anything is missing or damaged, please contact your local iiyama dealer or regional iiyama office.

- Power Cable*¹
- Stand-Base*²
- Quick Start Guide
- DisplayPort Cable
- Stand-Base with a screw*³
- USB Cable
- Safety Guide

CAUTION

*¹ The rating of the Power Cable enclosed in 120V area is 10A/125V. If you are using a power supply higher than this rating, then a power cable with a rating of 10A/250V must be used. However, all guarantees and warranties are void for any problems or damage caused by a power cable not supplied by iiyama.

An approved power cable greater or equal to H05VVF, 3G, 0.75mm² must be used.

*² Accessory for ProLite XU2495WSU.

*³ Accessory for ProLite XUB2495WSU.

INSTALLATION

- WARNING** ■ Before installation, make sure the display arm or desk arm stand is strong enough to hold the necessary weight of the display and the mount.

< DISPLAY ARM OR DESK ARM STAND >

- WARNING** ■ When you use with the display arm or desk arm stand, in consideration of thickness of the mounting stage, tighten the M4 Screws (4pcs) with washer which “L” length is 10mm to fasten the monitor. Using the screw longer than this may cause electric shock or damage because it may contact with the electrical parts inside the monitor.

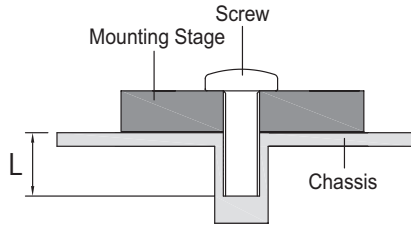

< ROTATING THE DISPLAY >

• ProLite XUB2495WSU

The monitor is designed to be compatible with both landscape and portrait modes. Video card for portrait display will be required for rotating the image on the screen.

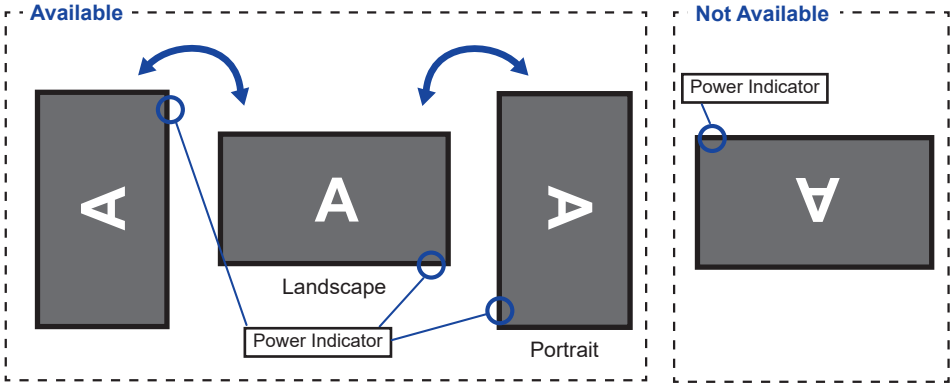

With Stand:

NOTE

- Adjust the monitor's height before panel rotation.
- Attempting to rotate the panel forcibly without adjusting the stand height may cause damage to the panel or the stand.

• ProLite XU2495WSU

The monitor is designed to be compatible in landscape mode.

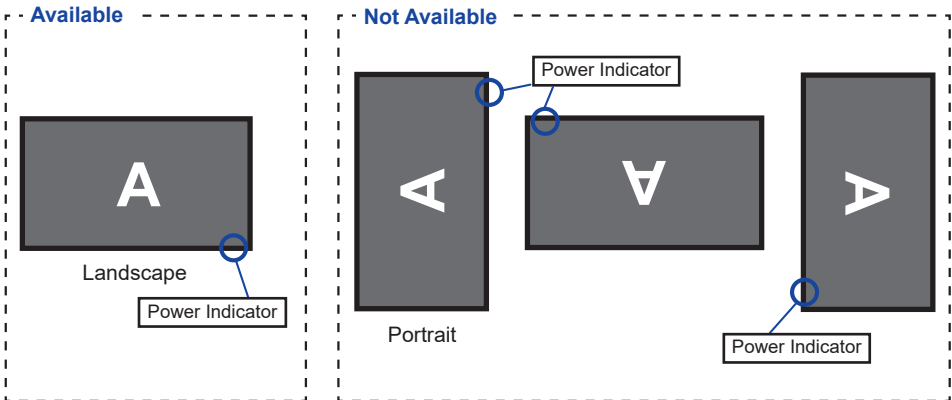

FITTING AND REMOVAL OF BASE : ProLite XUB2495WSU

CAUTION

- Put the monitor on a stable surface. The monitor may cause injury or damage if it falls or is dropped.
- Do not give a strong impact to the monitor. It may cause damage.
- Unplug the monitor before removal or installation to avoid an electric shock or a damage.

<Installation>

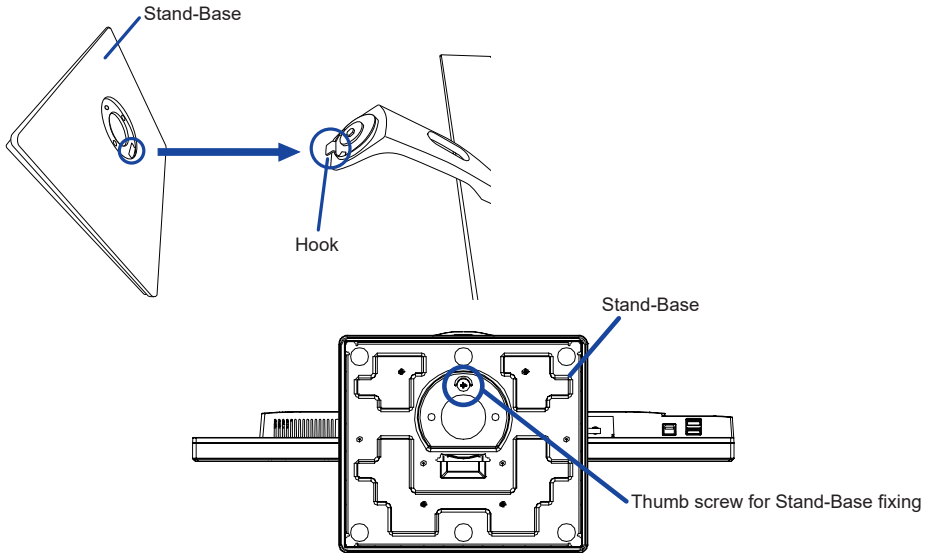

- ① Put a piece of soft cloth on the table beforehand to prevent the monitor from being scratched. Lay the monitor flat on a table with front face down.
- ② Install the stand-base as shown on above picture.
- ③ Use the 'thumb screw' provided to secure the base to the monitor.

<Removal>

- ① Put a piece of soft cloth on the table beforehand to prevent the monitor from being scratched. Lay the monitor flat on a table with front face down.
- ② Loosen the 'thumb screw' to remove the Stand-Base from the monitor.

FITTING AND REMOVAL OF BASE : ProLite XU2495WSU

CAUTION

- Put the monitor on a stable surface. The monitor may cause injury or damage if it falls or is dropped.
- Do not give a strong impact to the monitor. It may cause damage.
- Unplug the monitor before removal or installation to avoid an electric shock or a damage.

<Installation>

- ① Put a piece of soft cloth on the table beforehand to prevent the monitor from being scratched.
Lay the monitor flat on a table with front face down.
- ② Hold the monitor and install the Stand-Base to the monitor until it clicks and is secure.

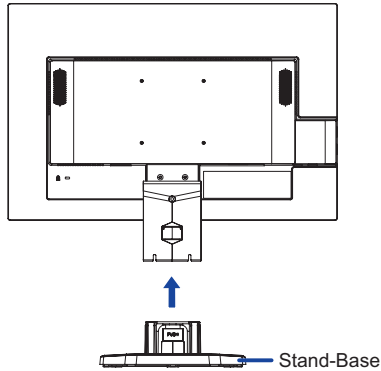

<Removal>

- ① Put a piece of soft cloth on the table beforehand to prevent the monitor from being scratched.
Lay the monitor flat on a table with front face down.
- ② Press the stopper at the back of the stand and remove the Stand-Base from the monitor.

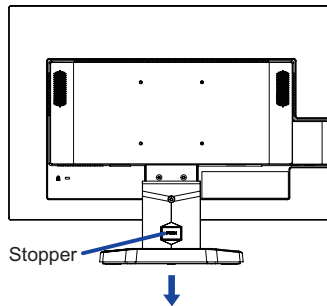



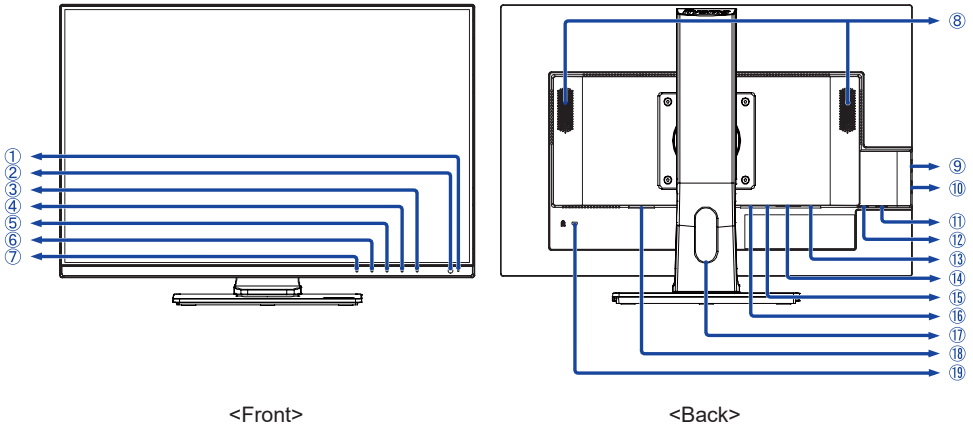







CONTROLS AND CONNECTORS : ProLite XUB2495WSU



ENGLISH

- ① Power Indicator

NOTE Blue: Normal operation
Orange: Standby mode

- ② Power Switch ()
- ③ Menu (ENTER)
- ④ Scroll Up / Volume ( / )
- ⑤ Scroll Down / ECO Mode ( / )
- ⑥ Exit / i-Style Color (EXIT)
- ⑦ Input Select (INPUT)
- ⑧ Speakers
- ⑨ USB Downstream Connector ( 5V, 500mA)
- ⑩ USB Downstream Connector ( 5V, 500mA)
- ⑪ USB Downstream Connector ( 5V, 500mA)
- ⑫ USB Upstream Connector ()
- ⑬ Headphone connector (HEADPHONE)
- ⑭ VGA Connector (VGA)
- ⑮ HDMI Connector (HDMI)
- ⑯ DisplayPort Connector (DP)
- ⑰ Cable Hole
- ⑱ AC Connector ( : Alternating current) ()
- ⑲ Keyhole for Security Lock

NOTE You can fasten a security lock and cable to prevent the monitor from being removed without your permission.

CONTROLS AND CONNECTORS : ProLite XU2495WSU

ENGLISH

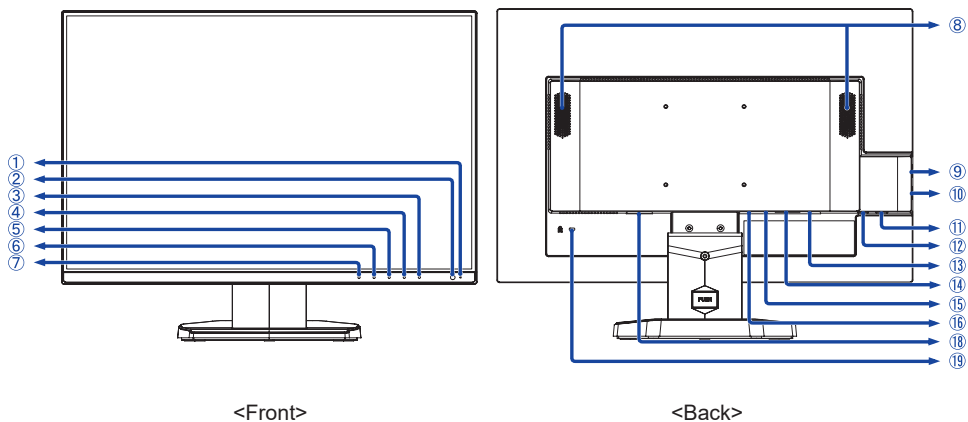

① Power Indicator

NOTE Blue: Normal operation
Orange: Standby mode

② Power Switch ()

③ Menu (ENTER)

④ Scroll Up / Volume (/)

⑤ Scroll Down / ECO Mode (/)

⑥ Exit / i-Style Color (EXIT)

⑦ Input Select (INPUT)

⑧ Speakers

⑨ USB Downstream Connector (5V, 500mA)

⑩ USB Downstream Connector (5V, 500mA)

⑪ USB Downstream Connector (5V, 500mA)

⑫ USB Upstream Connector ()

⑬ Headphone connector (HEADPHONE)

⑭ VGA Connector (VGA)

⑮ HDMI Connector (HDMI)

⑯ DisplayPort Connector (DP)

⑰ AC Connector (: Alternating current) ()

⑱ Keyhole for Security Lock

NOTE You can fasten a security lock and cable to prevent the monitor from being removed without your permission.

CONNECTING YOUR MONITOR : ProLite XUB2495WSU

- ① Ensure that both the computer and the monitor are switched off.
- ② Connect the computer to the monitor with the signal cable.
- ③ Connect the computer to the monitor with the USB Cable.
- ④ Connect the Power Cable to the monitor first and then to the power source.
- ⑤ Turn on your monitor and computer.

NOTE

- Make sure that the building installation has a circuit breaker of 120/240V, 20A (maximum).
- The signal cables used for connecting the computer and monitor may vary with the type of computer used. An incorrect connection may cause serious damage to both the monitor and the computer. The cable supplied with the monitor is for a standard connector. If a special cable is required please contact your local iiyama dealer or regional iiyama office.
- Make sure you tighten the finger screws at each end of the signal cable.
- The Class I pluggable equipment Type A must be connected to protective earth.
- The socket-outlet shall be installed near the equipment and shall be easily accessible.
- Excessive sound pressure from ear/headphones can cause hearing damage/hearing loss.

[Example of Connection]

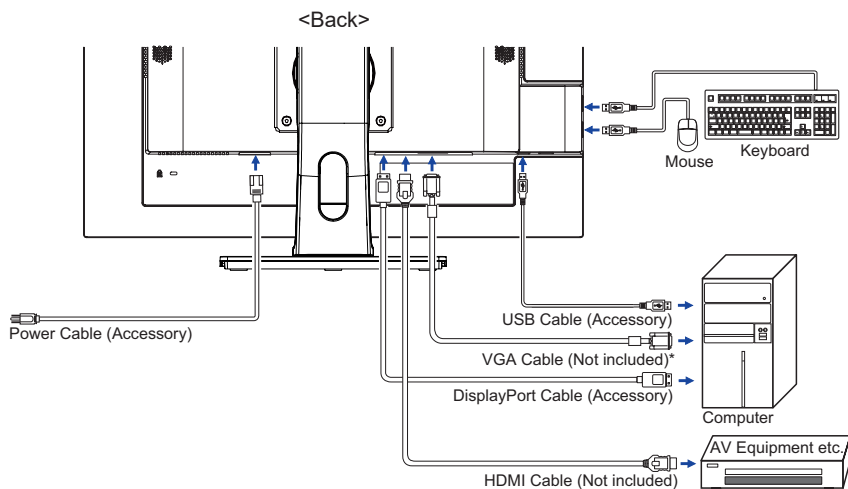

* VGA cable is not supplied with the monitor. If you use low quality VGA cable, it may cause a result of electro-magnetic interference. Please contact the iiyama Support Centre in your country if you wish to connect the monitor via the VGA input.

[Collect Cables]

Put the cables through the cable hole to bundle them.

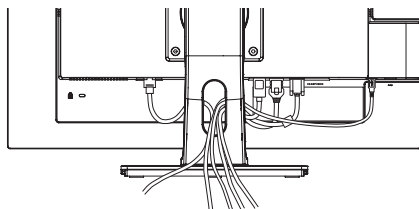

CONNECTING YOUR MONITOR : ProLite XU2495WSU

- ① Ensure that both the computer and the monitor are switched off.
- ② Connect the computer to the monitor with the signal cable.
- ③ Connect the computer to the monitor with the USB Cable.
- ④ Connect the Power Cable to the monitor first and then to the power source.
- ⑤ Turn on your monitor and computer.

NOTE

- Make sure that the building installation has a circuit breaker of 120/240V, 20A (maximum).
- The signal cables used for connecting the computer and monitor may vary with the type of computer used. An incorrect connection may cause serious damage to both the monitor and the computer. The cable supplied with the monitor is for a standard connector. If a special cable is required please contact your local iiyama dealer or regional iiyama office.
- Make sure you tighten the finger screws at each end of the signal cable.
- The Class I pluggable equipment Type A must be connected to protective earth.
- The socket-outlet shall be installed near the equipment and shall be easily accessible.
- Excessive sound pressure from ear-/headphones can cause hearing damage/hearing loss.

[Example of Connection]

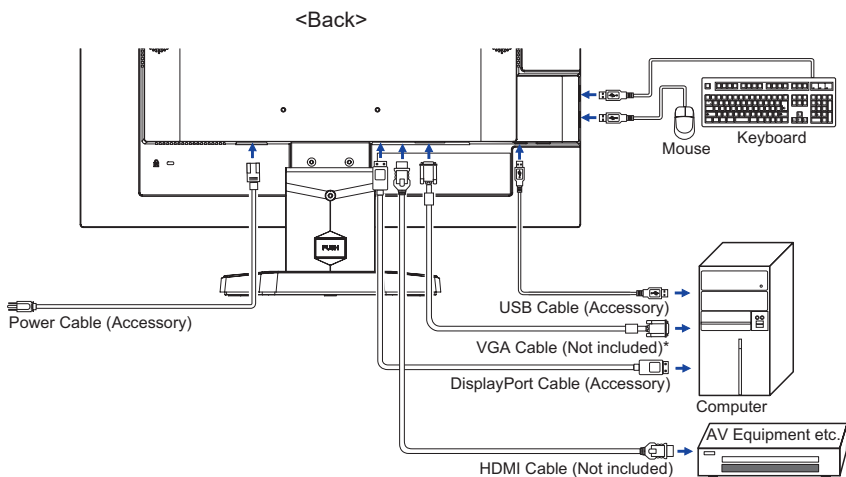

* VGA cable is not supplied with the monitor. If you use low quality VGA cable, it may cause a result of electro-magnetic interference. Please contact the iiyama Support Centre in your country if you wish to connect the monitor via the VGA input.

DISCONNECTING YOUR MONITOR

- ① Ensure that both the computer and the monitor are switched off.
- ② Disconnect the power source first and then the Power Cable from the monitor.
- ③ Disconnect the USB cable from the computer and the monitor.
- ④ Disconnect the signal cable from the computer and the monitor.

COMPUTER SETTING

■ Signal Timing

Change to the desired signal timing listed on page 36: COMPLIANT TIMING.

ADJUSTING THE VIEWING ANGLE : ProLite XU2495WSU

- For optimal viewing it is recommended to look at the full face of the monitor.
- Hold the stand so that the monitor does not topple when you change the monitor's angle.
- You are able to adjust the monitor's angle up to 22 degrees upward and 5 degrees downward.
- In order to ensure a healthy and relaxed body position when using the monitor at visual display workstations, it is recommended that the adjusted tilt angle should not exceed 10 degrees. Adjust the monitor's angle to your own preference.

NOTE

- Do not touch the LCD screen when you change the angle. It may cause damage or break the LCD screen.
- Careful attention is required not to pinch your fingers or hands into the moving part of the stand when you change the angle.

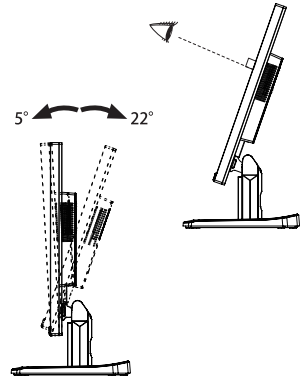

ADJUSTING THE HEIGHT AND THE VIEWING ANGLE : ProLite XUB2495WSU

- For optimal viewing it is recommended to position yourself directly opposite to the full face of the monitor, then adjust the monitor's height and angle to your own preference.
- Hold the panel so that the monitor does not topple when you change the monitor's height or angle.
- You are able to adjust the monitor's height up to 130mm, angle up to 45 degrees right and left, 22 degrees upward and 5 degrees downward.

NOTE

- Do not touch the LCD screen when you change the height or the angle. It may cause damage or break the LCD screen.
- Careful attention is required not to pinch your fingers or hands into the moving part of the stand when you change the height or the angle.
- Injury can occur if care is not taken to avoid finger contact with the displays base when adjusting the height.

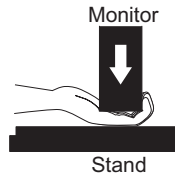
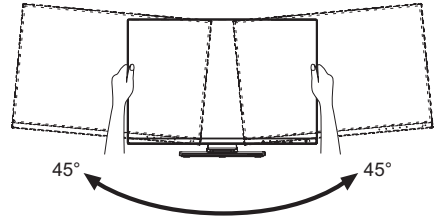
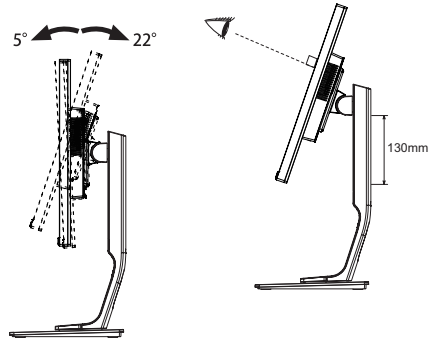

OPERATING THE MONITOR

To create the best picture, your iiyama LCD monitor has been preset at the factory with the COMPLIANT TIMING shown on page 36. You are also able to adjust the picture by following the button operation shown below. For more detailed adjustments, see page 27 for SCREEN ADJUSTMENTS.

- 1 Press the ENTER Button to start the On Screen Display feature. There are additional Menu items which can be switched by using the ◀/▶ Buttons.



- 2 Select the Menu item which contains the adjustment icon relating to the adjustment you want to make. Press the ENTER Button. Then, use the ◀/▶ Buttons to highlight the desired adjustment icon.
- 3 Press the ENTER Button again. Use the ◀/▶ Buttons to make the appropriate adjustment or setting.
- 4 Press the EXIT Button to leave the menu, and the settings you just made would be automatically saved.

For example, to correct for vertical position, select Menu item of Geometry and then press the ENTER Button. Then, select Vertical Position by using the ◀/▶ Buttons.

An adjustment page appears after you press the ENTER Button. Then, use the ◀/▶ Buttons to change the vertical position settings. The vertical position of the overall display should be changing accordingly while you are doing this.

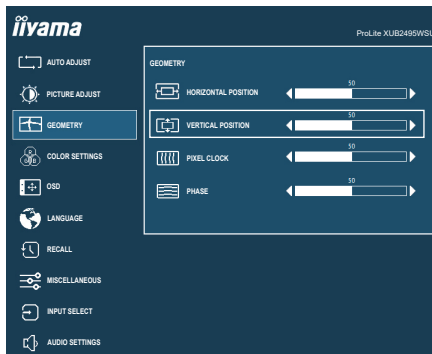

Press the EXIT Button lastly, it ends, all changes are saved in the memory.

NOTE

- When button operations are aborted during adjustment, On-Screen Display disappears when the time set for the OSD Timeout has passed. Also, press the EXIT button to quickly turn off the On-Screen Display.
- Any changes are automatically saved in the memory when the On Screen Display disappears. Turning off the power should be avoided while using the Menu.
- Adjustments for Horizontal / Vertical Position, Pixel Clock and Phase are saved for each signal timing. Except for these adjustments, all other adjustments have only one setting which applies to all signal timings.

ADJUSTMENT MENU CONTENTS

Auto Adjust		
Adjustment Item	Problem / Option	Button to Press
Auto Adjust *	Adjust H. / V. Position, Clock and Phase automatically.	

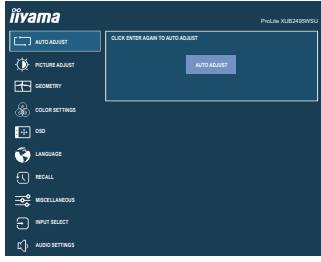

* Only Analog Input.
 For best results, use the Auto Adjust in conjunction with the adjustment pattern. See page 27 for SCREEN ADJUSTMENTS.

Picture Adjust

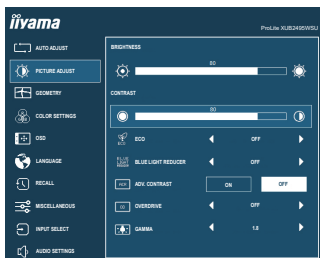

Adjustment Item	Problem / Option		Button to Press
Brightness*1,2,3	Too dark Too bright		
Contrast *2	Too dull Too intense		
ECO *4 Direct	Off	Normal	
	Mode1	Brightness of back-light is reduced.	
	Mode2	Brightness of back-light is reduced more than Mode1.	
	Mode3	Brightness of back-light is reduced more than Mode2.	
Blue Light Reducer *5	Off	Typical	
	Mode1	Blue light is reduced.	
	Mode2	Blue light is reduced more than Mode1.	
	Mode3	Blue light is reduced more than Mode2.	
Adv. Contrast *3	Off	Typical Contrast Ratio	
	On	Increased Contrast Ratio	
Overdrive	Off / 1 / 2 / 3 It will improve the gray level response time of the LCD panel. A higher level results in a faster response time.	 	
Gamma	1.8 / 2.0 / 2.2 / 2.4 You can set the Gamma.	 	

*1 Adjust the Brightness when you are using the monitor in a dark room and feel the screen is too bright.

*2 Contrast and Brightness adjustment disabled when i-Style Color is set to Game or Movie or Text or Scenery.

*3 Brightness and Adv. Contrast adjustment disabled when ECO is active.

*4 ECO cannot be adjusted and selected while Adv. Contrast is active.

*5 Blue Light Reducer is disabled when i-Style Color is activated.

Direct

You can skip the Menu items and directly display an option setting screen by using the following button operations.

- ECO: Press the Button when the Menu is not displayed.

Geometry *

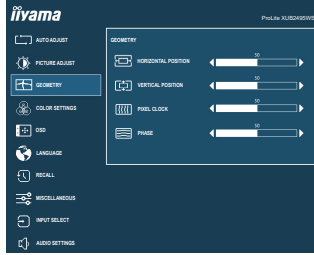

Adjustment Item	Problem / Option	Button to Press
Horizontal Position	Too left	
	Too right	
Vertical Position	Too low	
	Too high	
Pixel Clock	Too narrow	
	Too wide	
Phase	To correct flickering text or lines	

* Only Analog Input.
See page 27 for SCREEN ADJUSTMENTS.

Color Settings *

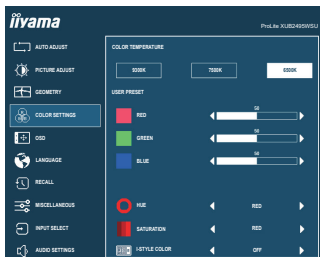

Adjustment Item	Problem / Option		Button to Press
Color Temperature	9300K	Bluish white	
	7500K	Greenish white	
	6500K	Reddish white	
User Preset	Red	Too weak	← →
	Green	Too strong	← →
	Blue		← →
Hue	Red	You can set the Colours.	← →
	Green		
	Blue		
	Cyan		
	Magenta		
	Yellow		
Saturation	Red	You can set the Colours.	← →
	Green		
	Blue		
	Cyan		
	Magenta		
	Yellow		
i-Style Color Direct	Off	Return to a state set by color adjustment except i-Style Color.	
	Standard	For general windows environment and monitor default setting.	
	Game	For PC game environment.	
	Cinema	For movie and video environment.	
	Scenery	For displaying outdoor scenery images	
	Text	For text editing and viewing in a word processing environment.	

* Color Settings adjustment is disabled when Blue Light Reducer is activated.





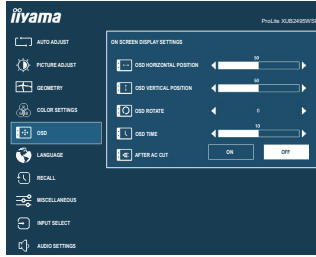

Direct

You can skip the Menu items and directly display an option setting screen by using the following button operations.

- i-Style Color : Press the EXIT Button when the Menu is not displayed.

OSD



Adjustment Item	Problem / Option	Button to Press
OSD Horizontal Position	OSD is too left OSD is too right	 
OSD Vertical Position	OSD is too low OSD is too high	 
OSD Rotate *	Rotate the OSD. 0° (Normal) / 90° (Rotate right) / -90° (Rotate left)	
OSD Time	You can set the OSD display duration time between 5 and 30 seconds.	 
After AC Cut	Off	When power is back, the monitor returns to the mode it was in before AC loss.
	On	Monitors stays in off mode when power is back. NOTE To turn the monitor back on, press the power switch.

* Available for ProLite XUB2495WSU only.

Language

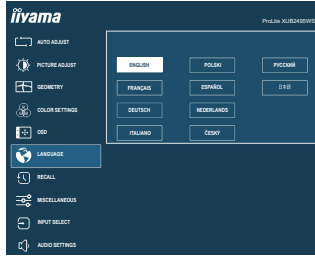

Adjustment Item	Problem / Option				Button to Press
Language	English	English	Español	Spanish	
	Français	French	Nederlands	Dutch	
	Deutsch	German	Česky	Czech	
	Italiano	Italian	Русский	Russian	
	Polski	Polish	日本語	Japanese	

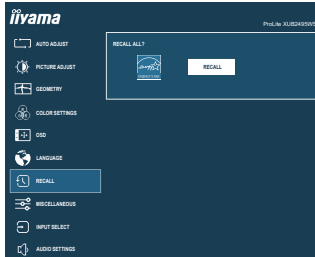

Recall

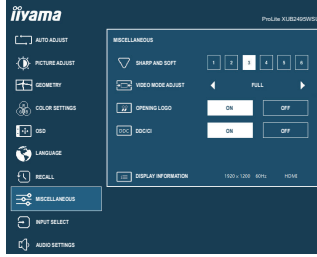

Adjustment Item	Problem / Option		Button to Press
Recall	Factory-preset data is restored.		

Miscellaneous



Adjustment Item	Problem / Option		Button to Press
Sharp and Soft	1 2 3 4 5 6 You can change the picture quality from 1 to 6 (sharp to soft). Press the ► Button to change the picture quality in numerical order. Press the ◀ Button to change the picture quality in reverse numerical order.		 
Video Mode Adjust *1	Full	Expansion display	
	Aspect *2	Expansion display of Aspect	
Opening Logo	Off	iiyama Logo does not display when the monitor is turned on.	
	On	iiyama Logo displayed when the monitor is turned on.	
DDC/CI	Off	DDC/CI function is turned Off.	
	On	Enable the DDC/CI function.	
Display Information	Displays information regarding the current input signal coming from the graphic card in your computer. NOTE See your graphic card user guide for more information about changing the resolution and refresh.		

*1 Only HDMI/DisplayPort inputs.

*2 Option unavailable with 16:9 resolution.

Input Select **Direct**

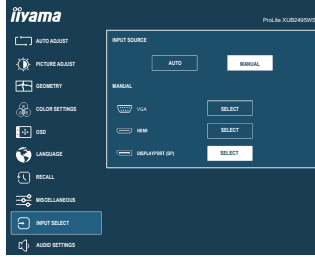

Adjustment Item	Problem / Option		Button to Press
Input Source	Auto		Search for an available input source and select automatically.
	Manual	VGA	Select the Analog (VGA) input.
		HDMI	Select the Digital (HDMI) input.
	DisplayPort	Select the Digital (DisplayPort) input.	

NOTE Input source is fixed, not selected automatically when VGA, HDMI and DisplayPort which are selected.



Direct

You can skip the Menu items and directly display an option setting screen by using the following button operations.

- Input Select : Press the INPUT button when the Menu is not displayed.

Audio Settings



Adjustment Item	Problem / Option	Button to Press
Volume Direct	Too soft Too loud	 
Mute Audio	Off	Return the sound volume to the previous level.
	On	Turn off the sound temporarily.

Direct

You can skip the Menu items and directly display an adjustment scale by using the following button operations.

- Volume: Press the  Button when the Menu is not displayed.

• Lock Mode

<OSD Menu>

1. The OSD lock will be activated by pressing the front buttons ENTER for about 5 seconds. Then, OSD LOCKED will appear on the screen.
2. The OSD lock will be deactivated by pressing the front buttons ENTER again for about 5 seconds.

<Power Switch>

1. The power switch lock will be activated by pressing the front buttons ◀ for about 5 seconds. Then, POWER LOCK will appear on the screen.
2. The power switch lock will be deactivated by pressing the front buttons ◀ again for about 5 seconds.

SCREEN ADJUSTMENTS

Adjust the image by following the procedure below to get the desired picture when selecting Analog input.

- The screen adjustments described in this manual are designed to set image position and minimize flicker or blur for the particular computer in use.
- The monitor is designed to provide the best performance at resolution of 1920 × 1200, but can not provide the best at resolutions of less than 1920 × 1200 because the picture is automatically stretched to fit the full screen. It is recommended to operate at resolution of 1920 × 1200 in normal use.
- Displayed text or lines will be blurred or irregular in thickness when the picture is stretched due to the screen enlargement process.
- It is preferable to adjust the image position and frequency with the monitor controls, rather than the computer software or utilities.
- Perform adjustments after a warm-up period of at least thirty minutes.
- Additional adjustments may be required after the Auto Image Adjust depending on the resolution or signal timing.
- The Auto Image Adjust may not work correctly when displaying the picture other than the screen adjustment pattern. In this case, manual adjustments are required.

There are two ways to adjust the screen. One way is automatic adjustment for Position, Clock and Phase. The other way is performing each adjustment manually.

Perform the Auto Image Adjust first when the monitor is connected to a new computer, or resolution is changed. If the screen has a flicker or blur, or the picture does not fit in the display area after performing the Auto Image Adjust, manual adjustments are required. Both adjustments should be made by using the screen adjustment pattern (Test.bmp) obtained via the Iiyama web site (<http://www.iiyama.com>).

Adjust the image by following the procedure below to get the desired picture.

This manual explains adjustment under Windows® OS.

- ① **Display the picture at the optimum resolution.**
- ② **Enter the Test.bmp (screen adjustment pattern) to wallpaper.**

NOTE

- Consult the appropriate documentation for doing this.
- Set the display position to center in the wallpaper setting dialogue box.

[Adjustment pattern]

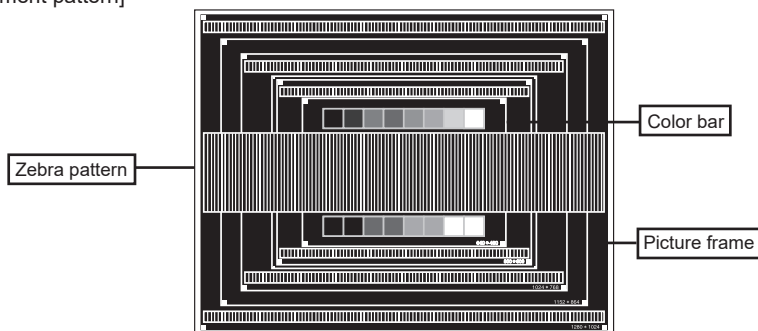

- ③ Adjust the "Auto Adjust".
- ④ Adjust the image manually by following procedure below when the screen has a flicker or blur, or the picture does not fit in the display area after performing the Auto Image Adjust.
- ⑤ Adjust the V.Position so that the top and bottom of the picture frame will fit to the display area.

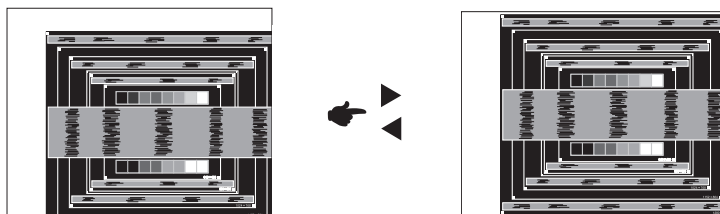

- ⑥ 1) Adjust the H.Position so that the left side of the picture frame will move to the left edge of the display area.

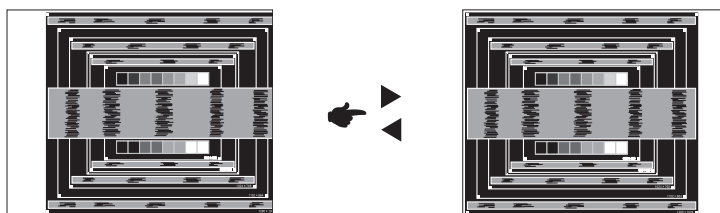

- 2) Stretch the right side of the picture frame to the right edge of the display area by adjusting the Clock.

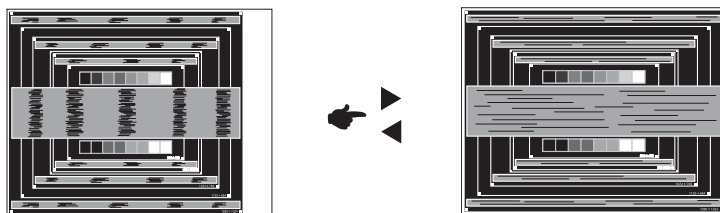
**NOTE**

- When the left side of the picture frame moves apart from the left edge of the display area during the Clock adjustment, adjust steps 1) and 2).
- Another way to make the Clock adjustment is to correct the vertical wavy lines in the zebra pattern.
- The picture may flicker during the Clock, H.Position and V.Position adjustment.
- In case the picture frame is bigger or smaller than the data display area after the Clock adjustment, repeat steps from ③.

⑦ Adjust the Phase to correct horizontal wavy noise, flicker or blur in the zebra pattern.

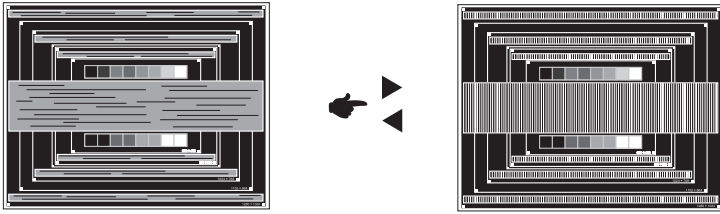

NOTE

- In case the strong flicker or blurs remain on a part of the screen, repeat steps ⑥ and ⑦ because the Clock may not be adjusted correctly.
- Adjust the H.Position after the Phase adjustment if the horizontal position moves during the adjustment.

⑧ Adjust the Brightness and Color to get the desired picture after you complete the Clock and Phase adjustments.

Put back your favorite wallpaper.

STANDBY FEATURE

The standby feature of this product complies with power saving requirement of ENERGY STAR® and VESA DPMS. When activated, it automatically reduces unnecessary power consumption of the monitor when your computer is not in use.

To use the feature, the monitor needs to be connected to a VESA DPMS compliant computer. There is a standby step the monitor takes as described below. The standby function, including any timer settings is configured by the operating system. Check your operating system manual for information on how this can be configured.

■ Standby Mode

When the video signal from the computer is off, the monitor enters into Standby Mode which reduces the power consumption to less than 0.5W*. The screen becomes dark, and the power indicator turns to orange. From Standby Mode, the image reappears in several seconds when either the keyboard or the mouse are touched again.

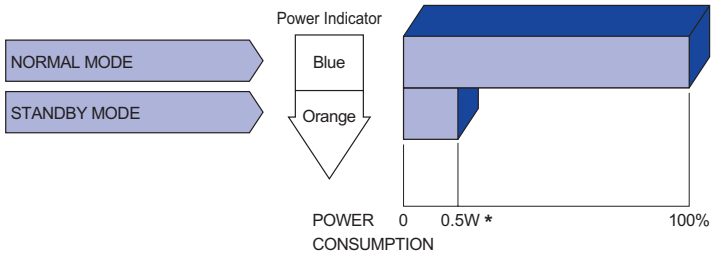

* USB peripherals and audio equipment are not connected.

NOTE

Even when using the standby mode, the monitor consumes electricity. Turn off the Power Switch whenever the monitor is not in use, during the night and weekends, to avoid unnecessary power consumption.

TROUBLE SHOOTING

If the monitor fails to operate correctly, please follow the steps below for a possible solution.

1. Perform the adjustments described in OPERATING THE MONITOR, depending on the problem you have. If the monitor does not get a picture, skip to 2.
2. Consult the following items if you cannot find an appropriate adjustment item in OPERATING THE MONITOR or if the problem persists.
3. If you are experiencing a problem which is not described below or you cannot correct the problem, discontinue using the monitor and contact your dealer or iiyama service center for further assistance.

Problem	Check
① The picture does not appear. (Power indicator does not light up.) (Power indicator is blue.) (Power indicator is orange.)	<input type="checkbox"/> The Power Cable is firmly seated in the socket. <input type="checkbox"/> The Power Switch is turned ON. <input type="checkbox"/> The AC socket is live. Please check with another piece of equipment. <input type="checkbox"/> If the blank screen saver is in active mode, touch the keyboard or the mouse. <input type="checkbox"/> Increase the Contrast and/or Brightness. <input type="checkbox"/> The computer is ON. <input type="checkbox"/> The Signal Cable is properly connected. <input type="checkbox"/> The signal timing of the computer is within the specification of the monitor. <input type="checkbox"/> If the monitor is in standby mode, touch the keyboard or the mouse. <input type="checkbox"/> The computer is ON. <input type="checkbox"/> The Signal Cable is properly connected. <input type="checkbox"/> The signal timing of the computer is within the specification of the monitor.
② The screen is not synchronized.	<input type="checkbox"/> The Signal Cable is properly connected. <input type="checkbox"/> The signal timing of the computer is within the specification of the monitor.
③ The screen position is not in the center.	<input type="checkbox"/> The signal timing of the computer is within the specification of the monitor.
④ The screen is too bright or too dark.	<input type="checkbox"/> The video output level of the computer is within the specification of the monitor.
⑤ The screen is shaking.	<input type="checkbox"/> The power voltage is within the specification of the monitor. <input type="checkbox"/> The signal timing of the computer is within the specification of the monitor.

Problem

Check

- ⑥ No sound.
- The audio equipment (computer etc.) is ON.
 - The Volume is turned up.
 - The Mute is OFF.
 - The audio output level of the audio equipment is within the specification of the monitor.
- ⑦ The sound is too loud or too quiet.
- The audio output level of the audio equipment is within the specification of the monitor.

RECYCLING INFORMATION

For better environment protection please don't dispose your monitor.
Please visit our web site: www.iiyama.com for monitor recycling.

APPENDIX

Design and specifications are subject to change without prior notice.

SPECIFICATIONS : ProLite XUB2495WSU

Size Category	24"	
LCD Panel	Panel technology	IPS (In-Plane-Switching)
	Size	Diagonal: 24.1" (61.13cm)
	Pixel pitch	0.27mm H × 0.27mm V
	Brightness	300cd/m ² (Typical)
	Contrast ratio	1000 : 1 (Typical)
	Viewable angle	Right / Left: 89 degrees each, Up / Down: 89 degrees each (Typical)
	Response time	5ms (Gray to Gray)* ¹
Display Colors	Approx. 16.7M	
Sync Frequency	Analog: Horizontal: 24.0-82.0kHz, Vertical: 46-66Hz Digital: Horizontal: 24.0-82.0kHz, Vertical: 46-66Hz	
Native Resolution	1920 × 1200, 2.3 MegaPixels	
Support max. resolution	VGA: 1920 × 1200 60Hz HDMI: 1920 × 1200 60Hz DisplayPort: 1920 × 1200 60Hz	
Input Connector	VGA, HDMI, DisplayPort	
Plug & Play	VESA DDC2B™	
Input Sync Signal	Separate sync: TTL, Positive or Negative	
Input Video Signal	Analog: 0.7Vp-p (Standard), 75Ω, Positive Digital: HDMI, DisplayPort	
USB Standard	USB2.0 (DC5V, 500mA)	
Number of USB Ports Connector shape	1 Upstream : Series B 4 Downstream : Series A	
Headphone Connector	ø 3.5mm mini jack (Stereo)	
Speakers	2W × 2 (Stereo speakers)	
Maximum Screen Size	518.4mm W × 324.0mm H / 20.4" W × 12.8" H	
Power Source	100-240VAC, 50/60Hz, 1.1A	
Power Consumption* ²	17W typical, Standby mode: 0.5W maximum	
Dimensions / Net Weight	532.0 × 387.0 - 517.0 × 210.0mm / 20.9 × 15.2 - 20.4 × 8.3" (W×H×D) 5.88kg / 12.9lbs	
Angle	Tilt: Upward: 22 degrees Downward: 5 degrees Swivel: Left/Right: 45 degrees each Rotation: Clockwise / Counterclockwise: 90 degrees each	
Environmental Considerations	Operating: Temperature 5 to 35°C / 41 to 95°F Humidity 10 to 80% (No condensation) Storage: Temperature -20 to 60°C / -4 to 140°F Humidity 5 to 85% (No condensation)	
Approvals	TCO Certified, CE, UKCA, TÜV-GS, VCCI, EAC, PSE, ENERGY STAR®	

NOTE *¹ When set to Over Drive +2.

*² USB peripherals and audio equipment are not connected.

SPECIFICATIONS : ProLite XU2495WSU

Size Category	24"	
LCD Panel	Panel technology	IPS (In-Plane-Switching)
	Size	Diagonal: 24.1" (61.13cm)
	Pixel pitch	0.27mm H × 0.27mm V
	Brightness	300cd/m ² (Typical)
	Contrast ratio	1000 : 1 (Typical)
	Viewable angle	Right / Left: 89 degrees each, Up / Down: 89 degrees each (Typical)
	Response time	5ms (Gray to Gray) ^{*1}
Display Colors	Approx.16.7M	
Sync Frequency	Analog: Horizontal: 24.0-82.0kHz, Vertical: 46-66Hz Digital: Horizontal: 24.0-82.0kHz, Vertical: 46-66Hz	
Native Resolution	1920 × 1200, 2.3 MegaPixels	
Support max. resolution	VGA: 1920 × 1200 60Hz HDMI: 1920 × 1200 60Hz DisplayPort: 1920 × 1200 60Hz	
Input Connector	VGA, HDMI, DisplayPort	
Plug & Play	VESA DDC2B™	
Input Sync Signal	Separate sync: TTL, Positive or Negative	
Input Video Signal	Analog: 0.7Vp-p (Standard), 75Ω, Positive Digital: HDMI, DisplayPort	
USB Standard	USB2.0 (DC5V, 500mA)	
Number of USB Ports	1 Upstream : Series B	
Connector shape	4 Downstream : Series A	
Headphone Connector	ø 3.5mm mini jack (Stereo)	
Speakers	2W × 2 (Stereo speakers)	
Maximum Screen Size	518.4mm W × 324.0mm H / 20.4" W × 12.8" H	
Power Source	100-240VAC, 50/60Hz, 1.1A	
Power Consumption ^{*2}	17W typical, Standby mode: 0.5W maximum	
Dimensions / Net Weight	532.0 × 422.5 × 216.5mm / 20.9 × 16.6 × 8.5" (W×H×D) 4.45kg / 9.8lbs	
Tilt Angle	Upward: 22 degrees, Downward: 5 degrees	
Environmental Considerations	Operating:	Temperature 5 to 35°C / 41 to 95°F Humidity 10 to 80% (No condensation)
	Storage:	Temperature -20 to 60°C / -4 to 140°F Humidity 5 to 85% (No condensation)
Approvals	TCO Certified, CE, UKCA, TÜV-GS, EAC, ENERGY STAR®	

NOTE

^{*1} When set to Over Drive +2.

^{*2} USB peripherals and audio equipment are not connected.

DIMENSIONS : ProLite XUB2495WSU

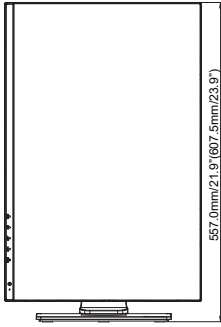
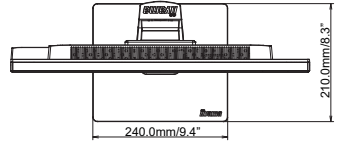
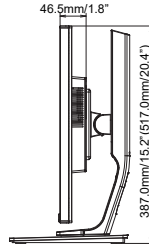
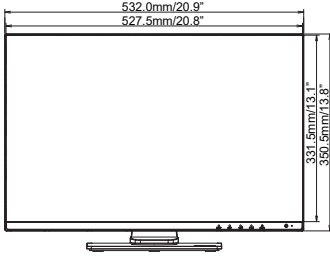

() : Maximum adjustment range

DIMENSIONS : ProLite XU2495WSU

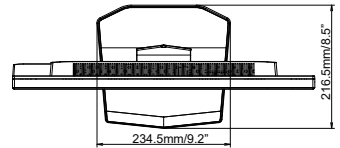
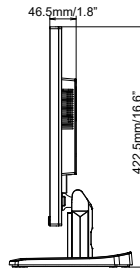
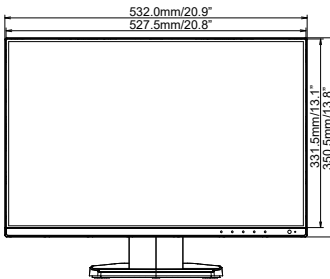

COMPLIANT TIMING

Video Mode	Horizontal Frequency	Vertical Frequency	Dot Clock
640 × 480	31.469kHz	59.940Hz	25.175MHz
800 × 600	35.156kHz	56.250Hz	36.000MHz
	37.879kHz	60.317Hz	40.000MHz
1024 × 768	48.363kHz	60.004Hz	65.000MHz
1280 × 1024	63.981kHz	60.020Hz	108.000MHz
1440 × 900	55.935kHz	59.887Hz	106.500MHz
1680 × 1050	65.290kHz	60.000Hz	146.250MHz
1920 × 1080	66.590kHz	59.930Hz	138.500MHz
1920 × 1200	74.038kHz	59.950Hz	154.000MHz