

Dell UltraSharp 24 Monitor - U2422H/U2422HX/U2422HE

User's Guide

Model: U2422H/U2422HX/U2422HE
Regulatory model: U2422Hb/U2422HEb



 **NOTE:** A NOTE indicates important information that helps you make better use of your computer.

 **CAUTION:** A CAUTION indicates potential damage to hardware or loss of data if instructions are not followed.

 **WARNING:** A WARNING indicates a potential for property damage, personal injury, or death.

Copyright © 2021 Dell Inc. or its subsidiaries. All rights reserved. Dell, EMC, and other trademarks are trademarks of Dell Inc. or its subsidiaries. Other trademarks may be trademarks of their respective owners.

2021 - 01

Rev. A00

Contents

About Your Monitor	6
Package Contents	6
Product Features	8
Identifying Parts and Controls	10
Front View	10
Back View	11
Bottom View	12
Monitor Specifications	17
Monitor Resolution Specifications	19
Supported Video Modes	19
Preset Display Modes	19
Multi-Stream Transport (MST) Modes	20
Monitor Electrical Specifications	20
Monitor Physical Characteristics	22
Monitor Environmental Characteristics	23
Pin Assignments	24
Plug and Play Capability	26
Universal Serial Bus (USB) Interface	26
USB 3.2 Downstream Connector	27
USB-C Connector	27
USB Ports	28
RJ45 Connector (U2422HE Only)	29
LCD Monitor Quality and Pixel Policy	31
Maintenance Guidelines	31
Cleaning Your Monitor	31
Setting Up the Monitor	32
Attaching the Stand	32



Organizing Your Cables	35
Connecting Your Monitor	35
Connecting the DisplayPort (DisplayPort to DisplayPort) Cable .	36
Connecting the HDMI Cable	37
Connecting the USB-C Cable (U2422HE Only)	37
Connecting the Monitor for DP Multi-Stream Transport (MST) Function	38
Connecting the Monitor for USB-C Multi-Stream Transport (MST) Function (U2422HE Only)	38
Connecting the Monitor for RJ45 Cable (optional) (U2422HE Only).	39
Connecting the USB-C to USB-A Cable	39
Dell Power Button Sync (DPBS) (U2422HE Only)	40
Connecting the Monitor for DPBS for the First Time	43
Using DPBS Function.	44
Connecting the Monitor for USB-C Multi-Stream Transport (MST) Function	46
Connecting the Monitor for USB-C	47
Using the Tilt, Swivel, and Vertical Extension	49
Tilt, Swivel	49
Vertical Extension	50
Rotating the Monitor	50
Rotate Clockwise	51
Rotate Counterclockwise.	51
Adjusting the Rotation Display Settings of Your System .	52
Removing the Monitor Stand	53
VESA Wall Mounting (optional)	53
Operating the Monitor	55
Power On the Monitor	55
Using the Joystick Control	55
Joystick Functions.	56





Using the Main Menu	56
Using the Menu Launcher	56
Menu Launcher Details	57
OSD Menu Details	58
OSD Messages	72
Initial Setup	72
OSD Warning Messages	73
Setting the KVM Switch (U2422HE Only)	77
Setting the Auto KVM (U2422HE Only)	79
Setting the Maximum Resolution	80
Multi-Monitor Sync (MMS)	81
Setting Multi-Monitor Sync (MMS)	82
Troubleshooting	83
Self-test	83
Lock/Unlock Menu and Built-in Diagnostics	84
Locking the Power and Joystick Buttons	84
Built-in Diagnostics	85
Always On USB-C Charging (U2422HE Only)	87
Updating Monitor Firmware	87
Common Problems	87
Product Specific Problems	91
Universal Serial Bus (USB) Specific Problems	93
Appendix	95
FCC Notices (U.S. only) and Other Regulatory Information	95
Contact Dell	95
EU Product Database for Energy Label and Product Information Sheet	95





About Your Monitor

Your monitor ships with the components shown in the table below. If any component is missing, contact Dell technical support. For more information, see [Contact Dell](#).

 **NOTE: Some items may be optional and may not ship with your monitor. Some features may not be available in certain countries.**

 **NOTE: If you are attaching a stand that you purchased from any other source, follow the set up instructions that were included with the stand.**

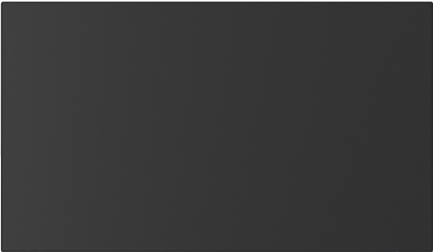
Package Contents

	Display
	Stand Riser
	Stand Base













	<p>Power Cable (varies by country)</p>
	<p>DP1.4 Cable (DP to DP) (U2422H/U2422HE only) Cable length: 1.80 M</p>
	<p>USB-A to USB-C Gen2 Cable Cable length: 1.00 M</p>
	<p>HDMI 2.0 Cable (U2422HX only) Cable length: 1.80 M</p>
	<p>USB-C to USB-C Gen2 Cable (U2422HE only) Cable length: 1.00 M</p>
	<ul style="list-style-type: none"> • Quick Setup Guide • Factory Calibration Report • Safety, Environmental, and Regulatory Information



Product Features

The **Dell U2422H/U2422HX/U2422HE** monitor has an active matrix, Thin-Film Transistor (TFT), Liquid Crystal Display (LCD) and LED backlight. The monitor features include:

- 60.47 cm (23.80 in.) viewable area (measured diagonally). 1920 x 1080 (16:9) resolution, plus full-screen support for lower resolutions.
- Wide viewing angle to allow viewing from a sitting or standing position.
- Color gamut of sRGB 100% and Rec. 709 100% with an average Delta E < 2; also supports DCI-P3 85%.
- Digital connectivity with DisplayPort, HDMI, and USB-C (with DP Alternate Mode) (U2422HE only).
- Single USB-C to supply power (PD 90 W) to a compatible notebook while receiving video & data signal (U2422HE only).
- Tilt, swivel, height, and rotate adjustment capabilities.
- Ultra-thin bezel minimizes the bezel gap in multi-monitor usage, enabling easier setup with an elegant viewing experience.
- Removable stand and Video Electronics Standards Association (VESA™) 100 mm mounting holes for flexible mounting solutions.
- U2422H/U2422HX is equipped with 1 USB-C upstream port  (data only, USB 3.2 Gen2, 10 Gbps), 2 super speed USB 10 Gbps (USB 3.2 Gen2) Type-A downstream ports , 1 super speed USB 10 Gbps (USB 3.2 Gen2) Type-A downstream charging port , and 1 super speed USB 10 Gbps (USB 3.2 Gen2) Type-C downstream port .
- U2422HE is equipped with 1 USB-C upstream port  (video and data; DP1.4 with Alternate mode, PD up to 90 W), 1 USB-C upstream port  (data only, USB 3.2 Gen2, 10 Gbps), 3 super speed USB 10 Gbps (USB 3.2 Gen2) Type-A downstream ports , 1 super speed USB 10 Gbps (USB 3.2 Gen2) Type-A downstream charging port , and 1 super speed USB 10 Gbps (USB 3.2 Gen2) Type-C downstream port .
- USB-C  and RJ45 ports  enable a single-cable, network-connected experience (U2422HE only).
- Plug and play capability if supported by your system.



- On-Screen Display (OSD) adjustments for ease of set-up and screen optimization.
- Power and OSD buttons lock.
- Security lock slot.
- Stand lock.
- ≤ 0.3 W in Standby Mode.
- Optimize eye comfort with a flicker-free screen.

⚠ WARNING: The possible long-term effects of blue light emission from the monitor may cause damage to the eyes, including eye fatigue, digital eye strain, and so on. ComfortView Plus feature is designed to reduce the amount of blue light emitted from the monitor to optimize eye comfort. The monitor uses low blue light panel and is in compliance with TÜV Rheinland at factory reset/default setting mode (Brightness: 75%, Contrast: 75%, CCT: 6500K, Preset mode: Standard)



Identifying Parts and Controls

Front View



Front View with Monitor Stand

No.	Description	Use
1	Power LED indicator	Solid white light indicates that the monitor is turned on and functioning normally. Blinking white light indicates that the monitor is in Standby Mode.



Back View



Back View with Monitor Stand



No.	Description	Use
1	VESA mounting holes (100 mm x 100 mm - behind the attached VESA Cover)	Wall mount monitor using VESA-compatible wall mount kit (100 mm x 100 mm).
2	Regulatory label	Lists the regulatory approvals.
3	Stand release button	Releases stand from the monitor.
4	Barcode, serial number, and Service Tag label	Contains monitor details and support information. Refer to this label if you need to contact Dell for technical support.
5	Power On/Off button	To turn the monitor on or off.
6	Joystick	Use to control the OSD menu. (For more Information, see Operating the Monitor)
7	Cable-management slot	Use to organize cables by inserting them through the slot.



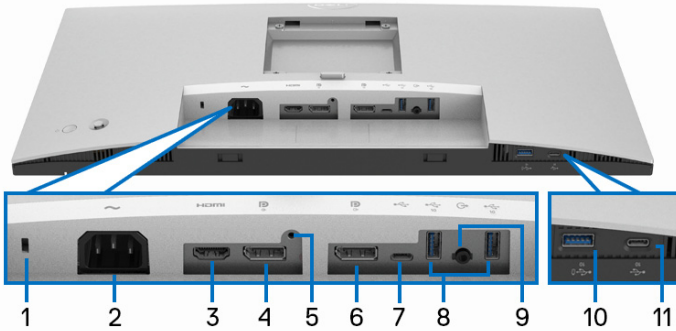

















Bottom View
U2422H/U2422HX



Bottom View without Monitor Stand

No.	Description	Use
1	Security lock slot	Secures the monitor with security lock (security lock not included).
2	Power connector 	Connect the power cable (shipped with your monitor).
3	HDMI port 	Connect your computer with the HDMI cable (shipped with U2422H).
4	DisplayPort 	Connect your computer with the DisplayPort cable.
5	Stand lock feature	To lock the stand to the monitor using a M3 x 6 mm screw (screw not included).



<p>6</p> 	<p>DisplayPort  (out)</p>	<p>DisplayPort output for MST (multi-stream transport) capable monitor. To enable MST, see Connecting the Monitor for DP Multi-Stream Transport (MST) Function.</p> <p>NOTE: Remove the rubber plug when using DisplayPort out  connector.</p>
<p>7</p> 	<p>USB-C upstream port  (data only)</p>	<p>Connect the USB-A to USB-C cable that came with your monitor to the computer. This port  supports USB data transfer at 10 Gbps (USB 3.2 Gen2). Once this cable is connected, you can use the USB connectors  on the monitor.</p> <p>NOTE: USB-C is not supported on versions of Windows prior to Windows 10.</p>
<p>8</p> 	<p>Super speed USB 10 Gbps (USB 3.2 Gen2) Type-A downstream port (2) </p>	<p>Connect your USB device.**</p> <p>NOTE: To use this port, you must connect the USB-A to USB-C cable (shipped with your monitor) to the USB-C upstream port  (data only) on the monitor and to your computer.</p>
<p>9</p> 	<p>Audio line-out port </p>	<p>Connect external speakers.*</p>
<p>10</p> 	<p>Super speed USB 10 Gbps (USB 3.2 Gen2) Type-A downstream port with Power Charging </p>	<p>Connect your USB device** or charge your device</p> <p>NOTE: To use this port, you must connect the USB-A to USB-C cable (shipped with your monitor) to the USB-C upstream port  (data only) on the monitor and to your computer.</p>
<p>11</p> 	<p>USB-C downstream port  (10 Gbps, 15 W)</p>	<p>Connect your USB device.**</p> <p>NOTE: To use this port, you must connect the USB-A to USB-C cable (shipped with your monitor) to the USB-C upstream port  (data only) on the monitor and to your computer.</p>

*Headphone usage is not supported for the audio line out connector.





**To avoid signal interference, when a wireless USB device has been connected to a USB downstream port, it is NOT recommended to connect any other USB devices to the adjacent port(s).

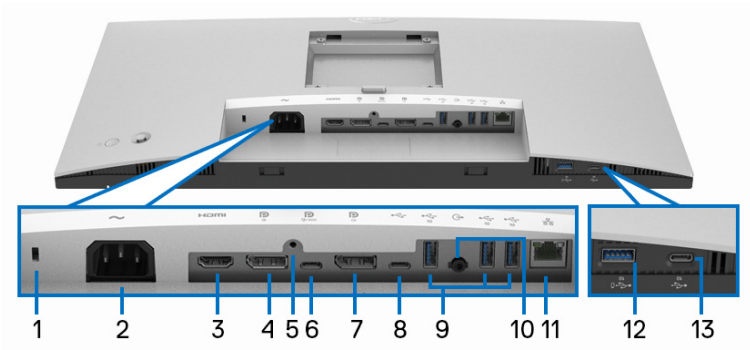









U2422HE













Bottom View without Monitor Stand

No.	Description	Use
1	Security lock slot	Secures the monitor with security lock (security lock not included).
2	Power connector 	Connect the power cable (shipped with your monitor).
3	HDMI port 	Connect your computer with the HDMI cable.
4	DisplayPort 	Connect your computer with the DisplayPort cable.
5	Stand lock feature	To lock the stand to the monitor using a M3 x 6 mm screw (screw not included).



<p>6</p>	<p>USB-C upstream port  (video + data)</p>	<p>Connect the USB-C to USB-C cable that came with your monitor to the computer or mobile device. This port supports USB Power Delivery, Data, and DisplayPort video signal. The super speed USB 10 Gbps (USB 3.2 Gen2) Type-C port  offers the fastest transfer rate and the alternate mode with DP 1.4 supports a maximum resolution of 1920 x 1080 at 60 Hz, PD 20 V/4.5 A, 15 V/3 A, 9 V/3 A, 5 V/3 A.</p> <p>NOTE: USB-C is not supported on versions of Windows prior to Windows 10.</p>
<p>7</p>	<p>DisplayPort  (out)</p> 	<p>DisplayPort output for MST (multi-stream transport) capable monitor. To enable MST, see Connecting the Monitor for DP Multi-Stream Transport (MST) Function.</p> <p>NOTE: Remove the rubber plug when using DisplayPort out  connector.</p>
<p>8</p>	<p>USB-C upstream port  (data only)</p> 	<p>Connect the USB-A to USB-C cable that came with your monitor to the computer. This port  supports USB data transfer at 10 Gbps (USB 3.2 Gen2). Once this cable is connected, you can use the USB connectors  on the monitor.</p> <p>NOTE: USB-C is not supported on versions of Windows prior to Windows 10.</p> <p>NOTE: Remove the rubber plug when using USB-C upstream port  (data only) connector.</p>



<p>9</p>	<p>Super speed USB 10 Gbps (USB 3.2 Gen2) Type-A downstream port (3) </p>	<p>Connect your USB device.**</p> <p>NOTE: To use this port, you must connect the USB-C to USB-C cable (shipped with your monitor) to the USB-C upstream port  (video + data) (#6) or connect the USB-A to USB-C cable (shipped with your monitor) to the USB-C upstream port  (data only) (#8) on the monitor and to your computer.</p>
<p>10</p>	<p>Audio line-out port </p>	<p>Connect external speakers.*</p>
<p>11</p>	<p>RJ45 port </p>	<p>Connect Internet. You can surf Internet via RJ45 only after you have connected the USB cable (USB-A to USB-C or USB-C to USB-C) from the computer to the monitor.</p>
<p>12</p>	<p>Super speed USB 10 Gbps (USB 3.2 Gen2) Type-A downstream port with Power Charging </p>	<p>Connect your USB device** or charge your device</p> <p>NOTE: To use this port, you must connect the USB-C to USB-C cable (shipped with your monitor) to the USB-C upstream port  (video + data) (#6) or connect the USB-A to USB-C cable (shipped with your monitor) to the USB-C upstream port  (data only) (#8) on the monitor and to your computer.</p>
<p>13</p>	<p>USB-C downstream port  (10 Gbps, 15 W)</p>	<p>Connect your USB device.**</p> <p>NOTE: To use this port, you must connect the USB-C to USB-C cable (shipped with your monitor) to the USB-C upstream port  (video + data) (#6) or connect the USB-A to USB-C cable (shipped with your monitor) to the USB-C upstream port  (data only) (#8) on the monitor and to your computer.</p>

*Headphone usage is not supported for the audio line out connector.











**To avoid signal interference, when a wireless USB device has been connected to a USB downstream port, it is NOT recommended to connect any other USB devices to the adjacent port(s).



Monitor Specifications

Model	U2422H/U2422HX/U2422HE
Screen type	Active matrix - TFT LCD
Panel technology	In-Plane Switching Technology
Aspect ratio	16:9
Viewable Image	
Diagonal	604.70 mm (23.80 in.)
Width (active area)	527.04 mm (20.75 in.)
Height (active area)	296.46 mm (11.67 in.)
Total area	156246.28 mm ² (242.15 in. ²)
Pixel pitch	0.2745 mm x 0.2745 mm
Pixel per inch (PPI)	92.53
Viewing angle	178° (vertical) typical 178° (horizontal) typical
Luminance output	250 cd/m ² (typical)
Contrast ratio	1000 to 1 (typical)
Faceplate coating	Anti-Glare with 3H hardness
Backlight	White LED edgelight system
Response time	8 ms (Normal) 5 ms (Fast)
Color depth	16.7 million colors
Color gamut	sRGB 100%, Rec. 709 100%, DCI-P3 85%
Calibration accuracy	sRGB & Rec. 709: Delta E < 2 (average)



Connectivity	<ul style="list-style-type: none"> • 1 x DisplayPort  version 1.4 (HDCP 1.4)* • 1 x HDMI port  version 1.4 (HDCP 1.4) • 1 x DisplayPort  (Out) with MST (HDCP 1.4) • 1 x USB-C upstream port  (video + data) (Alternate mode with DisplayPort 1.4, Power Delivery PD up to 90 W) (U2422HE only)** • 1 x USB-C upstream port  (data only, 10 Gbps USB 3.2 Gen2) • 1 x USB-C downstream port with charging capability  at 15 W (maximum) • 1 x super speed USB 10 Gbps (USB 3.2 Gen2) with BC1.2 charging capability  at 2 A (maximum) • 2 x super speed USB 10 Gbps (USB 3.2 Gen2) downstream port  (for U2422H/U2422HX) • 3 x super speed USB 10 Gbps (USB 3.2 Gen2) downstream port  (U2422HE only) • 1 x audio line-out port  • 1 x RJ45 port  (U2422HE only)
Border width (edge of monitor to active area)	5.30 mm (Top) 5.30 mm (Left/Right) 8.95 mm (Bottom)
Adjustability	
Height adjustable stand	150 mm
Tilt	-5° to 21°
Swivel	-45° to 45°
Pivot	-90° to 90°
Dell Display Manager compatibility	Easy Arrange and other key features
Security	Security lock slot (cable lock sold separately)

*DisplayPort 1.4/MST/DP audio is supported.

**HBR3/DisplayPort 1.4/MST/DP audio is supported.



Monitor Resolution Specifications

Model	U2422H/U2422HX/U2422HE
Horizontal scan range	30 kHz to 83 kHz (automatic)
Vertical scan range	56 Hz to 76 Hz (automatic)
Maximum preset resolution	1920 x 1080 at 60 Hz

Supported Video Modes

Model	U2422H/U2422HX
Video display capabilities (HDMI & DisplayPort)	480i*, 480p, 576i*, 576p, 720p, 1080i*, 1080p

Model	U2422HE
Video display capabilities (HDMI & DisplayPort & USB-C alternate mode)	480i*, 480p, 576i*, 576p, 720p, 1080i*, 1080p

*Supported by HDMI input only.

Preset Display Modes

Display Mode	Horizontal Frequency (kHz)	Vertical Frequency (Hz)	Pixel Clock (MHz)	Sync Polarity (Horizontal /Vertical)
VESA, 640 x 480	31.5	60.0	25.2	-/-
VESA, 640 x 480	37.5	75.0	31.5	-/-
IBM, 720 x 400	31.5	70.1	28.3	-/+
VESA, 800 x 600	37.9	60.3	40.0	+/+
VESA, 800 x 600	46.9	75.0	49.5	+/+
VESA, 1024 x 768	48.4	60.0	65.0	-/-
VESA, 1024 x 768	60.0	75.0	78.8	+/+



VESA, 1152 x 864	67.5	75.0	108.0	+/+
VESA, 1280 x 1024	64.0	60.0	108.0	+/+
VESA, 1280 x 1024	80.0	75.0	135.0	+/+
VESA, 1600 x 900	60.0	60.0	108.0	-/+
VESA, 1920 x 1080	67.5	60.0	148.5	+/+

 **NOTE: The + or - sign in Sync polarity denotes that the video sync signal is triggered by either the positive edge or the negative edge, respectively.**

Multi-Stream Transport (MST) Modes

Using USB-C (U2422HE only):

MST Source Monitor	Maximum Number of External Monitor that can be Supported
	1920 x 1080 at 60 Hz
1920 x 1080 at 60 Hz	<ul style="list-style-type: none"> • HBR3: 2 (with USB-C DP Alt mode) • HBR2: 1

Using DisplayPort:

MST Source Monitor	Maximum Number of External Monitor that can be Supported
	1920 x 1080 at 60 Hz
1920 x 1080 at 60 Hz	• 3

Monitor Electrical Specifications

Model	U2422H/U2422HX	U2422HE
Video input signals	<ul style="list-style-type: none"> • HDMI 1.4*/DisplayPort 1.4**, 600 mV for each differential line, 100 ohm input impedance per differential pair • USB-C (with Alternate mode) signal input support (U2422HE only)*** 	



AC input voltage/ frequency/current	100 VAC to 240 VAC / 50 Hz or 60 Hz \pm 3 Hz / 1.2 A (typical)	100 VAC to 240 VAC / 50 Hz or 60 Hz \pm 3 Hz / 2.1 A (typical)
Inrush current	<ul style="list-style-type: none"> • 120 V: 30 A (Max.) at 0°C (cold start) • 240 V: 60 A (Max.) at 0°C (cold start) 	<ul style="list-style-type: none"> • 120 V: 40 A (Max.) at 0°C (cold start) • 240 V: 80 A (Max.) at 0°C (cold start)
Power consumption	<ul style="list-style-type: none"> • 0.3 W (Off mode)¹ • 0.3 W (Standby mode)¹ • 11.6 W (On mode)¹ • 63 W (Max.)² • 11.06 W (Pon)³ • 38.47 kWh (TEC)³ 	<ul style="list-style-type: none"> • 0.3 W (Off mode)¹ • 0.3 W (Standby mode)¹ • 11.8 W (On mode)¹ • 210 W (Max.)² • 14.80 W (Pon)³ • 50.84 kWh (TEC)³

*Not supporting the HDMI 1.4 optional specification, including HDMI Ethernet Channel (HEC), Audio Return Channel (ARC), standard for 3D format and resolutions, and standard for 4K digital cinema resolution.

**DisplayPort 1.4/MST/DP audio is supported.

***HBR3/DisplayPort 1.4/MST/DP audio is supported.

¹ As defined in EU 2019/2021 and EU 2019/2013.

² Max brightness and contrast setting with maximum power loading on all USB ports.

³ Pon: Power consumption of On mode as defined in Energy Star 8.0 version.

TEC: Total energy consumption in kWh as defined in Energy Star 8.0 version.

This document is informational only and reflects laboratory performance. Your product may perform differently, depending on the software, components and peripherals you ordered and shall have no obligation to update such information.

Accordingly, the customer should not rely upon this information in making decisions about electrical tolerances or otherwise. No warranty as to accuracy or completeness is expressed or implied.





NOTE: This monitor is ENERGY STAR certified. This product qualifies for ENERGY STAR in the factory default settings which can be restored by “Factory Reset” function in the OSD menu. Changing the factory default settings or enabling other features may increase power consumption that could exceed the ENERGY STAR specified limit.



Monitor Physical Characteristics

Model	U2422H/U2422HX/U2422HE
Signal Cable Type	<ul style="list-style-type: none"> • Digital: DisplayPort, 20 pins (for U2422H/U2422HE) • Digital: HDMI, 19 pins (U2422HX only) • Universal Series Bus: Type-C, 24 pins (U2422HE only) • Universal Serial Bus: USB-C to USB-A
<p>NOTE: Dell monitors are designed to work optimally with the video cables that are shipped with your monitor. As Dell does not have control over the different cable suppliers in the market, the type of material, connector and process used to manufacture these cables, Dell does not guarantee video performance on cables that are not shipped with your Dell monitor.</p>	
Monitor Dimensions (with stand)	
Height (extended)	496.03 mm (19.53 in.)
Height (compressed)	364.00 mm (14.33 in.)
Width	537.64 mm (21.17 in.)
Depth	179.57 mm (7.07 in.)
Monitor Dimensions (without stand)	
Height	310.71 mm (12.23 in.)
Width	537.64 mm (21.17 in.)
Depth	48.50 mm (1.91 in.)
Stand Dimensions	
Height (extended)	410.80 mm (16.17 in.)



Height (compressed)	364.00 mm (14.33 in.)	
Width	245.00 mm (9.65 in.)	
Depth	179.57 mm (7.07 in.)	
Base	245.00 mm x 173.00 mm (9.65 in. x 6.81 in.)	
Monitor Weight		
Model	U2422H/U2422HX	U2422HE
Weight with packaging	7.82 kg (17.22 lb)	8.30 kg (18.28 lb)
Weight with stand assembly and cables	5.57 kg (12.27 lb)	6.06 kg (13.35 lb)
Weight without stand assembly (For wall mount or VESA mount considerations - no cables)	3.52 kg (7.75 lb)	3.96 kg (8.72 lb)
Weight of stand assembly	1.75 kg (3.85 lb)	1.75 kg (3.85 lb)

Monitor Environmental Characteristics

Model	U2422H/U2422HX	U2422HE
Compliant Standards		
<ul style="list-style-type: none"> ENERGY STAR certified monitor EPEAT registered where applicable. EPEAT registration varies by country. See www.epeat.net for registration status by country. RoHS-compliant TCO certified displays BFR/PVC free monitor (excluding external cables) Arsenic-free glass and Mercury-free for the panel only 		
Temperature		
Operating	0°C to 40°C (32°F to 104°F)	
Non-operating	<ul style="list-style-type: none"> Storage: -20°C to 60°C (-4°F to 140°F) Shipping: -20°C to 60°C (-4°F to 140°F) 	
Humidity		
Operating	10% to 80% (non-condensing)	



Non-operating	<ul style="list-style-type: none"> Storage: 5% to 90% (non-condensing) Shipping: 5% to 90% (non-condensing) 	
Altitude		
Operating	5000 m (16404 ft) (maximum)	
Non-operating	12192 m (40000 ft) (maximum)	
Thermal Dissipation	<ul style="list-style-type: none"> 221.78 BTU/hour (maximum) 42.65 BTU/hour (typical) 	<ul style="list-style-type: none"> 716.55 BTU/hour (maximum) 46.06 BTU/hour (typical)

Pin Assignments

DisplayPort Connector

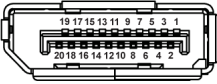

Pin Number	20-pin Side of the Connected Signal Cable
1	ML3 (n)
2	GND
3	ML3 (p)
4	ML2 (n)
5	GND
6	ML2 (p)
7	ML1 (n)
8	GND
9	ML1 (p)
10	ML0 (n)
11	GND
12	ML0 (p)
13	GND



14	GND
15	AUX (p)
16	GND
17	AUX (n)
18	Hot Plug Detect
19	Re-PWR
20	+3.3 V DP_PWR

HDMI Connector

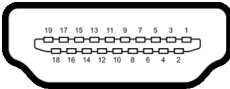

Pin Number	19-pin Side of the Connected Signal Cable
1	TMDS DATA 2+
2	TMDS DATA 2 SHIELD
3	TMDS DATA 2-
4	TMDS DATA 1+
5	TMDS DATA 1 SHIELD
6	TMDS DATA 1-
7	TMDS DATA 0+
8	TMDS DATA 0 SHIELD
9	TMDS DATA 0-
10	TMDS CLOCK+
11	TMDS CLOCK SHIELD
12	TMDS CLOCK-
13	CEC
14	Reserved (N.C. on device)
15	DDC CLOCK (SCL)



16	DDC DATA (SDA)
17	DDC/CEC Ground
18	+5 V POWER
19	HOT PLUG DETECT

Plug and Play Capability

You can install the monitor in any Plug and Play-compatible system. The monitor automatically provides the computer system with its Extended Display Identification Data (EDID) using Display Data Channel (DDC) protocols so that the system can configure itself and optimize the monitor settings. Most monitor installations are automatic; you can select different settings if desired. For more information about changing the monitor settings, see [Operating the Monitor](#).

Universal Serial Bus (USB) Interface

This section gives you information about the USB ports that are available on the monitor.

 **NOTE: This monitor is super speed USB 10 Gbps (USB 3.2 Gen2) compatible.**

Transfer Speed	Data Rate	Maximum Power Supported*
Super speed	10 Gbps	4.5 W
High speed	480 Mbps	4.5 W
Full speed	12 Mbps	4.5 W

*Up to 2 A on USB downstream port (with  battery icon) with BC1.2 compliance devices or normal USB devices.

USB-C (U2422HE only)	Description
Video	DisplayPort 1.4*
Data	super speed USB 10 Gbps (USB 3.2 Gen2)
Power Delivery (PD)	Up to 90 W

*HBR3/DisplayPort 1.4/MST/DP audio is supported.



USB 3.2 Downstream Connector



Pin Number	9-pin Side of the Connector
1	VCC
2	D-
3	D+
4	GND
5	SSRX-
6	SSRX+
7	GND
8	SSTX-
9	SSTX+

USB-C Connector

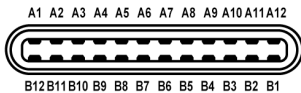







Pin Number	Signal Name	Pin Number	Signal Name
A1	GND	B1	GND
A2	TX1+	B2	TX2+
A3	TX1-	B3	TX2-
A4	VBUS	B4	VBUS
A5	CC1	B5	CC2
A6	D+	B6	D+
A7	D-	B7	D-
A8	SBU1	B8	SBU2



A9	VBUS	B9	VBUS
A10	RX2-	B10	RX1-
A11	RX2+	B11	RX1+
A12	GND	B12	GND

USB Ports

- 1 USB-C upstream  (video + data) (U2422HE only) - bottom
- 1 USB-C upstream  (data only) - bottom
- 1 USB-C downstream  - bottom
- 3 super speed USB 10 Gbps (USB 3.2 Gen2) Type-A downstream  (for U2422H/U2422HX) - bottom
- 4 super speed USB 10 Gbps (USB 3.2 Gen2) Type-A downstream  (U2422HE only) - bottom

Power Charging Port - the port with  battery icon; supports up to 2 A fast-charging capability if the device is BC1.2 compatible.

 **NOTE: Super speed USB 10 Gbps (USB 3.2 Gen2) functionality requires a super speed USB 10 Gbps (USB 3.2 Gen2)-capable computer.**

 **NOTE: The USB ports on the monitor work only when the monitor is turned On or in Standby Mode. If you turn Off the monitor and then turn it On, the attached peripherals may take a few seconds to resume normal functionality.**



RJ45 Connector (U2422HE Only)

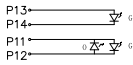
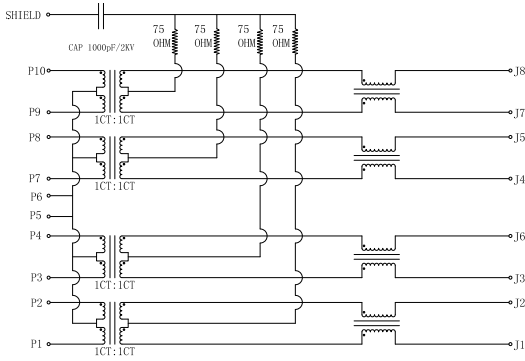

P1n	Green		Orange	Green
P13	+	P11	-	+
P14	-	P12	+	-

Pin	Signal	
P1	MDIO+	
P2	MDIO-	
P3	MDI1+	
P4	MDI1-	
P5	CT	
P6	CT	
P7	MDI2+	
P8	MDI2-	
P9	MDI3+	
P10	MDI3-	
Pin number	Orange	Green
P11	-	+
P12	+	-
P13	N/A	+
P14	N/A	-



Driver Installation

Install the Realtek USB GBE Ethernet Controller Driver available for your system. This is available for download at www.dell.com/support under the “Driver and download” section.

Network (RJ45) data rate via USB-C max speed is 1000 Mbps.

NOTE: This LAN port is 1000Base-T IEEE 802.3az compliant, supporting Mac Address (Printed on model label) Pass-thru, Wake-on-LAN (WOL) from standby mode (S3 only). It also supports PXE Boot function, include UEFI PXE and Legacy PXE. These features depend on BIOS setting and OS version.

RJ45 Connector LED Status



LED	Color	Description
Right LED	Amber or Green	Speed indicator: <ul style="list-style-type: none">• Amber On - 1000 Mbps• Green On - 100 Mbps• Off - 10 Mbps
Left LED	Green	Link / Activity indicator: <ul style="list-style-type: none">• Blinking - Activity on the port.• Green On - Link is being established.• Off - Link is not established.

NOTE: RJ45 cable is non in-box standard accessory.



LCD Monitor Quality and Pixel Policy

During the LCD Monitor manufacturing process, it is not uncommon for one or more pixels to become fixed in an unchanging state which are hard to see and do not affect the display quality or usability. For more information on Dell Monitor Quality and Pixel Policy, see <http://www.dell.com/pixelguidelines>.

Maintenance Guidelines

Cleaning Your Monitor

 **CAUTION:** Read and follow the [Safety instructions](#) before cleaning the monitor.

 **WARNING:** Before cleaning the monitor, unplug the monitor power cable from the electrical outlet.



For best practices, follow the instructions in the list below when unpacking, cleaning, or handling your monitor:

- To clean your anti-static screen, lightly dampen a soft, clean cloth with water. If possible, use a special screen-cleaning tissue or solution suitable for the anti-static coating. Do not use benzene, thinner, ammonia, abrasive cleaners, or compressed air.
- Use a lightly-dampened, warm cloth to clean the monitor. Avoid using detergent of any kind as some detergents leave a milky film on the monitor.
- If you notice white powder when you unpack your monitor, wipe it off with a cloth.
- Handle your monitor with care as a darker-colored monitor may get scratched and show white scuff marks more than a lighter-colored monitor.
- To help maintain the best image quality on your monitor, use a dynamically changing screen saver and turn off your monitor when not in use.



Setting Up the Monitor

Attaching the Stand

-  **NOTE:** The stand is not installed at the factory when shipped.
-  **NOTE:** The following instructions are applicable only for attaching the stand that was shipped with your monitor. If you are attaching a stand that you purchased from any other source, follow the set up instructions that were included with the stand.

To attach the monitor stand:

1. Follow the instructions on the flaps of carton to remove the stand from the top cushion that secures it.
2. Remove the stand riser and stand base from the packaging cushion.

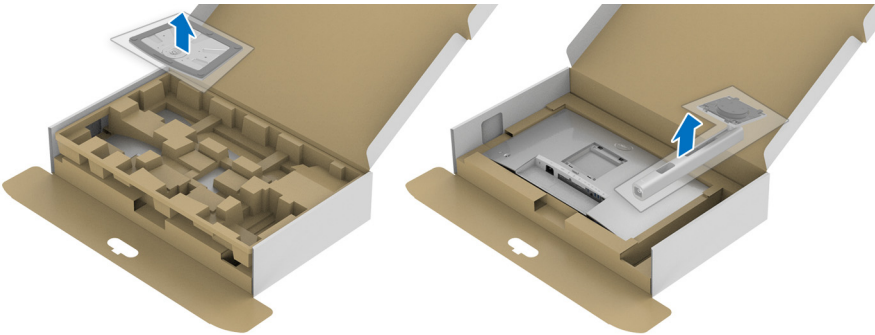

3. Insert the stand base blocks fully into the stand slot.
4. Lift the screw handle and turn the screw clockwise.
5. After fully tightening the screw, fold the screw handle flat within the recess.

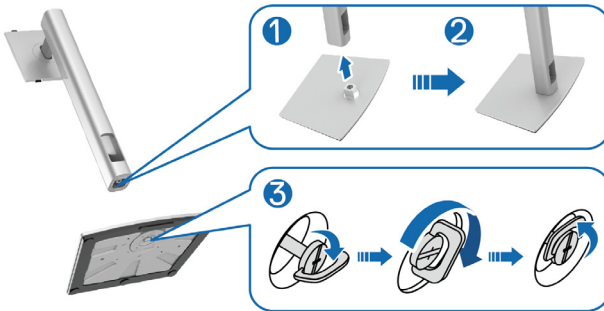

6. Lift the cover, as shown, to access the VESA area for stand assembly.

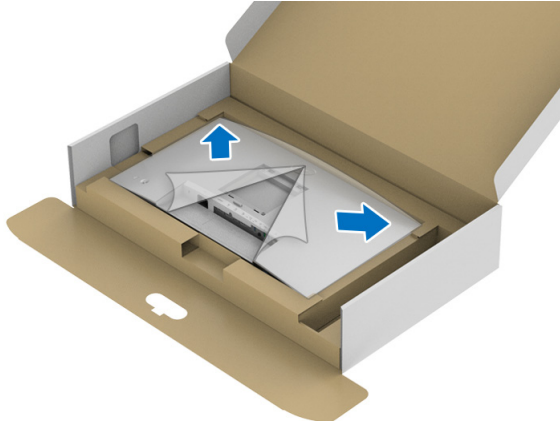

7. Attach the stand assembly to the monitor.

- a. Fit the two tabs on the upper part of the stand to the groove on the back of the monitor.
- b. Press the stand down till it snaps into place.



8. Place the monitor upright.

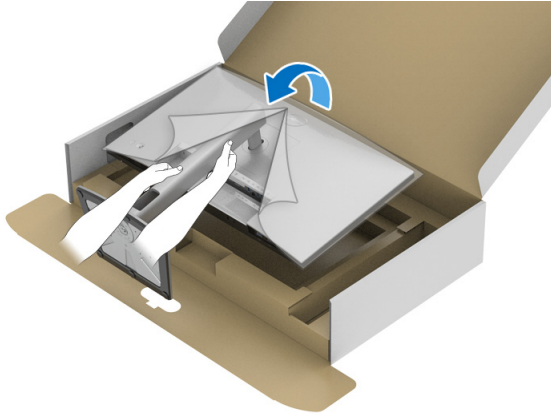

NOTE: Lift the monitor carefully to prevent it from slipping or falling.

9. Remove the cover from the monitor.

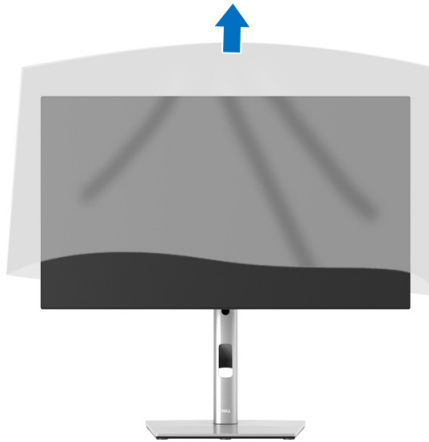

Organizing Your Cables



After attaching all necessary cables to your monitor and computer (See [Connecting Your Monitor](#) for cable attachment), organize all cables as shown above.

If your cable is not able to reach your PC, you may connect directly to the PC without routing through the slot on the monitor stand.

Connecting Your Monitor

⚠ WARNING: Before you begin any of the procedures in this section, follow the [Safety instructions](#).

✎ NOTE: Dell monitors are designed to work optimally with Dell supplied inbox cables. Dell does not guarantee the video quality and performance when using non-Dell cables.

✎ NOTE: Route the cables through the cable-management slot before connecting them.

✎ NOTE: Do not connect all cables to the computer at the same time.

✎ NOTE: The graphics are used for the purpose of illustration only. Appearance of the computer may vary.

To connect your monitor to the computer:



1. Turn Off your computer and disconnect the power cable.
2. Connect the DisplayPort, HDMI, or USB-C cable from your monitor to the computer.

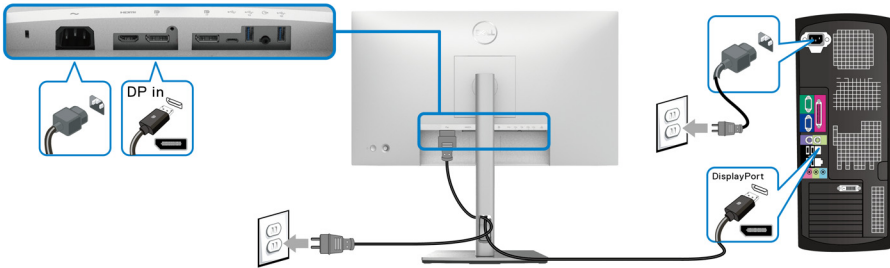

Connecting the DisplayPort (DisplayPort to DisplayPort) Cable



NOTE: The default out of factory setting is DP1.4 (DP1.2 is supported). If the monitor fails to show any content after the DisplayPort cable is connected, follow the procedures below to change the settings to DP1.1:

- Press the Joystick to open the Menu Launcher.
- Toggle the Joystick to select Input Source .
- Toggle the Joystick to highlight DP .
- Press and hold the Joystick for approximately 10 seconds, and the DisplayPort configuration message appears.
- Toggle the Joystick to select **Yes** and then press the Joystick to save the changes.

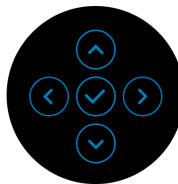

Repeat the above steps to change the DisplayPort format settings if necessary.



Connecting the HDMI Cable

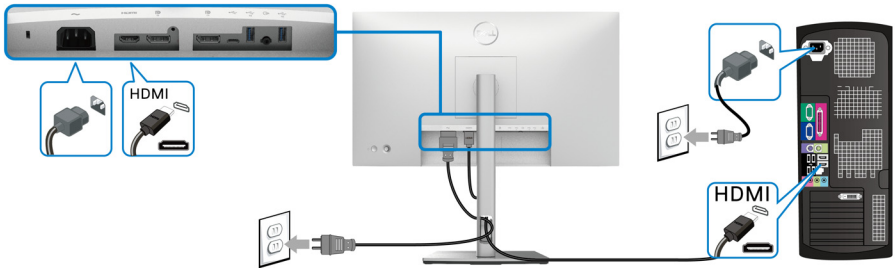

NOTE: The default out of factory setting is HDMI 1.4.

Connecting the USB-C Cable (U2422HE Only)

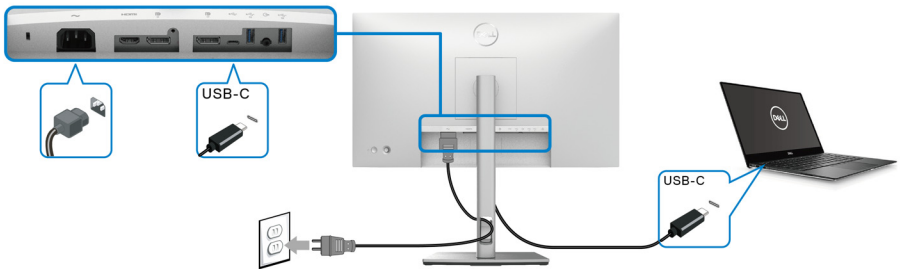

NOTE: Use the USB-C cable shipped with monitor only.

- This port  supports DisplayPort Alternate Mode (DP1.4 standard only).
- The USB-C power delivery compliant port (PD Version 3.0) delivers up to 90 W of power.
- If your notebook requires more than 90 W to operate and the battery is drained, it may not be powered up or charged with the USB PD port of this monitor.



Connecting the Monitor for DP Multi-Stream Transport (MST) Function

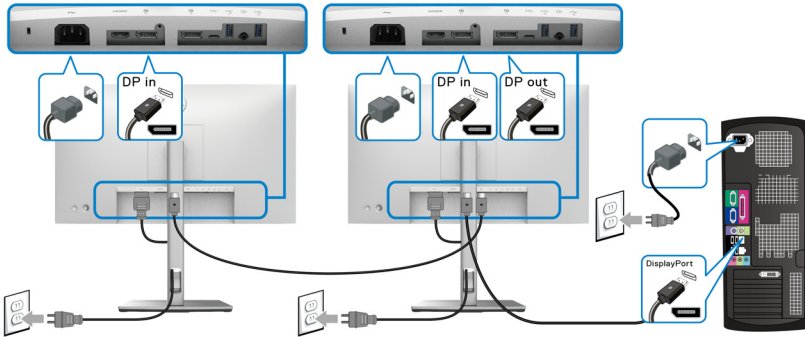

NOTE: This monitor supports the DP MST feature. To make use of this feature, your PC Graphics Card must be certified to at least DP1.2 with MST option.

NOTE: Remove the rubber plug when using DP out connector .

Connecting the Monitor for USB-C Multi-Stream Transport (MST) Function (U2422HE Only)

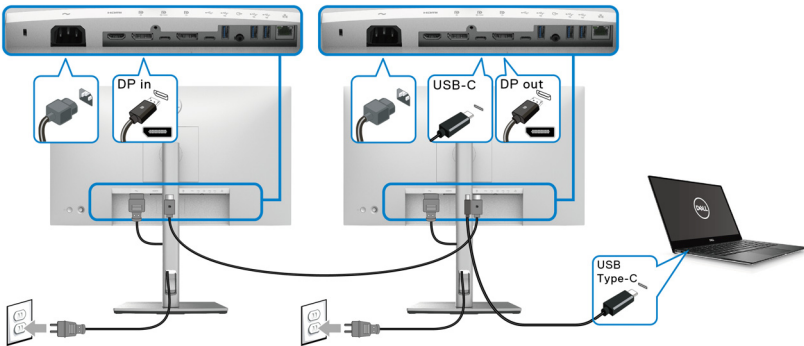

NOTE: The maximum number of supported monitors via MST is subjected to the bandwidth of the USB-C source.

NOTE: Remove the rubber plug when using USB-C upstream connector .

NOTE: Remove the rubber plug when using DP out  connector.



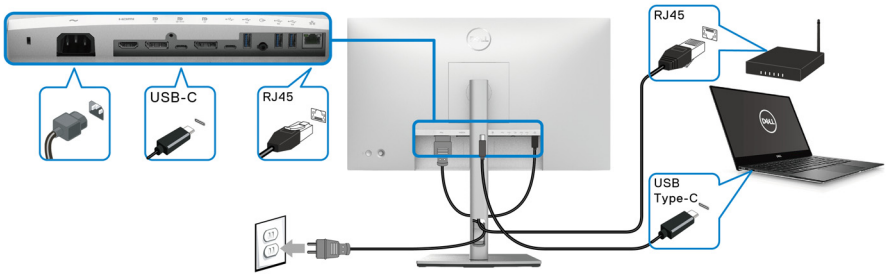

Connecting the Monitor for RJ45 Cable (optional) (U2422HE Only)



NOTE: RJ45 cable is non in-box standard accessory.

Connecting the USB-C to USB-A Cable

NOTE: To prevent data damage or loss, before unplugging the USB-C upstream port , ensure that NO USB storage devices are in use by the computer connected to the monitor's super speed USB 10 Gbps (USB 3.2 Gen2) Type-A downstream port .

After you have completed connecting the DisplayPort/HDMI cable, follow the procedures below to connect the USB-C to USB-A cable to the computer and complete your monitor setup:

1. Connect the computer: connect the USB-C upstream port  with the USB-C end of the cable (cable supplied).
2. Connect the USB-A end of the cable to an appropriate USB port on your computer.

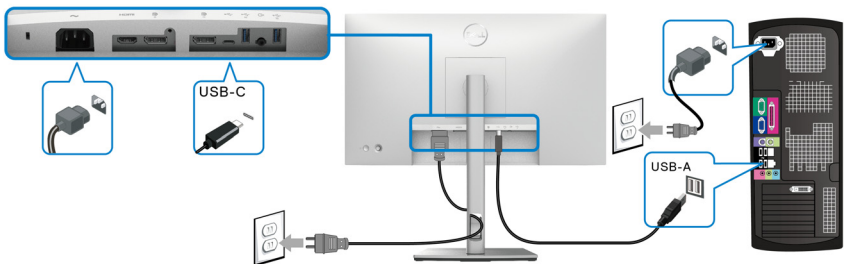

NOTE: Place the Desktop PC on the left side of the monitor (when viewing from the front) to ensure ease of connection of the USB-C to USB-A cable. Do not use the cable slot on the monitor stand if the length of the cable does not permit it.



3. Connect the USB peripherals to the super speed USB 10 Gbps (USB 3.2 Gen2) downstream ports  on the monitor.
4. Plug the power cables for your computer and monitor into a nearby outlet.

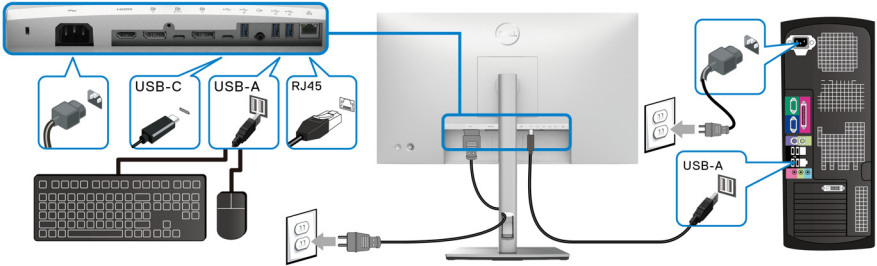

5. Turn On the monitor and the computer.
If your monitor displays an image, installation is complete. If it does not display an image, see [Common Problems](#).
6. Use the cable slot on the monitor stand to organize the cables.

 **NOTE: The USB connection only offers USB data transfer in this scenario.**

 **CAUTION: The graphics are used for the purpose of illustration only. Appearance of the computer may vary.**

Dell Power Button Sync (DPBS) (U2422HE Only)

The U2422HE monitor is designed with Dell Power Button Sync (DPBS) feature to allow you to control PC system power state from the monitor power button. This feature is compatible with Dell Optiplex 7090/3090 Ultra platform, and is only supported over USB-C interface.

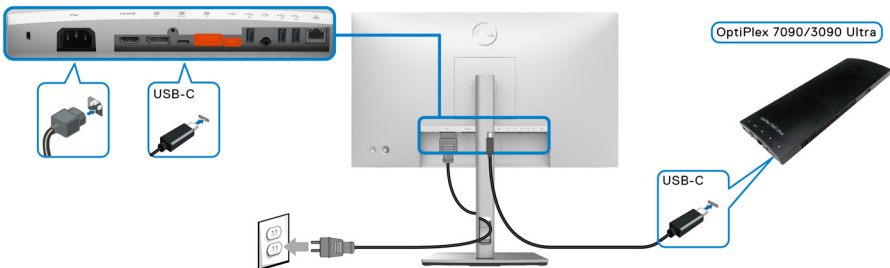

To make sure the DPBS function works for the first time, perform the following steps for Dell Optiplex 7090/3090 Ultra platform in the **Control Panel** first.

 **NOTE: DPBS only supports the port with  icon.**

- Go to **Control Panel**.

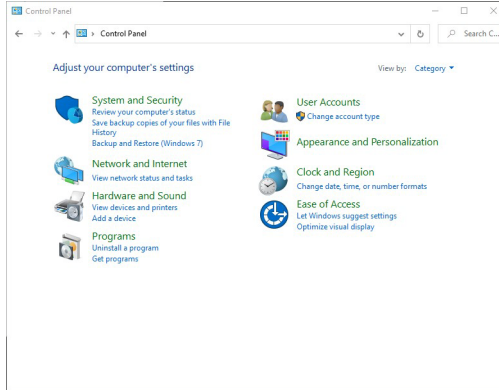

- Select **Hardware and Sound**, followed by **Power Options**.

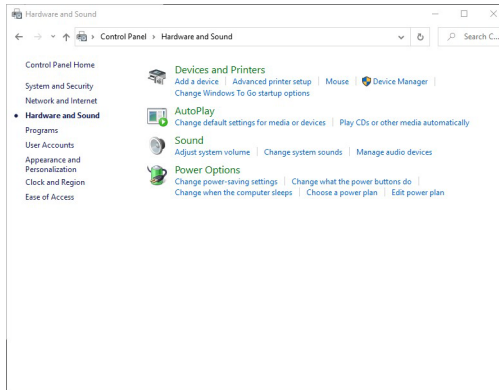

- Go to **System Settings**.

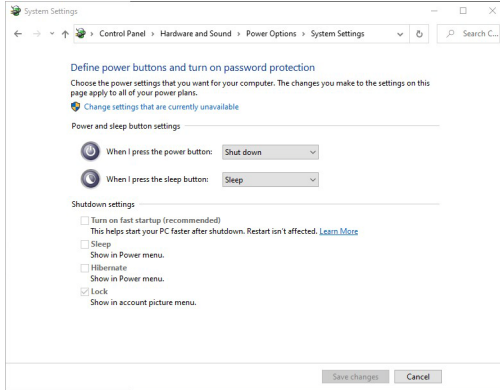

- In the drop-down menu of **When I press the power button**, there are a few options for selection, namely **Do nothing/Sleep/Hibernate/Shut down**. You can select **Sleep/Hibernate/Shut down**.

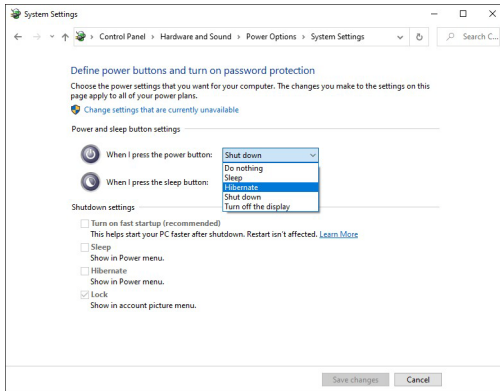

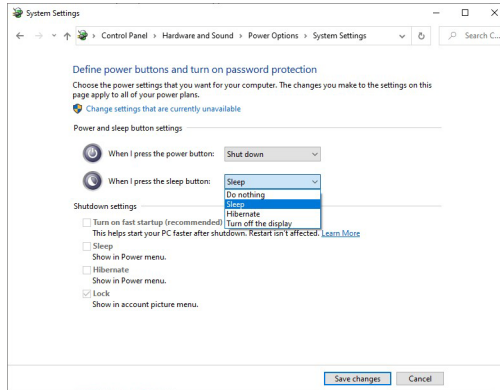

NOTE: Do not select “Do nothing”, otherwise monitor power button will not be able to sync with PC system power state.

Connecting the Monitor for DPBS for the First Time

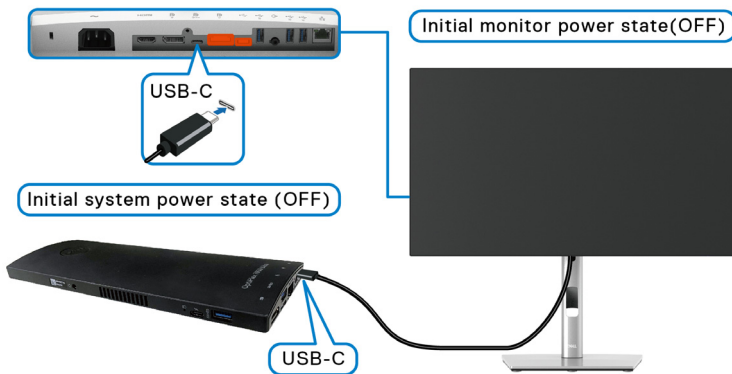

When setting up the DPBS function for the first time, please follow the steps below:

1. Make sure both the PC and the monitor are OFF.
2. Press the monitor power button to turn ON the monitor.
3. Connect the USB-C cable from the PC to the monitor.
4. Both the monitor and PC will turn ON momentarily. Wait for a while (approximately 6 seconds) and both the PC and the monitor will turn OFF.
5. Press the monitor or PC power button, both the PC and monitor will turn ON. Now the PC system power state is in sync with the monitor power button.



NOTE: When the monitor and PC are both at power OFF state at the first time, it is recommended that you turn ON the monitor first, then connect the USB-C cable from the PC to the monitor.

NOTE: You can power the Optiplex 7090/3090 Ultra platform using its DC adaptor jack. Alternatively, you can power the Optiplex 7090/3090 Ultra platform using the monitor's USB-C cable via Power Delivery (PD); please set USB-C Charging ⚡ 90W to On in Off Mode.

Using DPBS Function

When you connect the USB-C cable, the Monitor/PC state is as follows:

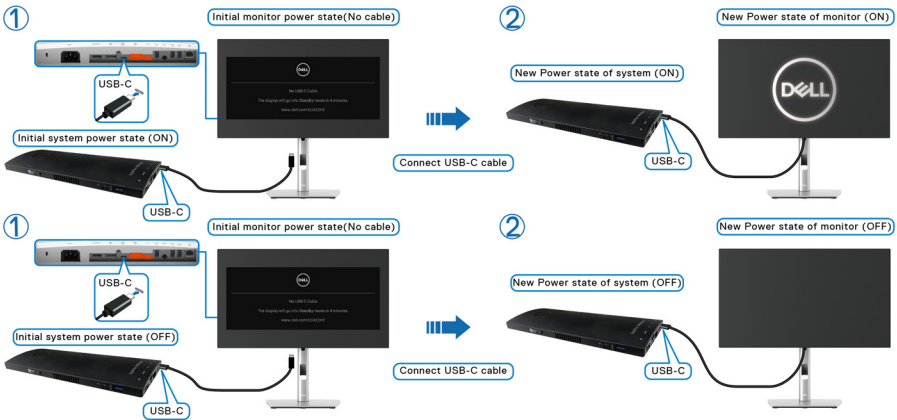

When you press the monitor power button or PC power button, the Monitor/PC state is as follows:

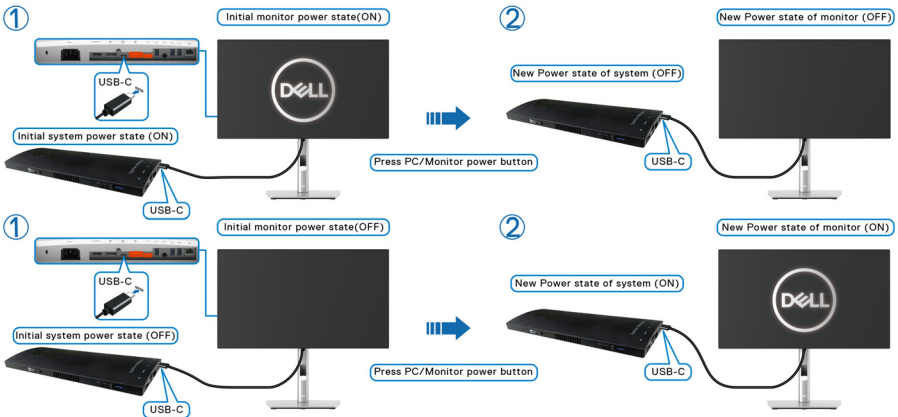

- When the monitor and the PC power state are both ON, **press and hold the monitor power button for 4 seconds**, the screen prompt will ask if you would like to shut down the PC.

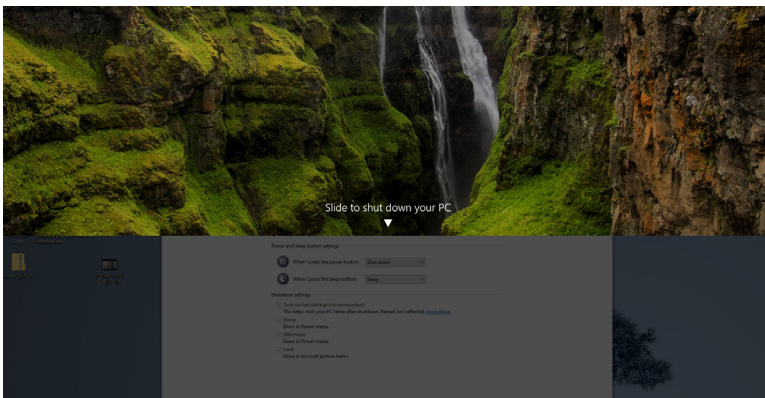
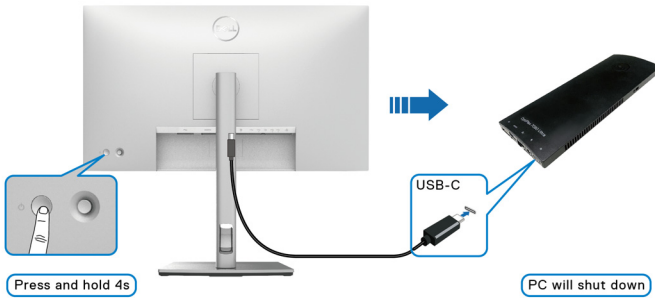

- When the monitor and the PC power state are both ON, **press and hold the monitor power button for 10 seconds**, the PC will shut down.

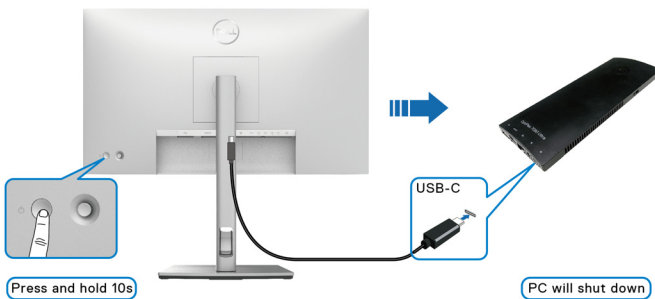

Connecting the Monitor for USB-C Multi-Stream Transport (MST) Function

A PC is connected to two monitors in an initially OFF power state, and the PC system power state is in sync with Monitor 1 power button. When you press Monitor 1 or PC power button, both Monitor 1 and PC turns ON. Meanwhile, Monitor 2 will remain OFF. You need to manually press the power button on Monitor 2 to turn it ON.

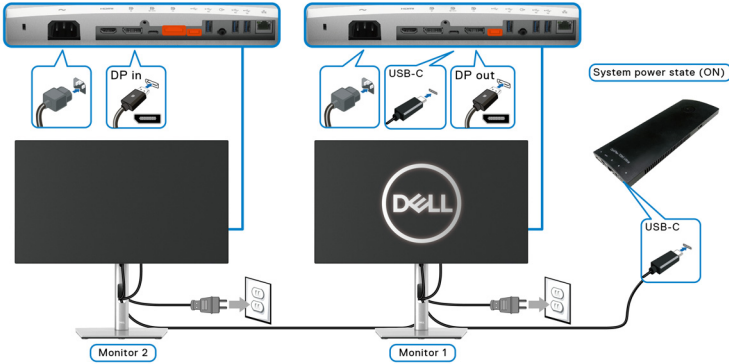

Similarly, a PC is connected to two monitors in an initially ON power state, and the PC system power state is in sync with Monitor 1 power button. When you press Monitor 1 or PC power button, both Monitor 1 and PC turns OFF. Meanwhile, Monitor 2 will be in Standby mode. You need to manually press the power button on Monitor 2 to turn it OFF.

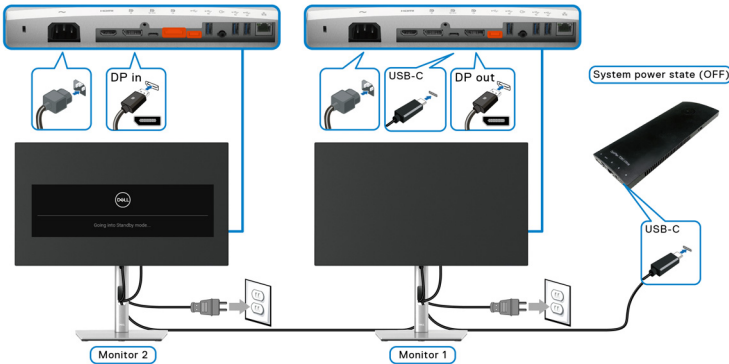

Connecting the Monitor for USB-C

The Dell OptiPlex 7090 Ultra platform has two USB-C ports, so both Monitor 1 and Monitor 2 power state can sync with the PC.

When the PC and two monitors are in an initially ON power state, pressing the power button on Monitor 1 or Monitor 2 will turn OFF the PC, Monitor 1, and Monitor 2.

NOTE: DPBS only supports the port with  icon.

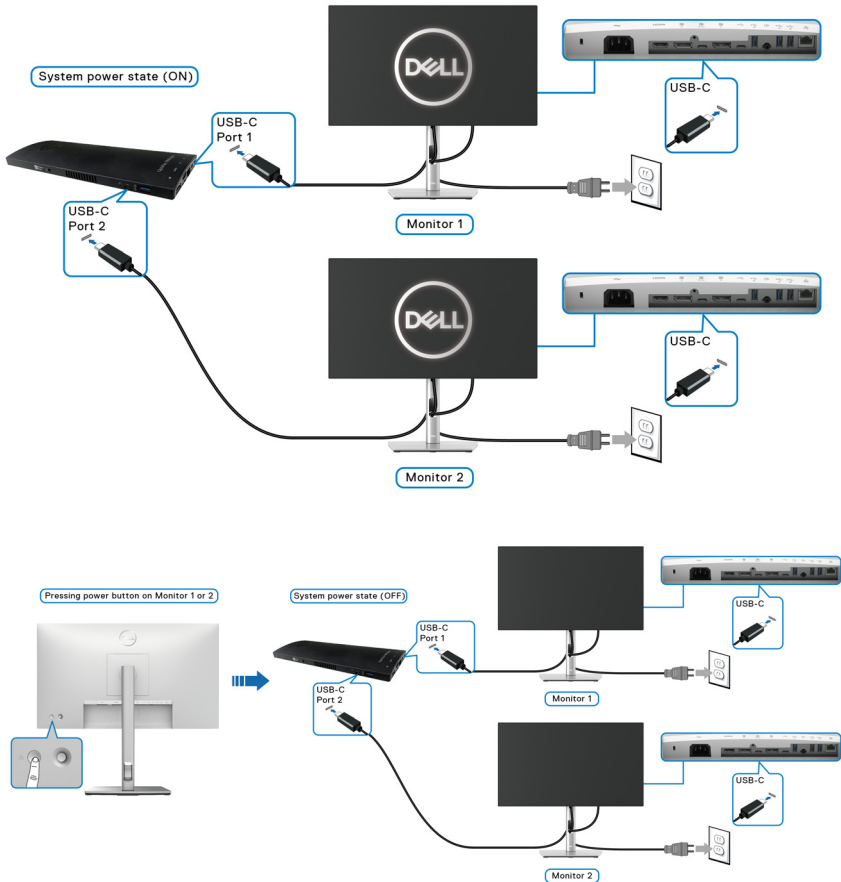

Ensure to set **USB-C Charging @ 90W to On in Off Mode**. When the PC and two monitors are in an initially OFF power state, pressing the power button on Monitor 1 or Monitor 2 will turn ON the PC, Monitor 1, and Monitor 2.

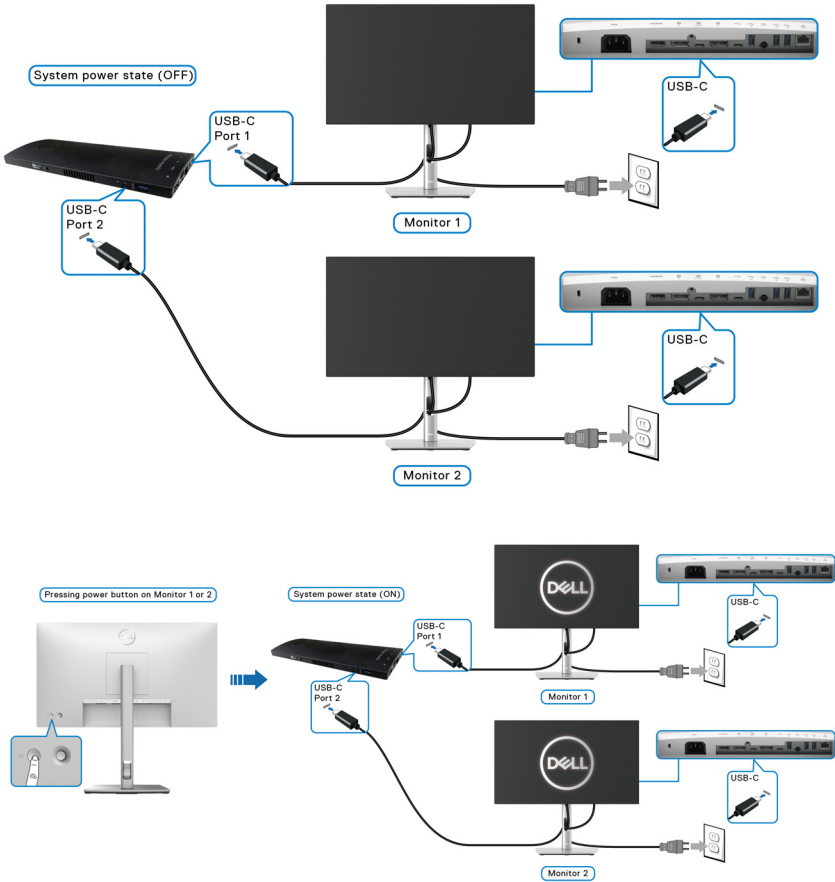

Using the Tilt, Swivel, and Vertical Extension

NOTE: The following instructions are applicable only for attaching the stand that was shipped with your monitor. If you are attaching a stand that you purchased from any other source, follow the set up instructions that were included with the stand.

Tilt, Swivel

With the stand attached to the monitor, you can tilt and swivel the monitor for the most comfortable viewing angle.

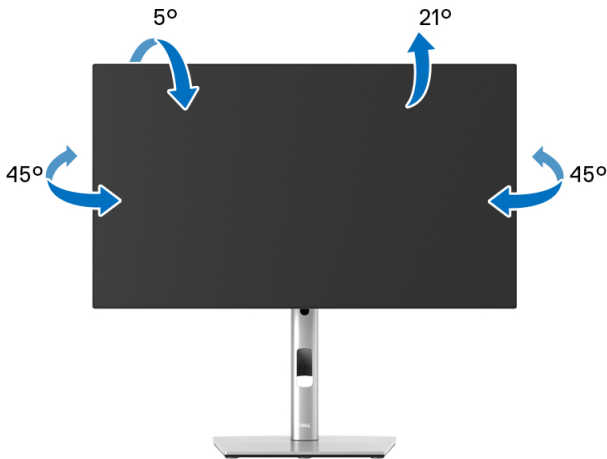

NOTE: The stand is not installed at the factory when shipped.



Vertical Extension

 **NOTE:** The stand extends vertically up to 150 mm. The figure below illustrates how to extend the stand vertically.

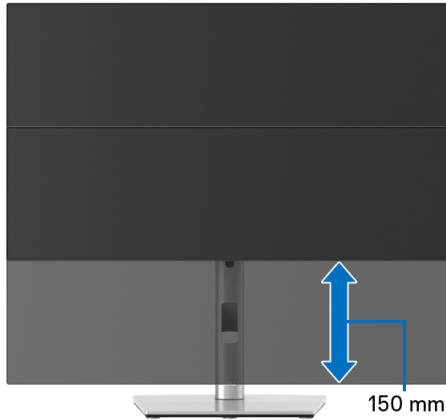

Rotating the Monitor

Before you rotate the monitor, your monitor should be fully vertically extended ([Vertical Extension](#)) and fully tilted up to avoid hitting the bottom edge of the monitor.

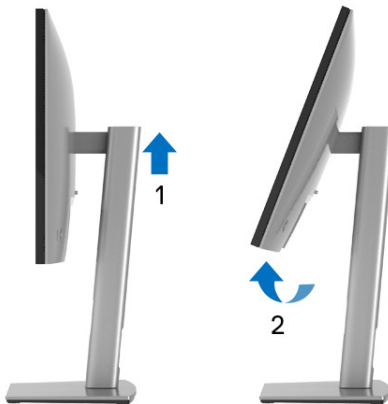



Rotate Clockwise



Rotate Counterclockwise



-  **NOTE:** To use the Display Rotation function (Landscape versus Portrait view) with your Dell computer, you require an updated graphics driver that is not included with this monitor. To download the graphics driver, go to www.dell.com/support and see the Download section for Video Drivers for latest driver updates.
-  **NOTE:** When in the Portrait View Mode, you may experience performance degradation in graphic-intensive applications (3D Gaming and etc.).



Adjusting the Rotation Display Settings of Your System

After you have rotated your monitor, you need to complete the procedure below to adjust the Rotation Display Settings of your system.

 **NOTE: If you are using the monitor with a non-Dell computer, you need to go the graphics driver website or your computer manufacturer website for information on rotating the 'contents' on your display.**

To adjust the Rotation Display Settings:



1. Right-click on the desktop and click **Properties**.
2. Select the **Settings** tab and click **Advanced**.
3. If you have an ATI graphics card, select the **Rotation** tab and set the preferred rotation.
4. If you have an nVidia graphics card, click the **nVidia** tab, in the left-hand column select **NVRotate**, and then select the preferred rotation.
5. If you have an Intel® graphics card, select the **Intel** graphics tab, click **Graphic Properties**, select the **Rotation** tab, and then set the preferred rotation.

 **NOTE: If you do not see the rotation option or it is not working correctly, go to www.dell.com/support and download the latest driver for your graphics card.**

 **NOTE: You can also refer to the [Rotation](#) function on your OSD to rotate your display.**



Removing the Monitor Stand

-  **NOTE:** To prevent scratches on the LCD screen when removing the stand, ensure that the monitor is placed on a soft, clean surface.
-  **NOTE:** The following instructions are applicable only for attaching the stand that was shipped with your monitor. If you are attaching a stand that you purchased from any other source, follow the set up instructions that were included with the stand.

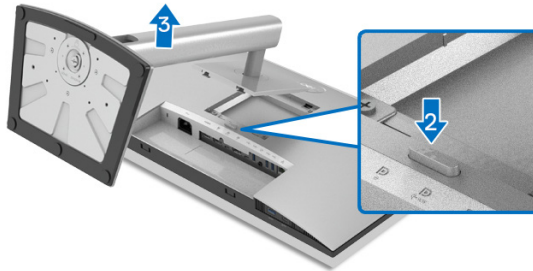

To remove the stand:

1. Place the monitor on a soft cloth or cushion.
2. Press and hold the stand release button.
3. Lift the stand up and away from the monitor.

VESA Wall Mounting (optional)

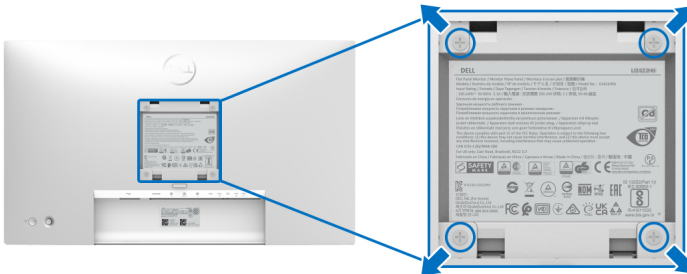

(Screw dimension: M4 x 10 mm).

Refer to the instructions that come with the VESA-compatible wall mounting kit.

1. Place the monitor panel on a soft cloth or cushion on a stable flat table.
2. Remove the stand. (See [Removing the Monitor Stand](#))



3. Use a Phillips crosshead screwdriver to remove the four screws securing the plastic cover.
4. Attach the mounting bracket from the wall mounting kit to the monitor.
5. Mount the monitor on the wall. For more information, see the documentation that shipped with the wall mounting kit.

 **NOTE: For use only with UL or CSA or GS-listed wall mount bracket with minimum weight or load bearing capacity of 14.08 kg (for U2422H/U2422HX) or 15.84 kg (for U2422HE).**



Operating the Monitor

Power On the Monitor

Press the Power Button to turn On the monitor.

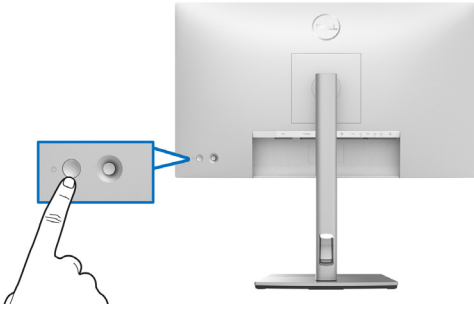

Using the Joystick Control

To modify the OSD adjustments using the Joystick control on the rear end of the monitor, do the following:

1. Press the Joystick button to launch the OSD Menu Launcher.
2. Move the Joystick **up/down/left/right** to toggle between the OSD menu options.

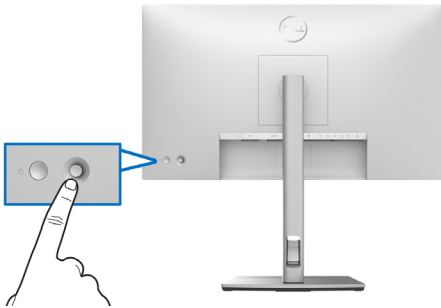

Joystick Functions

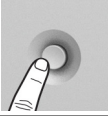
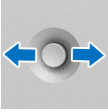
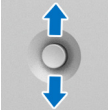
Function	Description
	Press Joystick to open the OSD Menu Launcher.
	<ul style="list-style-type: none">• For right and left navigation.• Move right to enter the submenu.• Move left to exit from the submenu.
	<ul style="list-style-type: none">• For up and down navigation.• Toggle between the menu items.• Increases (up) or decreases (down) the parameters of the selected menu item.

Using the Main Menu

Using the Menu Launcher

Press the Joystick to open the OSD Menu Launcher.

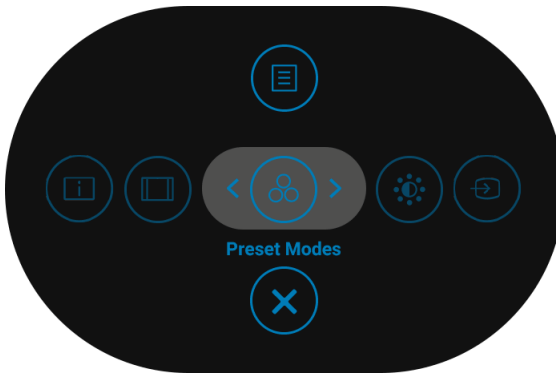







Menu Launcher



The following table describes the Menu Launcher functions:



Menu Launcher Details

Menu Launcher Icon	Description
 Main Menu	Opens the On-Screen Display (OSD). See OSD Menu Details .
 Display Info (Shortcut Key 1)	Displays the monitor's current status.
 Aspect Ratio (Shortcut Key 2)	Adjusts the aspect ratio of your screen.
 Preset Modes (Shortcut Key 3)	Allows you to choose from a list of preset color modes.
 Brightness/Contrast (Shortcut Key 4)	Select this icon to adjust the brightness and contrast level.
 Input Source (Shortcut Key 5)	<ul style="list-style-type: none">• Sets the Input Source.• Select Auto from Input Source menu to scan for available input sources.
 Exit	Exits from the OSD main menu.

 **NOTE: You can set your preferred Shortcut Key. See [Personalize](#) for details.**

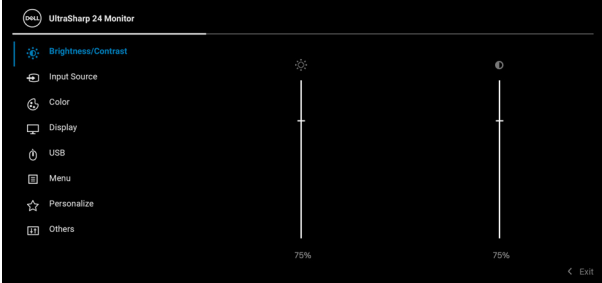

OSD Menu Details

Icon	Menu and Submenus	Description
	Brightness/Contrast	Activates Brightness/Contrast adjustment.
		
		
Brightness	Adjusts the luminance of the backlight. Toggle the Joystick up to increase the brightness and toggle the Joystick down to decrease the brightness (Range: 0 - 100).	
Contrast	Adjusts the Brightness first, and then adjust the Contrast only if further adjustment is necessary. Toggle the Joystick up to increase the contrast and toggle the Joystick down to decrease the contrast (Range: 0 - 100). The Contrast function adjusts the degree of difference between darkness and lightness on the monitor screen.	





Input Source

Selects between the different video signals that may be connected to your monitor.

For U2422H/U2422HX:

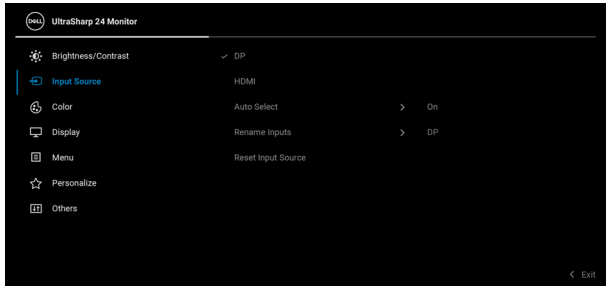

For U2422HE:

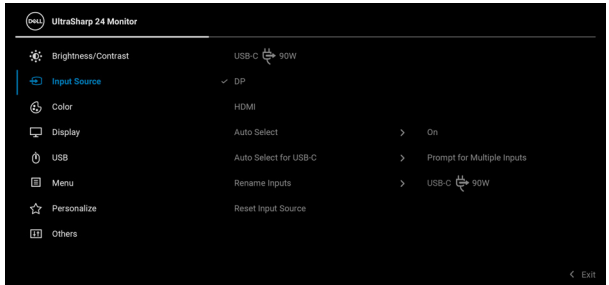

DP

Select the **DP** input when you are using the DisplayPort (DP) connector . Press the Joystick to confirm the selection.

HDMI

Select the **HDMI** input when you are using the HDMI connector . Press the Joystick to confirm the selection.



**USB-C ⚡ 90W
(U2422HE only)**

Select the **USB-C ⚡ 90W** input when you are using the USB-C connector . Press the Joystick to confirm the selection.

Auto Select

Allows you to scan for available input sources. The default is **On**.

**Auto Select for
USB-C
(U2422HE only)**

Allows you to set Auto Select for USB-C to:

- **Prompt for Multiple Inputs:** Always displays the **“Switch to USB-C Video Input”** message for you to choose whether to switch or not.
- **Yes:** Always switches to USB-C video input (without asking) when the USB-C cable is connected.
- **No:** Never automatically switches to USB-C video input when the USB-C cable is connected.

NOTE: **Auto Select for USB-C** is available only when **Auto Select** is on.

Rename Inputs

Allows you to select the input name for the selected input source. The options are **PC**, **PC 1**, **PC 2**, **Laptop**, **Laptop 1**, and **Laptop 2**.

NOTE: Input names in warning messages and Display Info will not be changed.

**Reset Input
Source**

Press the Joystick to reset all settings under the **Input Source** menu to the factory preset values.

Color

Adjusts the color setting mode.

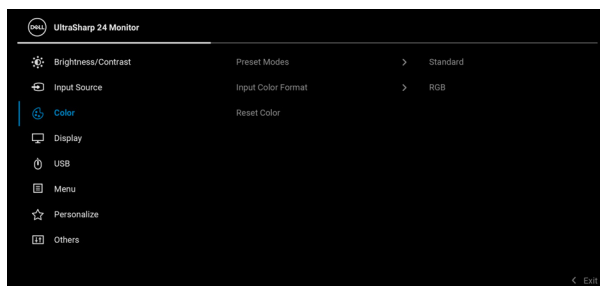

Preset Modes Allows you to choose from a list of preset color modes.

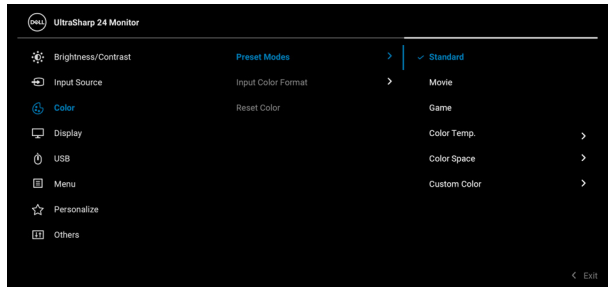

- **Standard:** Loads the monitor's default color settings. This is the default preset mode.
- **Movie:** Loads color settings ideal for movies.
- **Game:** Loads color settings ideal for most gaming applications.
- **Color Temp.:** Allows you to select the color temperature: 5000K, 5700K, 6500K, 7500K, 9300K, and 10000K. Press the Joystick to confirm the selection.
- **Color Space:** Allows you to select the color space **sRGB** or **Rec. 709**.
- **Custom Color:** Allows you to manually adjust the color settings.

Toggle the Joystick **up** or **down** to adjust the RGB color values and create your own preset color mode.



Input Color Format

Allows you to set the video input mode to:

- **RGB**: Select this option if your monitor is connected to a computer or a media player that supports RGB output.
- **YCbCr**: Select this option if your media player supports only YCbCr output.

Press the Joystick to confirm the selection.

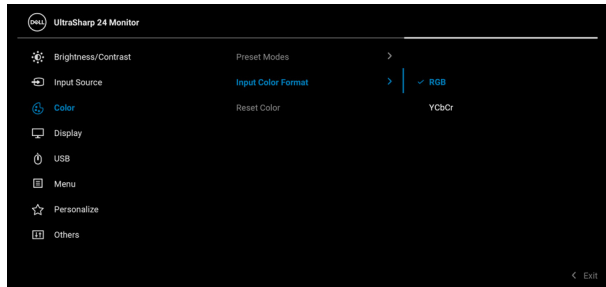

Hue

Shifts the color of the video image to green or purple. This is used to adjust the desired flesh tone color. Toggle the Joystick **up** or **down** to adjust the hue from '0' to '100'.

NOTE: Hue adjustment is available only when you select **Movie** or **Game** preset mode.

Saturation

Adjusts the color saturation of the video image. Toggle the Joystick **up** or **down** to adjust the saturation from '0' to '100'.

NOTE: Saturation adjustment is available only when you select **Movie** or **Game** preset mode.

Reset Color

Press the Joystick to reset all settings under the **Color** menu to the factory preset values.





Display

Use the **Display** menu to adjust images.



Aspect Ratio Adjusts the image ratio to **16:9**, **Auto Resize**, **4:3**, or **1:1**.

Sharpness This feature can make the image look sharper or softer.

Toggle the Joystick **up** or **down** to adjust the sharpness from '0' to '100'.

Response Time Allows you to set the **Response Time** to **Normal** or **Fast**.

MST DP Multi Stream Transport, select **On** to enable MST (DP Out), select **Off** to disable the MST function. See [Connecting the Monitor for DP Multi-Stream Transport \(MST\) Function](#) and [Connecting the Monitor for USB-C Multi-Stream Transport \(MST\) Function \(U2422HE Only\)](#) for details.

NOTE: When DP or USB-C to USB-C cable (U2422HE only) and DP downstream cable are connected, the OSD will set **MST to On** automatically. This action will only be done once after **Factory Reset** or **Display Reset**.



Multi-Monitor Sync

Allows multiple monitors that are Daisy Chained via DP to synchronize following OSD settings in the background: **Brightness, Contrast, Preset Modes, Color Temp., Custom Color, Hue, Saturation, Response Time, and Sharpness.** See [Multi-Monitor Sync \(MMS\)](#) for details.

Reset Display

Press the Joystick to reset all settings under the **Display** menu to the factory preset values.



USB (U2422HE only)

Allows you to assign the USB upstream port for the input signals (DP, HDMI), thus the monitor's USB downstream port can be used by the current input signals when you connect a computer to either one of the upstream ports. When you use only one upstream port, the connected upstream port is active.



NOTE: To prevent data damage or loss, before changing USB upstream ports, make sure that no USB storage devices are in use by the computer connected to the monitor's USB downstream port.





Menu

Select this option to adjust the settings of the OSD, such as, the languages of the OSD, the amount of time the menu remains on screen, and so on.

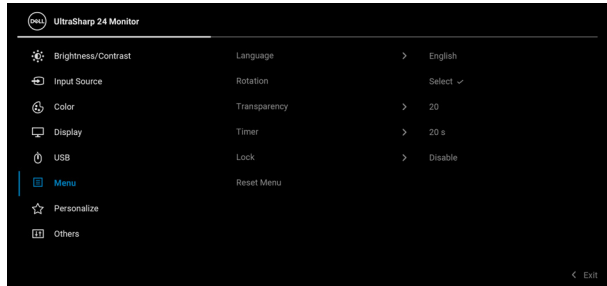

Language

Sets the OSD display to one of the eight languages (English, Spanish, French, German, Brazilian Portuguese, Russian, Simplified Chinese, or Japanese).

Rotation

Press the Joystick to rotate the OSD and the screen by 0/90/180/270 degrees.

You can adjust the menu according to your display rotation.

Transparency

Select this option to change the menu transparency by toggling the Joystick **up** or **down** (Range: 0 - 100).

Timer

Sets the length of time the OSD will remain active after the last time you pressed a button.

Toggle the Joystick **up** or **down** to adjust the slider in 1 second increments, from 5 to 60 seconds.



Lock

With the control buttons on the monitor locked, you can prevent people from accessing the controls. It also prevents accidental activation in multiple monitors side-by-side setup.

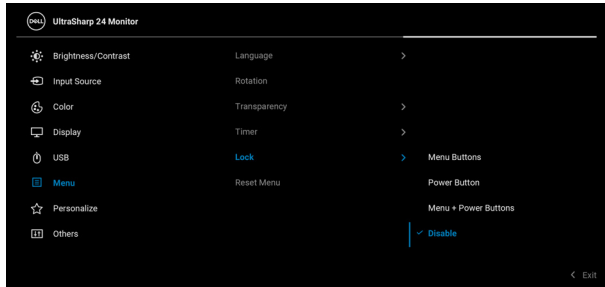

- **Menu Buttons:** All Joystick functions are locked and not accessible by the user.
- **Power Button:** Only the **Power Button** is locked and not accessible by the user.
- **Menu + Power Buttons:** Both the Joystick & the **Power Button** are locked and not accessible by the user.

The default setting is **Disable**.

Alternative Lock Method [for Menu/function buttons]: You can also press and hold the Joystick to the **up** or **down** or **left** or **right** for 4 seconds to set the lock options.

NOTE: To unlock the button(s), press and hold the Joystick to the **up** or **down** or **left** or **right** for 4 seconds.

Reset Menu

Press the Joystick to reset all settings under the **Menu** menu to the factory preset values.





Personalize

For U2422H/U2422HX:

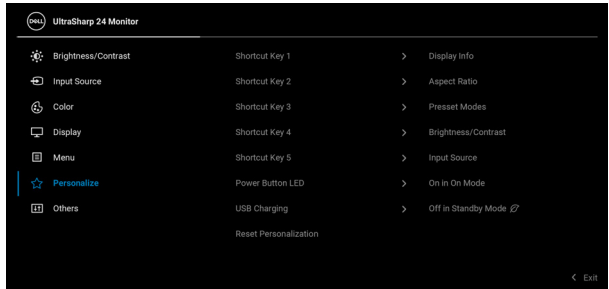

For U2422HE:

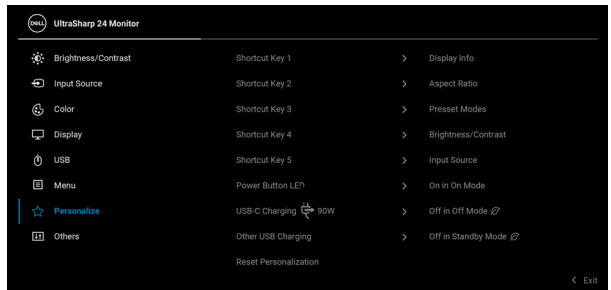

Shortcut Key 1

Shortcut Key 2

Shortcut Key 3

Shortcut Key 4

Shortcut Key 5

Power Button LED

USB Charging (U2422H/U2422HX only)

Allows you to choose a feature from **Preset Modes**, **Brightness/Contrast**, **Input Source**, **Aspect Ratio**, **Rotation**, or **Display Info** and set it as a shortcut key.

Allows you to set the power LED indicator on or off to save energy.

Allows you to enable or disable USB Type-A and USB-C Downstream Ports charging function during monitor standby mode.



**USB-C
Charging
@90W
(U2422HE only)**

Allows you to enable or disable the **Always On USB-C Charging** function during monitor Off mode.

When this function is enabled, you will be able to charge your notebook or mobile devices through the USB-C cable even when the monitor is powered off.

**Other USB
Charging
(U2422HE only)**

Allows you to enable or disable USB Type-A and USB-C Downstream Ports charging function during monitor standby mode.

When this function is enabled, you will be able to charge your mobile devices through the USB-A cable even when the monitor is powered off.

NOTE: This option is only available when the USB-C (Upstream Port) cable is unplugged. If the USB-C cable is connected, **Other USB Charging** follows the USB host power status and the option is not accessible.

**Reset
Personalization**

Press the Joystick to reset all settings under the **Personalize** menu to the factory preset values.

Others

Select this option to adjust the OSD settings, such as **DDC/CI**, **LCD Conditioning**, and so on.

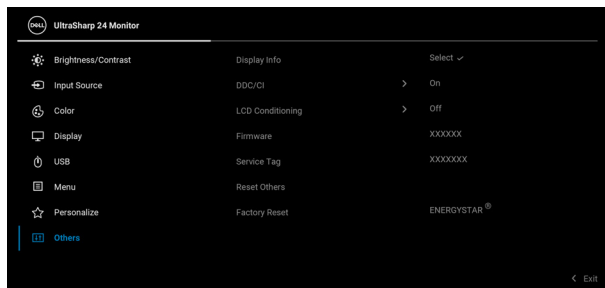

Display Info

Press the Joystick to display the monitor's current settings.

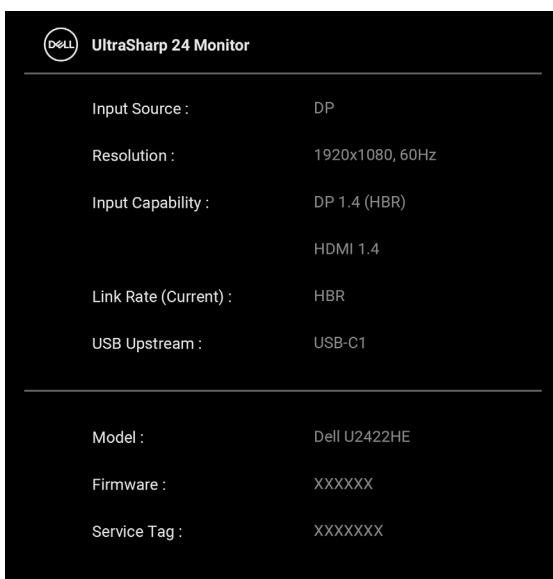

DDC/CI

DDC/CI (Display Data Channel/Command Interface) allows your monitor parameters (brightness, color balance, and etc.) to be adjustable via the software on your computer. You can disable this feature by selecting **Off**. Enable this feature for best user experience and optimum performance of your monitor.

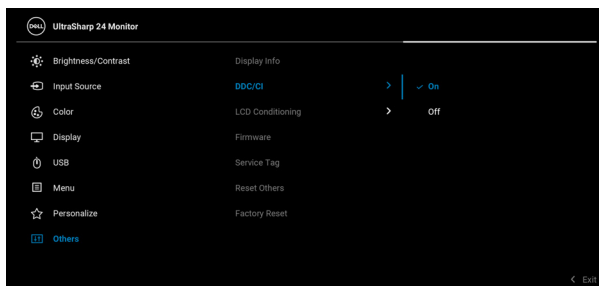

LCD Conditioning

Helps reduce minor cases of image retention. Depending on the degree of image retention, the program may take some time to run. You can enable this feature by selecting **On**.

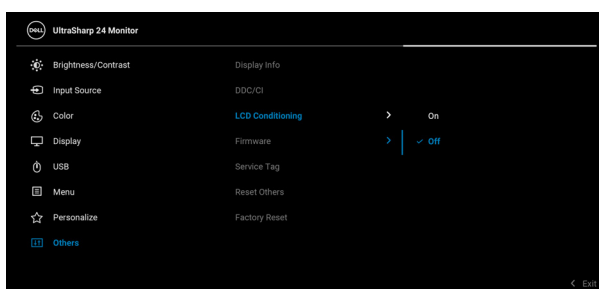

Firmware Displays the firmware version of your monitor.

Service Tag Displays the service tag of your monitor. This string is required when you look for phone support, check your warranty status, update drivers on Dell's website, etc.

Reset Others Press the Joystick to reset all settings under the **Others** menu to the factory preset values.

Factory Reset Restore all preset values to the factory default settings. These are also the settings for ENERGY STAR® tests.

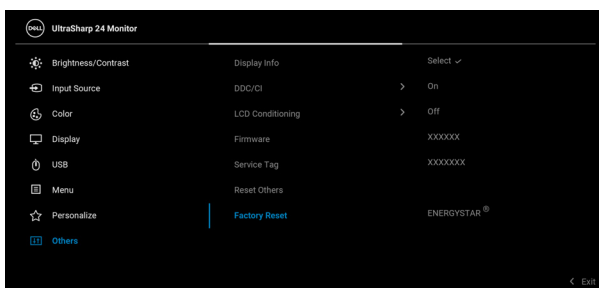

OSD Messages

Initial Setup

When **Factory Reset** is selected, the following message appears:



When **Yes** is selected, the following message appears.

For U2422H/U2422HX:

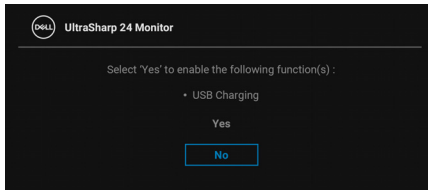

For U2422HE:

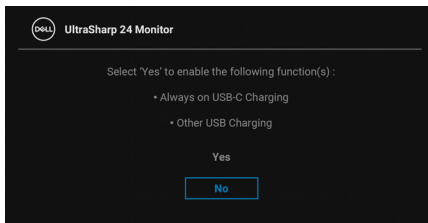

OSD Warning Messages

When the monitor does not support a particular resolution mode, you will see the following message:

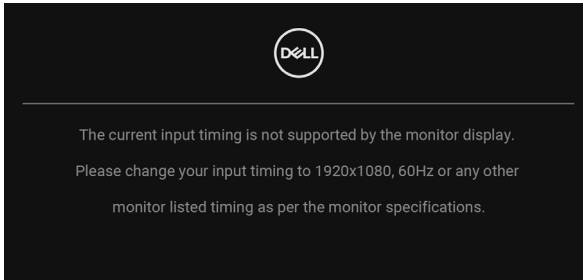

This means that the monitor cannot synchronize with the signal that it is receiving from the computer. See [Monitor Specifications](#) for the Horizontal and Vertical frequency ranges addressable by this monitor. Recommended mode is 1920 x 1080.

 **NOTE: The message may be slightly different according to the connected input signal.**

You will see the following message before the **DDC/CI** function is disabled:

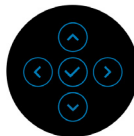
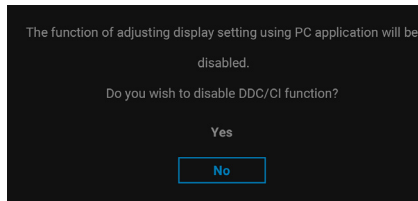

When you adjust the **Brightness** level for the first time, the following message appears:

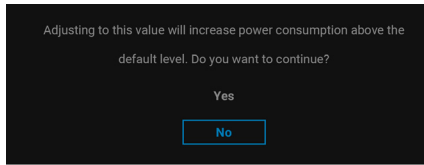

NOTE: If **Yes** is selected, the message will not appear next time you intend to change the **Brightness** setting.

When you change the default setting of power saving features for the first time, such as **USB-C Charging ⚡ 90W (U2422HE only)**, **Other USB Charging (U2422HE only)**, or **USB Charging (U2422H/U2422HX only)**, the following message appears:

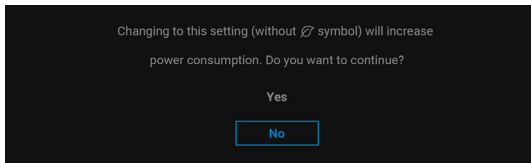

NOTE: If you select **Yes** for any one of the features mentioned above, the message will not appear next time you intend to change the settings of these features. When you perform a factory reset, the message will appear again.



You will see the following message before the **Lock** function is activated:

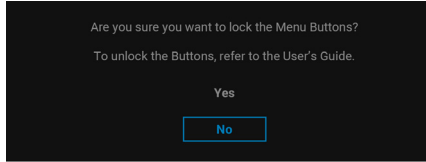

 **NOTE: The message may be slightly different according to the selected settings.**

When the monitor goes into Standby mode, the following message appears:

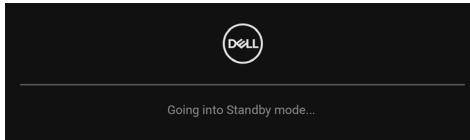

Activate the computer and wake up the monitor to gain access to the [OSD](#).

 **NOTE: The message may be slightly different according to the connected input signal.**

The OSD functions only in the normal operation mode. If you press any button other than the **Power Button** during the Standby mode, the following message will appear depending on the selected input:

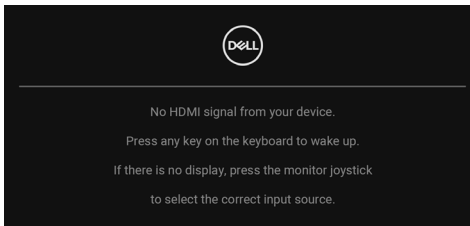

 **NOTE: The message may be slightly different according to the connected input signal.**



Activate the computer and the monitor to gain access to the [OSD](#).

 **NOTE: The message may be slightly different according to the connected input signal.**

If either USB-C (U2422HE only), DisplayPort, or HDMI input is selected and the corresponding cable is not connected, a floating dialog box as shown below appears.

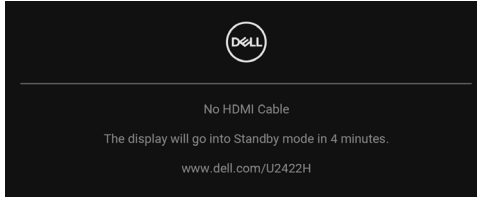

 **NOTE: The message may be slightly different according to the connected input signal.**

For U2422HE, When the monitor is under DP/HDMI input and a USB-C cable is connected to a notebook that supports DP Alternate Mode, if [Auto Select for USB-C \(U2422HE only\)](#) is enabled, the following message appears:

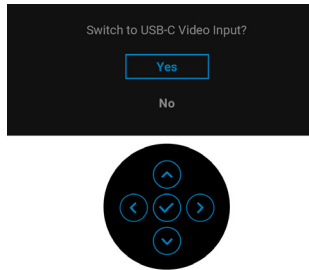

See [Troubleshooting](#) for more information.



Setting the KVM Switch (U2422HE Only)

The built-in KVM switch allows you to control up to 2 computers from a single set of keyboard and mouse connected to the monitor.

- a. When connecting **HDMI + USB-C2** to computer 1 and **DP + USB-C1** to computer 2:

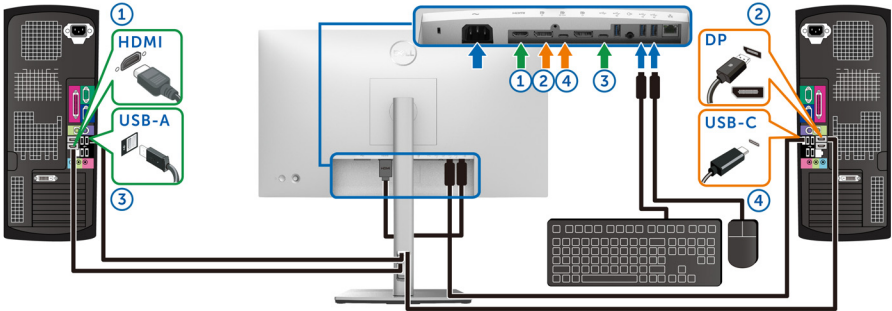

NOTE: The USB Type-C connection currently supports only data transfer.

Ensure that **USB** for **HDMI** is assigned to **USB-C2** and **DP** is assigned to **USB-C1** to 90W.



b. When connecting **HDMI + USB-C2** to computer 1 and **USB-C 1 + 90W** to computer 2:

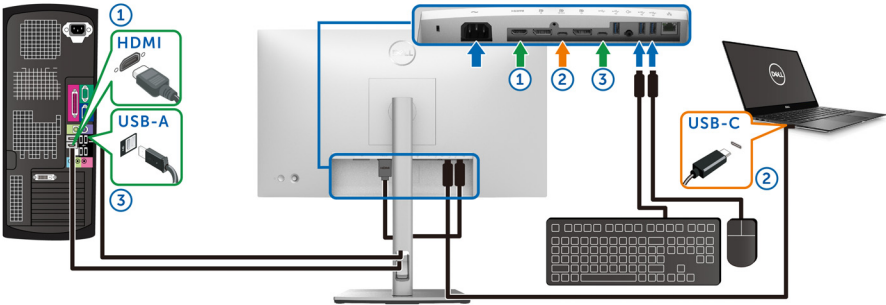

NOTE: The USB-C connection currently supports video and data transfer.

Ensure that **USB** for **HDMI** is assigned to **USB-C2**.

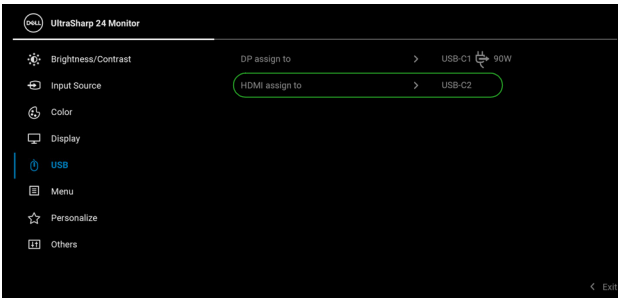

NOTE: As the USB-C upstream port **DP 90W** supports the DisplayPort Alternate Mode, there is no need to set USB for USB-C **90W**.

NOTE: When connecting to different video input sources not shown above, follow the same method to make correct settings for USB to pair the ports.



Setting the Auto KVM (U2422HE Only)

You can follow below instructions to set up Auto KVM for your monitor:

1. Ensure that **Auto Select** is **On** and **Auto Select for USB-C** is **Yes**.

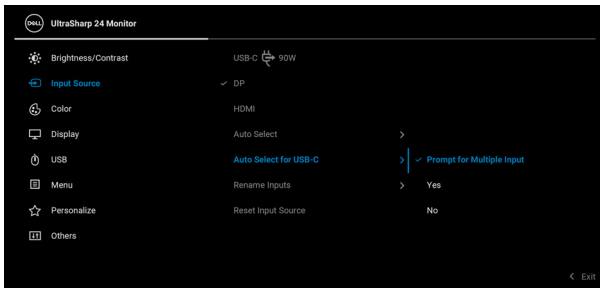
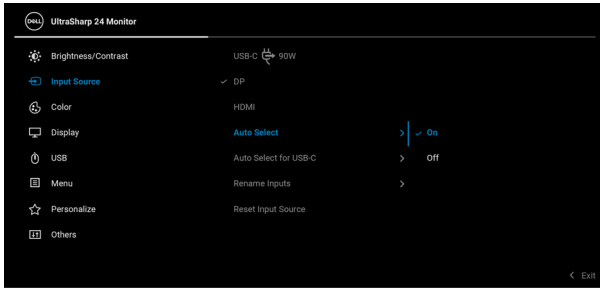

2. Ensure that the USB ports and the video inputs are paired accordingly.



NOTE: For USB-C 90W connection, there is no further setting required.

Setting the Maximum Resolution

To set the maximum resolution for the monitor:

In Windows[®] 7, Windows[®] 8, and Windows[®] 8.1:

1. For Windows[®] 8 and Windows[®] 8.1 only, select the Desktop tile to switch to classic desktop.
2. Right-click on the desktop and click **Screen Resolution**.
3. Click the dropdown list of the **Screen Resolution** and select **1920 x 1080**.
4. Click **OK**.

In Windows[®] 10:

1. Right-click on the desktop and click **Display settings**.
2. Click **Advanced display settings**.
3. Click the dropdown list of **Resolution** and select **1920 x 1080**.
4. Click **Apply**.

If you do not see 1920 x 1080 as an option, you may need to update your graphics driver. Depending on your computer, complete one of the following procedures:

If you have a Dell desktop or portable computer:

- Go to <http://www.dell.com/support>, enter your service tag, and download the latest driver for your graphics card.



If you are using a non-Dell computer (portable or desktop):

- Go to the support site for your computer and download the latest graphic drivers.
- Go to your graphics card website and download the latest graphic drivers.

Multi-Monitor Sync (MMS)

Multi-Monitor Sync allows multiple monitors that are daisy chained via DisplayPort to synchronize a predefined group of OSD settings in the background.

An OSD option, **Multi-Monitor Sync**, in the Display Menu allows user to enable/disable syncing.

 **NOTE: MMS does not support with HDMI port.**

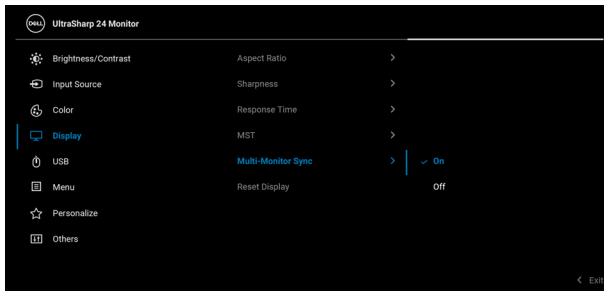

When Monitor 1 MST is set to **On** for the first time (For example, during connection of Monitor 2), MMS will be set to **On**.



NOTE: The following OSD settings will be synchronized: **Brightness, Contrast, Preset Modes, Color Temp., Custom Color (RGB Gain), Hue (Movie, Game mode), Saturation (Movie, Game mode), Response Time, and Sharpness.**

Setting Multi-Monitor Sync (MMS)

During initial power on or connection of a new monitor, user setting synchronization only starts if MMS is **On**. All monitors should synchronize settings from Monitor 1.



After the first synchronization, subsequent syncing is driven by changes to the predefined group of OSD settings from any node in the chain. Any node may initiate the changes downstream and upstream.

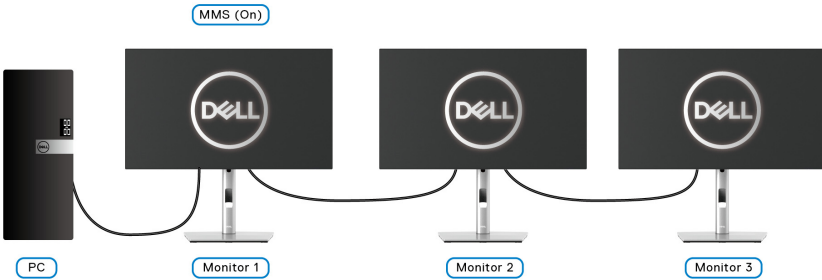

Troubleshooting

⚠ WARNING: Before you begin any of the procedures in this section, follow the [Safety instructions](#).

Self-test

Your monitor provides a self-test feature that allows you to check whether your monitor is functioning properly. If your monitor and computer are properly connected but the monitor screen remains dark, run the monitor self-test by performing the following steps:

1. Turn off both your computer and the monitor.
2. Unplug the video cable from the back of the computer.
3. Turn on the monitor.

The floating dialog box should appear on-screen (against a black background), if the monitor cannot sense a video signal and is working correctly. While in self-test mode, the power LED remains white. Also, depending upon the selected input, one of the dialogs shown below will continuously scroll through the screen.

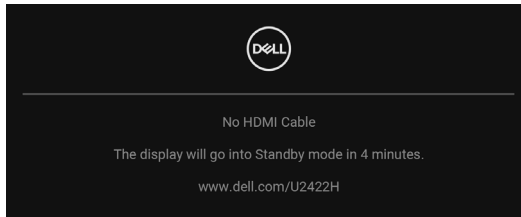

✎ NOTE: The message may be slightly different according to the connected input signal.

4. This box also appears during normal system operation, if the video cable becomes disconnected or damaged.
5. Turn Off your monitor and reconnect the video cable; then turn On both your computer and the monitor.

If your monitor screen remains blank after you use the previous procedure, check your video controller and computer, because your monitor is functioning properly.



Lock/Unlock Menu and Built-in Diagnostics

Locking the Power and Joystick Buttons

You can lock the Joystick and Power buttons to prevent access to the OSD menu and/or power off the monitor.

To lock the buttons:

1. Toggle and hold the Joystick to the **up** or **down** or **left** or **right** for about 4 seconds until a pop menu appears.

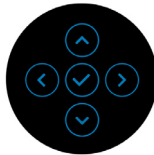
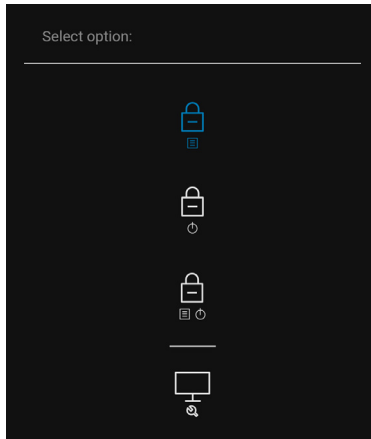

2. Select one of the following options:

- **Menu Buttons:** All Joystick functions are locked and not accessible by the user.
- **Power Buttons:** Only the **Power Button** is locked and not accessible by the user.
- **Menu + Power Buttons:** Both the Joystick & the **Power Button** are locked and not accessible by the user.

To unlock the button(s), press and hold the Joystick to the **up** or **down** or **left** or **right** for 4 seconds. Select the **Unlock** icon to unlock the button(s).



Built-in Diagnostics

Your monitor has a built-in diagnostic tool that helps you determine if the screen abnormality you are experiencing is an inherent problem with your monitor, or with your computer and video card.

To run the built-in diagnostics:

1. Ensure that the screen is clean (no dust particles on the surface of the screen).
2. Toggle and hold the Joystick to the **up** or **down** or **left** or **right** for about 4 seconds until a pop menu appears.

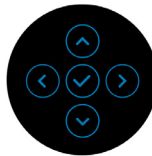
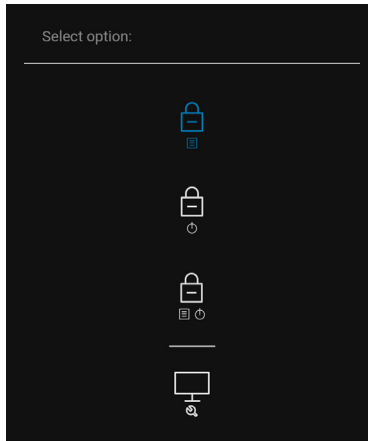

3. Toggle the Joystick to highlight the Diagnostics icon, then press the Joystick, and a gray screen appears.

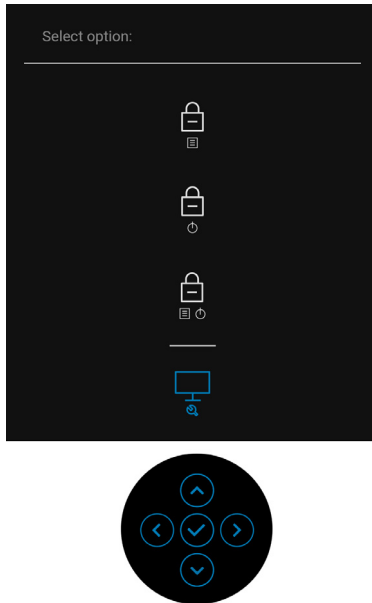

4. Carefully inspect the screen for abnormalities.
5. Toggle the Joystick **up**. The color of the screen changes to red.
6. Inspect the display for any abnormalities.
7. Repeat steps 5 and 6 to inspect the display in green, blue, black, white and text screens.

The test is complete when the text screen appears. To exit, toggle the Joystick **up** again.



Always On USB-C Charging (U2422HE Only)

The monitor allows you to charge your notebook or mobile devices through the USB-C cable even when the monitor is powered off. See [USB-C Charging 90W \(U2422HE only\)](#) for more information.

Updating Monitor Firmware

You may verify your current firmware revision in [Firmware](#). If this is not available, go to the Dell download support site for the latest application installer (**Monitor Firmware Update Utility.exe**) and refer to the Firmware Update Instruction User's Guide: www.dell.com/U2422H, www.dell.com/U2422HX or www.dell.com/U2422HE.

Common Problems

The following table contains general information about common monitor problems you might encounter and the possible solutions:

Common Symptoms	What You Experience	Possible Solutions
No Video/Power LED off	No picture	<ul style="list-style-type: none">• Ensure that the video cable connecting the monitor and the computer is properly connected and secure.• Verify that the power outlet is functioning properly using any other electrical equipment.• Ensure that the Power Button is pressed fully.• Ensure that the correct input source is selected in the Input Source menu.



No Video/Power LED on	No picture or no brightness	<ul style="list-style-type: none"> · Increase brightness & contrast controls via OSD. · Perform monitor self-test feature check. · Check for bent or broken pins in the video cable connector. · Run the built-in diagnostics. · Ensure that the correct input source is selected in the Input Source menu.
Poor Focus	Picture is fuzzy, blurry, or ghosting	<ul style="list-style-type: none"> · Eliminate video extension cables. · Reset the monitor to factory settings. · Change the video resolution to the correct aspect ratio.
Shaky/Jittery Video	Wavy picture or fine movement	<ul style="list-style-type: none"> · Reset the monitor to factory settings. · Check environmental factors. · Relocate the monitor and test in another room.
Missing Pixels	LCD screen has spots	<ul style="list-style-type: none"> · Cycle power On-Off. · Pixel that is permanently Off is a natural defect that can occur in LCD technology. · For more information on Dell Monitor Quality and Pixel Policy, see Dell Support site at: http://www.dell.com/pixelguidelines.
Stuck-on Pixels	LCD screen has bright spots	<ul style="list-style-type: none"> · Cycle power On-Off. · Pixel that is permanently off is a natural defect that can occur in LCD technology. · For more information on Dell Monitor Quality and Pixel Policy, see Dell Support site at: http://www.dell.com/pixelguidelines.



Brightness Problems	Picture too dim or too bright	<ul style="list-style-type: none"> Reset the monitor to factory settings. Adjust brightness & contrast controls via OSD.
Geometric Distortion	Screen not centered correctly	<ul style="list-style-type: none"> Reset the monitor to factory settings.
Horizontal/Vertical Lines	Screen has one or more lines	<ul style="list-style-type: none"> Reset the monitor to factory settings. Perform monitor self-test feature check and determine if these lines are also in self-test mode. Check for bent or broken pins in the video cable connector. Run the built-in diagnostics.
Synchronization Problems	Screen is scrambled or appears torn	<ul style="list-style-type: none"> Reset the monitor to factory settings. Perform monitor self-test feature check to determine if the scrambled screen appears in self-test mode. Check for bent or broken pins in the video cable connector. Restart the computer in the safe mode.
Safety Related Issues	Visible signs of smoke or sparks	<ul style="list-style-type: none"> Do not perform any troubleshooting steps. Contact Dell immediately.
Intermittent Problems	Monitor malfunctions on & off	<ul style="list-style-type: none"> Ensure that the video cable connecting the monitor to the computer is connected properly and is secure. Reset the monitor to factory settings. Perform monitor self-test feature check to determine if the intermittent problem occurs in self-test mode.





Missing Color	Picture missing color	<ul style="list-style-type: none"> • Perform monitor self-test feature check. • Ensure that the video cable connecting the monitor to the computer is connected properly and is secure. • Check for bent or broken pins in the video cable connector.
Wrong Color	Picture color not good	<ul style="list-style-type: none"> • Try different Preset Modes in Color settings OSD. Adjust the R/G/B value in Custom Color in Color settings OSD. • Change the Input Color Format to RGB or YCbCr/YPbPr in the Color settings OSD. • Run the built-in diagnostics.
Image retention from a static image left on the monitor for a long period of time	Faint shadow from the static image displayed appears on the screen	<ul style="list-style-type: none"> • Set the screen to turn off after a few minutes of screen idle time. These can be adjusted in Windows Power Options or Mac Energy Saver setting. • Alternatively, use a dynamically changing screensaver.



Product Specific Problems



Common Symptoms	What You Experience	Possible Solutions
Screen image is too small	Image is centered on screen, but does not fill entire viewing area	<ul style="list-style-type: none">• Check the Aspect Ratio setting in the Display menu OSD.• Reset the monitor to factory settings.
Cannot adjust the monitor with the buttons on the front panel	OSD does not appear on the screen	<ul style="list-style-type: none">• Turn Off the monitor, unplug the power cord, plug it back, and then turn On the monitor.• Check whether the OSD menu is locked. If yes, press and hold the Menu/function button next to the Power Button for 4 seconds to unlock (for more information, see Lock).
No Input Signal when user controls are pressed	No picture, the LED light is white	<ul style="list-style-type: none">• Check the signal source. Ensure the computer is not in the standby mode by moving the mouse or pressing any key on the keyboard.• Check whether the signal cable is plugged in properly. Re-plug the signal cable if necessary.• Reset the computer or video player.
The picture does not fill the entire screen	The picture cannot fill the height or width of the screen	<ul style="list-style-type: none">• Due to different video formats (aspect ratio) of DVDs, the monitor may display in full screen.• Run the built-in diagnostics.



<p>No video at HDMI HDMI /DisplayPort port </p>	<p>When connected to some dongle/docking device at the port, there is no video when unplugging/plugging the Thunderbolt cable from the notebook</p>	<ul style="list-style-type: none"> · Unplug the HDMI/DisplayPort cable from dongle/docking device, then plug the docking Thunderbolt cable to the notebook. Plug the HDMI/DisplayPort cable 7 seconds later.
<p>No video at USB-C port  (U2422HE only)</p>	<p>When connected to some dongle/docking device at the port, there is no video when unplugging/plugging the Thunderbolt cable from the notebook</p>	<ul style="list-style-type: none"> · Unplug the USB-C cable from dongle/docking device, then plug the docking Thunderbolt cable to the notebook. Plug the USB-C cable 7 seconds later.
<p>No network connection (U2422HE only)</p>	<p>Network dropped or intermittent</p>	<ul style="list-style-type: none"> · Check to ensure USB-C Prioritization is set to High Data Speed. · Do not turn Off the display during network connection.



Universal Serial Bus (USB) Specific Problems

Common Symptoms	What You Experience	Possible Solutions
USB interface is not working	USB peripherals are not working	<ul style="list-style-type: none"> • Check that your monitor is turned On. • Reconnect the upstream cable to your computer. • Reconnect the USB peripherals (downstream connector). • Switch Off and then turn On the monitor again. • Reboot the computer. • Some USB devices like external portable HDD require higher electric current; connect the device directly to the computer system.
USB-C port  does not supply power (U2422HE only)	USB peripherals can not be charged	<ul style="list-style-type: none"> • Check that the connected device is compliant with the USB-C specification. The USB-C port  supports USB 3.2 Gen2 and an output of 90 W. • Check that you use the USB-C cable shipped with your monitor.
Super speed USB 10 Gbps (USB 3.2 Gen2) interface is slow	Super speed USB 10 Gbps (USB 3.2 Gen2) peripherals working slowly or not working at all	<ul style="list-style-type: none"> • Check that your computer is super speed USB 10 Gbps (USB 3.2 Gen2)-capable. • Some computers have USB 3.2, USB 2.0 and USB 1.1 ports. Ensure that the correct USB port is used. • Reconnect the upstream cable to your computer. • Reconnect the USB peripherals (downstream connector). • Reboot the computer.



Wireless USB peripherals stop working when a USB 3.2 device is plugged in

Wireless USB peripherals responding slowly or only working as the distance between itself and its receiver decreases

- Increase the distance between the USB 3.2 peripherals and the wireless USB receiver.
 - Position your wireless USB receiver as close as possible to the wireless USB peripherals.
 - Use a USB-extender cable to position the wireless USB receiver as far away as possible from the USB 3.2 port.
-



Appendix

WARNING: Safety instructions

 **WARNING: Use of controls, adjustments, or procedures other than those specified in this documentation may result in exposure to shock, electrical hazards, and/or mechanical hazards.**

For information on safety instructions, see Safety, Environmental, and Regulatory Information (SERI).

FCC Notices (U.S. only) and Other Regulatory Information

For FCC notices and other regulatory information, see the regulatory compliance website located at www.dell.com/regulatory_compliance.

Contact Dell

For customers in the United States, call 800-WWW-DELL (800-999-3355).

 **NOTE: If you do not have an active Internet connection, you can find contact information on your purchase invoice, packing slip, bill, or Dell product catalog.**

Dell provides several online and telephone-based support and service options. Availability varies by country and product, and some services may not be available in your area.

- Online technical assistance — www.dell.com/support/monitors
- Contacting Dell — www.dell.com/contactdell

EU Product Database for Energy Label and Product Information Sheet

U2422H: <https://eprel.ec.europa.eu/qr/414164>

U2422H WOST: <https://eprel.ec.europa.eu/qr/419925>

U2422HE: <https://eprel.ec.europa.eu/qr/414161>

