



Touchscreen display

Safety & Recommendations

[English](#)

[Deutsch](#)

[Nederlands](#)

[Français](#)

[Español](#)

Table of contents

01 IMPORTANT INFORMATION	3
1.1 USE	3
1.2 EXEMPTIONS	4
02 SAFETY INSTRUCTIONS	4
2.1 SAFETY PRECAUTIONS	4
2.2 MOVING AND CARRYING NOTICE	5
2.3 INSTALLATION	5
2.4 WALLMOUNT SAFETY NOTICE	6
2.5 RECOMMENDED USE	7
2.6 CLEANING	8

IMPORTANT INFORMATION

1. IMPORTANT INFORMATION



WARNING:

TO PREVENT FIRE OR SHOCK HAZARDS, DO NOT EXPOSE THIS UNIT TO RAIN OR MOISTURE. ALSO, DO NOT USE THIS UNIT'S POLARIZED PLUG WITH AN EXTENSION CORD RECEPTACLE OR OTHER OUTLETS UNLESS THE PRONGS CAN BE FULLY INSERTED. REFRAIN FROM OPENING THE E-SCREENS HOUSING AS THERE ARE HIGH VOLTAGE COMPONENTS INSIDE.



CAUTION:

TO REDUCE THE RISK OF ELECTRIC SHOCK, MAKE SURE POWER CORD IS UNPLUGGED FROM WALL SOCKET. TO FULLY DISENGAGE THE POWER TO THE UNIT, PLEASE DISCONNECT THE POWER CORD FROM THE AC OUTLET. DO NOT REMOVE COVER (OR BACK). NO USER SERVICEABLE PARTS INSIDE. REFER SERVICING TO QUALIFIED SERVICE.



WARNING:

FOR CONTINUED SAFETY, DEVICES WITH CLASS I CONSTRUCTION SHALL BE CONNECTED TO A MAIN SOCKET OUTLET WITH A PROTECTIVE EARTHING CONNECTION.



WARNING:

THIS IS A CLASS A PRODUCT MEANT TO BE USED IN PROFESSIONAL ENVIRONMENTS. - THIS PRODUCT MUST NOT BE USED IN RESIDENTIAL AREAS.

1.1. USE

- Transport the product upright with proper packaging. Avoid placing the product face up or down. Handle with care!
- Do not send a static (non-moving) image to the e-screen, it may cause image 'burn-in' or image retention.
- "Burn in" and/or image retention is not covered under warranty.
- Make sure to change the image on the e-screen periodically. It is recommended to turn off the e-screen for at least 6 hours after 16 hours of usage in a 24-hour period to help avoid image retention.

SAFETY INSTRUCTIONS

1.2. EXEMPTIONS

- This product isn't warranted for any damage caused by natural disaster (such as earthquake, thunder, etc.), fire, acts by third parties, accidents, owner's intentional misuse and fault, or use in other improper conditions.
- This product isn't warranted for incidental damages (such as profit loss or interruption in business, modification or erasure of record data, etc.) caused by use or inability to use of this product.
- This product isn't warranted for any damage caused by inappropriate operation, or from not following the user manual.
- This product isn't warranted for any damage caused by misuse or malfunction through simultaneous use of this product and the connected equipment or software.
- This product isn't warranted for any damage caused by neglect of the installation instructions.
- This product isn't warranted for any damage caused by improper installation.
- This product isn't warranted for any damage caused by disassembly, modification or repair by non-authorized service centers or people.

2. SAFETY INSTRUCTIONS

Before using this e-screen, please read this user manual thoroughly to help protect against property damage and to ensure your personal safety and the safety of others.

- Read and follow all instructions and safety-warnings found in this manual.
- For installation or adjustment, please follow the instructions in this manual and refer all servicing to qualified service personnel.

2.1 SAFETY PRECAUTIONS

If smoke or a peculiar smell comes from the e-Screen, remove the power plug from the outlet immediately. Failure to do so may result in fire or electrical shock.

Contact your dealer for inspection.

If the e-Screen has been turned on but there is no picture, remove the power plug from the outlet immediately. Failure to do so may result in fire or electrical shock.

Contact your dealer for inspection.

If water is spilled or objects are dropped inside the e-Screen, remove the power plug from the outlet immediately. Failure to do so may result in fire or electrical shock.

Contact your dealer for inspection.

If the e-Screen is dropped or the e-screen's housing is damaged, remove the power plug from the outlet immediately. Failure to do so may result in fire or electrical shock.

Contact your dealer for inspection.

If the power cord or plug is damaged or becomes hot, turn off the main power switch of the e-Screen, make sure the power plug has cooled down and remove the power plug from the outlet.

If the e-Screen is still used in this condition, it may cause fire or electrical shock. Contact your dealer for replacement.

SAFETY INSTRUCTIONS

2.2 MOVING AND CARRYING NOTICE

Moving the product:

Moving the product requires at least four people. Attempting to move the product with fewer people may result in damage to the display or in serious injury of the people handling the screen. When moving a display in its shipping carton, lift the carton using the white handles.



Carrying the product:

This product is heavy; please follow proper lifting techniques, as pictured below. Failure to do so may cause injury.



2.3 INSTALLATION

Don't install in a high-temperature environment.

If the e-screen is used in high-temperatures or in direct sunlight, it may cause the housing of the product or other parts to become distorted or damaged, resulting in overheating or electrical shock.

Don't install in a high-humidity environment.

This may cause overheating or electrical shock.

Don't install near any heat sources such as radiators, heat registers, stoves, or other apparatus that produce heat.

This may cause fire or electrical shock.

Don't overload outlets or cables beyond electrical capacity. Don't use extension cords as it may cause fire or electrical shock.

Don't insert the power plug into an outlet other than 100~240V AC.

This may cause fire or electrical shock.

- Don't use a damaged power plug or worn outlet.
- Don't insert an improper power plug it may cause fire or electric shock.

Don't place the e-screen on an unstable shelf or surface. The e-screen may fall, causing injury. Please install on a horizontal, stable, level surface.

Don't place objects on the e-screen.

- If the e-screen is covered or the vents are blocked, the display could overheat and cause a fire.
- If objects or liquids get inside the e-screen, this may cause fire or electrical shock.
- Do not put heavy objects on the e-screen as they may fall, causing injury.
- Please keep a 10 cm minimum distance between e-screen, wall and/or other objects to ensure sufficient ventilation.

SAFETY INSTRUCTIONS

Don't move the e-screen when it is connected to the power cord and AV cables.

- When moving the e-screen, make sure to remove all cables first.
- When unpacking or carrying the e-screen, at least 4 people are needed. Make sure the e-screen is carried upright.
- Transport the e-screen upright. Avoid placing the e-screen face up or down.
- Handle the e-screen gently. Do not drop.

2.4 WALLMOUNT SAFETY NOTICE

1. Please make sure that the bracket is mounted on a solid surface.

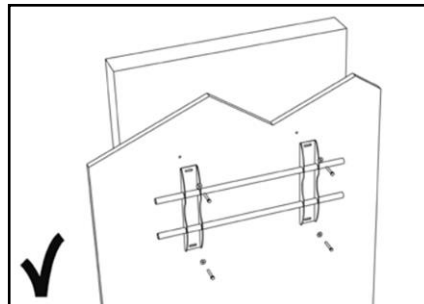
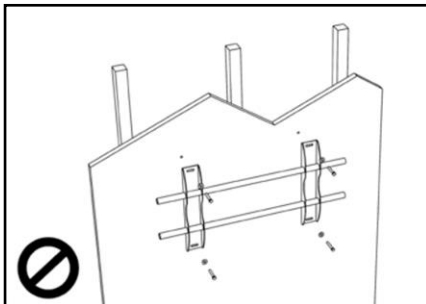

2. After mounting the screen, do not pull, push or shake the screen.

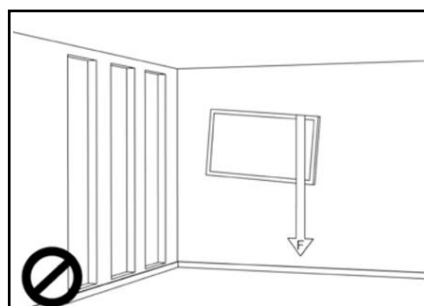
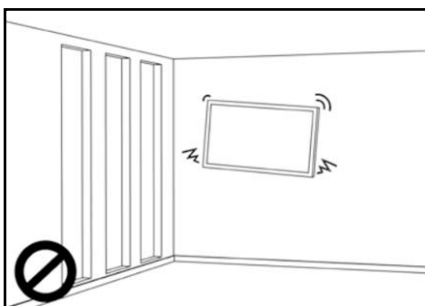

SAFETY INSTRUCTIONS

1. Do not install screens in direct sunlight, humid conditions, or high temperatures.

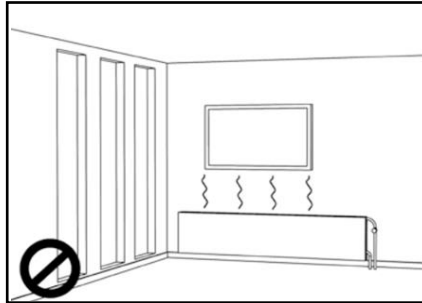
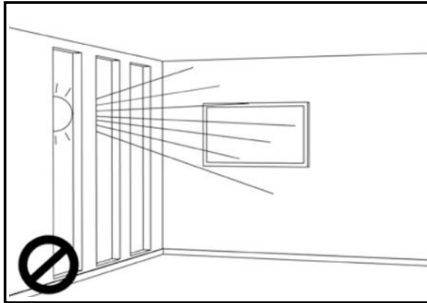

4.

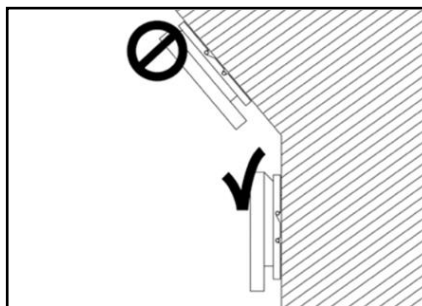
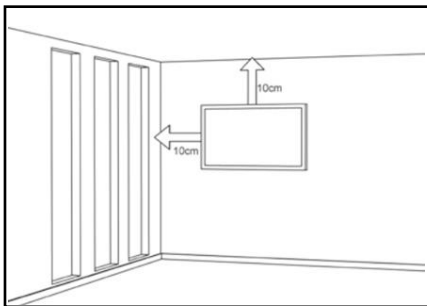

2.5 RECOMMENDED USE

If you encounter a problem during installation, please contact your supplier for assistance. Don't repair or open the e-screen by yourself. Failure to do so may result in fire or electrical shock.

Contact your dealer for inspection.

Protect and correctly use the power cord/plug.

- Don't pinch the power cord/plug between hard surfaces.
- Don't step on the power cord/plug.
- Before inserting the power plug into the wall outlet, connect the power cord to the display.
- Using an e-screen with a damaged or non-original power cord can damage the screen, cause fires or electrical shocks.

Using extension cords (not recommended)

If an extension cord must be used, ensure the voltage rating exceeds the max power consumption of the display. If the voltage rating is less than the display, it will cause the extension cord to overheat.

Do not operate the screen during thunder or lightning.

Remove the powerplug from the power outlet.

SAFETY INSTRUCTIONS

Don't use any kind of liquid on the e-screen.

- If liquid is spilled on the e-screen, remove the power plug from the wall socket and ask qualified service personnel to check the product.
- If liquid gets on e-screens glass plate, clean it with a dry and soft cloth immediately.
- Don't use any chemicals on the e-screen.
- If metal or liquids get into the e-screen, it may cause a fire or an electrical shock.

Don't install or remove the power plug with wet hands. This may cause an electrical shock.

If the e-screen will not be used for a long period of time, unplug the display. Preventing to do so may cause premature wear of electrical components or fire.

Handle the e-screen with care, prevent glass breakage.

- If the glass of the e-screen is broken, liquids may escape. Please don't touch the liquid.
- If these liquids come into contact with skin or eyes, immediately wash it away with clean water and consult a medical professional.

Precautions with the remote-control batteries

- Please only use approved AAA type batteries.
- Please be sure to insert batteries by matching the + and -.
- Don't recharge, heat, disassemble, short or throw batteries into a fire.
- Don't mix a new battery with a used one.
- Don't mix different types of batteries together (only use the specified type).

2.6 CLEANING

Remove the power plug from the power outlet before cleaning.

Failure to do so may result in electrical shock or damage.

Cleaning the surface of the e-screen

- When the surface of the e-screen becomes dirty, wipe the surface lightly with a soft clean cloth.
- If the surface requires additional cleaning, lightly moisten the cloth.
- Do not to let any kind of liquid enter the e-screen as it may cause electrical shock or damage.
- Do not clean the e-screen with alcohol, solvents or ammonia, as this could damage the e-screen.



Discover Professional display Product Content & Operation

[English](#)

Deutsch

Nederlands

Français

Español

Table of contents

01 PACKAGE CONTENT	11
1.1 UNPACKING	11
1.2 INCLUDED ACCESORIES	11
02 INSTALLATION	11
2.1 ENVIROMENT CONDITIONS	11
2.2 GENERAL OVERVIEW OF THE SCREEN	12
2.3 INPUT / OUTPUT CONNECTOR INFORMATION	13
2.4 REMOTE CONTROL	13
2.4.1 CHANGING THE REMOTE-CONTROL BATTERY	14
03 TURNING THE DISPLAY ON AND OFF	14
3.1 SETTINGS MENU	15
3.2 UPDATING THE SCREEN	18
04 TROUBLESHOOTING	18

PACKAGE CONTENT / INSTALLATION

1. PACKAGE CONTENT

1.1. UNPACKING

- The Professional Display is packed using cushions to protect the product during shipping.
- Before unpacking, prepare a stable, level, and clean surface near a wall outlet.
- Step 1: Place the box in an up-right stable position.
- Step 2: Remove the white handles and cut the banding
- Step 3: Smoothly lift the upper part of the box, this will reveal the Professional Display box content
- Step 4: Remove the top cushion and take the accessory bag out.
- Step 5: Extend the bag up and carefully cut the upper layer to unseal the Professional Display
- Step 6: Prepare your screen for installation, and then remove it from the box by lifting it.

1.2. INCLUDED ACCESORIES.

ITEMS
Power Cord 1.8m
Remote Control
Quick Set-Up Guide

2. INSTALLATION

2.1 ENVIROMENT CONDITIONS

When operating the screen, ambient room conditions should not exceed the following:

- Operating temperature: -5°C to 45°C (41°F to 104°F)
- Humidity: less than 90% RH (Max)

OVERVIEW

2.2 GENERAL OVERVIEW OF THE SCREEN

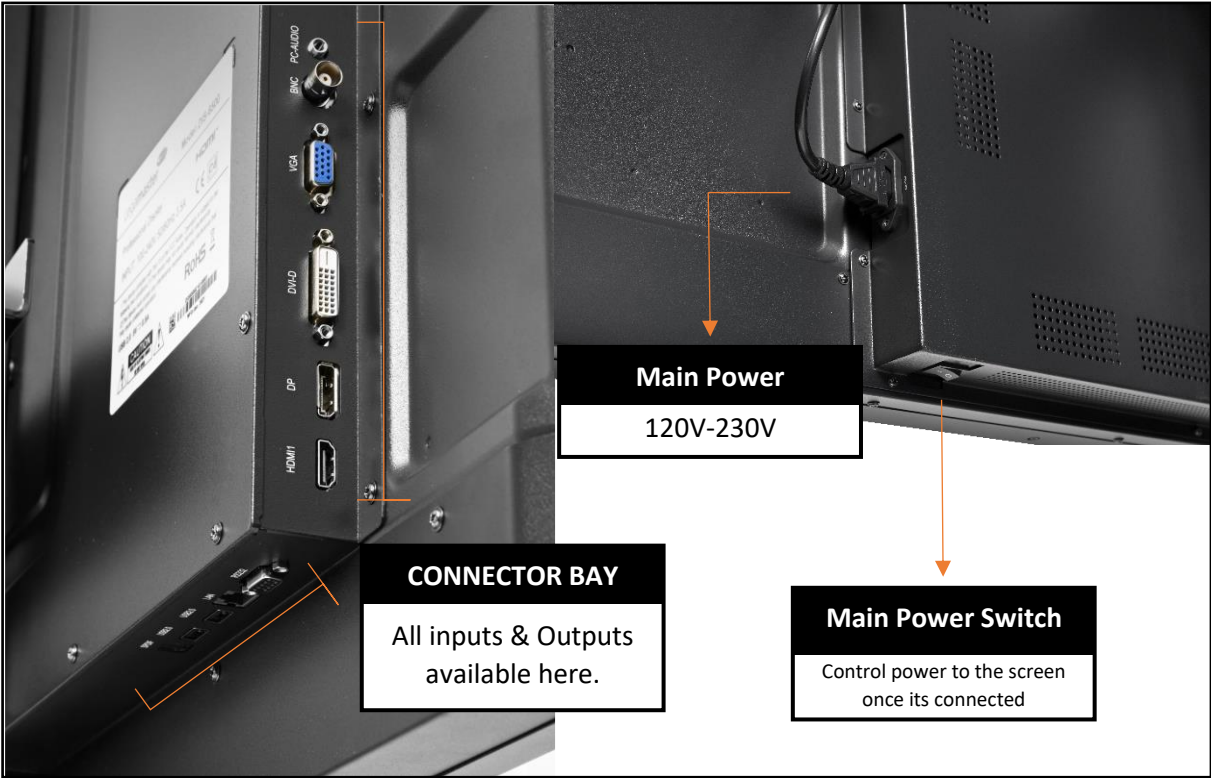
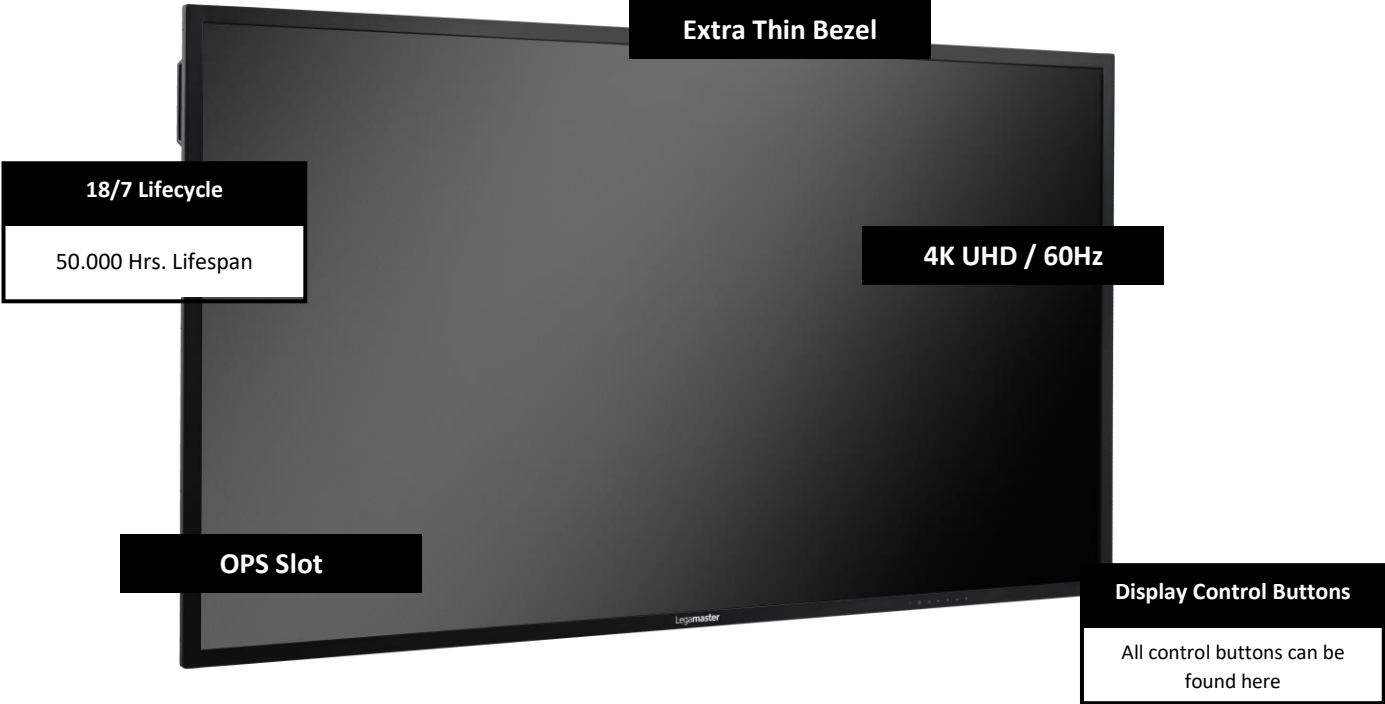

OVERVIEW



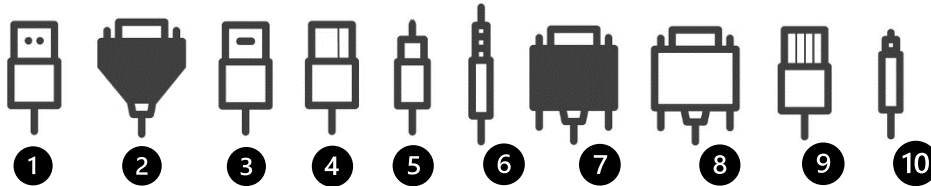









2.3 INPUT / OUTPUT CONNECTOR INFORMATION



- 1 USB-A 2.0 (x2)
- 2 VGA (1)
- 3 HDMI 2.0 (x1)
- 4 DP 1.2 (x1)
- 5 BNC (1)
- 6 Minijack 3,5 Stereo (x1 in) / (x1 out)
- 7 DVI-D (x1)
- 8 RS-232 (Serial)
- 9 RJ-45 (x1 IN) / RJ-45 (x1 Out)
- 10 SPDIF (Optical Audio)

2.4 REMOTE CONTROL



-  **Turn the display ON and OFF.**
-  **Source Selection** Displays the input selection screen to select from
-  **Navigation Buttons** Easy navigation wheel
-  **Select / Confirm:** Confirm your on screen selection
-  **Settings MENU** Direct access to the main settings MENU
-  **Home:** Head directly to the main home page
-  **Back / Return to previous MENU** Returns to the previously selection.
-  **OPS:** Direct Access to the OPS Input
-  **HDMI:** Direct Access to the HDMI Input
-  **Freeze:** Will Freeze the current picture frame.
-  **Volume Down** Lowers the audio volume.
-  **Mute:** Silence Audio output
-  **Volume Up** Raises the audio volume.

OVERVIEW / OPERATING THE SCREEN

2.4.1 CHANGING THE REMOTE-CONTROL BATTERY

1. Remove the battery cover:

On the backside of the remote-control, slide down the battery cover.

2. Insert batteries:

Use two AAA batteries and insert them according to the plus and minus indicators in the remote control.

3. Close the battery cover by sliding it back into place.

I. Discard batteries according to the local waste reduction and recovery regulations.

II. Do not keep used, empty batteries in the remote control. They can leak and result in damages to the remote control.

III. Only use batteries according to the instructions and regulations found in this manual and to the instructions and regulations set forth by the batterie's manufacturer.

About the remote control

- Do not drop, shake, or bump.
- Avoid moist conditions, liquids, high-temperatures and/or exposure to direct sunlight.
- Don't dismantle.

3. TURNING THE DISPLAY ON AND OFF

Please make sure the display is connected to an AC power-socket using the supplied power cable.

Set the AC-switch to "I". The Professional Display will start up, if not.

To switch the display on, push the power-button on the screen once, or push the power-button on the remote control.

To switch the display off, press the power-button on the screen, or push the power button on the remote control. The display will switch to stand-by mode.

To turn off power completely, turn the AC switch to "O" or disconnect the AC power cord from the power outlet.

OPERATING THE SCREEN

3.1 SETTINGS MENU

MAIN SETTINGS		LEVEL 1	VALUES	EXPLANATION	
Settings	Source	Source Switch	VGA	Switch your input to VGA	
			DP	Switch your input to DisplayPort	
			OPS	Switch your input to OPS	
			HDMI	Switch your input to HDMI	
			DVI	Switch your input to DVI	
			BNC	Switch your input to BNC	
		BootSource	VGA / HDMI / OPS / DP / DVI / BNC	Select a source to switch to when booting the screen	
		SourceLock	VGA / HDMI / OPS / DP / DVI / BNC	Select a Source to Block	
	AutoDetect		Automatically Switch to a new detected Source		
	Image	Image Setting	Image Mode	PC / Eye Pro / Standard / Lightness / Soft / User	Select Image Mode Configuration
			Brightness	1 - 100	Adjust your Brightness Setting
			Contrast	1 - 100	Adjust your Contrast Setting
			Tone	1 - 100	Adjust your Tone Setting
			Saturation	1 - 100	Adjust your Saturation Setting
			Sharpness	1 - 100	Adjust your Sharpness Setting
		Color Temperature Setting	Color Temp. Mode	Standard / Warm / Cold	Select Color Temperature Mode
			R Gain	0 - 255	Adjust Red Gain
			G Gain	0 - 255	Adjust Green Gain
			B Gain	0 - 255	Adjust Blue Gain
			R Offset	0 - 255	Adjust Red Offset
			G Offset	0 - 255	Adjust Green Offset
		B Offset	0 - 255	Adjust Blue Offset	
		Zoom Setting	Proportional Mode	16:9 / Dot by Dot / 4:3	Adjust Digital Zoom Settings
Advanced Setting		Backlight	1 - 100	Set Backlight Intensity	
	Color Range	Auto / 0 - 255 / 16 - 255	Select Color Range		
	Gamma	2.0 - 2.5	Set Gamma Configuration		
	HDR	Auto	HDR Mode		
	HDMI EDID	1.4	EDID Version		

OPERATING THE SCREEN

MAIN SETTINGS		LEVEL 1	VALUES		EXPLANATION
Settings	Sound	Volume	Mute	ON / OFF	Toggle Mute Option
			Volume	1 - 100	Adjust Volume Setting
		Balance	Sound Balance	1 - 100	Adjust Sound Balance
		Equalizer	HighPitch	1 - 100	Adjuts Sound Treble
			Bass	1 - 100	Adjutst Sound Bass
		Sound Output	Built In Device / External Device		Select Audio Output
		Listen Alone	ON / OFF		The display will go into stand by mode and sound will continue
		DVI Audio IN	DVI-D / Audio IN		Configure the Audio routing for DVI-D
	Wi-Fi	Wireless	Wi-Fi Switch	ON / OFF	Turn Wi-Fi ON/OFF
			Install Certificate		Install a Wi-Fi certificate
		Wired	Link	ON / OFF	Turn Wired Connection ON/OFF
			IP Setting	Automatic / Static IP	Configure IP Settings
			MAC Address		Current MAC Address
			IP Address		Current IP Address
			Proxy Setting	NO / Manual Control	Adjust Proxy congfiguration
		Wireless HotSpot	HotSpot Switch	ON / OFF	Turn Hotspot Functionality ON/OFF
			HotSpot Name		Set Hotspot Display Name
			Encryption Type	WPA2 PSK / NONE	Select Hostsoport Security
			Password	Show Password	Show Hotspot Password
			5 Ghz		Enable 5Ghz Band connection

OPERATING THE SCREEN

MAIN SETTINGS		LEVEL 1	VALUES	EXPLANATION			
Settings	User Configurations	Language	English / Nederlands / Español / France / Deutsch		Set Screen's Language		
		USB Media	USB Media Type	Video / Close / Image		AutoPlay a specific type of content	
			Image Play Duration	10 Seg.		Image Slideshow duration per image	
		Screen Saver & Display	Wallpaper			Set main Background	
			No Signal Picture			Set a No Signal image	
			Smart Clean Screen	ON / OFF		Enable/ Disable a Anti-burning mechanism	
			Clean Screen Time	0.5 Hr / 1 Hr / 2 Hrs			
		Control	RS-232	ON / OFF		Turn Serial Control ON/OFF	
			HDMI CEC	ON / OFF		Turn CEC ON/OFF	
		Power Control	Network Wake-Up	ON / OFF		Turn Network Wake Up ON/OFF	
			No Signal Automatic Shutdown	Close / 5 min. / 15 min. / 30 min.		Shutdown after thee selected time.	
		Remote Control & Buttons	Remote Lock	ON / OFF		Turn Remote Lock ON/OFF	
			Key Lock	ON / OFF		Turn Key Lock ON/OFF	
		Applicatoin Management	App Permissions			Modify App Permissions	
			Downloaded Apps	Clear Data / Clear Cache / Force Stop		Downloaded Apps Adminsitration	
			System Apps	Clear Data / Clear Cache / Force Stop		System Apps Administration	
		System Update	Firmware Upgrade (USB)			Upgrade Firmware Version	
		Reset	Confirmation Prompt			Reset Screen to default Values	
		Date & Time	Time And Date	Automatic Date & Time	ON / OFF		Turn Automatic Date & Time ON/OFF
				Set Date			Set internal Date
	Set Time			Set Internal Time			
	Time Zone			Select Time Zone			
	24-Hour			ON / OFF		Turn 24-Hour Mode ON/OFF	
	Timer ShutDown		Timer ShutDown	ON / OFF		Turn Timer Shutdown ON/OFF	
			Off Time			Set Off Time	

OPERATING THE SCREEN

MAIN SETTINGS		LEVEL 1	VALUES	EXPLANATION
Settings	Information	Signal Information	Current Source	Current Signal Information Displayed
			Current Resolution	Current Resolution Information Displayed
			Line Frequency	Current Line Frequency Displayed
			Field Frequency	Current Field Frequency Displayed
			Signal Color Gamut	Current Signal Color Gamut Displayed
		Monitor Information	Serial Number	Device's Serial number
			Run Time	Divece's Run Time
		System Information	Device Name	Device's Name Information
			Device Model	Device's Model Information
			Running Memory	Device's running memory information
			Storage Memory	Device's storage memory information
			Screen Resolution	Device's Screen resolution information
			Android Version	Device's Android version information
		System Version	Device's System version Information	

3.2 UPDATING THE SCREEN

Before first using the screen, please update it to the latest firmware version.

To update to the latest firmware version using a USB Drive, open the Setting Menu and navigate to User Configurations from this menu select the option System Update and then Firmware Upgrade (USB)

4. TROUBLESHOOTING

FOR FREQUENTLY ASKED QUESTIONS, PLEASE VISIT: FAQ.LEGAMASTER.COM