



OWNER'S MANUAL

LG UltraGear™

Gaming Monitor

(LED Monitor*)

* LG LED Monitor applies LCD screen with LED backlights.

Please read this manual carefully before operating your set and retain it for future reference.

27GP950
27GP95B

www.lg.com

Copyright © 2021 LG Electronics Inc. All Rights Reserved.

TABLE OF CONTENTS

LICENSE.....3

OPEN SOURCE SOFTWARE NOTICE INFORMATION4

ASSEMBLING AND PREPARING 4

- Supported Drivers and Software 5
- Product and Button Description..... 5
 - How to Use the Joystick Button
 - How to Use the Lighting Button
- Moving and Lifting the Monitor..... 7
 - Installing on a Table
 - Adjusting the Stand Height
 - Adjusting the Angle
 - Pivot Feature
 - Tidying up Cables
 - Using the Kensington Lock
 - Installing the Wall Mount Plate
 - Installing on the Wall

USING THE MONITOR..... 16

- Connecting to a PC..... 16
 - HDMI Connection
 - DisplayPort Connection
- Connecting AV Devices..... 17
 - HDMI Connection
- Connecting Peripherals..... 18
 - USB Device connection
 - Connecting Headphones

USER SETTINGS 19

- Activating the Main Menu 19
 - Main Menu Features
- User Settings 21
 - Menu Settings

TROUBLESHOOTING..... 33

PRODUCT SPECIFICATION 37

- Factory Support Mode..... 39
- HDMI Timing (Video)..... 40
- Power LED 41
- Beep Guide..... 42

LICENSE

Each model has different licenses. Visit www.lg.com for more information on the license.



The terms HDMI and HDMI High-Definition Multimedia Interface, and the HDMI Logo are trademarks or registered trademarks of HDMI Licensing Administrator, Inc.



The SuperSpeed USB Trident logo is a registered trademark of USB Implementers Forum, Inc.



VESA, VESA logo, DisplayPort compliance logo and DisplayPort compliance logo for dual-mode source devices are all registered trademarks of the Video Electronics Standards Association.



MaxxAudio and additional MAXX trademarks are trademarks and/or registered trademarks of Waves Audio Ltd.

OPEN SOURCE SOFTWARE NOTICE INFORMATION

To obtain the source code under GPL, LGPL, MPL, and other open source licenses, that is contained in this product, please visit <http://opensource.lge.com>.

In addition to the source code, all referred license terms, warranty disclaimers and copyright notices are available for download.

LG Electronics will also provide open source code to you on CD-ROM for a charge covering the cost of performing such distribution (such as the cost of media, shipping, and handling) upon email request to opensource@lge.com.

This offer is valid for a period of three years after our last shipment of this product.

This offer is valid to anyone in receipt of this information.

ASSEMBLING AND PREPARING

CAUTION

- Always use genuine LG components to ensure safety and product performance.
- The product warranty will not cover damage or injury caused by the use of unauthorized components.
- It is recommended that use the supplied components.
- If you use generic cables not certified by LG, the screen may not display or there may be image noises.
- Illustrations in this document represent typical procedures, so they may look different from the actual product.
- Do not apply foreign substances (oils, lubricants, etc.) to the screw parts when assembling the product. (Doing so may damage the product.)

- Applying excessive force when tightening screws may cause damage to the monitor. Damage caused in this way will not be covered by the product warranty.
- Do not carry the monitor upside down by just holding the base. This may cause the monitor to fall off the stand and could result in personal injury.
- When lifting or moving the monitor, do not touch the monitor screen. The force applied to the monitor screen may cause damage to it.
- For wave pattern on appearance, unlike the general method of coating, it's applied to added glittering material in raw material. With no peeled-off appearance, it has good durability. Please use it with confidence because there is no problem in using the product at all.

NOTE

- The components may look different from those illustrated here.
- Without prior notice, all product information and specifications contained in this manual are subject to change to improve the performance of the product.
- To purchase optional accessories, visit an electronics store or an online shopping site, or contact the retailer from where you purchased the product.
- The power cord provided may differ depending upon the region.

Supported Drivers and Software

You can download and install the latest version from the LGE website (www.lg.com).

Drivers and Software	Installation Priority
Monitor Driver	Recommended
OnScreen Control	Recommended
LG UltraGear™ Control Center	Optional
LG Calibration Studio	Optional



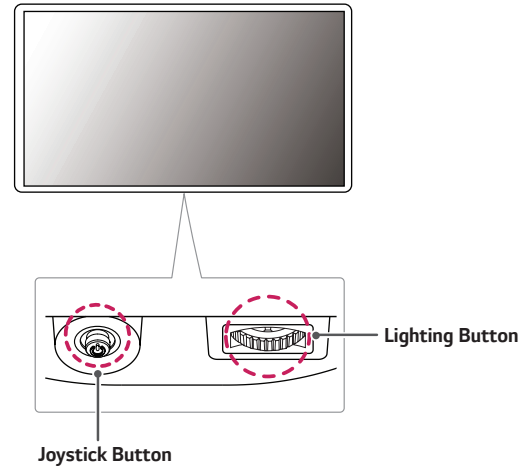

Product and Button Description



How to Use the Joystick Button

You can easily control the functions of the monitor by pressing the joystick button or moving it left/right/up/down with your finger.



Basic Functions

		Power on	Press the joystick button once with your finger to turn on the monitor.
		Power off	Press and hold the joystick button once with your finger to turn off the monitor.
		Volume control	You can control the volume by moving the joystick button left/right.

How to Use the Lighting Button

You can easily control the functions of the monitor by pressing the lighting button or moving it left/right with your finger.

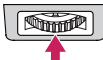
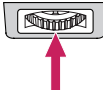
Basic Functions

	When Lighting is Off	When Lighting is On
	Press the lighting button once with your finger to turn on the lighting on the back of the monitor.	You can adjust the color by pressing the light button.
	Press and hold the lighting button once with your finger to turn on the lighting on the back of the monitor.	Press and hold the lighting button once with your finger to turn off the lighting on the back of the monitor.
	Not functional	You can control the lighting brightness by moving the lighting button left/right.

NOTE

- The joystick and lighting button are located at the bottom of the monitor.
- The Lighting function for the back of the monitor is available even when the monitor is in power saving mode or when its screen is off. (Settings > General > Lighting Option > Keep Lighting Status)
- Lighting LED is not for illumination purposes, and Please be aware that change in this setting component may increase energy consumption of this monitor.

Moving and Lifting the Monitor

When moving or lifting the monitor, follow these instructions to prevent the monitor from being scratched or damaged and to ensure safe transportation, regardless of its shape or size.

- Place the monitor in the original box or packing material before attempting to move it.
- Before moving or lifting the monitor, disconnect the power cord and all other cables.
- Hold the bottom and side of the monitor frame firmly. Do not hold the panel itself.

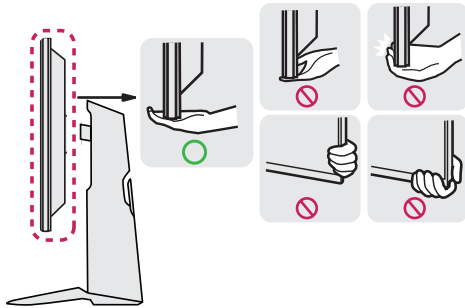

- When holding the monitor, the screen should face away from you to prevent it from being scratched.
- When transporting the monitor, do not expose the monitor to shock or excessive vibration.
- When moving the monitor, keep it upright and never turn the monitor on its side or tilt it sideways.

CAUTION

- Avoid touching the monitor screen as much as possible.
 - This may result in damage to the screen or some of the pixels used to create images.

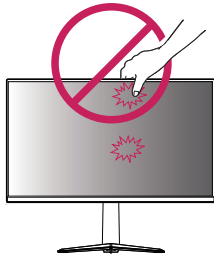

- If you use the monitor panel without the stand base, its joystick button may cause the monitor to become unstable and fall, resulting in damage to the monitor or human injury. In addition, this may cause the joystick button to malfunction.

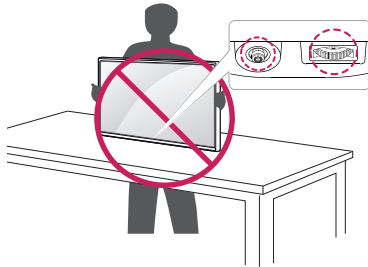

Installing on a Table

- Lift the monitor and place it on the table in an upright position. Place the monitor at least 100 mm (3.94 inches) away from the wall to ensure sufficient ventilation.

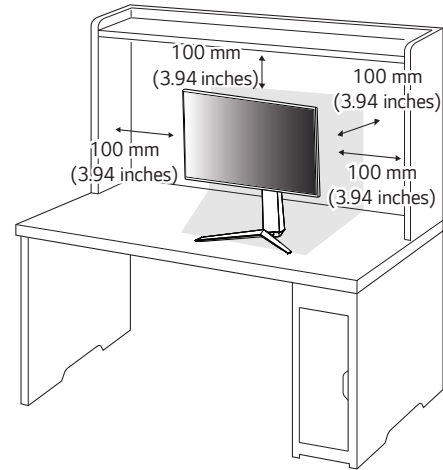

**CAUTION**

- Unplug the power cord before moving or installing the monitor. There is risk of electric shock.
- Make sure to use the power cord that is provided in the product package and connect it to a grounded power outlet.
- If you need another power cord, please contact your local dealer or the nearest retail store.

Adjusting the Stand Height

- 1 Place the monitor mounted on the stand base in an upright position.
- 2 Handle the monitor with both hands for safety.

Max. 110.0 mm (4.3 inches)

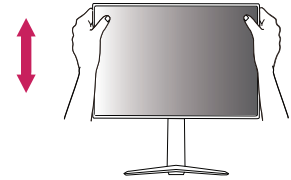
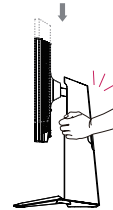
**WARNING**

- When adjusting the screen height, do not place your hand on the stand body to avoid injury to your fingers.

Adjusting the Angle

- 1 Place the monitor mounted on the stand base in an upright position.
 - 2 Adjust the angle of the screen.
- The angle of the screen can be adjusted forward or backward from -5° to 15° for a comfortable viewing experience.

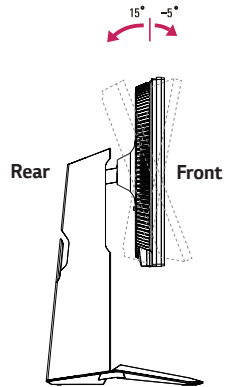

! WARNING

- To avoid injury to the fingers when adjusting the screen, do not hold the lower part of the monitor's frame as illustrated below.

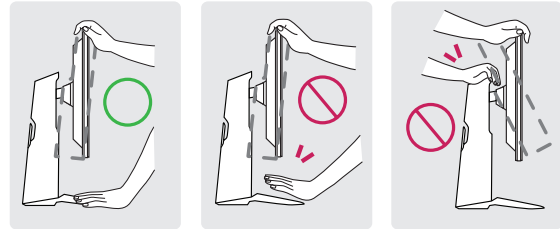

- Be careful not to touch or press the screen area when adjusting the angle of the monitor.

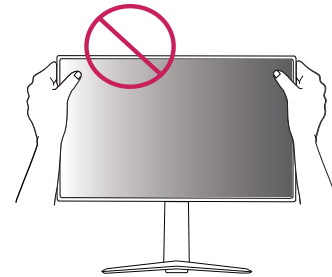

Pivot Feature

The pivot feature allows the monitor to rotate 90° clockwise.

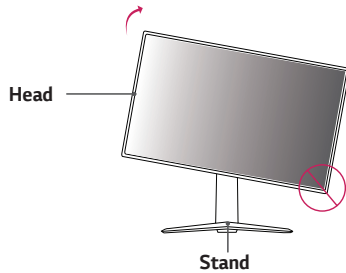

WARNING

- To avoid scratching the stand base, make sure that when rotating the monitor using the pivot feature, the stand does not make contact with the monitor.

- 1 Raise the monitor to the maximum height.

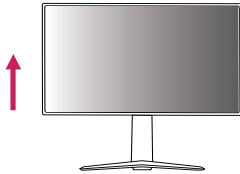

- 2 Adjust the angle of the monitor in the direction of the arrow as shown in the figure.

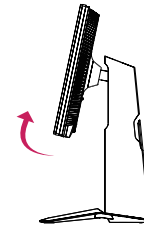

- 3 Rotate the monitor clockwise as shown in the figure.



- 4 Complete the installation by rotating the monitor 90° as shown below.



! **NOTE**

- Auto Pivot feature of the display is not supported.
- The screen can be rotated easily using the screen pivot shortcut key provided with your Windows operating system. Note that some Windows versions and some graphics card drivers may use different settings for the screen pivot key or may not support the pivot key at all.

Tidying up Cables

Arrange the cables using the cable holder as shown in the illustration.

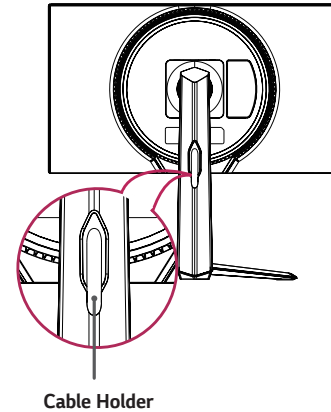
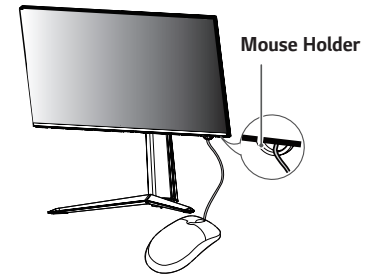

Using the Kensington Lock

The connector for the Kensington security system is located at the bottom of the monitor.

For more information on installation and usage, refer to the Kensington lock owner's manual or visit the website at <http://www.kensington.com>.

Connect the monitor to a table using the Kensington security system cable.

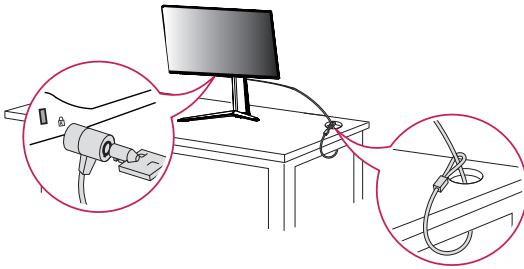

! NOTE

- The Kensington security system is optional. You can obtain optional accessories from most electronics stores.

Installing the Wall Mount Plate

This monitor meets the specifications for the wall mount plate or other compatible devices.

- 1 Place the screen face down. To protect the monitor panel (screen), cover the surface with a soft cloth or the monitor protection pad included in the product package.
- 2 Remove the four screws tightened on the back of the monitor.
- 3 Place the wall mount plate onto the monitor and align it with the screw holes.
- 4 Tighten the four screws using a screwdriver to fix the plate to the monitor.

! NOTE

- The wall mount plate is sold separately.
- For more information on installation, refer to the wall mount plate's installation guide.
- Be careful not to apply too much force while mounting the wall mount plate as it may cause damage to the screen.

Installing on the Wall

Install the monitor at least 100 mm (3.94 inches) away from the wall and leave about 100 mm (3.94 inches) of space at each side of the monitor to ensure sufficient ventilation. Detailed installation instructions can be obtained from your local retail store. Alternatively, please refer to the manual for how to install and set up a tilting wall mounting bracket.

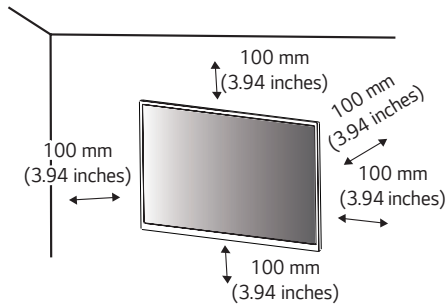

To install the monitor to a wall, attach a wall mounting bracket (optional) to the back of the monitor.

Make sure that the wall mounting bracket is securely fixed to the monitor and to the wall.

- 1 If you use screws longer than the standard length, it may damage the inside of the product.
- 2 A non-VESA standard screw may damage the product and cause the monitor to fall. LG Electronics is not liable for any accidents relating to the use of non-standard screws.

Wall Mount (mm)	100 x 100
Standard screw	M4 x L10
Number of screws	4
Wall Mount Plate (Optional)	LSW 149

NOTE

- Use the screws specified by VESA standards.
- The wall mount kit includes the installation guide and all necessary parts.
- The wall mounting bracket is optional. You can obtain optional accessories from your local dealer.
- The length of the screw may differ for each wall mounting bracket. Be sure to use the proper length.
- For more information, please refer to the user manual for the wall mounting bracket.

CAUTION

- Unplug the power cord before moving or installing the monitor to avoid electric shock.
- Installing the monitor on the ceiling or on a slanted wall may result in the monitor falling off, which could lead to injury. Use an authorized LG wall mount and contact the local dealer or qualified personnel.
- Applying excessive force when tightening screws may cause damage to the monitor. Damage caused in this way will not be covered by the product warranty.

- Use the wall mounting bracket and screws that conform to VESA standards. Damage caused by the use or misuse of inappropriate components will not be covered by the product warranty.
- When measured from the back of the monitor, the length of each installed screw must be 8 mm (0.3 inches) or less.

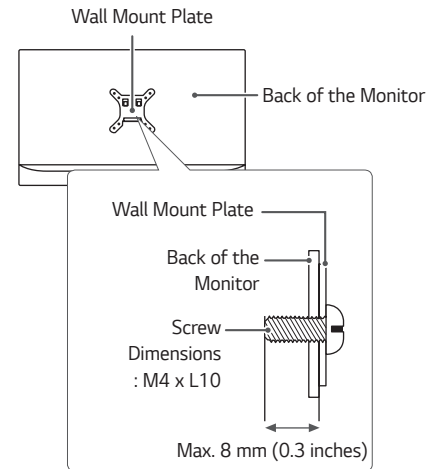

USING THE MONITOR

- Illustrations in this manual may differ from the actual product. Press the joystick button, go to **Settings** → **Input**, and then select the input option.



CAUTION

- Do not press the screen for a prolonged time. This may cause image distortion.
- Do not display a still image on the screen for a prolonged time. This may cause image retention. Use a screensaver if possible.



NOTE

- When connecting the power cord to the outlet, use a grounded (3-hole) power strip or a grounded power outlet.
- The monitor may flicker when turned on in an area where the temperature is low. This is normal.
- Sometimes red, green, or blue spots may appear on the screen. This is normal.

Connecting to a PC

- This monitor supports the *Plug and Play feature.
- * Plug and Play: A feature that allows you to add a device to your computer without having to reconfigure anything or install any manual drivers.

HDMI Connection

Transmits digital video and audio signals from your PC to the monitor.



CAUTION

- Using a DVI to HDMI / DP (DisplayPort) to HDMI cable may cause compatibility issues.
- Use a certified cable with the HDMI logo attached. If you do not use a certified HDMI cable, the screen may not display or a connection error may occur.
- Recommended HDMI cable types
 - Ultra High Speed HDMI®/™ cable

DisplayPort Connection

Transmits digital video and audio signals from your PC to the monitor.



NOTE

- There may be no video or audio output depending on the DP (DisplayPort) version of the PC.
- If you are using a Mini DisplayPort output graphics card, use a Mini DP to DP (Mini DisplayPort to DisplayPort) cable or gender that supports DisplayPort1.4. (sold separately)

Connecting AV Devices

HDMI Connection

HDMI transmits digital video and audio signals from your AV device to the monitor.



NOTE

- Using a DVI to HDMI / DP (DisplayPort) to HDMI cable may cause compatibility issues.
- Use a certified cable with the HDMI logo attached. If you do not use a certified HDMI cable, the screen may not display or a connection error may occur.
- Recommended HDMI cable types
 - Ultra High Speed HDMI®/™ cable

Connecting Peripherals

USB Device connection

The USB port on the product functions as a USB hub.

To use USB 3.0, connect the A-B type USB 3.0 cable of the product to the PC. Peripheral devices connected to the USB IN port can be controlled from the PC.

! NOTE

- It is recommended you install all Windows Updates to keep your Windows up-to-date before connecting to the product for use.
- Peripheral devices are sold separately.
- A keyboard, mouse, or USB device can be connected to the USB port.
- The charging speed may vary depending on the device.

! CAUTION

Cautions When Using a USB Device

- A USB device with an automatic recognition program installed, or that uses its own driver, may not be recognized.
- Some USB devices may not be supported or may not work properly.
- It is recommended to use a USB hub or hard disk drive with power supplied. (If the power supply is not adequate, the USB device may not be recognized properly.)

Connecting Headphones

Connect peripherals to the monitor via the headphones port.

! NOTE

- Peripheral devices are sold separately.
- If you use angled earphones, it may cause a problem with connecting another external device to the monitor. Therefore, it is recommended to use straight earphones.



Angled

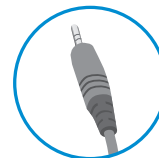

Straight
(Recommend)

- Depending on the audio settings of the PC and external device, headphones and speaker functions may be limited.

USER SETTINGS



! NOTE

- Your monitor's OSD (On Screen Display) may differ slightly from that shown in this manual.
- When **Beep Guide** is activated, pressing the joystick button will take you to **Settings** right away.

Activating the Main Menu

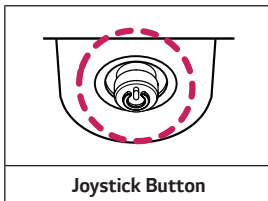
- 1 Press the joystick button on the bottom of the monitor.
- 2 Move the joystick up/down (▲ / ▼) and left/right (◀ / ▶) to set the options.
- 3 Press the joystick button once more to exit the main menu.



Button	Menu Status	Description
	Main menu disabled	Enables the main menu.
	Main menu enabled	Enters the Settings feature. (Holding down the button to turn off the monitor. You can turn off the monitor this way at any time, including when the OSD is on.)
	◀ Main menu disabled	Adjusts the monitor volume level.
	◀ Main menu enabled	Enters the Input feature.
	▶ Main menu disabled	Adjusts the monitor volume level.
	▶ Main menu enabled	Enters the Game Mode feature.
	▲ Main menu disabled	Enters the Accessibility menu.
	▲ Main menu enabled	Turns off the monitor.
	▼ Main menu disabled	Enters the Accessibility menu.
	▼ Main menu enabled	Exits the main menu.

Main Menu Features

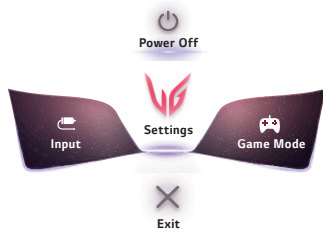

Main Menu	Description
Input	Sets input mode.
Power Off	Turns off the monitor.
Settings	Configures the screen settings.
Game Mode	Sets the game mode for gaming.
Exit	Exits the main menu.

User Settings

Menu Settings

- 1 To view the OSD menu, press the joystick button at the bottom of the monitor and then enter the **Settings**.
- 2 Configure the options by moving the joystick up/down/left/right.
- 3 To return to the upper menu or set other menu items, move the joystick to ◀ or pressing (⏻) it.
- 4 If you want to exit the OSD menu, move the joystick to ◀ until you exit.



Game Mode



Game Adjust



Picture Adjust



Input



General

Settings		Description
Game Mode		Changes the game mode to the one optimized for a given feature.
Game Adjust		Adjusts the Overclock, Adaptive-Sync/FreeSync Premium Pro, Black Stabilizer, Response Time, Crosshair, FPS Counter and Game Reset.
Picture Adjust		Adjusts the Brightness, Contrast, Sharpness, Gamma, Color Temp, R/G/B, Six Color, Black Level, Local Dimming, DFC and Picture Reset.
Input	Input List	Selects the input mode.
	Aspect Ratio	Adjusts the aspect ratio of the screen.
General		Sets Waves MaxxAudio®, Language, User-defined Key 1, User-defined Key 2, SMART ENERGY SAVING, Deep Sleep Mode, Lighting Option, Power LED, Automatic Standby, HDMI ULTRA HD Deep Color, DisplayPort Version, Buzzer, OSD Lock, Information and Reset to Initial Settings.

**CAUTION**



- Your monitor's OSD (On Screen Display) may differ slightly from that shown in this manual.

Game Mode on SDR(Non-HDR)signal.

Settings > Game Mode		Description
Game Mode	Gamer 1	In this mode, users can customize elements including game-related options.
	Gamer 2	Gamer 1 and Gamer 2 picture modes allow you to save two sets of customized display settings, including game-related setup options.
	FPS	This mode is optimized for FPS games. It is suitable for very dark FPS games.
	RTS	This mode is optimized for RTS Game.
	Vivid	Optimized the screen for vivid colors.
	Reader	Optimizes the screen for viewing documents. You can brighten the screen in the OSD menu.
	HDR Effect	Optimizes the screen for high dynamic range.
	sRGB	A standard RGB color space for the monitor and printer.
	Calibration 1	Adjusts to the last calibrated screen.
	Calibration 2	Adjusts to the previously calibrated screen.
	 NOTE <ul style="list-style-type: none"> • Calibration 2 : Installation of LG Calibration Studio and proceeding Calibration will enable this menu. 	

Game Mode on HDR signal.

Settings > HDR Game Mode		Description
HDR Game Mode	Gamer 1	In this mode, users can customize elements including game-related options.
	Gamer 2	Gamer 1 and Gamer 2 picture modes allow you to save two sets of customized display settings, including game-related setup options.
	FPS	This mode is optimized for FPS games. It is suitable for very dark FPS games.
	RTS	This mode is optimized for RTS Game.
	Vivid	Optimized the screen for vivid colors.
	 NOTE <ul style="list-style-type: none"> • HDR content may not be operated properly depending on the Windows 10 OS setting. Please check the HDR On / Off setting of Windows. • When the HDR function is turned on, the characters or picture quality may be poor according to Graphic card performance. • While the HDR function is on, screen flickering or cracking may occur when changing the monitor input or power on/off according to Graphic card performance. • For information about whether the graphics card and game support HDR, visit their manufacture's website. 	



Settings > Game Adjust		Description	
Game Adjust	Overclock	On	Sets Overclock to a higher refresh rate than specified by the panel specification.
		Off	Disables the Overclock improvement feature.
		 NOTE <ul style="list-style-type: none"> • After the monitor reboots, change the maximum refresh rate setting in the GPU control panel. • If the screen display appears abnormal, turn off the Overclock setting. • The function can only be used through DisplayPort. • The Overclock function's features/performance may vary depending on the graphics card or gaming content. • We do not guarantee the performance of the function and are not responsible for any side effects that may occur from its activation. 	
	Adaptive-Sync/ FreeSync Premium Pro	Provides seamless and natural images by synchronizing the vertical frequency of the input signal with that of the output signal.	
		 CAUTION <ul style="list-style-type: none"> • Supported Interface: DisplayPort (Adaptive-Sync), HDMI (FreeSync Premium Pro). • Supported Graphic Card: A graphic card that supports NVIDIA's G-SYNC or AMD's FreeSync is necessary. • Supported Version: Make sure to update the graphic card to the latest driver. • For more information and requirement, refer to NVIDIA website (www.nvidia.com) and AMD website (www.amd.com). 	
		Extended	Enable wider frequency range of Adaptive-Sync/FreeSync Premium Pro function than basic mode. The screen may flicker during the game play.
		Basic	Enable basic frequency range of Adaptive-Sync/FreeSync Premium Pro function.
		Off	Adaptive-Sync/FreeSync Premium Pro function off.
	Black Stabilizer	You can control the black contrast to have better visibility in dark scenes. You can easily distinguish objects on dark game screens.	



Game Adjust	Response Time	Sets a response time for displayed pictures based on the speed of the screen. For a normal environment, it is recommended that you use Fast . For a fast-moving picture, it is recommended that you use Faster . Once Faster Mode is selected, Motion Blur may occur depending on the content.	
		Faster	Sets the response time to Faster.
		Fast	Sets the response time to Fast.
		Normal	Sets the response time to Normal.
	Off	Does not use the response time improvement feature.	
	Crosshair	Crosshair provides a mark on the center of the screen for First Person Shooter (FPS) games. Users can select the Crosshair that fits their gaming environment among four different Crosshairs.	
	FPS Counter	On	The indicator is displayed on the upper left of the screen. It will reflect the actual frame rate that is received at the input.
		Off	Does not use the FPS Counter feature.
	 NOTE <ul style="list-style-type: none"> • FPS Counter and Crosshair feature can not be used at the same time. 		
	Game Reset	Returns game to the default settings.	
No		Cancel the select.	
	Yes	Returns to the default settings.	

Settings > Picture Adjust		Description	
Picture Adjust	Brightness	Adjusts the brightness of the screen.	
	Contrast	Adjusts the contrast of the screen.	
	Sharpness	Adjusts the sharpness of the screen.	
	Gamma	Mode 1, Mode 2, Mode 3	The higher the gamma value, the darker the image becomes. Likewise, the lower the gamma value, the lighter the image becomes.
		Mode 4	If you do not need to adjust the gamma settings, select Mode 4.
	Color Temp	Custom	The user can adjust it to red, green, or blue by customization.
		Warm	Sets the screen color to a reddish tone.
		Medium	Sets the screen color to between a red and blue tone.
		Cool	Sets the screen color to a bluish tone.
	Manual	The user can fine - tune the color temperature.	
	R/G/B	You can customize the picture color using Red, Green, and Blue colors.	
	Six Color		Meets the user requirements for colors by adjusting the hue and saturation of the six colors (Red, Green, Blue, Cyan, Magenta and Yellow) and then saving the settings.
		Hue	Adjusts the tone of the screen colors.
		Saturation	Adjusts the saturation of the screen colors. The lower the value, the less saturated and brighter the colors become. The higher the value, the more saturated and darker the colors become.
	Black Level		Sets the offset level (for HDMI only). <ul style="list-style-type: none"> • Offset: as a reference for a video signal, this is the darkest color the monitor can display.
		High	Keeps the current contrast ratio of the screen.
Low		Lowers the black levels and raises the white levels from the current contrast ratio of the screen.	

Picture Adjust	Local Dimming	Maximizes the contrast ratio by making the bright areas of the screen brighter and the dark areas of the screen darker. Turning this option off may increase energy consumption.	
		Faster	Sets the local dimming to faster.
		Fast	Sets the local dimming to fast.
		Normal	Sets the local dimming to normal.
	DFC	Off	Does not use the local dimming improvement feature.
		On	Adjusts the brightness automatically according to the screen.
	Picture Reset	Off	Disables the DFC feature.
		Do you want to reset your picture settings?	
		No	Cancel the select.
		Yes	Returns to the default settings.

Settings > Input		Description	
Input	Input List	Selects the input mode.	
	Aspect Ratio	Adjusts the aspect ratio of the screen.	
		Full Wide	Displays the video in widescreen, regardless of the video signal input.
		Original	Displays video according to the aspect ratio of the video signal input.
		Just Scan	The aspect ratio is not adjusted from the original.
	 NOTE <ul style="list-style-type: none"> • The display may look the same for Full Wide and Original options at the recommended resolution. (3840 x 2160) • There is no Just Scan menu on Adaptive-Sync/FreeSync Premium Pro Mode. (Go to Settings → Game Adjust → Adaptive-Sync/FreeSync Premium Pro, to set Adaptive-Sync/FreeSync Premium Pro On or Off) 		

Settings > General		Description	
General	Waves MaxxAudio®	Select the sound equipment what you are using.	
		Over-the-ear	
		On-ear	
		Ear-buds	
		Off	Disables the Waves Maxx Audio feature.
	Language	Sets the menu screen to the desired language.	
	User-defined Key 1	You can customise the main menu to access your preferred menu easily.	
	User-defined Key 2	User-definded Key 1 and User-definded Key 2 appear at the left/right of the main menu.	
	SMART ENERGY SAVING	High	Saves energy using the high-efficiency SMART ENERGY SAVING feature.
		Low	Saves energy using the low-efficiency SMART ENERGY SAVING feature.
		Off	Disables the SMART ENERGY SAVING feature.
	Deep Sleep Mode	When Deep sleep mode is enabled, power consumption is minimized while the monitor is in standby mode.	
		On	Enables Deep sleep Mode .
	Off	Disables Deep sleep Mode .	

General	Lighting Option	Keep Lighting Status	When the monitor turn off, the lighting on the back of the monitor is always on.			
		Turn Off Lighting	When the monitor turn off, the lighting on the back of the monitor turn off. When the monitor turn on, the last selected lighting status turn on.  NOTE <ul style="list-style-type: none"> • When the monitor turn off, you can't turn on the lighting on the back of the monitor. • To turn on the lighting while the monitor is off, change to 'Keep Lighting Status'. 			
	Power LED	Turns the power LED on the bottom of the monitor on or off.				
		On	The power LED turns on automatically.			
		Off	The power LED turns off.			
	Automatic Standby	Feature that automatically turns off the monitor when there is no movement on the screen for a period of time. You can set a timer for the auto-off function. (8H, 6H, 4H and Off)				
	HDMI ULTRA HD Deep Color	Provides sharper images when connected to a device supporting ULTRA HD Deep Color.				
		Resolution	Frame rate(Hz)	Color Depth / Chroma Sampling		
				8 bit	10 bit	
		3840 x 2160	59.94	YCbCr 4:2:0		
60.00			YCbCr 4:2:2			
120.00			YCbCr 4:4:4			
144.00			RGB 4:4:4			
 NOTE <ul style="list-style-type: none"> • To use HDMI ULTRA HD Deep Color, turn this function "On". • If the connected device supports Deep color but the screen or sound does not work properly, set this function to on (120 Hz). • The frame rate supports up to 120 Hz, if HDMI ULTRA HD Deep Color is On (120 Hz). • If the connected device does not support Deep Color, the screen or sound may not work properly. In this case, set this function to off. • The HDMI ULTRA HD Deep Color function can be set individually for each HDMI port. • Check if the graphics card supports 3840 x 2160 / 144 Hz in HDMI. • Check if the graphics card driver has been updated to the latest version. 						

General	DisplayPort Version	Please set the DisplayPort Version to match the version of the connected external device(1.4(DSC), 1.4 and 1.2) . If you want to use the HDR, select the DisplayPort Version to 1.4(DSC) or 1.4.	
	Buzzer	This feature lets you set the sound generated from Buzzer when your monitor powers on.	
		On	Enables your monitor's Buzzer .
		Off	Disables your monitor's Buzzer .
	OSD Lock	This feature disables the configuration and adjustment of menus.	
		On	Enables OSD Lock .
		Off	Disables OSD Lock .
		 NOTE <ul style="list-style-type: none"> All features are disabled except Brightness, Contrast in Picture Adjust, Input, OSD Lock and Information in General. 	
	Information	The display information will be shown the Total Power On Time, Resolution.	
	Reset to Initial Settings	Do you want to reset your settings?	
		No	Cancel the reset.
Yes		Returns to the default settings.	

TROUBLESHOOTING

Nothing is displayed on the screen.	
Is the monitor's power cord plugged in?	<ul style="list-style-type: none"> • Check if the power cord is correctly plugged into the power outlet.
Is the power LED on?	<ul style="list-style-type: none"> • Check the power cable connection and press the power button.
Is the power on and the power LED displaying white?	<ul style="list-style-type: none"> • Check that the connected input is enabled (Settings > Input).
Is the power LED blinking?	<ul style="list-style-type: none"> • If the monitor is in sleep mode, move the mouse, or press any key on the keyboard, to switch the display on. • Check if the computer is turned on.
Is the " The screen is not currently set to the recommended resolution. If you have no video or the screen flickers, see the troubleshooting guide in the product owner's manual. " message being displayed?	<ul style="list-style-type: none"> • This occurs when signals transferred from the PC (graphics card) are out of the recommended horizontal or vertical frequency range of the monitor. Please see the Product Specification section of this manual to set the appropriate frequency.
Is the " No Signal " message being displayed?	<ul style="list-style-type: none"> • This is displayed when the signal cable between the PC and the monitor is missing or disconnected. Check the cable and reconnect it.
Have you installed the display driver?	<ul style="list-style-type: none"> • Be sure to install the display driver from our web site: http://www.lg.com. • Make sure to check if the graphics card supports Plug and Play function.

Some features are disabled.	
Are some functions not available when you press the Menu button?	<ul style="list-style-type: none"> • The OSD is locked. Go to Settings > General and set OSD Lock to Off.

The screen retains an image.

Does image sticking occur even when the monitor is turned off?

- Displaying a still image for a prolonged time may cause damage to the screen, resulting in the retention of the image.
- To extend the lifetime of the monitor, use a screensaver.

Screen display is unstable and shaky. / Images displayed on the monitor leave shadow trails.

Did you select the appropriate resolution?

- If the selected resolution is HDMI 1080i 60/50 Hz (interlaced), the screen may be flickering. Change the resolution to 1080p or the recommended resolution.

3840 x 2160 resolution is not available in DisplayPort. (144 Hz or Higher)

Is it connected to the correct input?

- If it is connected with HDMI input, set it to DisplayPort input.
Go to **Settings > General > DisplayPort Version** and set the option to **1.4(DSC)**.
Go to **Settings > Game Adjust > Overclock** and set the option to **On**. (For 160 Hz)
- Check if the graphics card supports the **DSC** (Display Stream Compression).
- Check if the graphics card driver has been updated to the latest version.

3840 x 2160 resolution is not available in HDMI. (144 Hz)

Is it connected to the correct graphics card?

- Check if the graphics card supports 3840 x 2160 / 144 Hz in HDMI. (NVIDIA RTX3000 Series, AMD RX6000 Series or higher)
- Check if the graphics card driver has been updated to the latest version.

**NOTE**

- **Vertical Frequency:** In order to display an image, the screen must be refreshed dozens of times per second, like a fluorescent lamp. The number of times the screen is refreshed per second is called vertical frequency, or refresh rate, and is represented by Hz.
- **Horizontal Frequency:** The time it takes to display one horizontal line is called the horizontal cycle. If 1 is divided by the horizontal interval, the result is the number of horizontal lines displayed per second. This is called horizontal frequency and is represented by kHz.
- Check if the graphics card's resolution or frequency is within the range allowed by the monitor and set it to the recommended (optimal) resolution **Control Panel > Display > Settings** in Windows. (The settings may differ depending on the operating system (OS) you use.)
- Not setting the graphics card to the recommended (optimal) resolution may result in blurred text, a dimmed screen, a truncated display area or misalignment of the display.
- The setting methods may be different depending on the computer or operating system, and some resolutions may not be available depending on the performance of the graphics card. If this is the case, contact the manufacturer of the computer or graphics card for assistance.
- Some graphics cards may not support 3840 x 2160 resolution. If the resolution cannot be displayed, contact the manufacturer of your graphics card.

The display color is abnormal.	
Does the display appear discolored (16 colors)?	<ul style="list-style-type: none"> • Set the color to 24 bit (true color) or higher. In Windows, go to Control Panel > Display > Settings > Color Quality. (The settings may differ depending on the operating system (OS) you use.)
Does the display color appear unstable or monochrome?	<ul style="list-style-type: none"> • Check if the signal cable is connected properly. Reconnect the cable or reinsert the PC's graphics card.
Are there spots on the screen?	<ul style="list-style-type: none"> • When using the monitor, pixilated spots (red, green, blue, white, or black) may appear on the screen. This is normal for an LCD screen. It is not an error, nor is it related to the monitor's performance.

No sound from the headphone port.	
Are images displayed using DP (DisplayPort) or HDMI input without sound?	<ul style="list-style-type: none"> • Make sure that the headphone port connections are made properly. • Try increasing the volume with the joystick. • Set the audio output of the PC to the monitor you are using. On Microsoft Windows, go to Control Panel > Hardware and Sound > Sound > set the Monitor as default device. (The settings may differ depending on the operating system (OS) you use.)

PRODUCT SPECIFICATION

LCD Screen	Color Depth	HDMI	8-bit/10-bit color is supported.
		DP (DisplayPort)	10-bit color is supported.
Resolution	Max Resolution	3840 x 2160 @ 144 Hz (HDMI) 3840 x 2160 @ 160 Hz (DP/Over Clock on)	
	Recommended Resolution	3840 x 2160 @ 144 Hz (HDMI) 3840 x 2160 @ 144 Hz (DP)	
Power Sources	Power Rating	19 V --- 5.0 A	
	Power Consumption (Typical)	On mode: 65 W (Typical)* Sleep Mode (Standby Mode) : ≤ 0.5 W ([Deep Sleep Mode]: [On])** Off Mode: ≤ 0.3 W	
AC/DC Adapter	ADS-110CL-19-3 190110G, manufactured by SHENZHEN HONOR ELECTRONIC ADS-120QL-19A-3 190110E, manufactured by SHENZHEN HONOR ELECTRONIC Output: 19 V --- 5.79 A		
Environmental Conditions	Operating Conditions	Temperature	0 °C to 40 °C (32 °F to 104 °F)
		Humidity	Less than 80 %
	Storing Conditions	Temperature	-20 °C to 60 °C (-4 °F to 140 °F)
		Humidity	Less than 85 %

Dimensions	Monitor Size (Width x Height x Depth)	
	With Stand	609.2 x 574.7 x 291.2 (mm) 23.9 x 22.6 x 11.4 (inches)
	Without Stand	609.2 x 352.9 x 54.3 (mm) 23.9 x 13.8 x 2.1 (inches)
Weight (Without Packaging)	With Stand	7.9 kg (17.4 lbs)
	Without Stand	5.7 kg (12.5 lbs)

Specifications are subject to change without notice.

The ~ symbol means alternating current, and the symbol --- means direct current.

The Power Consumption level can be different by operating condition and monitor setting.

* The On mode power consumption is measured with LGE test standard (Full White pattern , Maximum resolution).

** The monitor goes to the Sleep Mode in a couple of minutes (Max 5 minutes).

Factory Support Mode

(Preset Mode, HDMI/ DisplayPort PC)

Preset Mode	Horizontal Frequency (kHz)	Vertical Frequency (Hz)	Polarity (H/V)	Remarks
640 x 480	31.469	59.94	-/-	DisplayPort / HDMI
800 x 600	37.879	60.317	+/+	DisplayPort / HDMI
1024 x 768	48.363	60	-/-	DisplayPort / HDMI
1920 x 1080	67.50	60	+/+	DisplayPort / HDMI
1920 x 1080	166.587	143.98	-/+	DisplayPort / HDMI
2560 x 1440	182.996	120	+/-	HDMI
2560 x 1440	222.151	143.97	-/+	DisplayPort / HDMI
3840 x 2160	67.5	30	+/-	HDMI
3840 x 2160	133.31	60	+/-	DisplayPort
3840 x 2160	135	60	+/-	HDMI
3840 x 2160	214.563	94.98	+/-	DisplayPort 1.4 (DSC*) / DisplayPort 1.4
3840 x 2160	268.44	120	+/-	DisplayPort 1.4
3840 x 2160	332.06	144	+/-	DisplayPort 1.4 (DSC*)/HDMI (Recommended)
3480 x 2160	373.06	159.98	+/-	DisplayPort 1.4 (DSC*), OverClock On

* DSC: Display Stream Compression.

* To display 144 Hz or over, make sure to use the graphics card that supports DSC (Display Stream Compression).

HDMI Timing (Video)

Preset Mode	Horizontal Frequency (kHz)	Vertical Frequency (Hz)	Remarks
480P	31.5	60	
576P	31.25	50	
720P	37.5	50	
720P	45	60	
1080P	56.25	50	
1080P	67.5	60	
1080P	135	120	
2160P	54	24	
2160P	56.25	25	
2160P	67.5	30	
2160P	112.5	50	
2160P	135	60	
2160P	270	120	

Power LED

Mode	LED Color
On Mode	Red (For a few seconds)
Sleep Mode (Standby Mode)	Off
Off Mode	Off

Beep Guide

Menu	Location
Game Mode	1
Game Mode - Gamer1	1 1
Game Mode - Gamer2	1 2
Game Mode - FPS	1 3
Game Mode - RTS	1 4
Game Mode - Vivid	1 5
Game Mode - Reader	1 6
Game Mode - HDR Effect	1 7
Game Mode - sRGB	1 8
Game Mode - Calibration 1	1 9
Game Mode - Calibration 2	1 10
Game Adjust	2
Game Adjust - Overclock	2 1
Game Adjust - Overclock - On	2 1 1
Game Adjust - Overclock - Off	2 1 2
Game Adjust - FreeSync Premium Pro / Adaptive-Sync	2 2
Game Adjust - FreeSync Premium Pro / Adaptive-Sync - Extended	2 2 1
Game Adjust - FreeSync Premium Pro / Adaptive-Sync - Basic	2 2 2
Game Adjust - FreeSync Premium Pro / Adaptive-Sync - Off	2 2 3
Game Adjust - Black Stabilizer	2 3

Menu	Location
Game Adjust - Black Stabilizer	2 3 1 Slider
Game Adjust - Response Time	2 4
Game Adjust - Response Time - Faster	2 4 1
Game Adjust - Response Time - Fast	2 4 2
Game Adjust - Response Time - Normal	2 4 3
Game Adjust - Response Time - Off	2 4 4
Game Adjust - Crosshair	2 5
Game Adjust - Crosshair - Red Cross	2 5 1
Game Adjust - Crosshair - Green Cross	2 5 2
Game Adjust - Crosshair - Red Dot	2 5 3
Game Adjust - Crosshair - Green Dot	2 5 4
Game Adjust - Crosshair - Off	2 5 5
Game Adjust - FPS Counter	2 6
Game Adjust - FPS Counter - On	2 6 1
Game Adjust - FPS Counter - Off	2 6 2
Game Adjust - Game Reset	2 7
Game Adjust - Game Reset - No	2 7 1
Game Adjust - Game Reset - Yes	2 7 2
Picture Adjust	3
Picture Adjust - Brightness	3 1
Picture Adjust - Brightness	3 1 1 Slider

Menu	Location
Picture Adjust - Contrast	3 2
Picture Adjust - Contrast	3 2 1 Slider
Picture Adjust - Sharpness	3 3
Picture Adjust - Sharpness	3 3 1 Slider
Picture Adjust - Gamma	3 4
Picture Adjust - Gamma - Mode 1	3 4 1
Picture Adjust - Gamma - Mode 2	3 4 2
Picture Adjust - Gamma - Mode 3	3 4 3
Picture Adjust - Gamma - Mode 4	3 4 4
Picture Adjust - Color Temp	3 5
Picture Adjust - Color Temp - Custom	3 5 1
Picture Adjust - Color Temp - Warm	3 5 2
Picture Adjust - Color Temp - Medium	3 5 3
Picture Adjust - Color Temp - Cool	3 5 4
Picture Adjust - Color Temp - Manual	3 5 5
Picture Adjust - Color Temp - Manual	3 5 5 1 Slider
Picture Adjust - R/G/B	3 6
Picture Adjust - R/G/B - Red	3 6 1 Slider
Picture Adjust - R/G/B - Green	3 6 2 Slider

Menu	Location
Picture Adjust - R/G/B - Blue	3 6 3 Slider
Picture Adjust - Six Color	3 7
Picture Adjust - Six Color - Red Hue	3 7 1 Slider
Picture Adjust - Six Color - Red Saturation	3 7 2 Slider
Picture Adjust - Six Color - Green Hue	3 7 3 Slider
Picture Adjust - Six Color - Green Saturation	3 7 4 Slider
Picture Adjust - Six Color - Blue Hue	3 7 5 Slider
Picture Adjust - Six Color - Blue Saturation	3 7 6 Slider
Picture Adjust - Six Color - Cyan Hue	3 7 7 Slider
Picture Adjust - Six Color - Cyan Saturation	3 7 8 Slider
Picture Adjust - Six Color - Magenta Hue	3 7 9 Slider
Picture Adjust - Six Color - Magenta Saturation	3 7 10 Slider
Picture Adjust - Six Color - Yellow Hue	3 7 11 Slider
Picture Adjust - Six Color - Yellow Saturation	3 7 12 Slider
Picture Adjust - Black Level	3 8
Picture Adjust - Black Level - High	3 8 1

Menu	Location
Picture Adjust - Black Level - Low	3 8 2
Picture Adjust - Local Dimming	3 9
Picture Adjust - Local Dimming - Faster	3 9 1
Picture Adjust - Local Dimming - Fast	3 9 2
Picture Adjust - Local Dimming - Normal	3 9 3
Picture Adjust - Local Dimming - Off	3 9 4
Picture Adjust - DFC	3 10
Picture Adjust - DFC - On	3 10 1
Picture Adjust - DFC - Off	3 10 2
Picture Adjust - Picture Reset	3 11
Picture Adjust - Picture Reset - No	3 11 1
Picture Adjust - Picture Reset - Yes	3 11 2
Input	4
Input - Input List	4 1
Input - Input List - HDMI 1	4 1 1
Input - Input List - HDMI 2	4 1 2
Input - Input List - DisplayPort	4 1 3
Input - Aspect Ratio	4 2
Input - Aspect Ratio - Full Wide	4 2 1
Input - Aspect Ratio - Original	4 2 2
Input - Aspect Ratio - Just Scan	4 2 3
General	5
Waves MaxxAudio®	5 1
Waves MaxxAudio®-Over-the-ear	5 1 1

Menu	Location
Waves MaxxAudio®-On-ear	5 1 2
Waves MaxxAudio®-Ear-buds	5 1 3
Waves MaxxAudio®-Off	5 1 4
General - Language	5 2
General - Language - English	5 2 1
General - Language - German	5 2 2
General - Language - French	5 2 3
General - Language - Spanish	5 2 4
General - Language - Italian	5 2 5
General - Language - Swedish	5 2 6
General - Language - Finnish	5 2 7
General - Language - Portuguese	5 2 8
General - Language - Portuguese (Brazil)	5 2 9
General - Language - Polish	5 2 10
General - Language - Russian	5 2 11
General - Language - Greek	5 2 12
General - Language - Ukrainian	5 2 13
General - Language - Chinese	5 2 14
General - Language - Traditional Chinese	5 2 15
General - Language - Japanese	5 2 16
General - Language - Korean	5 2 17
General - User-defined Key 1	5 3
General - User-defined Key 1 - Input	5 3 1

Menu	Location
General - User-defined Key 1 - Game Mode	5 3 2
General - User-defined Key 1 - Crosshair	5 3 3
General - User-defined Key 1 - Black Stabilizer	5 3 4
General - User-defined Key 1 - Response Time	5 3 5
General - User-defined Key 1 - FPS Counter	5 3 6
General - User-defined Key 2	5 3
General - User-defined Key 2 - Input	5 3 1
General - User-defined Key 2 - Game Mode	5 3 2
General - User-defined Key 2 - Crosshair	5 3 3
General - User-defined Key 2 - Black Stabilizer	5 3 4
General - User-defined Key 2 - Response Time	5 3 5
General - User-defined Key 2 - FPS Counter	5 3 6
General - SMART ENERGY SAVING	5 5
General - SMART ENERGY SAVING - High	5 5 1
General - SMART ENERGY SAVING - Low	5 5 2
General - SMART ENERGY SAVING - Off	5 5 3
General - Deep Sleep Mode	5 6
General - Deep Sleep Mode - On	5 6 1
General - Deep Sleep Mode - Off	5 6 2

Menu	Location
General - Lighting Option	5 7
General - Lighting Option - Keep Lighting Status	5 7 1
General - Lighting Option - Turn Off Lighting	5 7 2
General - Power LED	5 8
General - Power LED - On	5 8 1
General - Power LED - Off	5 8 2
General - Automatic Standby	5 9
General - Automatic Standby - 8H	5 9 1
General - Automatic Standby - 6H	5 9 2
General - Automatic Standby - 4H	5 9 3
General - Automatic Standby - Off	5 9 4
General - HDMI ULTRA HD Deep Color	5 10
General - HDMI ULTRA HD Deep Color - On(144Hz)	5 10 1
General - HDMI ULTRA HD Deep Color - On(120Hz)	5 10 2
General - HDMI ULTRA HD Deep Color - Off	5 10 3
General - DisplayPort Version	5 11
General - DisplayPort Version - 1.4(DSC)	5 11 1
General - DisplayPort Version - 1.4	5 11 2
General - DisplayPort Version - 1.2	5 11 3
General - Buzzer	5 12
General - Buzzer - On	5 12 1

Menu	Location
General - Buzzer - Off	5 12 2
General - OSD Lock	5 13
General - OSD Lock - On	5 13 1
General - OSD Lock - Off	5 13 2
General - Information	5 14
General - Reset to Initial Settings	5 15
General - Reset to Initial Settings - No	5 15 1
General - Reset to Initial Settings - Yes	5 15 2



Supplier's Declaration of Conformity

Trade Name	LG
Responsible Party	LG Electronics USA, Inc.
Address	111 Sylvan Avenue, North Building, Englewood Cliffs, NJ 07632
E-mail	lg.environmental@lge.com

The model and serial number of the product are located on the back and on one side of the product.

Record them below in case you ever need service.

Model _____

Serial No. _____