

## TROUBLESHOOTING

### No image

1. Ensure the power plug and, in case of external sources, the video-cable plugs are installed correctly at both ends.
2. Check if the main power switch is set to "I"
3. Check if the e-Screen is not in standby mode by pressing the on/off button on the remote or e-Screen control pad.
4. Make sure the correct input is selected.
5. Check that source equipment is operating correctly, for instance:
  - The source is turned on and not in standby or sleep mode
  - All video cables are not damaged (e.g. cable breaks or bend pins inside the connector)
  - If possible check with other source and cables
6. In case of long video cables (>5m): check signal transmission with the originally supplied cables.
7. In case of installations with peripheral equipment such as distribution amplifiers, matrix switchers, signal boosters, etc.: check the working of the screen with the source directly connected to the e-Screen, using the originally supplied cables.

### Bad image quality of source signal

1. Check that source equipment is operating correctly, for instance:
  - All video cables are installed correctly at both ends and not damaged (e.g. cable breaks or bend pins inside the connector).
  - Make sure the resolution of the input signal is set to the native resolution of the e-Screen 3840x2160@30Hz or 60Hz).
2. If possible check with other source and cables.

### The image is positioned correctly

1. Disconnect and reconnect the signal cable
2. Restart the entire system, make sure to first switch on the monitor and secondly the source or OPS PC
3. Perform a factory reset from the menu of the e-Screen

Information in this document is subject to change without notice. 2017 Legamaster International B.V. All rights reserved. Reproduction in any manner whatsoever without the written permission of Legamaster International is strictly forbidden. Trademarks used in this text: Legamaster and the Legamaster logo are trademarks of edding AG; Windows is a registered trademark of Microsoft Corporation, OS X is a trademark of Apple Inc., Linux is a trademark of Linus Torvalds. Other trademarks and trade names may be used in this document to refer to either the entities claiming the marks and names or their products. Legamaster International disclaims any proprietary interest in trademarks and trade names other than its own.

### The image is too light or too dark

1. Adjust the brightness and contrast of the e-Screen
2. Make sure no direct light source shines on the brightness sensor on the backside of the e-Screen

### The picture color looks poor

1. Check the colour picture settings of the e-Screen
2. Perform a factory reset from the menu of the e-Screen

### No Touch

1. Make sure the USB cable is installed correctly at both ends and not damaged
2. Disconnect and reconnect the USB cable after 10 seconds, please allow the PC to detect the hardware. This can take a few seconds
3. Reboot the PC.

### Touch performance is poor or is not at the same position

1. Make sure there are no unwanted objects in range of the touch system (e.g. jacket sleeves).
2. Make sure there are no light sources (e.g. halogen lamps or sun light) shining directly at the surface of the e-Screen.
3. Place your finger or stylus in a 90 degree angle on the touch surface.
4. Do not hold the stylus too close towards the tip.
5. Please make sure the inside of the bezel (where the touch sensors are placed) is clean(ed) and free of items blocking the view of the sensors (e.g. a magnet).
6. Turn off scaling in the display settings of the source.

### Touch recognition is slow

1. Close all active windows on the PC
2. Reboot the PC

Legamaster International B.V.  
Postbus 111  
7240 AC Lochem  
tel.: (+31) (0)573-713000  
email: info@legamaster.com  
internet: www.legamaster.com

Legamaster, brand of the edding group

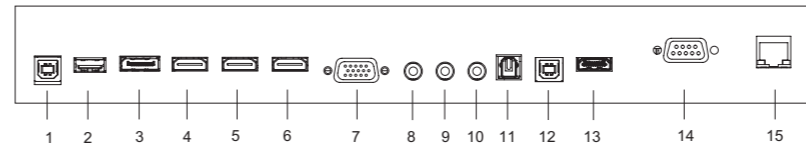
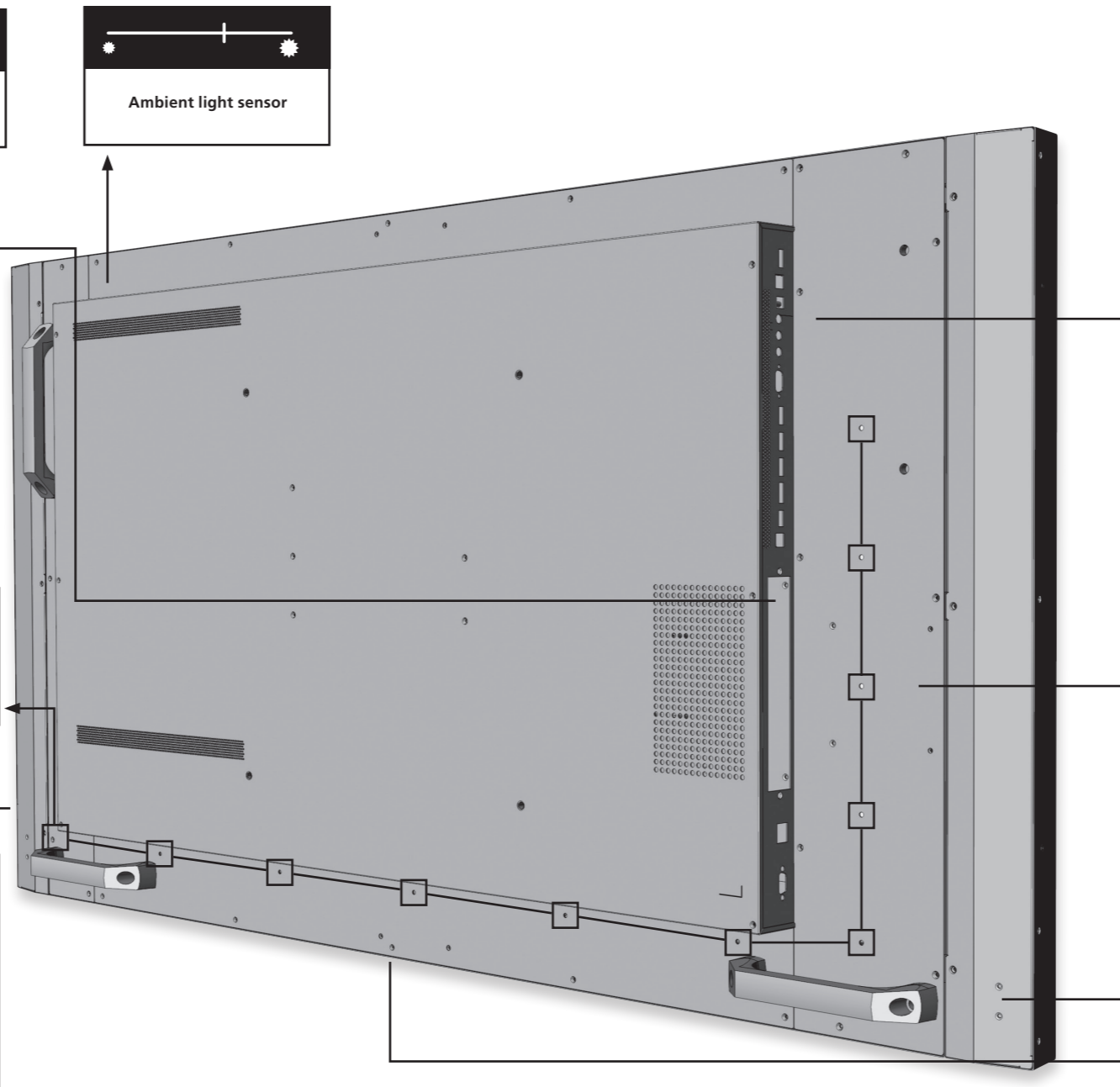
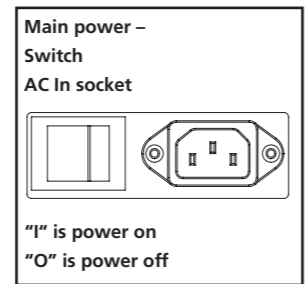
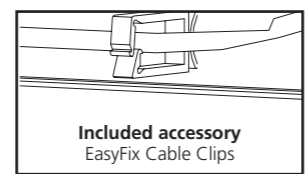
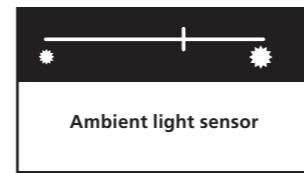
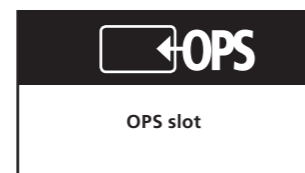

### CONNECTOR TABLE

1	Touch USB 1
2	Service USB port
3	DisplayPort
4-5	HDMI 1, 2
6	HDMI out
7	VGA In (15-pin D-Sub)
8	PC Audio In
9	IR Extender
10	Audio Out
11	SPDIF
12	Touch USB 2
13	HDMI 3
14	RS-232C
15	Ethernet

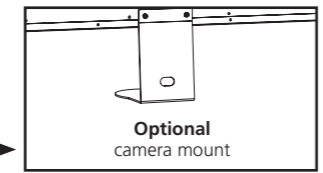
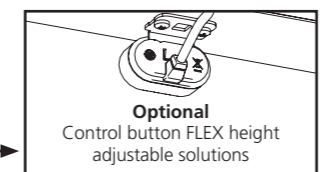
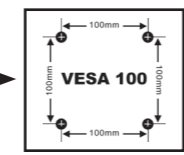

# XTX-5500UHD QUICK SETUP GUIDE

Version 1.0

**INTRODUCTION**

Thank you for purchasing this Legamaster e-Screen interactive display. This Quick Setup Guide will help you setup the monitor and cover the basic operation instructions.

Please refer to the user manual that can be found on the USB drive for more detailed instructions and the full safety and installation information.

**CAUTION**  
MOUNTING OF THIS PRODUCT CAN ONLY BE EXECUTED BY QUALIFIED STAFF

**CAUTION**  
TO REDUCE THE RISK OF ELECTRIC SHOCK, MAKE SURE POWER CORD IS UNPLUGGED FROM WALL SOCKET. TO FULLY DISENGAGE THE POWER TO THE UNIT, PLEASE DISCONNECT THE POWER CORD FROM THE AC OUTLET. DO NOT REMOVE COVER (OR BACK). NO USER SERVICEABLE PARTS INSIDE. REFER SERVICING TO QUALIFIED SERVICE

**WARRANTY**

Legamaster guarantees the repair or replacement, free of charge, of faulty e-Screen XTX products and/or parts by an authorized service partner for a warranty period of 5 years. The warranty shall take effect on the date of purchase as stated on the receipt.

If you wish to make a claim under the warranty or you have any other service issues, please contact your dealer or Legamaster directly. Please refer to [www.Legamaster.com/warranty](http://www.Legamaster.com/warranty) for specific warranty information for your market.

**RECYCLING INFORMATION**

This product, when disposed of, is supposed to be collected and recycled according to your country's legislation to reduce environmental burden. When you dispose of this product, please contact a distributor or an affiliate in your country. The contact addresses are listed on the Legamaster website <http://www.legamaster.com>.

By disposing this product correctly you will help ensure that the waste undergoes the necessary treatment, recovery and recycling and thus prevent potential negative effects on the environment and human health which could otherwise arise due to inappropriate waste handling.

**COMPLIANCE**

**FCC:**  
FCC CFR Title 47 Part 15 Subpart B Class A, CISPR 22  
ANSI C63.4  
ICES-003 Issue 5

EN 61000-3-2  
EN 61000-3-3

**cTUVus:**  
UL 60950-1  
CAN/CSA-C22.2 No. 60950-1-07

**CE:**  
EN 55022  
EN 55024

**CB:**  
IEC 60950-1

**INCLUDED ACCESSORY**

Item
IR Remote Control (Batteries Included)
IR Extender
HDMI Cable
USB Type B to A
Power Cord
USB drive with user manual
Bag with EasyFix cable clips
Legamaster high precision stylus

FULL HD 1080  
Integrated wide angle cameras in Full HD (connected to OPS slot)

Build in microphone array (connected to OPS slot)

IR receiver + status LED

LED Illumination	Condition
Green	Normal operation
Blinking Orange	No signal
Orange	Power Saving
Off	Power off AC off

**CONTROL PAD TABLE**

Key	Description
	Power (up) Power Switch; Power ON/OFF
	Source (Down) Source Selection
	Volume+ (Right) Volume +
	Volume- (Left) Volume -

USB 3.0 (connected to OPS slot)

**OPERATIONS**

**TURNING THE DISPLAY ON AND OFF**

**Turning the display on**

1. Connect the display to an AC power outlet
2. Ensure the AC switch is set to "—"
3. Press the power button on the control pad, alternatively you can use the power button on the remote control.

**Turning the display off**

With the Power on, press the power button on the control pad. A warning message will appear. Press the power button again to confirm shut down. Alternatively you can use the power button on the remote control. To turn off power completely, turn the AC switch to „O“ or disconnect the AC power cord from the power outlet.

**Note:** If there is no signal input for a period of time, the display will automatically go into power saving (sleep) mode.

**ADJUSTING THE VOLUME AND INPUT SOURCE**

**Adjusting the Volume**

1. Using the remote or control panel, press the VOLUME- or VOLUME+ to increase or decrease the volume.

The display will automatically switch to the selected input after two seconds:  
VGA / DisplayPort / HDMI 1 / HDMI 2 / HDMI 3 / OPS

**Selecting the input source**

1. Press the **SOURCE** select button (▼▲) on the control pad of the display and toggle to the desired input source.

2. Using the remote, press the desired source button (DISPLAYPORT, HDMI1, HDMI2, HDMI3, HDMI4, VGA)
3. If the display cannot find a source, a "No signal" message will appear.

**REMOTE CONTROL**

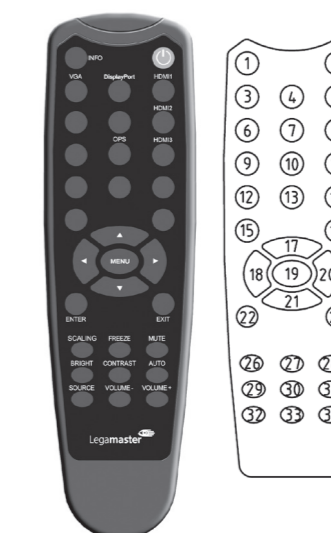

Label	Description
1	INFO Provides source and resolution information
2	Power Turns the display on and off
3	VGA Selects the PC RGB source
4	DISPLAYPORT Selects the DisplayPort source
5, 8, 11	HDMI 1, 2, 3 Selects the HDMI source
10	OPS Selects the OPS computer source
19	MENU Opens the display's on-screen menu system.
17, 18, 20, 21	Navigation arrows When the menu system is already open, pressing this button will select the previous submenu/Navigates through submenus and settings
22	ENTER Selects highlighted menu choices
23	EXIT Closes the menu system
26	SCALING Selects each aspect ratio, in sequence: Full Screen, Native, Letter Box and Pillar Box
27	FREEZE Freezes the current picture on the screen
28	MUTE Turns off the sound
29	BRIGHTNESS Adjusts the brightness
30	CONTRAST Adjusts the contrast
31	AUTO Auto adjustment of VGA source
32	SOURCE Selects each source, in sequence
33/34	VOLUME +/- Decreases/ Increases the sound volume