



OWNER'S MANUAL

IPS LED Monitor

(LED Monitor*)

* LG LED Monitor applies LCD screen with LED backlights.

Please read this manual carefully before operating your set and retain it for future reference.

38UC99

TABLE OF CONTENTS

LICENSE.....3

ASSEMBLING AND PREPARING 4

- Product Composition.....4
- Supported Drivers and Software5
- Product and Button Description.....6
 - How to Use the Joystick Button
 - Input Connector
- Moving and Lifting the Monitor.....8
- Installing the Monitor10
 - Assembling the Stand
 - Installing on a Table
 - Adjusting the Stand Height
 - Adjusting the Angle
 - Tidying up Cables
 - Using the Kensington Lock
 - Detaching the Stand Body
 - Installing the Wall Mount Plate
 - Installing on the Wall

USING THE MONITOR..... 20

- Connecting to a PC.....20
 - HDMI Connection
 - DisplayPort Connection
 - USB-C connection
- Connecting AV Devices.....23
 - HDMI Connection
- Connecting Peripherals.....23
 - USB Cable connection
 - Connecting Headphones
- Service only port25

USER SETTINGS 26

- Activating the Main Menu26
 - Main Menu Features
- User Settings28
 - Menu Settings
 - Quick Settings
 - Input
 - Picture
 - Sound
 - General

TROUBLESHOOTING 47

PRODUCT SPECIFICATION 50

- Factory Support Mode.....52
- HDMI Timing (Video).....53
- Power LED53
- Wireless module (WB1NP6) Specifications.....53

WARNING: This product contains chemicals known to the State of California to cause cancer and birth defects or other reproductive harm. ***Wash hands after handling.***

LICENSE

Each model has different licenses. Visit www.lg.com for more information on the license.



The terms HDMI and HDMI High-Definition Multimedia Interface, and the HDMI logo are trademarks or registered trademarks of HDMI Licensing LLC in the United States and other countries.



VESA, VESA logo, DisplayPort compliance logo and DisplayPort compliance logo for dual-mode source devices are all registered trademarks of the Video Electronics Standards Association.



The SuperSpeed USB Trident logo is a registered trademark of USB Implementers Forum, Inc.



The *Bluetooth*® word mark and logos are registered trademarks owned by Bluetooth SIG, Inc. and any use of such marks by LG Electronics Inc. is under license. Other trademarks and trade names are those of their respective owners.

ASSEMBLING AND PREPARING

Product Composition

Please check whether all the components are included in the box before using the product. If there are any missing components, contact the retailer where you purchased the product. Note that the product and related components may look different from those shown here.

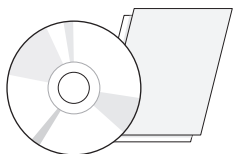

CD (Owner's Manual / Software /
Guides) / Cards

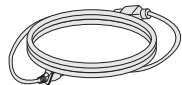

Power Cord

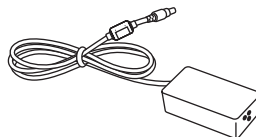

AC/DC Adapter

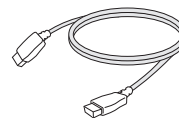

HDMI Cable



DisplayPort Cable

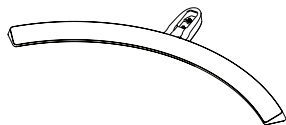

Stand Base



Cable Holder

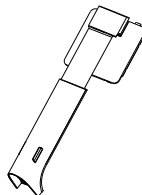

Stand Body

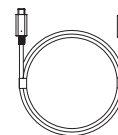

USB C-C Cable



USB C-A Gender



CAUTION

- Always use genuine LG components to ensure safety and product performance.
- The product warranty will not cover damage or injury caused by the use of unauthorized components.
- It is recommend that use the supplied components.
- If you use generic cables not certified by LG, the screen may not display or there may be image noises.



NOTE

- The components may look different from those illustrated here.
- Without prior notice, all product information and specifications contained in this manual are subject to change to improve the performance of the product.
- To purchase optional accessories, visit an electronics store or an online shopping site, or contact the retailer from which you purchased the product.
- The power cord provided may differ depending upon the region.

Supported Drivers and Software

Check the drivers and software supported by your product and refer to the manuals on the CD enclosed in the product package.

Drivers and Software	Installation Priority	38UC99
Monitor Driver	Recommended	O
ASM Driver	Required	X
OnScreen Control	Recommended	O
Dual Controller	Optional	X
True Color Pro	Optional	X

- Required and Recommended: You can download and install the latest version from the enclosed CD or from the LGE website (www.lg.com).
- Optional: You can download and install the latest version from the LGE website (www.lg.com).

Product and Button Description

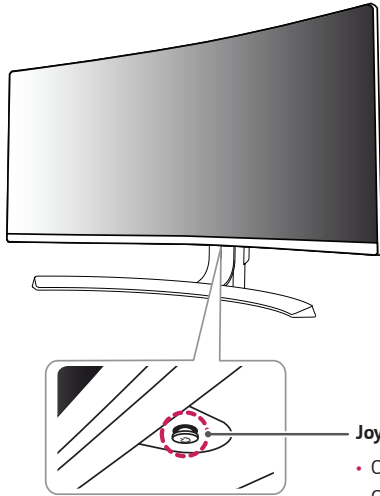

Joystick Button / Power LED

- On: Power on
- Off: Power off

How to Use the Joystick Button

You can easily control the functions of the monitor by pressing the joystick button or moving it left/right with your finger.

Basic Functions

		Power on	Press the joystick button once with your finger to turn on the monitor.
		Power off	Press and hold the joystick button once with your finger to turn off the monitor.
		Volume Control	You can control the volume by moving the joystick button left/right.

! NOTE

- The joystick button is located at the bottom of the monitor.

Input Connector

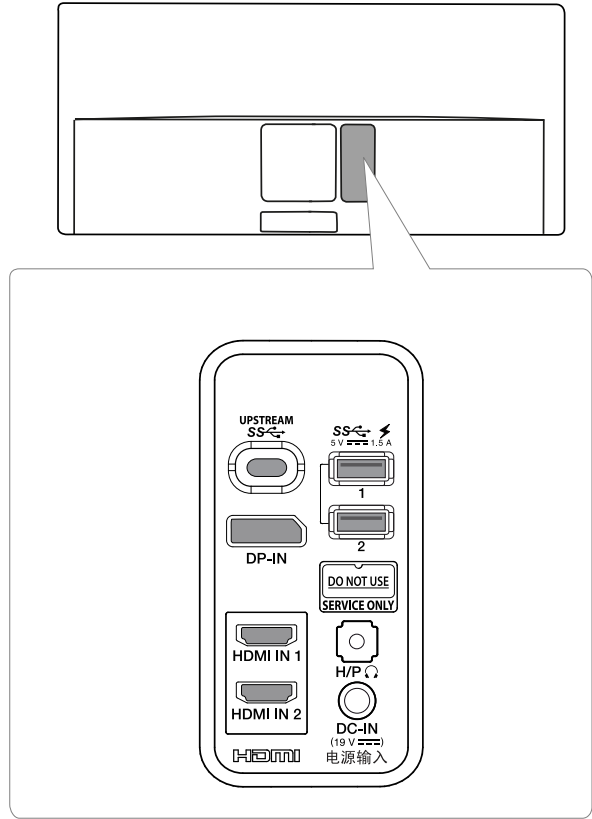

Moving and Lifting the Monitor

When moving or lifting the monitor, follow these instructions to prevent the monitor from being scratched or damaged and to ensure safe transportation, regardless of its shape or size.

- Place the monitor in the original box or packing material before attempting to move it.
- Before moving or lifting the monitor, disconnect the power cord and all other cables.
- Hold the bottom and side of the monitor frame firmly. Do not hold the panel itself.

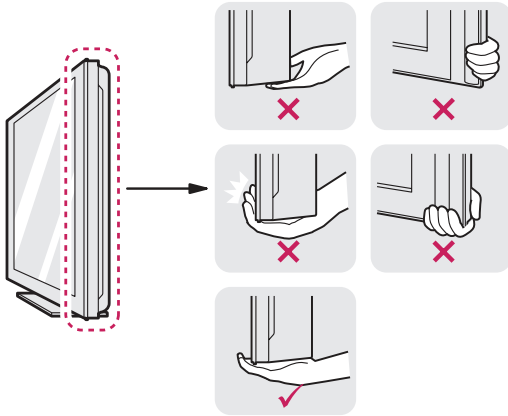

- When holding the monitor, the screen should face away from you to prevent it from being scratched.
- When transporting the monitor, do not expose the monitor to shock or excessive vibration.
- When moving the monitor, keep it upright and never turn the monitor on its side or tilt it sideways.

CAUTION

- Avoid touching the monitor screen as much as possible.
 - This may result in damage to the screen or some of the pixels used to create images.



- If you use the monitor panel without the stand base, its joystick button may cause the monitor to become unstable and fall, resulting in damage to the monitor or human injury. In addition, this may cause the joystick button to malfunction.

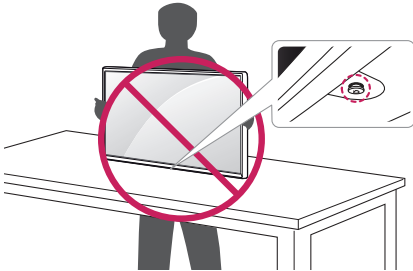

Installing the Monitor

Assembling the Stand

1

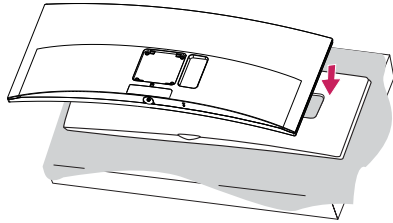

2

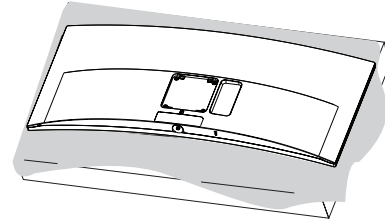

CAUTION

- To protect the screen, place the screen face down on the screen pad which is inside the box.

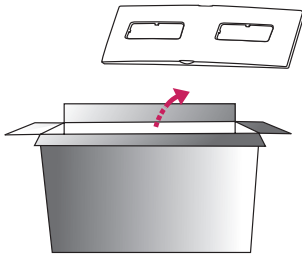

3

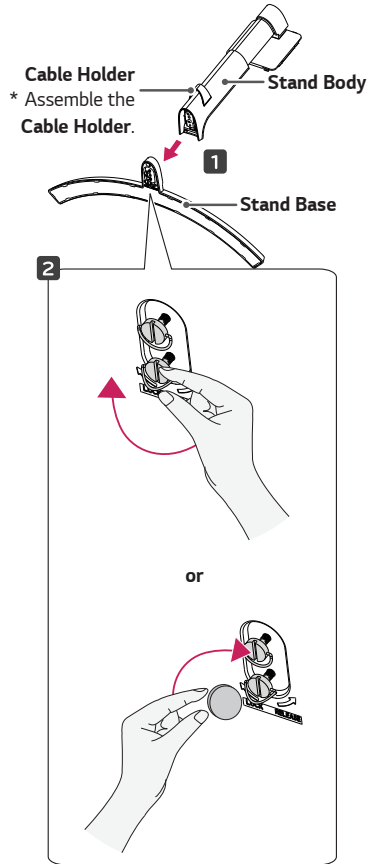

4

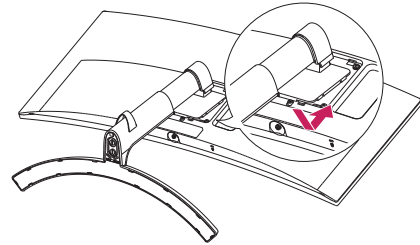

5

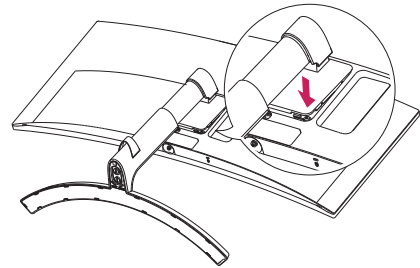

NOTE

- Press the stand until the button reaches the top.

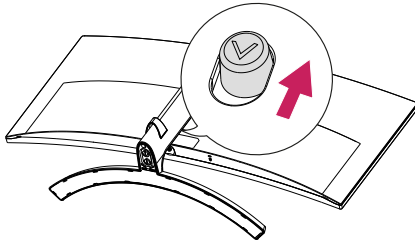
**CAUTION**

- Illustrations in this document represent typical procedures, so they may look different from the actual product.
- Applying excessive force when tightening screws may cause damage to the monitor. Damage caused in this way will not be covered by the product warranty.
- Do not carry the monitor upside down by just holding the base. This may cause the monitor to fall off the stand and could result in personal injury.
- When lifting or moving the monitor, do not touch the monitor screen. The force applied to the monitor screen may cause damage to it.

Installing on a Table

- 1 Lift the monitor and place it on the table in an upright position. Place the monitor at least 100 mm (3.9 inches) away from the wall to ensure sufficient ventilation.

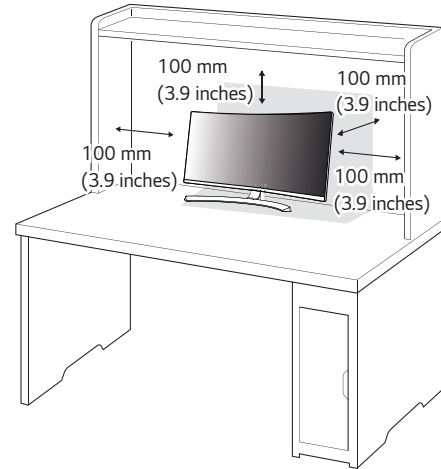

- 2 Connect the power adapter to the monitor and then plug the power cord into the wall outlet.

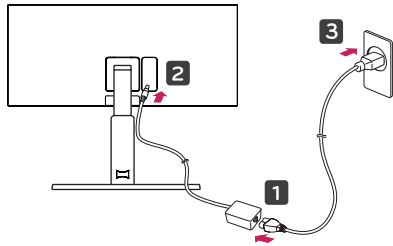

- 3 Press the joystick button on the bottom of the monitor to turn on the monitor.

CAUTION

- Unplug the power cord before moving or installing the monitor. There is risk of electric shock.

Cautions When Connecting Power Cord

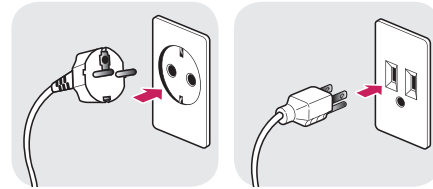

100-240 V ~

- Make sure to use the power cord that is provided in the product package and connect it to a grounded power outlet.
- If you need another power cord, please contact your local dealer or the nearest retail store.

Adjusting the Stand Height

- 1 Place the monitor mounted on the stand base in an upright position.
- 2 Handle the monitor with both hands for safety.

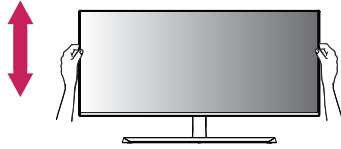

Max 110.0 mm
(4.3 inches)

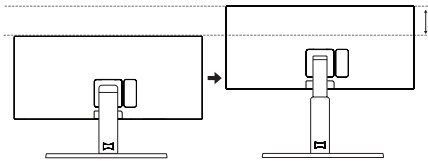

WARNING

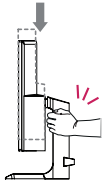

- When adjusting the screen height, do not place your hand on the stand body to avoid injury to your fingers.

Adjusting the Angle

- 1 Place the monitor mounted on the stand base in an upright position.
 - 2 Adjust the angle of the screen.
- The angle of the screen can be adjusted forward or backward from -5° to 15° for a comfortable viewing experience.

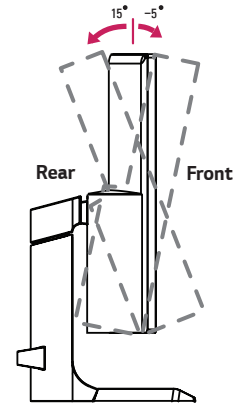

! WARNING

- To avoid injury to the fingers when adjusting the screen, do not hold the lower part of the monitor's frame as illustrated below.

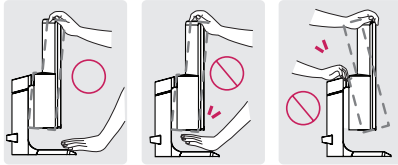

- Be careful not to touch or press the screen area when adjusting the angle of the monitor.

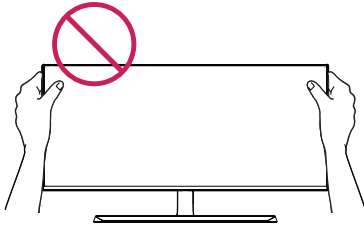
**! NOTE**

- The left or right side of the monitor head can be slightly rotated up or down (up to 3°). Adjust the horizontal level of the monitor head.

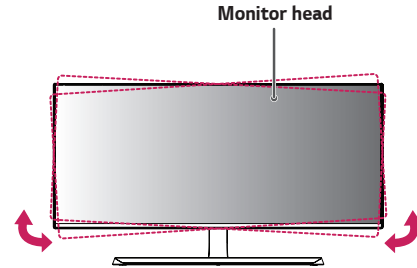

Tidying up Cables

Arrange the cables using the cable holder as shown in the illustration.

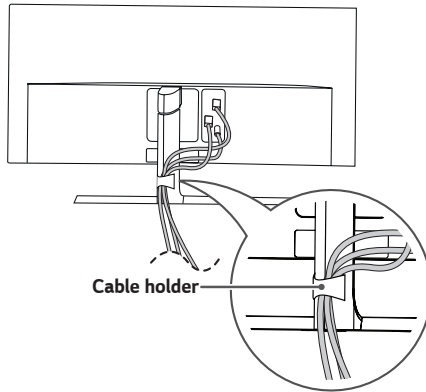

Using the Kensington Lock

The connector for the Kensington security system is located at the bottom of the monitor.

For more information on installation and usage, refer to the Kensington lock owner's manual or visit the website at <http://www.kensington.com>.

Connect the monitor to a table using the Kensington security system cable.

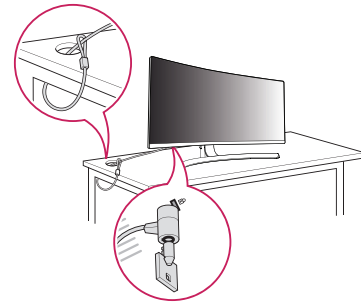

! NOTE

- The Kensington security system is optional. You can obtain optional accessories from most electronics stores.

Detaching the Stand Body

- 1 Place the monitor's screen face down. To protect the screen from scratches, cover the surface with a soft cloth.
- 2 Remove the stand from the monitor by pressing the button on the bottom center of the back of the monitor.

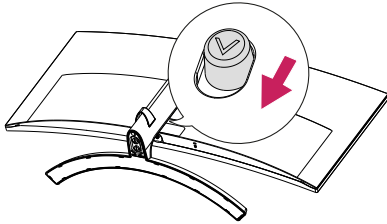

Installing the Wall Mount Plate

This monitor meets the specifications for the wall mount plate or other compatible devices.

- 1 Place the screen face down. To protect the monitor panel (screen), cover the surface with a soft cloth or the monitor protection pad included in the product package.
- 2 Remove the four screws tightened on the back of the monitor.
- 3 Place the wall mount plate onto the monitor and align it with the screw holes.
- 4 Tighten the four screws using a screwdriver to fix the plate to the monitor.

! NOTE

- The wall mount plate is sold separately.
- For more information on installation, refer to the wall mount plate's installation guide.
- Be careful not to apply too much force while mounting the wall mount plate as it may cause damage to the screen.

Installing on the Wall

Install the monitor at least 100 mm (3.9 inches) away from the wall and leave about 100 mm (3.9 inches) of space at each side of the monitor to ensure sufficient ventilation. Detailed installation instructions can be obtained from your local retail store. Alternatively, please refer to the manual for how to install and set up a tilting wall mounting bracket.

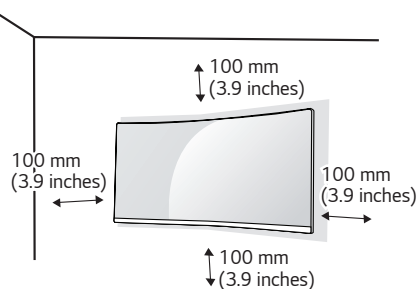

To install the monitor to a wall, attach a wall mounting bracket (optional) to the back of the monitor.

Make sure that the wall mounting bracket is securely fixed to the monitor and to the wall.

- 1 If you use screws longer than the standard length, it may damage the inside of the product.
- 2 A non-VESA standard screw may damage the product and cause the monitor to fall. LG Electronics is not liable for any accidents relating to the use of non-standard screws.

Wall Mount (mm)	100 x 100
Stand Screw	M4 x L10
Required Screws	4
Wall Mount Plate (Optional)	RW120

NOTE

- Use the screws specified by VESA standards.
- The wall mount kit includes the installation guide and all necessary parts.
- The wall mounting bracket is optional. You can obtain optional accessories from your local dealer.
- The length of the screw may differ for each wall mounting bracket. Be sure to use the proper length.
- For more information, please refer to the user manual for the wall mounting bracket.

CAUTION

- Unplug the power cord before moving or installing the monitor to avoid electric shock.
- Installing the monitor on the ceiling or on a slanted wall may result in the monitor falling off, which could lead to injury. Use an authorized LG wall mount and contact the local dealer or qualified personnel.
- Applying excessive force when tightening screws may cause damage to the monitor. Damage caused in this way will not be covered by the product warranty.

- Use the wall mounting bracket and screws that conform to VESA standards. Damage caused by the use or misuse of inappropriate components will not be covered by the product warranty.
- When measured from the back of the monitor, the length of each installed screw must be 8 mm (0.3 inches) or less.

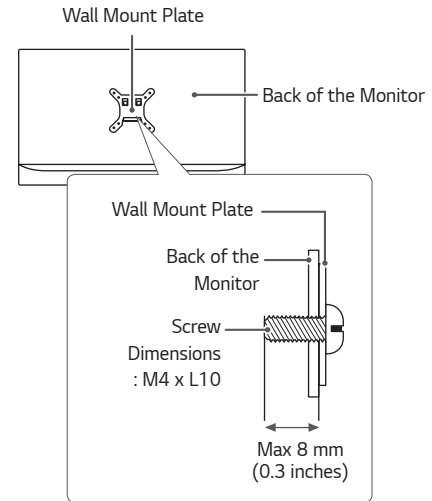

USING THE MONITOR

- The following instructions are based on the 38UC99 model. Illustrations in this manual may differ from the actual product.

Press the joystick button, go to **Menu** → **Input**, and then select the input option.



CAUTION

- Do not press the screen for a prolonged time. This may cause image distortion.
- Do not display a still image on the screen for a prolonged time. This may cause image retention. Use a screensaver if possible.



NOTE

- When connecting the power cord to the outlet, use a grounded (3-hole) power strip or a grounded power outlet.
- The monitor may flicker when turned on in an area where the temperature is low. This is normal.
- Sometimes red, green, or blue spots may appear on the screen. This is normal.

Connecting to a PC

- This monitor supports the *Plug and Play feature.
- * Plug and Play: A feature that allows you to add a device to your computer without having to reconfigure anything or install any manual drivers.

HDMI Connection

Transmits digital video and audio signals from your PC to the monitor. Connect your PC to the monitor using the HDMI cable as shown in the illustration below.

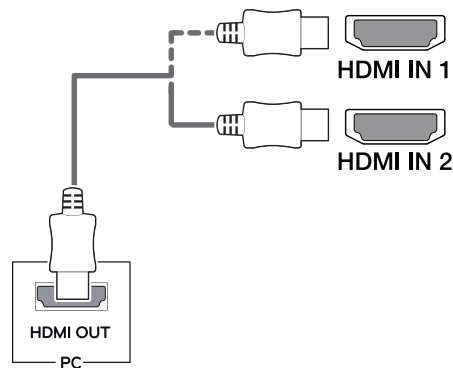



CAUTION

- Make sure to use the supplied HDMI cable of the product. Otherwise, this may cause the device to malfunction.
- Connecting your PC to the monitor using the HDMI cable may cause device compatibility issues.
- Using a DVI to HDMI / DP (DisplayPort) to HDMI cable may cause compatibility issues.
- Use a certified cable with the HDMI logo attached. If you do not use a certified HDMI cable, the screen may not display or a connection error may occur.
- Recommended HDMI cable types
 - High-Speed HDMI^{®/TM} cable
 - High-Speed HDMI^{®/TM} cable with Ethernet

DisplayPort Connection

Transmits digital video and audio signals from your PC to the monitor. Connect the monitor to your PC using the DisplayPort cable as shown in the illustration below.

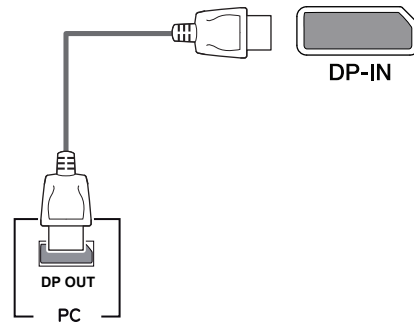

NOTE

- There may be no video or audio output depending on the DP (DisplayPort) version of the PC.
- Make sure to use the supplied DisplayPort cable of the product. Otherwise, this may cause the device to malfunction.
- For using Mini DP to DP (Mini DisplayPort to DisplayPort) cable, it is recommended that you use DisplayPort 1.2 cable.

USB-C connection

Transmits digital video and audio signals and USB data from your PC to the monitor. Connect the monitor to your PC using the USB-C cable as shown in the illustration below. Press the menu button and then select the input option from the input menu.

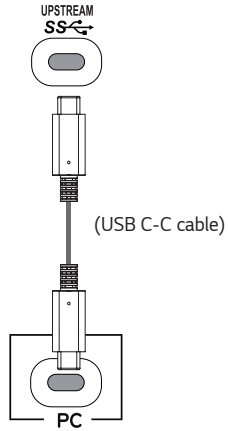

! NOTE

- PD (Power Delivery), DP Alternate Mode (DP over USB-C) and USB Data are supported via USB-C Port.
- Features may not work properly depending on the connected device's specifications and the environment.
- USB-C port is not for the Monitor Power source but for a PC power source. Connect Adapter to supply power to the Monitor.

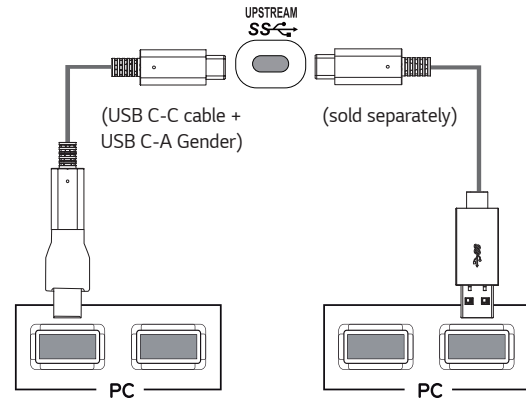

Connecting AV Devices

HDMI Connection

HDMI transmits digital video and audio signals from your AV device to the monitor. Connect your AV device to the monitor using the HDMI cable as shown in the illustration below.

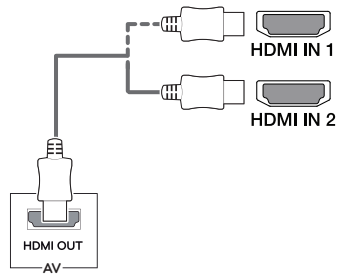

NOTE

- Make sure to use the supplied HDMI cable of the product. Otherwise, this may cause the device to malfunction.
- Using a DVI to HDMI / DP (DisplayPort) to HDMI cable may cause compatibility issues.
- Use a certified cable with the HDMI logo attached. If you do not use a certified HDMI cable, the screen may not display or a connection error may occur.
- Recommended HDMI cable types
 - High-Speed HDMI[®]/TM cable
 - High-Speed HDMI[®]/TM cable with Ethernet

Connecting Peripherals

USB Cable connection

The USB port on the product functions as a USB hub.

Please connect the **USB C-C cable** or **USB C-C cable + USB C-A gender** to the PC. To use USB 3.0, connect the **USB C-C cable + USB C-A gender** of the product to the PC.

Peripheral devices connected to the USB IN port can be controlled from the PC.

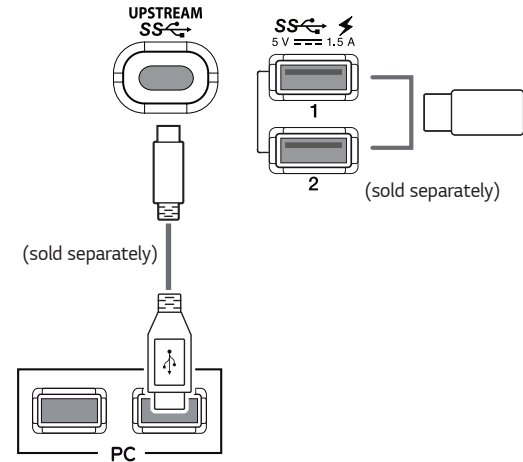

! NOTE

- Make sure to install the most recent Windows OS service pack before using the product.
- Peripheral devices are sold separately.
- A keyboard, mouse, or USB device can be connected to the USB port.
- **Quick Charge** is available through the USB1 and USB2 port.
- When the Monitor is gone to Power off, **Quick Charge** is not available.
- The charging speed may vary depending on the device.

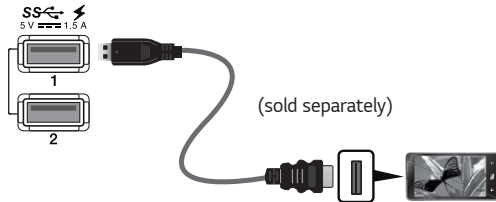

! CAUTION

Cautions When Using a USB Device

- A USB device with an automatic recognition program installed, or that uses its own driver, may not be recognized.
- Some USB devices may not be supported or may not work properly.
- It is recommended to use a USB hub or hard disk drive with power supplied. (If the power supply is not adequate, the USB device may not be recognized properly.)

Connecting Headphones

Connect peripherals to the monitor via the headphones port. Connect as illustrated.

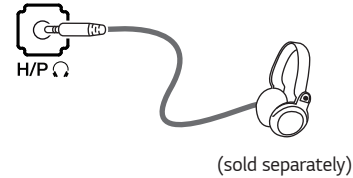

! NOTE

- Peripheral devices are sold separately.
- If you use angled earphones, it may cause a problem with connecting another external device to the monitor. Therefore, it is recommended to use straight earphones.



Angled

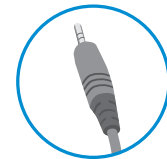

Straight

- Depending on the audio settings of the PC and external device, headphones and speaker functions may be limited.

Service only port

The port is used only for "Service".

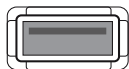

SERVICE ONLY

USER SETTINGS

Activating the Main Menu

- 1 Press the joystick button on the bottom of the monitor.
- 2 Move the joystick up/down (▲ / ▼) and left/right (◀ / ▶) to set the options.
- 3 Press the joystick button once more to exit the main menu.

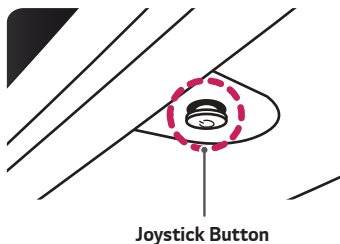

Button	Menu Status	Description
	Main menu disabled	Enables the main menu.
	Main menu enabled	Exits the main menu. (Holding down the button to turn off the monitor. You can turn off the monitor this way at any time, including when the OSD is on.)
	◀ Main menu disabled	Adjusts the monitor volume level.
	◀ Main menu enabled	Enters the Input features.
	▶ Main menu disabled	Adjusts the monitor volume level.
	▶ Main menu enabled	Enters the Menu feature.
	▲ Main menu disabled	Displays the information on the current input.
	▲ Main menu enabled	Turns off the monitor.
	▼ Main menu disabled	Displays the information on the current input.
	▼ Main menu enabled	Enters the Bluetooth Audio feature.

Main Menu Features

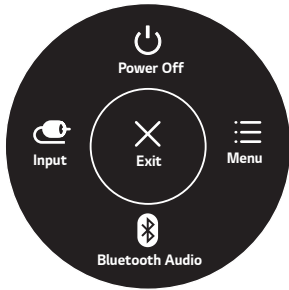

Main Menu	Description
Input	Sets input mode.
Power Off	Turns off the monitor.
Menu	Configures the screen settings.
Bluetooth Audio	Reconnects to previously connected Bluetooth devices or disconnects from already connected Bluetooth devices.
Exit	Exits the main menu.

User Settings

Menu Settings

- 1 To view the OSD menu, press the joystick button at the bottom of the monitor and then enter the **Menu**.
 - 2 Configure the options by moving the joystick up/down/left/right.
 - 3 To return to the upper menu or set other menu items, move the joystick to ◀ or by pressing (Ⓞ / Ok).
 - 4 If you want to exit the OSD menu, move the joystick to ◀ until you exit.
- When you enter the menu, instructions on how to use the button will appear in the bottom right corner of the screen.



Quick Settings



Input



Picture



Sound



General

Each option is described below.

Menu		Description
Quick Settings	Brightness	Adjusts the color contrast and brightness of the screen.
	Contrast	
	Volume	Adjusts the volume level.  NOTE <ul style="list-style-type: none"> You can adjust Mute / Unmute by moving the joystick button to ▼ in the Volume menu. The available minimum and maximum volumes for Bluetooth Audio depend on the monitor's OSD volume.
	Screen Off	Turns off the monitor's backlight and plays only the audio from the connected input or Bluetooth device.
	Bluetooth Audio	Reconnects to previously connected Bluetooth devices or disconnects from already connected Bluetooth devices.
Input	Main Input List	Selects the input mode.
	Aspect Ratio	Adjusts the aspect ratio of the screen.
	PBP	Displays the screens of two input modes on one monitor.
	Main/ Sub Screen Change	Toggles between the main screen and sub screen in PBP mode.
	Main/ Sub Sound Change	Toggles between the audio of the main screen and sub screen in PBP mode.
	Auto Input Switch	When automatic input switch is set to On , display will automatically switch to new input when connected.

Picture	Picture Mode	Changes the picture mode to the one optimized for a given feature.
	Picture Adjust	Adjusts the Brightness, Contrast, Sharpness, SUPER RESOLUTION+, Black Level , and DFC .
	Game Adjust	Adjusts the Response Time, FreeSync, Black Stabilizer , and 1ms Motion Blur Reduction .
	Color Adjust	Adjusts the Gamma, Color Temp, Red, Green, Blue , and Six Color .
	Screen Off	Turns off the monitor's backlight and plays only the audio from the connected input or Bluetooth device.
	Picture Reset	Returns picture to the default settings.
Sound		Adjusts the Volume , and Bluetooth Audio Mode .
General		Sets Language, SMART ENERGY SAVING, Power LED, Automatic Standby, HDMI Compatibility Mode, DisplayPort 1.2, Quick Charge, OSD Lock , and Reset .
◀	Exit	Exits the OSD menu.

**CAUTION**



- Your monitor's OSD (On Screen Display) may differ slightly from that shown in this manual.

Quick Settings

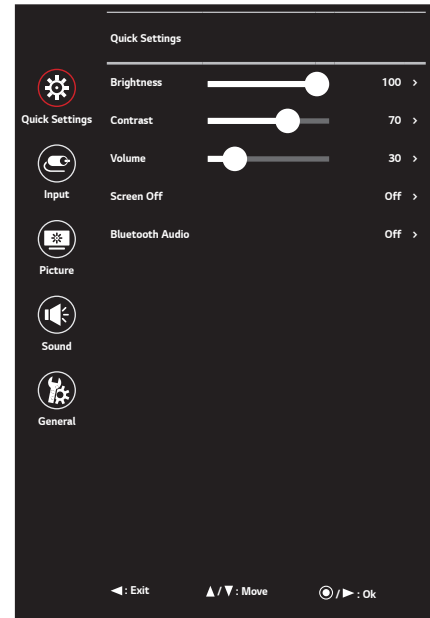
- 1 To view the OSD menu, press the joystick button at the bottom of the monitor and then enter the **Menu**.
- 2 Go to **Quick Settings** by moving the joystick.
- 3 Configure the options following the instructions that appear in the bottom right corner.
- 4 To return to the upper menu or set other menu items, move the joystick to ◀ or by pressing (⊙ / Ok).
- 5 If you want to exit the OSD menu, move the joystick to ◀ until you exit.



Each option is described below.

Menu > Quick Settings	Description
Brightness	Adjusts the color contrast and brightness of the screen.
Contrast	
Volume	<p>Adjusts the volume level.</p> <p> NOTE</p> <ul style="list-style-type: none"> • You can adjust Mute / Unmute by moving the joystick button to ▼ in the Volume menu. • The available minimum and maximum volumes for Bluetooth Audio depend on the monitor's OSD volume.
Screen Off	<p>Turns off the monitor's backlight and plays only the audio from the connected input or Bluetooth device. The audio continues to play even after the screen turns off.</p> <p> NOTE</p> <ul style="list-style-type: none"> • To turn the screen back on, press the joystick button on the bottom of the monitor.
Bluetooth Audio	<p>Reconnects to previously connected Bluetooth devices or disconnects from already connected Bluetooth devices.</p> <p> NOTE</p> <ul style="list-style-type: none"> • The monitor can only reconnect if it was previously connected to a Bluetooth device.

Input

- 1 To view the OSD menu, press the joystick button at the bottom of the monitor and then enter the **Menu**.
- 2 Go to **Input** by moving the joystick.
- 3 Configure the options following the instructions that appear in the bottom right corner.
- 4 To return to the upper menu or set other menu items, move the joystick to ◀ or by pressing (⊙ / Ok).
- 5 If you want to exit the OSD menu, move the joystick to ◀ until you exit.

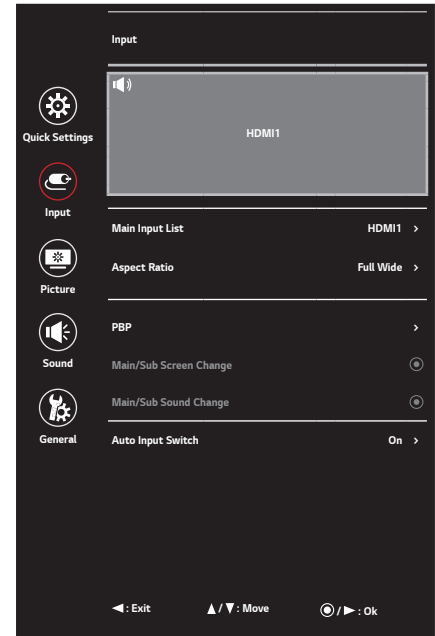

Each option is described below.

Menu > Input	Description	
Main Input List	Selects the input mode.	
Aspect Ratio	Adjusts the aspect ratio of the screen.	
	Full Wide	Displays the video in widescreen, regardless of the video signal input.
	Original	Displays video according to the aspect ratio of the video signal input.
	1:1	The aspect ratio is not adjusted from the original.
	Cinema1	Enlarges the screen with an aspect ratio of 21:9. (at 1080p)
	Cinema2	Enlarges the screen with an aspect ratio of 21:9, including the black box at the bottom for subtitles. (at 1080p)
	 NOTE <ul style="list-style-type: none"> • The display may look the same for Full Wide, Original, and 1:1 options at the recommended resolution (3840 x 1600). • There is no 1:1, Cinema1, Cinema2 menu on FreeSync Mode. (Go to Picture → Game Adjust → FreeSync, to set FreeSync On or Off) 	
PBP	Displays the screens of two input modes on one monitor.	
Main/Sub Screen Change	Toggles between the main screen and sub screen in PBP mode.	
Main/Sub Sound Change	Toggles between the audio of the main screen and sub screen in PBP mode.	
Auto Input Switch	When automatic input switch is set to On , display will automatically switch to new input when connected.	

[PBP]

Menu > Input	Description					
Input List	Displays the screens of two input modes on one monitor.					
	Main Input List	PBP combinations are not supported between HDMI inputs or DisplayPort inputs.				
	Sub Input List					
	PBP Connection		Sub Screen (Right)			
			HDMI 1	HDMI 2	DisplayPort	USB-C
	Main Screen (Left)	HDMI 1	X	X	O	O
HDMI 2		X	X	O	O	
DisplayPort		O	O	X	X	
USB-C		O	O	X	X	
Aspect Ratio	Adjusts the aspect ratio of the screen.					
	Main Aspect Ratio	Full Wide	Displays the video to fit the PBP screen, regardless of the video signal input.			
		Original	Displays the video in the aspect ratio of the video signal input on the PBP screen.			
	Sub Aspect Ratio	Full Wide	Displays the video to fit the PBP screen, regardless of the video signal input.			
Original		Displays the video in the aspect ratio of the video signal input on the PBP screen.				
PBP	You can disable the feature that displays images from two input modes simultaneously on one monitor.					
Main/Sub Screen Change	Toggles between the main screen and sub screen in PBP mode.					
Main/Sub Sound Change	Toggles between the audio of the main screen and sub screen in PBP mode.					
Auto Input Switch	When automatic input switch is set to On , display will automatically switch to new input when connected.					

**NOTE**

- If not using the **PBP** feature, **Main/Sub Screen Change** and **Main/Sub Sound Change** are deactivated.

Picture

- 1 To view the OSD menu, press the joystick button at the bottom of the monitor and then enter the **Menu**.
- 2 Go to **Picture** by moving the joystick.
- 3 Configure the options following the instructions that appear in the bottom right corner.
- 4 To return to the upper menu or set other menu items, move the joystick to ◀ or by pressing (⊙ / Ok).
- 5 If you want to exit the OSD menu, move the joystick to ◀ until you exit.

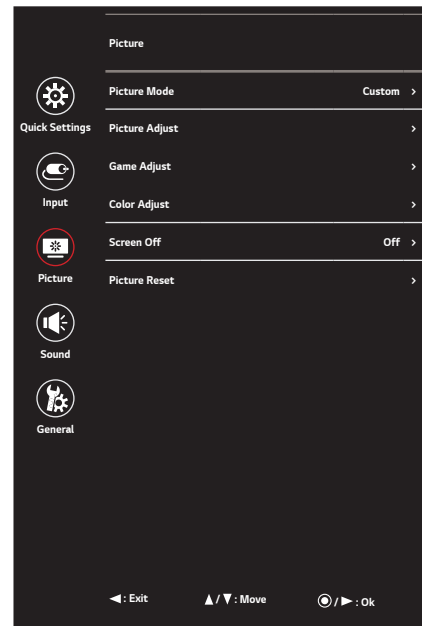

Each option is described below.

Menu > Picture	Description	
Picture Mode	Custom	Allows the user to adjust each element. The color mode of the main menu can be adjusted.
	Reader	Optimizes the screen for viewing documents. You can brighten the screen in the OSD menu.
	Photo	Optimizes the screen for photos.
	Cinema	Optimizes the screen for video.
	Dark Room 1	This mode adjusts the brightness to the optimal level for working in a dark environment.
	Dark Room 2	This mode sets the brightness to a lower level than Dark Room 1 .
	Color Weakness	This mode is for users who cannot distinguish between red and green. It enables users with color weakness to easily distinguish between the two colors.
	FPS Game 1	This mode is optimized for FPS games.
	FPS Game 2	It has a higher Black Stabilizer value than FPS Game 1 . It is suitable for very dark FPS games.
	RTS Game	This mode is optimized for RTS Game.
	Custom (Game)	In this mode, users can customize various elements including game-related options.
<div data-bbox="252 692 300 736"></div> <div data-bbox="306 703 370 730">NOTE</div> <ul data-bbox="242 748 1372 770" style="list-style-type: none"> • If the Picture Mode is changed in the DP (DisplayPort) input, the screen may flicker or the resolution of your PC screen may be affected. 		

Menu > Picture		Description		
Picture Adjust	Brightness	Adjusts the color contrast and brightness of the screen.		
	Contrast			
	Sharpness	Adjusts the sharpness of the screen.		
	SUPER RESOLUTION+	High	Optimizes the screen for crystal clear images. Best for high-definition video or games.	
		Middle	Optimizes the screen for comfortable viewing, with images at the middle level between the low and high modes. Best for UCC or SD videos.	
		Low	Optimizes the screen for smooth and natural images. Best for still images or images with less movement.	
		Off	Displays in the most common setting. Disables SUPER RESOLUTION+ .	
			 NOTE <ul style="list-style-type: none"> Because this is a function to increase the sharpness of low resolution pictures, it is not recommended to use the function for normal text or for desktop icons. Doing so may result in unnecessarily high sharpness. 	
	Black Level	Sets the offset level (for HDMI only).		
		<ul style="list-style-type: none"> Offset: as a reference for a video signal, this is the darkest color the monitor can display. 		
		High	Keeps the current contrast ratio of the screen.	
	Low	Lowers the black levels and raises the white levels from the current contrast ratio of the screen.		
DFC	On	Adjusts the brightness automatically according to the screen.		
	Off	Disables the DFC feature.		

Menu > Picture	Description		
Game Adjust	Response Time	<p>Sets a response time for displayed pictures based on the speed of the screen. For a normal environment, it is recommended that you use Normal. For a fast-moving picture, it is recommended that you use Fast. Setting to Fast may cause image sticking.</p>	
		Fast	Sets the response time to high.
		Normal	Sets the response time to middle.
		Slow	Sets the response time to low.
		Off	Does not use the response time improvement feature.
	FreeSync	<p>Provides seamless and natural images by synchronizing the vertical frequency of the input signal with that of the output signal.</p> <p> CAUTION</p> <ul style="list-style-type: none"> Supported Interface: DisplayPort Supported Graphic Card: A graphic card that supports AMD's FreeSync is necessary. Supported Version: Make sure to update the graphic card to the latest driver. For more information and requirement, refer to AMD website at http://www.amd.com/FreeSync. 	
		On	FreeSync function on.
		Off	FreeSync function off.

Menu > Picture	Description		
Game Adjust	Black Stabilizer	<p>You can control the black contrast to have better visibility in dark scenes.</p> <p>Increasing the Black Stabilizer value brightens the low gray level area on the screen. (You can easily distinguish objects on dark game screens.)</p> <p>Reducing the Black Stabilizer value darkens the low gray level area and increases the dynamic contrast on the screen.</p>	
	1ms Motion Blur Reduction	On	<p>This mode minimizes motion blur in fast-moving videos. This function only works for frame rates (vertical frequency) of 75 Hz. To take full advantage of this function, select 3840 x 1600 @ 75 Hz for DisplayPort (DP) or HDMI inputs before enabling 1ms Motion Blur Reduction.</p> <div data-bbox="900 423 1257 553" data-label="Image"> </div> <p>This function is available for 75 Hz only.</p>
		Off	<p>Turns 1ms Motion Blur Reduction Mode off.</p> <div data-bbox="900 647 1257 777" data-label="Image"> </div>
	<p>! NOTE</p> <ul style="list-style-type: none"> • To reduce motion blur, brightness is reduced with backlight control. • 1ms Motion Blur Reduction and FreeSync cannot be enabled simultaneously. • This function is game-optimized. • It is recommended to turn off when you are not using the gaming function. 		

Menu > Picture	Description		
Color Adjust	Gamma	Custom gamma settings: Gamma 0 , Gamma 1 , Gamma 2 . The higher the gamma value, the darker the image becomes. Likewise, the lower the gamma value, the lighter the image becomes.	
	Color Temp	Custom	The user can adjust it to red, green, or blue by customization.
		Warm	Sets the screen color to a reddish tone.
		Medium	Sets the screen color to between a red and blue tone.
		Cool	Sets the screen color to a bluish tone.
	Red	You can customize the picture color using Red , Green , and Blue colors.	
	Green		
	Blue		
	Six Color	Meets the user requirements for colors by adjusting the hue and saturation of the six colors (red, green, blue, cyan, magenta, and yellow) and then saving the settings.	
		Hue	Adjusts the tone of the screen colors.
Saturation		Adjusts the saturation of the screen colors. The lower the value, the less saturated and brighter the colors become. The higher the value, the more saturated and darker the colors become.	
Screen Off	Turns off the monitor's backlight and plays only the audio from the connected input or Bluetooth device.		
Picture Reset	Returns picture to the default settings.		

Sound

- 1 To view the OSD menu, press the joystick button at the bottom of the monitor and then enter the **Menu**.
- 2 Go to **Sound** by moving the joystick.
- 3 Configure the options following the instructions that appear in the bottom right corner.
- 4 To return to the upper menu or set other menu items, move the joystick to ◀ or by pressing (⊙ / Ok).
- 5 If you want to exit the OSD menu, move the joystick to ◀ until you exit.

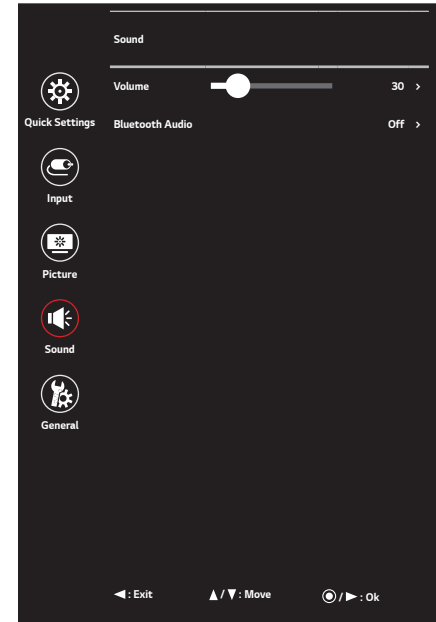

Each option is described below.

Menu > Sound	Description	
Volume	Adjusts the volume level.  NOTE <ul style="list-style-type: none"> • You can adjust Mute / Unmute by moving the joystick button to in the Volume menu. • The available minimum and maximum volumes for Bluetooth Audio depend on the monitor's OSD volume. 	
Bluetooth Audio	On	Connects to a previously connected Bluetooth device.
	Off	Disconnects from an already connected Bluetooth device.

 **NOTE**

- If there is no input signal while a Bluetooth device is connected, a message is displayed for 10 minutes.
- If there is no input signal while a Bluetooth device is streaming, the monitor will not enter the power-saving mode and remain off.

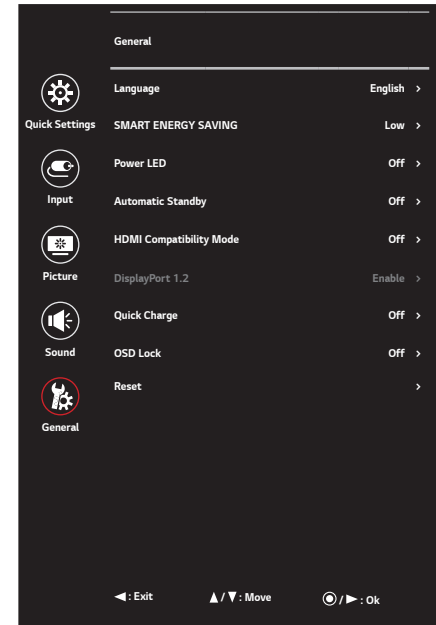

General

- 1 To view the OSD menu, press the joystick button at the bottom of the monitor and then enter the **Menu**.
- 2 Go to **General** by moving the joystick.
- 3 Configure the options following the instructions that appear in the bottom right corner.
- 4 To return to the upper menu or set other menu items, move the joystick to ◀ or by pressing (⊙ / Ok).
- 5 If you want to exit the OSD menu, move the joystick to ◀ until you exit.



Each option is described below.

Menu > General	Description	
Language	Sets the menu screen to the desired language.	
SMART ENERGY SAVING	Conserve energy by using luminance compensation algorithm.	
	High	Saves energy using the high-efficiency SMART ENERGY SAVING feature.
	Low	Saves energy using the low-efficiency SMART ENERGY SAVING feature.
	Off	Disables the SMART ENERGY SAVING feature.
Power LED	Turns the power LED on the front of the monitor On or Off .	
	On	The power LED turns on automatically.
	Off	The power LED turns off.
Automatic Standby	Feature that automatically turns off the monitor when there is no movement on the screen for a period of time. You can set a timer for the auto-off function. (Off , 4 H , 6 H , and 8 H)	
HDMI Compatibility Mode	HDMI Compatibility Mode feature can recognize the legacy equipment that does not support HDMI 2.0.	
	On	Enables HDMI Compatibility Mode .
	Off	Disables HDMI Compatibility Mode .
DisplayPort 1.2	Enables or disables DisplayPort 1.2 .  NOTE <ul style="list-style-type: none"> • Be sure to configure this option according to the DisplayPort version supported by your graphic card. Set this option to Disable if your graphic card does not support DisplayPort 1.2. 	

Menu > General	Description	
Quick Charge	Quick Charge is a feature that rapidly charges the device connected to the USB 3.0 port.	
	On	Enables Quick Charge .
	Off	Disables Quick Charge .
	 NOTE <ul style="list-style-type: none"> The charging speed may vary depending on the device. 	
OSD Lock	This feature disables the configuration and adjustment of menus.	
	On	Enables OSD Lock .
	Off	Disables OSD Lock .
	 NOTE <ul style="list-style-type: none"> All features are disabled except Brightness, Contrast, Volume in Quick Settings, Input and OSD Lock in General. 	
Reset	Do you want to reset your settings?	
	No	Cancel the reset.
	Yes	Restores the default settings.

 **NOTE**

- Saving Data depends on the Panel. These values vary by panel and vendor. If the option of SMART ENERGY SAVING is set High or Low, monitor luminance becomes higher or lower depending upon the source.

TROUBLESHOOTING

Nothing is displayed on the screen.	
Is the monitor's power cord plugged in?	<ul style="list-style-type: none"> • Check if the power cord is correctly plugged into the power outlet.
Is the power LED on?	<ul style="list-style-type: none"> • Check the power cable connection and press the power button.
Is the power on and the power LED displaying white?	<ul style="list-style-type: none"> • Check that the connected input is enabled (Menu > Input).
Is the power LED blinking?	<ul style="list-style-type: none"> • If the monitor is in sleep mode, move the mouse, or press any key on the keyboard, to switch the display on. • Check if the computer is turned on.
Is the OUT OF RANGE message being displayed?	<ul style="list-style-type: none"> • This occurs when signals transferred from the PC (graphic card) are out of the horizontal or vertical frequency range of the monitor. Please see the Product Specification section of this manual to set the appropriate frequency.
Is the No Signal message being displayed?	<ul style="list-style-type: none"> • This is displayed when the signal cable between the PC and the monitor is missing or disconnected. Check the cable and reconnect it.
The screen may not be displayed properly when configuring DisplayPort 1.2 in a Mac product.	<ul style="list-style-type: none"> • DisplayPort 1.2 may not be supported depending upon the Mac product. Please contact the manufacturer.

The OSD Lock message is being displayed.	
Are some functions not available when you press the Menu button?	<ul style="list-style-type: none"> • The OSD is locked. Go to Menu > General and set OSD Lock to Off.

The screen retains an image.

Does image sticking occur even when the monitor is turned off?

- Displaying a still image for a prolonged time may cause damage to the screen, resulting in the retention of the image.
- To extend the lifetime of the monitor, use a screensaver.

Screen display is unstable and shaky. / Images displayed on the monitor leave shadow trails.

Did you select the appropriate resolution?

- If the selected resolution is HDMI 1080i 60/50 Hz (interlaced), the screen may be flickering. Change the resolution to 1080p or the recommended resolution.

**NOTE**



- Vertical Frequency: In order to display an image, the screen must be refreshed dozens of times per second, like a fluorescent lamp. The number of times the screen is refreshed per second is called vertical frequency, or refresh rate, and is represented by Hz.
- Horizontal Frequency: The time it takes to display one horizontal line is called the horizontal cycle. If 1 is divided by the horizontal interval, the result is the number of horizontal lines displayed per second. This is called horizontal frequency and is represented by kHz.
- Check if the graphic card's resolution or frequency is within the range allowed by the monitor and set it to the recommended (optimal) resolution **Control Panel > Display > Settings** in Windows. (The settings may differ depending on the operating system (OS) you use.)
- Not setting the graphic card to the recommended (optimal) resolution may result in blurred text, a dimmed screen, a truncated display area or misalignment of the display.
- The setting methods may be different depending on the computer or operating system, and some resolutions may not be available depending on the performance of the graphic card. If this is the case, contact the manufacturer of the computer or graphic card for assistance.
- Some graphic cards may not support 3840 x 1600 resolution. If the resolution cannot be displayed, contact the manufacturer of your graphic card.

The display color is abnormal.	
Does the display appear discolored (16 colors)?	<ul style="list-style-type: none"> • Set the color to 24 bit (true color) or higher. In Windows, go to Control Panel > Display > Settings > Color Quality. (The settings may differ depending on the operating system (OS) you use.)
Does the display color appear unstable or monochrome?	<ul style="list-style-type: none"> • Check if the signal cable is connected properly. Reconnect the cable or reinsert the PC's graphic card.
Are there spots on the screen?	<ul style="list-style-type: none"> • When using the monitor, pixilated spots (red, green, blue, white, or black) may appear on the screen. This is normal for an LCD screen. It is not an error, nor is it related to the monitor's performance.

Do you see an "Unrecognized monitor, Plug and Play (VESA DDC) monitor found" message?	
Have you installed the display driver?	<ul style="list-style-type: none"> • Be sure to install the display driver from the display driver CD (or diskette) that comes with your display. Or, you can also download the driver from our web site: http://www.lg.com. • Make sure to check if the graphic card supports Plug and Play function.

No sound from the headphone port.	
Are images displayed using DP (DisplayPort) or HDMI input without sound?	<ul style="list-style-type: none"> • Make sure that the headphone port connections are made properly. • Try increasing the volume with the joystick. • Set the audio output of the PC to the monitor you are using. On Microsoft Windows, go to Control Panel > Hardware and Sound > Sound > set the Monitor as default device. (The settings may differ depending on the operating system (OS) you use.)

PRODUCT SPECIFICATION

LCD Screen	Type	TFT (Thin Film Transistor) LCD (Liquid Crystal Display) Screen	
	Color Depth	HDMI	8-bit color is supported.
		DP (DisplayPort)	8-bit / 10-bit color is supported.
Pixel Pitch	0.22908 mm x 0.22908 mm		
Resolution	Max Resolution	3840 x 1600 @ 75 Hz	
	Recommended Resolution	3840 x 1600 @ 60 Hz	
Video Signal	Horizontal Frequency	30 kHz to 125 kHz	
	Vertical Frequency	56 Hz to 75 Hz	
	Synchronization	Separate Sync.	
Input Connector	H/P OUT, HDMI IN 1/2, DP (DisplayPort) IN, USB  1/2, USB-C (UPSTREAM)		
Power Sources	Power Rating	19 V  7.7 A	
	Power Consumption (Typical)	Operating Mode: 70 W (Typical, USB excluded) (Outgoing condition)* 48 W (ENERGY STAR® standard)** Sleep Mode: ≤ 1.2 W Off Mode: ≤ 0.3 W	
AC/DC Adapter	DA-180C19 type, manufactured by APD Output: 19 V  9.48 A		

Environmental Conditions	Operating Conditions	Temperature	0 °C to 40 °C (32 °F to 104 °F)
		Humidity	Less than 80 %
	Storing Conditions	Temperature	-20 °C to 60 °C (-4 °F to 140 °F)
		Humidity	Less than 85 %
Dimensions	Monitor Size (Width x Height x Depth)		
	With Stand	897.2 mm x 466.2 mm x 230.4 mm (35.3 inches x 18.3 inches x 9.0 inches)	
	Without Stand	897.2 mm x 394.0 mm x 91.5 mm (35.3 inches x 15.5 inches x 3.6 inches)	
Weight (Without Packaging)	With Stand	9.3 kg (20.5 lbs)	
	Without Stand	7.7 kg (16.9 lbs)	

Specifications are subject to change without notice.

* The Operating Mode of Power Consumption is measured with LGE test standard. (Full White pattern, Maximum resolution)

** The Power Consumption level can be different by operating condition and monitor setting.

** The Operating Mode of Power Consumption is measured with ENERGY STAR® test standard.

Factory Support Mode

(Preset Mode, HDMI/ DisplayPort/ USB-C PC)

Preset Mode	Horizontal Frequency (kHz)	Vertical Frequency (Hz)	Polarity (H/V)	Remarks
640 x 480	31.469	59.94	-/-	
800 x 600	37.879	60.317	+/+	
1024 x 768	48.363	60.0	-/-	
1152 x 864	54.347	60.05	+/+	
1280 x 720	45	60	+/+	
1280 x 1024	63.981	60.02	+/+	
1600 x 900	60.00	60.00	+/+	
1680 x 1050	65.29	59.954	-/+	
1920 x 1080	67.50	60	+/-	
1920 x 1080	83.894	74.973	+/-	
3440 x 1440	88.82	59.97	+/-	
3440 x 1440	110.77	75.05	+/-	
3840 x 1600	50.39	29.99	+/-	
3840 x 1600	102.23	59.99	+/-	
3840 x 1600	128.69	75	+/-	

HDMI Timing (Video)

Preset Mode	Horizontal Frequency (kHz)	Vertical Frequency (Hz)
640 x 480p	31.47	60
720 x 480p	31.47	60
720 x 576p	31.25	50
1280 x 720p	45	60
1280 x 720p	37.5	50
1920 x 1080p	67.5	60
1920 x 1080p	56.25	50
2560 x 1080p	56.25	60
2560 x 1080p	66	50
1920 x 1080i	28.125	50
1920 x 1080i	33.75	60

Power LED

Mode	LED Color
On Mode	White (For a few seconds)
Sleep Mode	White Blinking
Off Mode	Off

Wireless module (WB1NP6) Specifications

Bluetooth	
Frequency range	Output power (Max.)
2400 to 2483.5 MHz	10 dBm
<ul style="list-style-type: none"> As band channels can vary per country, the user cannot change or adjust the operating frequency. This product is configured for the regional frequency table. For consideration of the user, this device should be installed and operated with a minimum distance of 20 cm (7.8 inches) between the device and the body. FCC ID: BEJ9QK-DMWB1NP6 / IC: 2703H-DMWB1NP6 	



Declaration of Conformity

Trade Name: LG

Model: 38UC99

Responsible Party: LG Electronics Inc.

Address: 1000 Sylvan Ave. Englewood Cliffs NJ 07632 U.S.A

TEL: 201-266-2534

This device meets the EMC requirements for home appliances (Class B) and is intended for home usage. This device can be used in all regions. Read the owner's manual (CD) carefully and keep it at hand. Please note that the label attached to the product provides information for technical support.

Model _____

Serial No. _____

To obtain the source code under GPL, LGPL, MPL, and other open source licenses, that is contained in this product, please visit <http://opensource.lge.com>.

In addition to the source code, all referred license terms, warranty disclaimers and copyright notices are available for download.

LG Electronics will also provide open source code to you on CD-ROM for a charge covering the cost of performing such distribution (such as the cost of media, shipping, and handling) upon email request to opensource@lge.com. This offer is valid for three (3) years from the date on which you purchased the product.