

4

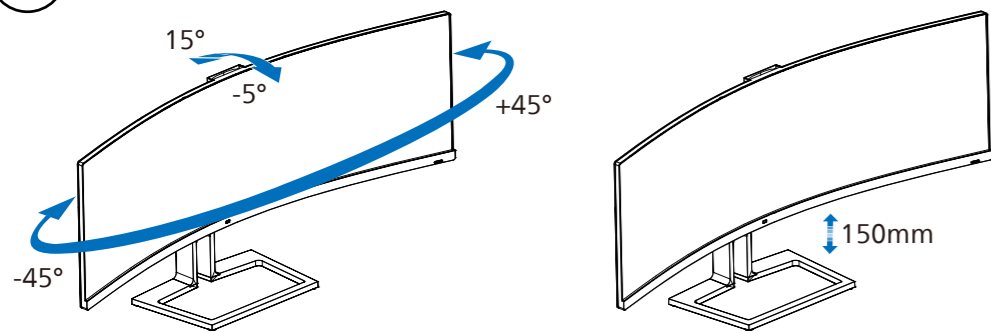

5

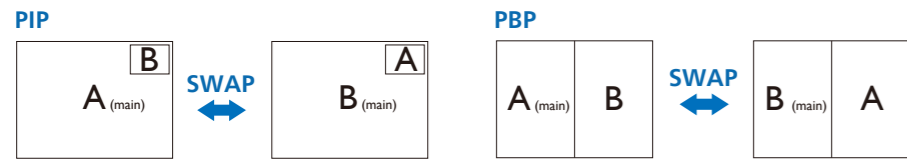
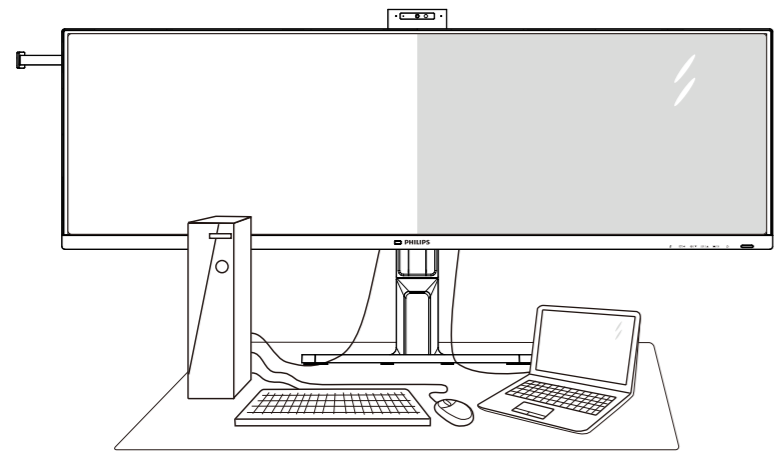

		SUB SOURCE POSSIBILITY (x1)					
MultiView		Inputs	HDMI 1	HDMI 2	DisplayPort	USBC1	USBC2
MAIN SOURCE (x1)	HDMI 1	●	●	●	●	●	●
	HDMI 2	●	●	●	●	●	●
	DisplayPort	●	●	●	●	●	●
	USBC1	●	●	●	●	●	●
	USBC2	●	●	●	●	●	●



Register your product and get support at [www.philips.com/support](http://www.philips.com/support)



Version: M1145BU6900HQ1WWT  
2022 © TOP Victory Investments Ltd. All rights reserved.

This product has been manufactured by and is sold under the responsibility of Top Victory Investments Ltd., and Top Victory Investments Ltd. is the warrantor in relation to this product. Philips and the Philips Shield Emblem are registered trademarks of Koninklijke Philips N.V. and are used under license.

Specifications are subject to change without notice.

**HDMI**  
The terms HDMI, HDMI High-Definition Multimedia Interface, HDMI Trade Dress and the HDMI Logos are trademarks or registered trademarks of HDMI Licensing Administrator, Inc.

[www.philips.com](http://www.philips.com)

Energy Labeling  
45B1U6900CH



Printed in China



Q41G45M181302A

**PHILIPS**

Curved Business Monitor

6000 Series



45B1U6900CH

# Quick start

Register your product and get support at [www.philips.com/welcome](http://www.philips.com/welcome)

## Contents

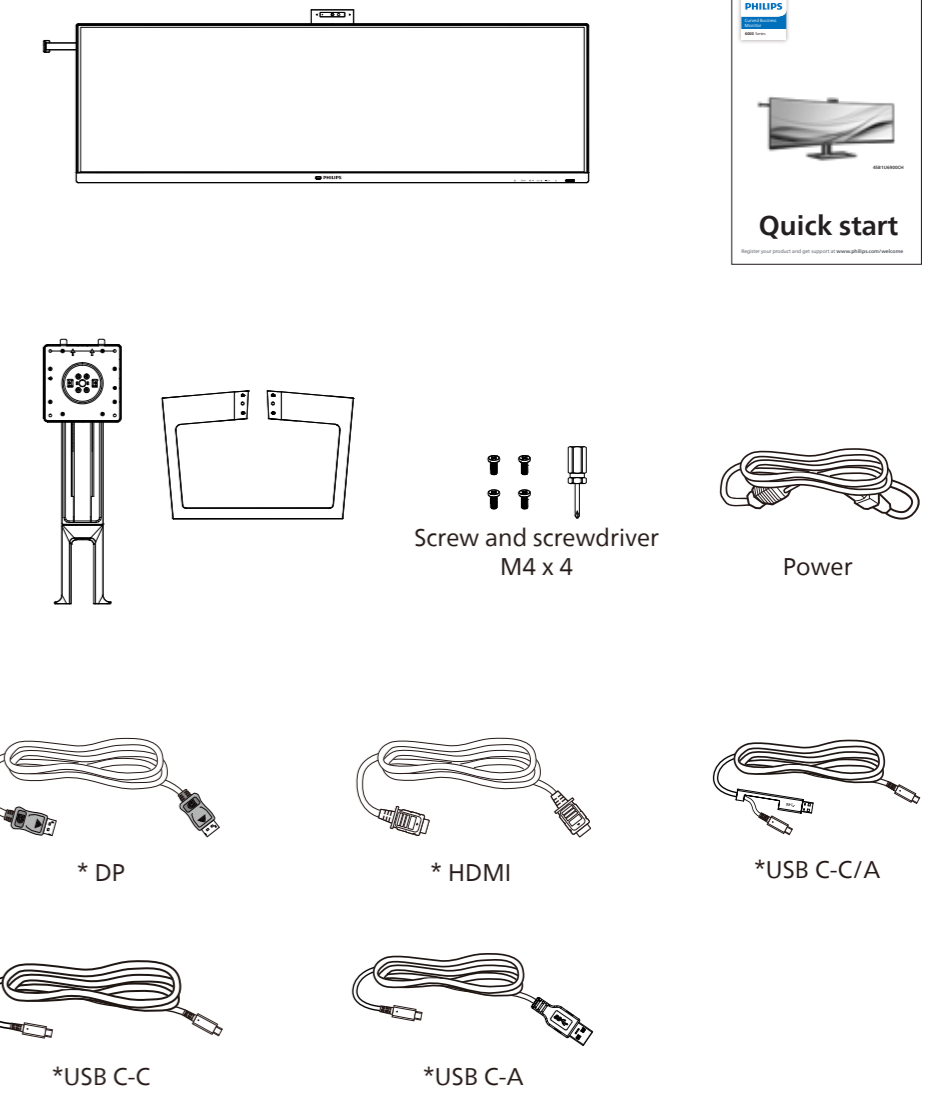

\*Different according to region  
Display design may differ from that illustrated

1

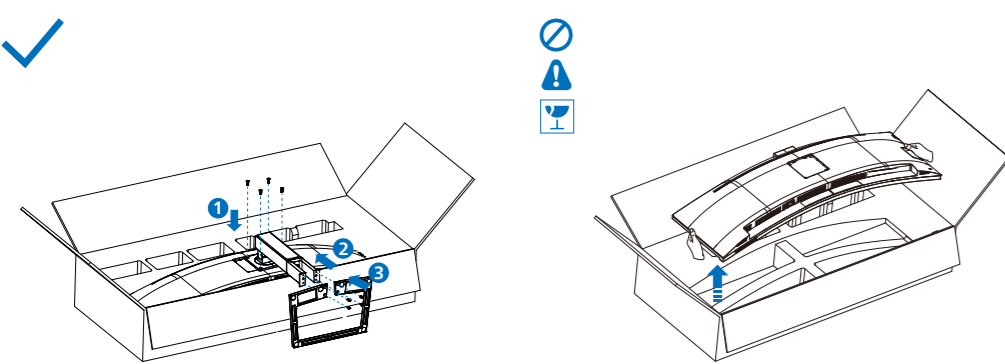

CAUTION: Place the monitor face down on a smooth surface. Pay attention not to scratch or damage the screen.

2

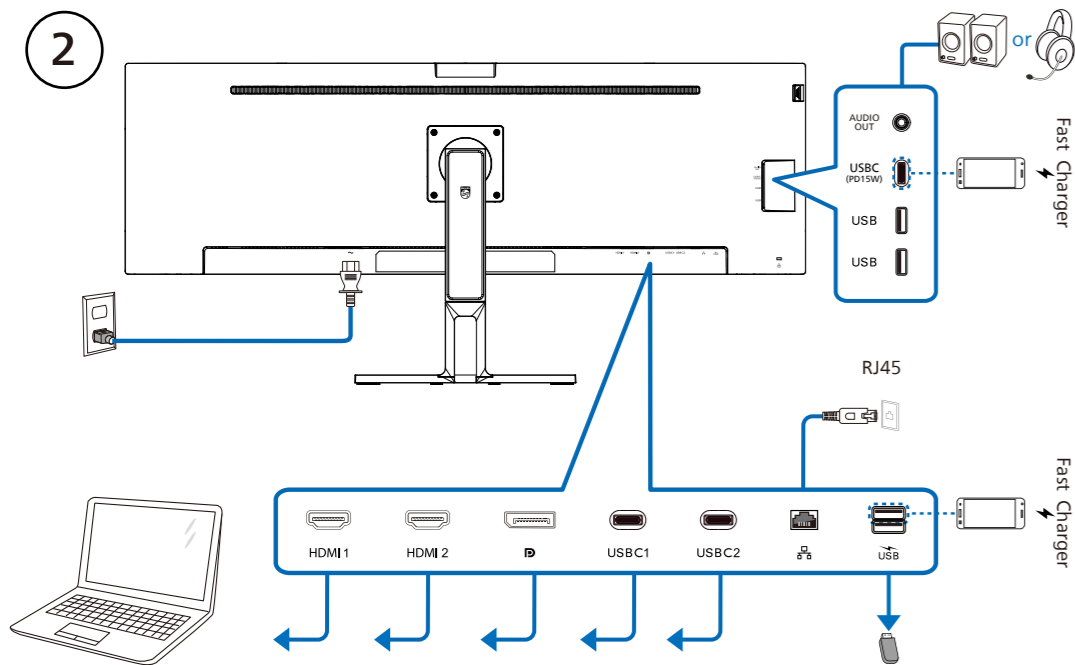

### USB docking (USB C-C)

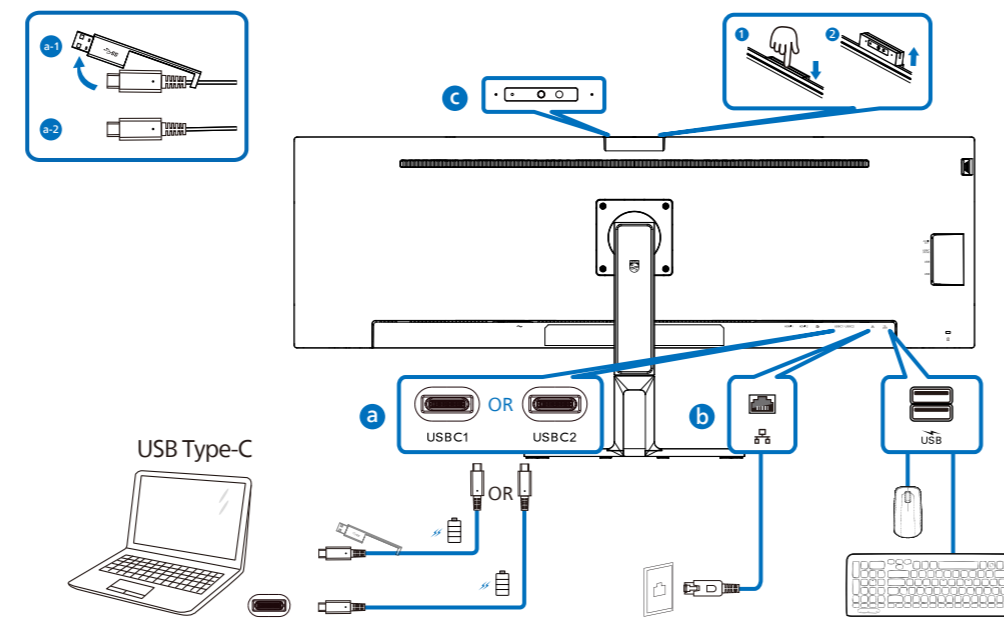

### USB hub (USB A-C)

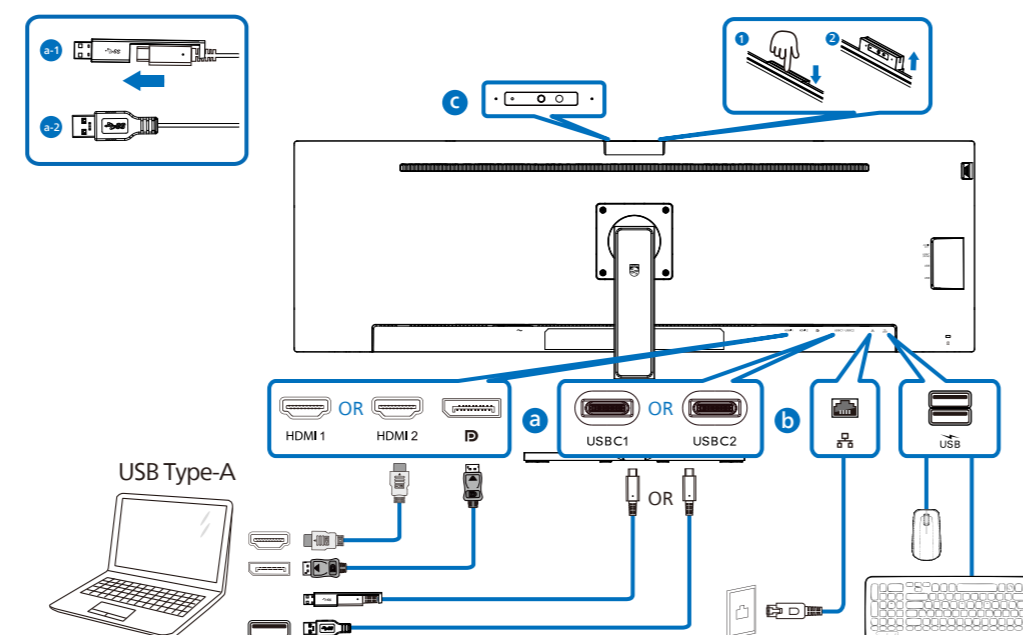

### KVM

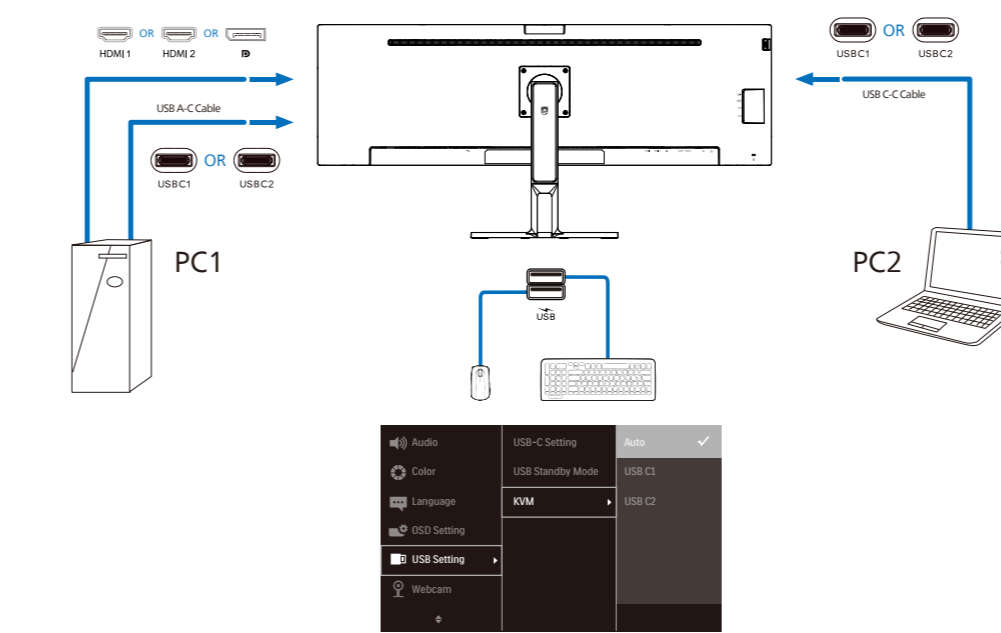

### Earphone-Hang

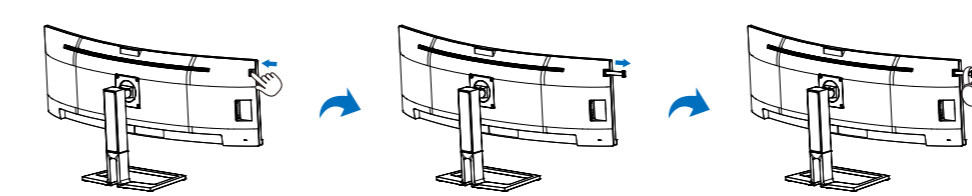

3

